

Sensor Fusion and Tracking Toolbox™

Reference



MATLAB® & SIMULINK®

R2021a



How to Contact MathWorks



Latest news: www.mathworks.com
Sales and services: www.mathworks.com/sales_and_services
User community: www.mathworks.com/matlabcentral
Technical support: www.mathworks.com/support/contact_us



Phone: 508-647-7000



The MathWorks, Inc.
1 Apple Hill Drive
Natick, MA 01760-2098

Sensor Fusion and Tracking Toolbox™ Reference Guide

© COPYRIGHT 2018 - 2021 by The MathWorks, Inc.

The software described in this document is furnished under a license agreement. The software may be used or copied only under the terms of the license agreement. No part of this manual may be photocopied or reproduced in any form without prior written consent from The MathWorks, Inc.

FEDERAL ACQUISITION: This provision applies to all acquisitions of the Program and Documentation by, for, or through the federal government of the United States. By accepting delivery of the Program or Documentation, the government hereby agrees that this software or documentation qualifies as commercial computer software or commercial computer software documentation as such terms are used or defined in FAR 12.212, DFARS Part 227.72, and DFARS 252.227-7014. Accordingly, the terms and conditions of this Agreement and only those rights specified in this Agreement, shall pertain to and govern the use, modification, reproduction, release, performance, display, and disclosure of the Program and Documentation by the federal government (or other entity acquiring for or through the federal government) and shall supersede any conflicting contractual terms or conditions. If this License fails to meet the government's needs or is inconsistent in any respect with federal procurement law, the government agrees to return the Program and Documentation, unused, to The MathWorks, Inc.

Trademarks

MATLAB and Simulink are registered trademarks of The MathWorks, Inc. See www.mathworks.com/trademarks for a list of additional trademarks. Other product or brand names may be trademarks or registered trademarks of their respective holders.

Patents

MathWorks products are protected by one or more U.S. patents. Please see www.mathworks.com/patents for more information.

Revision History

September 2018	Online only	New for Version 1.0 (Release 2018b)
March 2019	Online only	Revised for Version 1.1 (Release 2019a)
September 2019	Online only	Revised for Version 1.2 (Release 2019b)
March 2020	Online only	Revised for Version 1.3 (Release 2020a)
September 2020	Online only	Revised for Version 2.0 (Release 2020b)
March 2021	Online only	Revised for Version 2.1 (Release 2021a)

1	Functions
2	Classes
3	System Objects
4	Blocks
5	Apps

Functions

allanvar

Allan variance

Syntax

```
[avar,tau] = allanvar(Omega)
[avar,tau] = allanvar(Omega,m)
[avar,tau] = allanvar(Omega,ptStr)
[avar,tau] = allanvar(___,fs)
```

Description

Allan variance is used to measure the frequency stability of oscillation for a sequence of data in the time domain. It can also be used to determine the intrinsic noise in a system as a function of the averaging time. The averaging time series τ can be specified as $\tau = m/fs$. Here fs is the sampling frequency of data, and m is a list of ascending averaging factors (such as 1, 2, 4, 8, ...).

`[avar,tau] = allanvar(Omega)` returns the Allan variance `avar` as a function of averaging time `tau`. The default averaging time `tau` is an octave sequence given as $(1, 2, \dots, 2^{\lfloor \log_2[(N-1)/2] \rfloor})$, where N is the number of samples in `Omega`. If `Omega` is specified as a matrix, `allanvar` operates over the columns of `omega`.

`[avar,tau] = allanvar(Omega,m)` returns the Allan variance `avar` for specific values of `tau` defined by `m`. Since the default frequency `fs` is assumed to be 1, the output `tau` is exactly same with `m`.

`[avar,tau] = allanvar(Omega,ptStr)` sets averaging factor `m` to the specified point specification, `ptStr`. Since the default frequency `fs` is 1, the output `tau` is exactly equal to the specified `m`. `ptStr` can be specified as 'octave' or 'decade'.

`[avar,tau] = allanvar(___,fs)` also allows you to provide the sampling frequency `fs` of the input data `omega` in Hz. This input parameter can be used with any of the previous syntaxes.

Examples

Determine Allan Variance of Single Axis Gyroscope

Load gyroscope data from a MAT file, including the sample rate of the data in Hz. Calculate the Allan variance.

```
load('LoggedSingleAxisGyroscope','omega','Fs')
[avar,tau] = allanvar(omega,'octave',Fs);
```

Plot the Allan variance on a log log plot.

```
loglog(tau,avar)
xlabel('\tau')
ylabel('\sigma^2(\tau)')
title('Allan Variance')
grid on
```

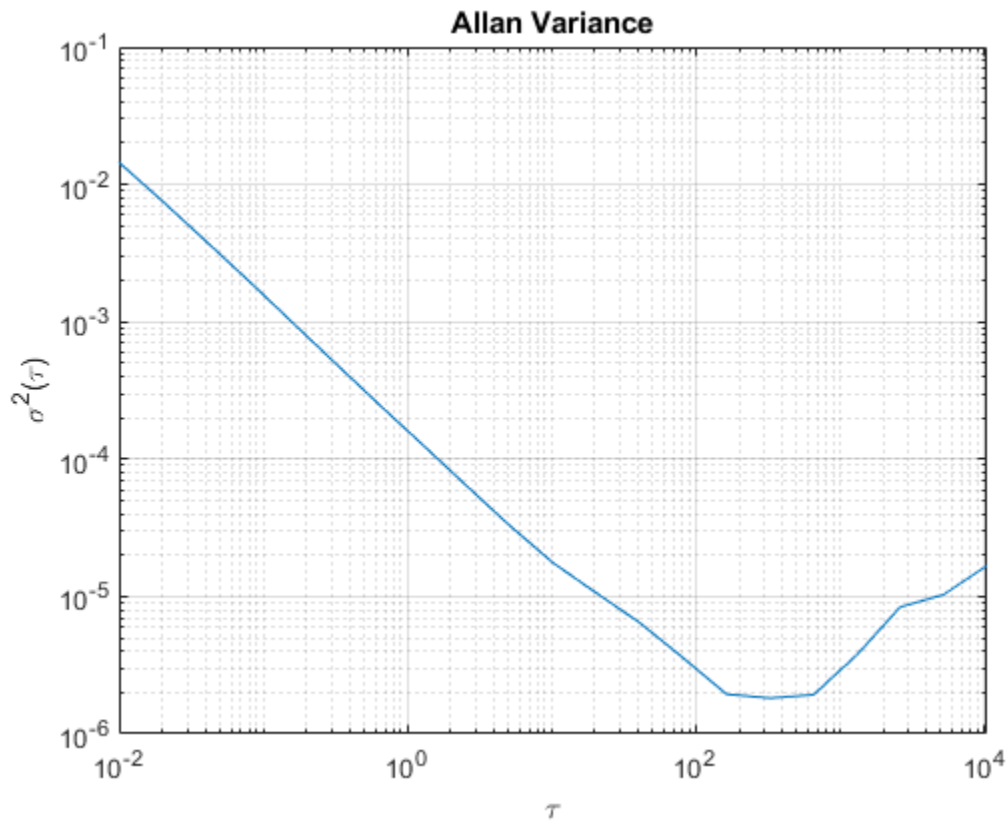

Determine Allan Deviation at Specific Values of τ

Generate sample gyroscope noise, including angle random walk and rate random walk.

```
numSamples = 1e6;
Fs = 100;
nStd = 1e-3;
kStd = 1e-7;
nNoise = nStd.*randn(numSamples,1);
kNoise = kStd.*cumsum(randn(numSamples,1));
omega = nNoise+kNoise;
```

Calculate the Allan deviation at specific values of $m = \tau$. The Allan deviation is the square root of the Allan variance.

```
m = 2.^(9:18);
[avar,tau] = allanvar(omega,m,Fs);
adev = sqrt(avar);
```

Plot the Allan deviation on a loglog plot.

```
loglog(tau,adev)
xlabel('\tau')
ylabel('\sigma(\tau)')
```

```
title('Allan Deviation')
grid on
```

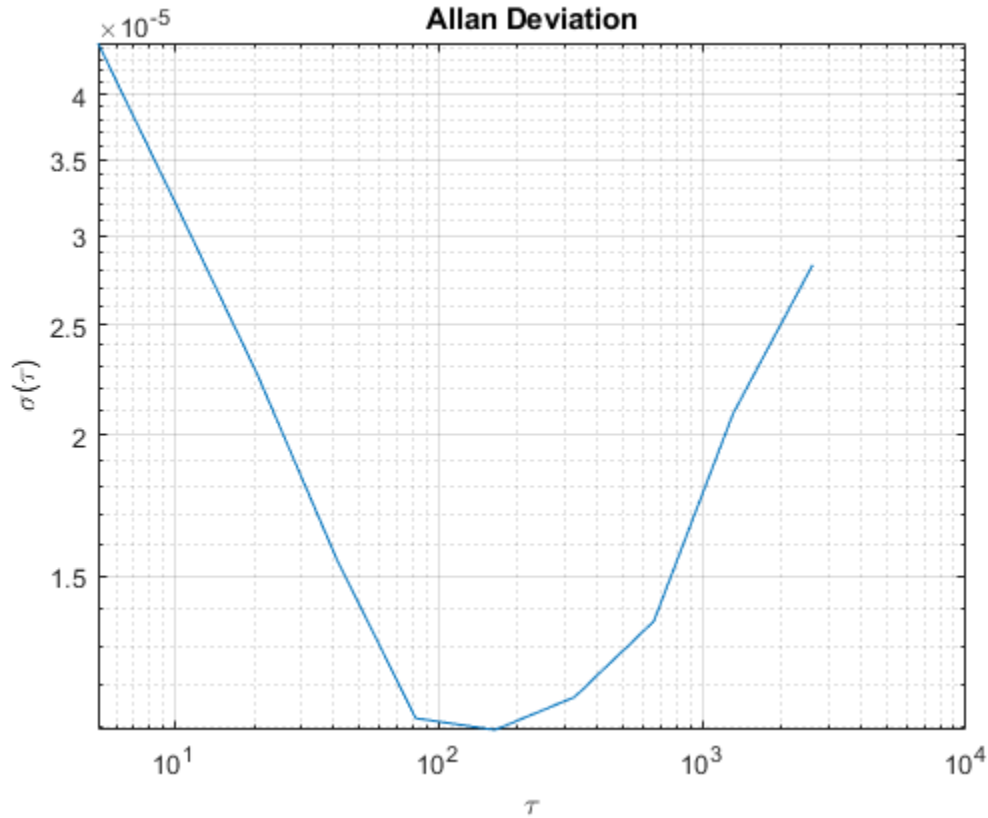

Input Arguments

Omega — Input data

N -by-1 vector | N -by- M matrix

Input data specified as an N -by-1 vector or an N -by- M matrix. N is the number of samples, and M is the number of sample sets. If specified as a matrix, `allanvar` operates over the columns of `Omega`.

Data Types: `single` | `double`

m — Averaging factor

scalar | vector

Averaging factor, specified as a scalar or vector with ascending integer values less than $(N-1)/2$, where N is the number of samples in `Omega`.

Data Types: `single` | `double`

ptStr — Point specification of m

'octave' (default) | 'decade'

Point specification of `m`, specified as 'octave' or 'decade'. Based on the value of `ptStr`, `m` is specified as following:

- If `ptStr` is specified as `'octave'`, `m` is:

$$\left[2^0, 2^1 \dots 2^{\left\lfloor \log_2\left(\frac{N-1}{2}\right) \right\rfloor} \right]$$

- If `ptStr` is specified as `'decade'`, `m` is:

$$\left[10^0, 10^1 \dots 10^{\left\lfloor \log_{10}\left(\frac{N-1}{2}\right) \right\rfloor} \right]$$

N is the number of samples in Ω .

fs — Basic frequency of input data in Hz

scalar

Basic frequency of the input data, Ω , in Hz, specified as a positive scalar.

Data Types: `single` | `double`

Output Arguments

avar — Allan variance of input data

vector | matrix

Allan variance of input data at `tau`, returned as a vector or matrix.

tau — Averaging time of Allan variance

vector | matrix

Averaging time of Allan variance, returned as a vector, or a matrix.

See Also

`gyroparams` | `imuSensor`

Introduced in R2019a

ctrect

Constant turn-rate rectangular target motion model

Syntax

```
updatedstates = ctrect(states)
updatedstates = ctrect(states,dt)
updatedstates = ctrect(states,w,dt)
```

Description

`updatedstates = ctrect(states)` returns the updated rectangular states from the current rectangular `states` based on the rectangular target motion model. The default time step is 1 second.

`updatedstates = ctrect(states,dt)` specifies the time step, `dt`, in seconds.

`updatedstates = ctrect(states,w,dt)` additionally specifies the process noise, `w`.

Examples

Predict Constant Turn-Rate Rectangular State

Define a rectangular state.

```
state = [1 2 2 30 1 4.7 1.8];
```

Predict the state `dt = 1` second forward using the default syntax.

```
state = ctrect(state,0.1)
```

```
state = 1×7
```

```
1.1731    2.1002    2.0000    30.1000    1.0000    4.7000    1.8000
```

Predict the state `dt = 0.1` second forward without noise.

```
state = ctrect(state,0.1)
```

```
state = 1×7
```

```
1.3461    2.2006    2.0000    30.2000    1.0000    4.7000    1.8000
```

Predict the state `dt = 0.1` second forward with noise.

```
state = ctrect(state,0.01,0.1)
```

```
state = 1×7
```

```
1.5189    2.3014    2.0010    30.3000    1.0010    4.7000    1.8000
```

Predict Multiple Constant Turn-Rate Rectangular States

Define a state matrix.

```
states = [1 3 4;-1 2 10;5 3 1.3;1 1.3 2.1;30 0 -30;4.7 3.4 4.5;1.8 2 3];
```

Predict the state $dt = 1$ second ahead.

```
states = ctrect(states)
```

```
states = 7×3
```

```
    5.7516    5.9992    5.2528
    0.3625    2.0681    9.7131
    5.0000    3.0000    1.3000
   31.0000    1.3000   -27.9000
   30.0000    0.0000   -30.0000
    4.7000    3.4000    4.5000
    1.8000    2.0000    3.0000
```

Predict the state $dt = 0.1$ second ahead without noise.

```
states = ctrect(states,0.1)
```

```
states = 7×3
```

```
    6.1732    6.2992    5.3660
    0.6311    2.0749    9.6493
    5.0000    3.0000    1.3000
   34.0000    1.3000   -30.9000
   30.0000    0.0000   -30.0000
    4.7000    3.4000    4.5000
    1.8000    2.0000    3.0000
```

Predict the state $dt = 0.1$ second ahead with noise.

```
states = ctrect(states,0.1*randn(2,3),0.1)
```

```
states = 7×3
```

```
    6.5805    6.5979    5.4759
    0.9216    2.0816    9.5795
    5.0054    2.9774    1.3032
   37.0009    1.3004   -33.9007
   30.0183    0.0086   -30.0131
    4.7000    3.4000    4.5000
    1.8000    2.0000    3.0000
```

Input Arguments

states — Current rectangular states

1-by-7 real-valued vector | 7-by-1 real-valued vector | 7-by-N real-valued matrix

Current rectangular states, specified as a 1-by-7 real-valued vector, 7-by-1 real-valued vector, or a 7-by- N real-valued matrix, where N is the number of states. The seven dimensional rectangular target state is defined as $[x; y; s; \theta; \omega; L; W]$:

Variable	Meaning	Unit
x	Position of the rectangle center in x direction	m
y	Position of the rectangle center in y direction	m
s	Speed in the heading direction	m/s
θ	Orientation angle of the rectangle with respect to x direction	degree
ω	Turn-rate	degree/s
L	Length of the rectangle	m
W	Width of the rectangle	m

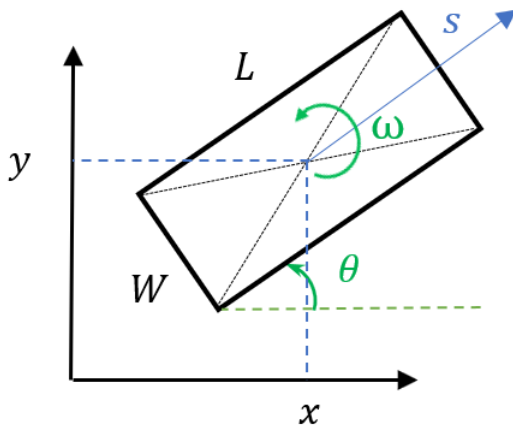

Example: $[1; 2; 2; 30; 1; 4.7; 1.8]$

Data Types: single | double

dt – Time step

real-valued positive scalar

Time step, specified as a real-valued positive scalar in second.

Data Types: single | double

w – Process noise

real scalar | 2-by- N real-valued matrix

Process noise, specified as a 2-by- N real-valued matrix, where N is the number of states specified in the states input. If specified as a scalar, it is expanded to a 2-by- N matrix with all elements equal to

the scalar. The first row of the matrix specifies the process noise in acceleration (m/s^2). The second row specifies the process noise in yaw acceleration (degrees/s^2).

Data Types: `single` | `double`

Output Arguments

updatedstates — Updated states

1-by-7 real-valued vector | 7-by-1 real-valued vector | 7-by- N real-valued matrix

Updated states, specified as a 1-by-7 real-valued vector, a 7-by-1 real-valued vector, or a 7-by- N real-valued matrix, where N is the number of states. The dimensions and setups of `updatedstates` output are exactly the same as those of the `states` input.

Data Types: `single` | `double`

Extended Capabilities

C/C++ Code Generation

Generate C and C++ code using MATLAB® Coder™.

See Also

`ctrectcorners` | `ctrectjac` | `ctrectmeas` | `ctrectmeasjac` | `gmphd` | `initctrectgmphd` | `trackerPHD`

Introduced in R2019b

ctrectmeas

Constant turn-rate rectangular target measurement model

Syntax

```
measurements = ctrectmeas(states,detections)
```

Description

`measurements = ctrectmeas(states,detections)` returns the expected measurements from the current rectangular states and detections.

Examples

Expected Detections Using Rectangular Measurement Model

Load detections and truth generated from a rectangular target.

```
load('rectangularTargetDetections.mat','detections','truthState');
```

Generate expected detections from the target's rectangular state and actual detections using `ctrectmeas`.

```
tgtState = [3;48;0;60;0;5;1.9];  
zExp = ctrectmeas(tgtState,detections);
```

Set up visualization environment using `theaterPlot`.

```
theaterP = theaterPlot;  
stateP = trackPlotter(theaterP,'DisplayName','State','MarkerFaceColor','g');  
truthP = trackPlotter(theaterP,'DisplayName','Truth','MarkerFaceColor','b');  
detP = detectionPlotter(theaterP,'DisplayName','Detections','MarkerFaceColor','r');  
expDetP = detectionPlotter(theaterP,'DisplayName','Expected Detections','MarkerFaceColor','y');  
l = legend(theaterP.Parent);  
l.AutoUpdate = 'on';  
hold on;  
assignP = plot(theaterP.Parent,NaN,NaN,'-.','DisplayName','Association');
```

Plot actual and expected detections.

```
inDets = [detections{:}];  
inMeas = horzcat(inDets.Measurement);  
detP.plotDetection(inMeas');
```

```
zExpPlot = reshape(zExp,3,[]);  
expDetP.plotDetection(zExpPlot');
```

Plot association lines.

```
zLines = nan(2,numel(detections)*3);  
zLines(1,1:3:end) = zExpPlot(1,:);
```

```

zLines(2,1:3:end) = zExpPlot(2,:);
zLines(1,2:3:end) = inMeas(1,:);
zLines(2,2:3:end) = inMeas(2,:);
assignP.XData = zLines(1,:);
assignP.YData = zLines(2,:);

```

Plot truth and state.

```

truthPos = [truthState(1:2);0];
truthDims = struct('Length',truthState(6),...
    'Width',truthState(7),...
    'Height', 0,...
    'OriginOffset', [0 0 0]);
truthOrient = quaternion([truthState(4) 0 0],'eulerd', 'ZYX','frame');
truthP.plotTrack(truthPos',truthDims,truthOrient);

statePos = [tgtState(1:2);0];
stateDims = struct('Length',tgtState(6),...
    'Width',tgtState(7),...
    'Height',0,...
    'OriginOffset', [0 0 0]);
stateOrient = quaternion([tgtState(4) 0 0],'eulerd', 'ZYX','frame');
stateP.plotTrack(statePos', stateDims, stateOrient);

```

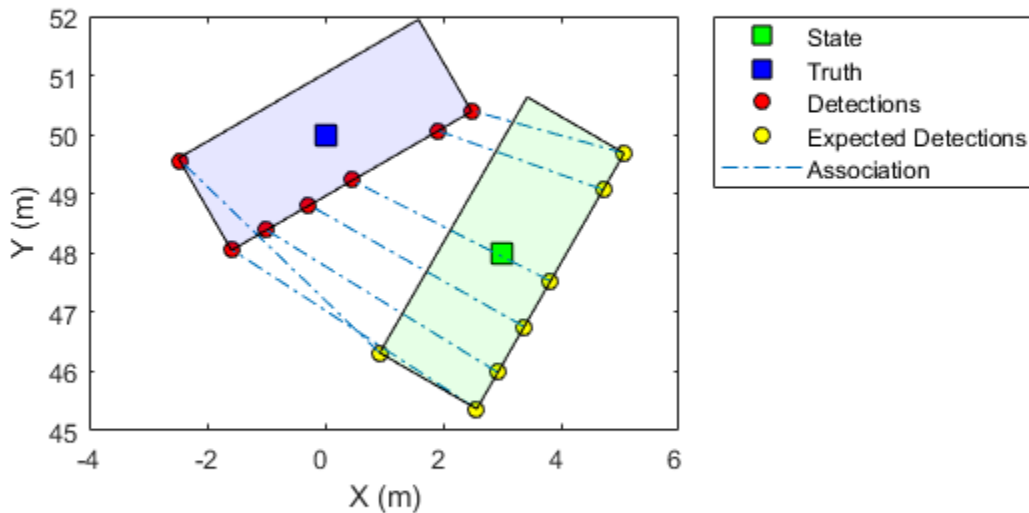

Input Arguments

states — Current rectangular states

7-by- N real-valued matrix

Current rectangular states, specified as a 7-by- N real-valued matrix, where N is the number of states. The seven-dimensional rectangular target state is defined as $[x; y; s; \theta; \omega; L; W]$:

Variable	Meaning	Unit
x	Position of the rectangle center in x direction	m
y	Position of the rectangle center in y direction	m
s	Speed in the heading direction	m/s
θ	Orientation angle of the rectangle with respect to x direction	degree
ω	Turn-rate	degree/s
L	Length of the rectangle	m
W	Width of the rectangle	m

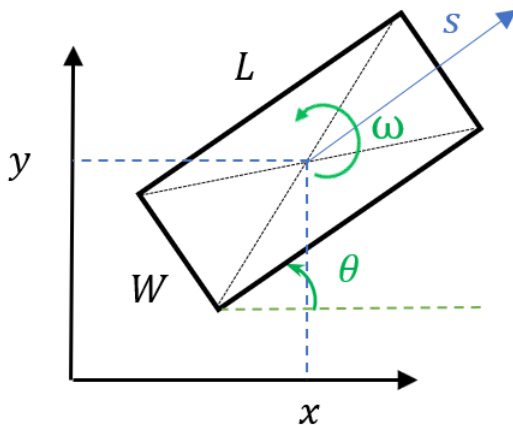

Example: `[1;2;2;30;1;4.7;1.8]`

Data Types: `single` | `double`

detections — Detections of target

1-by- M cell array of `objectDetection` objects

Detections of target, specified as a 1-by- M cell array of `objectDetection` objects. The `MeasurementParameters` property (that specifies the transformation from the state-space to measurement-space) for each object must be the same for all the detections in the cell array.

Output Arguments

measurements — Expected measurements

P-by-*N*-by-*M* real-valued array

Expected measurements, returned as a *P*-by-*N*-by-*M* real-valued array. *P* is the dimension of each measurement specified in the `detections` input, *N* is the number of states specified in the `states` input, and *M* is the number of detections specified in the `detections` input.

Extended Capabilities

C/C++ Code Generation

Generate C and C++ code using MATLAB® Coder™.

See Also

`ctrect` | `ctrectcorners` | `ctrectjac` | `ctrectmeasjac` | `gmphd` | `initctrectgmphd` | `trackerPHD`

Introduced in R2019b

ctrectmeasjac

Jacobian of constant turn-rate rectangular target measurement model

Syntax

```
jacobian = ctrectmeasjac(state,detections)
```

Description

`jacobian = ctrectmeasjac(state,detections)` returns the Jacobian based on the current rectangular target state and detections.

Examples

Generate Jacobian for Rectangular Target Model

Load detections generated from a rectangular target.

```
load('rectangularTargetDetections.mat','detections');
```

Calculate Jacobian based on the rectangular state of the target and detections.

```
tgtState = [3;48;0;60;0;5;1.9];
jac = ctrectmeasjac(tgtState,detections);
jac1 = jac(:,:,1)
```

```
jac1 = 3×7
```

```
    1.0000    0    0    0.0461    0   -0.2500    0.4330
    0    1.0000    0   -0.0075    0   -0.4330   -0.2500
    0    0    0    0    0    0    0
```

Input Arguments

state — Current rectangular target state

7-by-1 real-valued vector

Current rectangular target state, specified as a 7-by-1 real-valued vector. The seven dimensional rectangular target state is defined as $[x; y; s; \theta; \omega; L; W]$. The meaning of these variables and their units are:

Variable	Meaning	Unit
x	Position of the rectangle center in x direction	m
y	Position of the rectangle center in y direction	m

s	Speed in the heading direction	m/s
θ	Orientation angle of the rectangle with respect to x direction	degree
ω	Turn-rate	degree/s
L	Length of the rectangle	m
W	Width of the rectangle	m

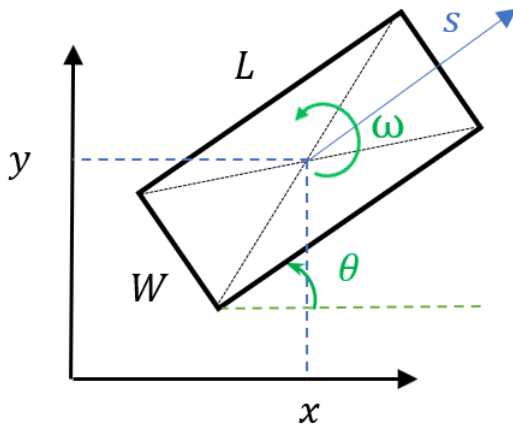

Example: [1;2;2;30;1;4.7;1.8]

Data Types: single | double

detections – Detections of target

1-by- M cell array of `objectDetection` objects

Detections of target, specified as a 1-by- M cell array of `objectDetection` objects. The `MeasurementParameters` property (that specifies the transformation from the state-space to measurement-space) for each object must be the same for all the detections in the cell array.

Output Arguments

jacobian – Jacobian of measurement model

M -by-7-by- D real-valued array

Jacobian of measurement model, returned as a M -by-7-by- D real-valued array. M is the dimension of each measurement specified in `detections`, and D is the number of detections specified in the `detections` input.

Extended Capabilities

C/C++ Code Generation

Generate C and C++ code using MATLAB® Coder™.

See Also

[ctrect](#) | [ctrectcorners](#) | [ctrectjac](#) | [ctrectmeas](#) | [gmphd](#) | [initctrectgmphd](#) | [trackerPHD](#)

Introduced in R2019b

ctrectjac

Jacobian of constant turn-rate rectangular target motion model

Syntax

```
Jx = ctrectjac(state)
Jx = ctrectjac(state,dt)
[Jx,Jw] = ctrectjac(state,w,dt)
```

Description

`Jx = ctrectjac(state)` returns the Jacobian matrix of the constant turn-rate rectangular motion model with respect to the state vector. The default time step is 1 second.

`Jx = ctrectjac(state,dt)` specifies the time step `dt` in seconds.

`[Jx,Jw] = ctrectjac(state,w,dt)` also specifies the process noise `w`.

Examples

Jacobian of Constant Turn-Rate Rectangular Motion Model

Define a state vector for the model.

```
state = [1;2;2;30;1;4.7;1.8];
```

Compute the Jacobian. `dt = 1` second.

```
jac = ctrectjac(state)
```

```
jac = 7×7
```

```

1.0000    0    0.8616   -0.0177   -0.0089    0    0
    0    1.0000    0.5075    0.0301    0.0150    0    0
    0    0    1.0000    0    0    0    0
    0    0    0    1.0000    1.0000    0    0
    0    0    0    0    1.0000    0    0
    0    0    0    0    0    1.0000    0
    0    0    0    0    0    0    1.0000
```

Compute the Jacobian. `dt = 0.1` second without noise.

```
jac = ctrectjac(state,0.1)
```

```
jac = 7×7
```

```

1.0000    0    0.0866   -0.0017   -0.0001    0    0
    0    1.0000    0.0501    0.0030    0.0002    0    0
    0    0    1.0000    0    0    0    0
    0    0    0    1.0000    0.1000    0    0
```

```

0      0      0      0      1.0000      0      0
0      0      0      0      0      1.0000      0
0      0      0      0      0      0      1.0000

```

Compute the Jacobian. dt = 0.1 second with noise.

```
jac = ctrextjac(state,0.01,0.1)
```

```
jac = 7x7
```

```

1.0000      0      0.0866 -0.0017 -0.0001      0      0
0      1.0000      0.0501 0.0030 0.0002      0      0
0      0      1.0000      0      0      0      0
0      0      0      1.0000      0.1000      0      0
0      0      0      0      1.0000      0      0
0      0      0      0      0      1.0000      0
0      0      0      0      0      0      1.0000

```

Input Arguments

state – Current state

1-by-7 real-valued vector

Current state, specified as a 1-by-7 real-valued vector. The state of the constant-turn rectangular target model is $[x; y; s; \theta; \omega; L; W]$. The meaning of these variables and their units are:

Variable	Meaning	Unit
x	Position of the rectangle center in x direction	m
y	Position of the rectangle center in y direction	m
s	Speed in the heading direction	m/s
θ	Orientation angle of the rectangle with respect to x direction	degree
ω	Turn-rate	degree/s
L	Length of the rectangle	m
W	Width of the rectangle	m

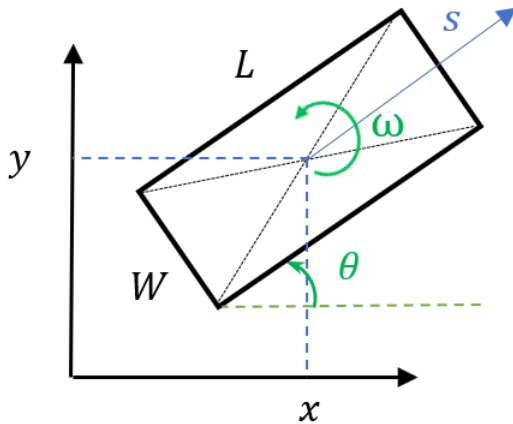

Example: [1;2;2;30;1;4.7;1.8]

Data Types: single | double

dt — Time step

real-valued positive scalar

Time step, specified as a real-valued positive scalar in second.

Data Types: single | double

w — Process noise

real scalar | 2-element real-valued vector

Process noise, specified as a 2-element real-valued vector. The first element specifies the process noise in linear acceleration (m/s^2). The second element specifies the process noise in yaw acceleration (degrees/s^2).

Data Types: single | double

Output Arguments

Jx — Jacobian matrix with respect to state

7-by-7 matrix

Jacobian matrix with respect to state, returned as a 7-by-7 matrix.

Data Types: double

Jw — Jacobian with respect to process noise

7-by-2 matrix

Jacobian with respect to process noise, returned as a 7-by-2 matrix.

Data Types: double

Extended Capabilities

C/C++ Code Generation

Generate C and C++ code using MATLAB® Coder™.

See Also

`ctrect` | `ctrectcorners` | `ctrectmeas` | `ctrectmeasjac` | `gmphd` | `initctrectgmphd` | `trackerPHD`

Introduced in R2019b

jpdaEvents

Feasible joint events for trackerJPDA

Syntax

```
FJE = jpdaEvents(validationMatrix)
[FJE,FJEProbs] = jpdaEvents(likelihoodMatrix,k)
```

Description

`FJE = jpdaEvents(validationMatrix)` returns the feasible joint events, FJE, based on the validation matrix. A validation matrix describes the possible associations between detections and tracks, whereas a feasible joint event for multi-object tracking is one realization of the associations between detections and tracks.

`[FJE,FJEProbs] = jpdaEvents(likelihoodMatrix,k)` generates the k-best feasible joint event matrices, FJE, corresponding to the posterior likelihood matrix, `likelihoodMatrix`. `likelihoodMatrix` defines the posterior likelihood of associating detections with tracks.

Examples

Generate Feasible Joint Events

Define an arbitrary validation matrix for five measurements and six tracks.

```
M = [1    1    1    1    1    0    1
      1    0    1    1    0    0    0
      1    0    0    0    1    1    0
      1    1    1    1    0    0    0
      1    1    1    1    1    1    1];
```

Generate all feasible joint events and count the total number.

```
FJE = jpdaEvents(M);
nFJE = size(FJE,3);
```

Display a few of the feasible joint events.

```
disp([num2str(nFJE) ' feasible joint event matrices were generated.'])
```

574 feasible joint event matrices were generated.

```
toSee = [1:round(nFJE/5):nFJE, nFJE];
for ii = toSee
    disp("Feasible joint event matrix #" + ii + ":")
    disp(FJE(:,:,ii))
end
```

Feasible joint event matrix #1:

```
1 0 0 0 0 0 0
1 0 0 0 0 0 0
1 0 0 0 0 0 0
1 0 0 0 0 0 0
1 0 0 0 0 0 0
```

Feasible joint event matrix #116:

```
0 0 1 0 0 0 0
1 0 0 0 0 0 0
0 0 0 0 1 0 0
0 1 0 0 0 0 0
0 0 0 1 0 0 0
```

Feasible joint event matrix #231:

```
0 0 0 0 1 0 0
0 0 1 0 0 0 0
0 0 0 0 0 1 0
1 0 0 0 0 0 0
0 0 0 0 0 0 1
```

Feasible joint event matrix #346:

```
0 0 0 0 0 0 1
0 0 0 1 0 0 0
0 0 0 0 1 0 0
1 0 0 0 0 0 0
0 1 0 0 0 0 0
```

Feasible joint event matrix #461:

```
1 0 0 0 0 0 0
0 0 1 0 0 0 0
1 0 0 0 0 0 0
0 0 0 1 0 0 0
0 0 0 0 0 0 1
```

Feasible joint event matrix #574:

```
1 0 0 0 0 0 0
1 0 0 0 0 0 0
1 0 0 0 0 0 0
1 0 0 0 0 0 0
0 0 0 0 0 0 1
```

Obtain Feasible Joint Events from Likelihood Matrix

Create a likelihood matrix assuming four detections and two tracks.

```
likeMatrix = [0.1 0.1 0.1;
              0.1 0.3 0.2;
              0.1 0.4 0.1;
              0.1 0.6 0.1;
              0.1 0.5 0.3];
```

Generate three most probable events and obtain their normalized probabilities.

```
[FJE,FJEProbs] = jpdaEvents(likeMatrix,3)
```

```
FJE = 4x3x3 logical array
```

```
FJE(:,:,1) =
```

```

1  0  0
1  0  0
0  1  0
0  0  1
```

```
FJE(:,:,2) =
```

```

0  0  1
1  0  0
0  1  0
1  0  0
```

```
FJE(:,:,3) =
```

```

1  0  0
0  1  0
1  0  0
0  0  1
```

```
FJEProbs = 3x1
```

```

0.4286
0.2857
0.2857
```

Input Arguments

validationMatrix — Validation matrix

m -by- $(n+1)$ matrix

Validation matrix, specified as an m -by- $(n+1)$ matrix, where m is the number of detections within the cluster of a sensor scan, and n is the number of tracks maintained in the tracker. The validation matrix uses the first column to account for the possibility that each detection is clutter or false alarm, which is commonly referred to as "Track 0" or T_0 . The validation matrix is a binary matrix listing all possible detections-to-track associations. If it is possible to assign track T_i to detection D_j , then the $(j, i+1)$ entry of the validation matrix is 1. Otherwise, the entry is 0.

Data Types: `logical`

likelihoodMatrix — Likelihood matrix

$(m+1)$ -by- $(n+1)$ matrix

Likelihood matrix, specified as an $(m+1)$ -by- $(n+1)$ matrix, where m is the number of detections within the cluster of a sensor scan, and n is the number of tracks maintained in the tracker. The likelihood matrix uses the first column to account for the possibility that each detection is clutter or false alarm, which is commonly referred to as "Track 0" or T_0 . The matrix uses the first row to account for the

possibility that each track is not assigned to any detection, which can be referred to as "Detection 0" or D_0 . The $(j+1,i+1)$ element of the matrix represents the likelihood to assign track T_i to detection D_j .

Data Types: `logical`

k – Number of joint probabilistic events

positive integer

Number of joint probabilistic events, specified as a positive integer.

Data Types: `logical`

Output Arguments

FJE – Feasible joint events

m -by- $(n+1)$ -by- p array

Feasible joint events, specified as an m -by- $(n+1)$ -by- p array, where m is the number of detections within the cluster of a sensor scan, n is the number of tracks maintained in the tracker, and p is the total number of feasible joint events. Each page (an m -by- $(n+1)$ matrix) of FJE corresponds to one possible association between all the tracks and detections. The feasible joint event matrix on each page satisfies:

- The matrix has exactly one "1" value per row.
- Except for the first column, which maps to clutter, there can be at most one "1" per column.

For more details on feasible joint events, see "Feasible Joint Events" on page 1-24.

Data Types: `logical`

FJEProbs – Probabilities of feasible joint events

p -by-1 vector of nonnegative scalars

Probabilities of feasible joint events, returned as a p -by-1 vector of nonnegative scalars. The summation of these scalars is equal to 1. The k -th element represents the probability of the k -th joint events (specified in the FJE output argument) normalized over the p feasible joint events.

Data Types: `logical`

More About

Feasible Joint Events

In the typical workflow for a tracking system, the tracker needs to determine if a detection can be associated with any of the existing tracks. If the tracker only maintains one track, the assignment can be done by evaluating the validation gate around the predicted measurement and deciding if the measurement falls within the *validation gate*. In the measurement space, the validation gate is a spatial boundary, such as a 2-D ellipse or a 3-D ellipsoid, centered at the predicted measurement. The validation gate is defined using the probability information (state estimation and covariance, for example) of the existing track, such that the correct or ideal detections have high likelihood (97% probability, for example) of falling within this validation gate.

However, if a tracker maintains multiple tracks, the data association process becomes more complicated, because one detection can fall within the validation gates of multiple tracks. For example, in the following figure, tracks T_1 and T_2 are actively maintained in the tracker, and each of

them has its own validation gate. Since the detection D_2 is in the intersection of the validation gates of both T_1 and T_2 , the two tracks (T_1 and T_2) are connected and form a *cluster*. A cluster is a set of connected tracks and their associated detections.

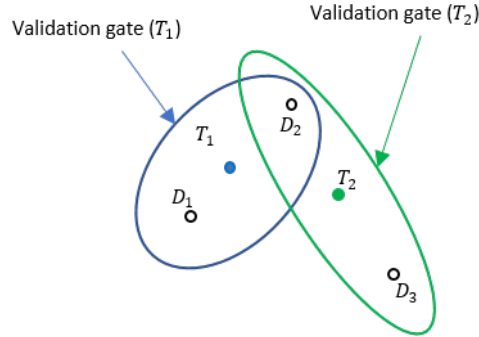

To represent the association relationship in a cluster, the validation matrix is commonly used. Each row of the validation matrix corresponds to a detection while each column corresponds to a track. To account for the eventuality of each detection being clutter, a first column is added and usually referred to as "Track 0" or T_0 . If detection D_i is inside the validation gate of track T_j , then the $(j, i+1)$ entry of the validation matrix is 1. Otherwise, it is zero. For the cluster shown in the figure, the validation matrix Ω is

$$\Omega = \begin{bmatrix} 1 & 1 & 0 \\ 1 & 1 & 1 \\ 1 & 0 & 1 \end{bmatrix}$$

Note that all the elements in the first column of Ω are 1, because any detection can be clutter or false alarm. One important step in the logic of joint probabilistic data association (JPDA) is to obtain all the feasible independent joint events in a cluster. Two assumptions for the feasible joint events are:

- A detection cannot be emitted by more than one track.
- A track cannot be detected more than once by the sensor during a single scan.

Based on these two assumptions, feasible joint events (FJEs) can be formulated. Each FJE is mapped to an FJE matrix Ω_p from the initial validation matrix Ω . For example, with the validation matrix Ω , eight FJE matrices can be obtained:

$$\begin{aligned} \Omega_1 &= \begin{bmatrix} 1 & 0 & 0 \\ 1 & 0 & 0 \\ 1 & 0 & 0 \end{bmatrix}, & \Omega_2 &= \begin{bmatrix} 0 & 1 & 0 \\ 1 & 0 & 0 \\ 1 & 0 & 0 \end{bmatrix}, & \Omega_3 &= \begin{bmatrix} 1 & 0 & 0 \\ 0 & 1 & 0 \\ 1 & 0 & 0 \end{bmatrix}, & \Omega_4 &= \begin{bmatrix} 1 & 0 & 0 \\ 0 & 0 & 1 \\ 1 & 0 & 0 \end{bmatrix} \\ \Omega_5 &= \begin{bmatrix} 0 & 1 & 0 \\ 0 & 0 & 1 \\ 1 & 0 & 0 \end{bmatrix}, & \Omega_6 &= \begin{bmatrix} 1 & 0 & 0 \\ 1 & 0 & 0 \\ 0 & 0 & 1 \end{bmatrix}, & \Omega_7 &= \begin{bmatrix} 0 & 1 & 0 \\ 1 & 0 & 0 \\ 0 & 0 & 1 \end{bmatrix}, & \Omega_8 &= \begin{bmatrix} 1 & 0 & 0 \\ 0 & 1 & 0 \\ 0 & 0 & 1 \end{bmatrix} \end{aligned}$$

As a direct consequence of the two assumptions, the Ω_p matrices have exactly one "1" value per row. Also, except for the first column which maps to clutter, there can be at most one "1" per column. When the number of connected tracks grows in a cluster, the number of FJE increases rapidly. The `jpdaEvents` function uses an efficient depth-first search algorithm to generate all the feasible joint event matrices.

References

- [1] Zhou, Bin, and N. K. Bose. "*Multitarget tracking in clutter: Fast algorithms for data association.*" IEEE Transactions on aerospace and electronic systems 29, no. 2 (1993): 352-363.
- [2] Fisher, James L., and David P. Casasent. "*Fast JPDA multitarget tracking algorithm.*" Applied optics 28, no. 2 (1989): 371-376.

Extended Capabilities

C/C++ Code Generation

Generate C and C++ code using MATLAB® Coder™.

Usage notes and limitations:

- This function only supports double precision code generation.

See Also

trackerJPDA

Introduced in R2019a

tunernoise

Noise structure of fusion filter

Syntax

```
noiseStruct = tunernoise(filterName)
```

Description

`noiseStruct = tunernoise(filterName)` returns the measurement noise structure for the filter with name specified by the `filterName` input.

Examples

Obtain Measurement Noise Structure of `insfilterAsync`

Obtain the measurement noise structure of the `insfilterAsync` object.

```
noiseStruct = tunernoise('insfilterAsync')
```

```
noiseStruct = struct with fields:
```

```
AccelerometerNoise: 1  
GyroscopeNoise: 1  
MagnetometerNoise: 1  
GPSPositionNoise: 1  
GPSVelocityNoise: 1
```

Tune `insfilterAsync` to Optimize Pose Estimate

Load the recorded sensor data and ground truth data.

```
load('insfilterAsyncTuneData.mat');
```

Create timetables for the sensor data and the truth data.

```
sensorData = timetable(Accelerometer, Gyroscope, ...  
    Magnetometer, GPSPosition, GPSVelocity, 'SampleRate', 100);  
groundTruth = timetable(Orientation, Position, ...  
    'SampleRate', 100);
```

Create an `insfilterAsync` filter object that has a few noise properties.

```
filter = insfilterAsync('State', initialState, ...  
    'StateCovariance', initialStateCovariance, ...  
    'AccelerometerBiasNoise', 1e-7, ...  
    'GyroscopeBiasNoise', 1e-7, ...  
    'MagnetometerBiasNoise', 1e-7, ...  
    'GeomagneticVectorNoise', 1e-7);
```

Create a tuner configuration object for the filter. Set the maximum iterations to two. Also, set the tunable parameters as the unspecified properties.

```
config = tunerconfig('insfilterAsync','MaxIterations',8);
config.TunableParameters = setdiff(config.TunableParameters, ...
    {'GeomagneticVectorNoise', 'AccelerometerBiasNoise', ...
    'GyroscopeBiasNoise', 'MagnetometerBiasNoise'});
config.TunableParameters

ans = 1x10 string
    "AccelerationNoise"    "AccelerometerNoise"    "AngularVelocityNoise"    "GPSPositionNoise"
```

Use the tuner noise function to obtain a set of initial sensor noises used in the filter.

```
measNoise = tunernoise('insfilterAsync')

measNoise = struct with fields:
    AccelerometerNoise: 1
    GyroscopeNoise: 1
    MagnetometerNoise: 1
    GPSPositionNoise: 1
    GPSVelocityNoise: 1
```

Tune the filter and obtain the tuned parameters.

```
tunedParams = tune(filter,measNoise,sensorData,groundTruth,config);
```

Iteration	Parameter	Metric
1	AccelerationNoise	2.1345
1	AccelerometerNoise	2.1264
1	AngularVelocityNoise	1.9659
1	GPSPositionNoise	1.9341
1	GPSVelocityNoise	1.8420
1	GyroscopeNoise	1.7589
1	MagnetometerNoise	1.7362
1	PositionNoise	1.7362
1	QuaternionNoise	1.7218
1	VelocityNoise	1.7218
2	AccelerationNoise	1.7190
2	AccelerometerNoise	1.7170
2	AngularVelocityNoise	1.6045
2	GPSPositionNoise	1.5948
2	GPSVelocityNoise	1.5323
2	GyroscopeNoise	1.4803
2	MagnetometerNoise	1.4703
2	PositionNoise	1.4703
2	QuaternionNoise	1.4632
2	VelocityNoise	1.4632
3	AccelerationNoise	1.4596
3	AccelerometerNoise	1.4548
3	AngularVelocityNoise	1.3923
3	GPSPositionNoise	1.3810
3	GPSVelocityNoise	1.3322
3	GyroscopeNoise	1.2998
3	MagnetometerNoise	1.2976
3	PositionNoise	1.2976

3	QuaternionNoise	1.2943
3	VelocityNoise	1.2943
4	AccelerationNoise	1.2906
4	AccelerometerNoise	1.2836
4	AngularVelocityNoise	1.2491
4	GPSPositionNoise	1.2258
4	GPSVelocityNoise	1.1880
4	GyroscopeNoise	1.1701
4	MagnetometerNoise	1.1698
4	PositionNoise	1.1698
4	QuaternionNoise	1.1688
4	VelocityNoise	1.1688
5	AccelerationNoise	1.1650
5	AccelerometerNoise	1.1569
5	AngularVelocityNoise	1.1454
5	GPSPositionNoise	1.1100
5	GPSVelocityNoise	1.0778
5	GyroscopeNoise	1.0709
5	MagnetometerNoise	1.0675
5	PositionNoise	1.0675
5	QuaternionNoise	1.0669
5	VelocityNoise	1.0669
6	AccelerationNoise	1.0634
6	AccelerometerNoise	1.0549
6	AngularVelocityNoise	1.0549
6	GPSPositionNoise	1.0180
6	GPSVelocityNoise	0.9866
6	GyroscopeNoise	0.9810
6	MagnetometerNoise	0.9775
6	PositionNoise	0.9775
6	QuaternionNoise	0.9768
6	VelocityNoise	0.9768
7	AccelerationNoise	0.9735
7	AccelerometerNoise	0.9652
7	AngularVelocityNoise	0.9652
7	GPSPositionNoise	0.9283
7	GPSVelocityNoise	0.8997
7	GyroscopeNoise	0.8947
7	MagnetometerNoise	0.8920
7	PositionNoise	0.8920
7	QuaternionNoise	0.8912
7	VelocityNoise	0.8912
8	AccelerationNoise	0.8885
8	AccelerometerNoise	0.8811
8	AngularVelocityNoise	0.8807
8	GPSPositionNoise	0.8479
8	GPSVelocityNoise	0.8238
8	GyroscopeNoise	0.8165
8	MagnetometerNoise	0.8165
8	PositionNoise	0.8165
8	QuaternionNoise	0.8159
8	VelocityNoise	0.8159

Fuse the sensor data using the tuned filter.

```
dt = seconds(diff(groundTruth.Time));
N = size(sensorData,1);
qEst = quaternion.zeros(N,1);
```

```
posEst = zeros(N,3);
% Iterate the filter for prediction and correction using sensor data.
for ii=1:N
    if ii ~= 1
        predict(filter, dt(ii-1));
    end
    if all(~isnan(Accelerometer(ii,:)))
        fuseaccel(filter, Accelerometer(ii,:), ...
            tunedParams.AccelerometerNoise);
    end
    if all(~isnan(Gyroscope(ii,:)))
        fusegyro(filter, Gyroscope(ii,:), ...
            tunedParams.GyroscopeNoise);
    end
    if all(~isnan(Magnetometer(ii,1)))
        fusemag(filter, Magnetometer(ii,:), ...
            tunedParams.MagnetometerNoise);
    end
    if all(~isnan(GPSPosition(ii,1)))
        fusegps(filter, GPSPosition(ii,:), ...
            tunedParams.GPSPositionNoise, GPSVelocity(ii,:), ...
            tunedParams.GPSVelocityNoise);
    end
    [posEst(ii,:), qEst(ii,:)] = pose(filter);
end
```

Compute the RMS errors.

```
orientationError = rad2deg(dist(qEst, Orientation));
rmsorientationError = sqrt(mean(orientationError.^2))

rmsorientationError = 2.7801

positionError = sqrt(sum((posEst - Position).^2, 2));
rmspositionError = sqrt(mean( positionError.^2))

rmspositionError = 0.5966
```

Visualize the results.

```
figure();
t = (0:N-1)./ groundTruth.Properties.SampleRate;
subplot(2,1,1)
plot(t, positionError, 'b');
title("Tuned insfilterAsync" + newline + "Euclidean Distance Position Error")
xlabel('Time (s)');
ylabel('Position Error (meters)')
subplot(2,1,2)
plot(t, orientationError, 'b');
title("Orientation Error")
xlabel('Time (s)');
ylabel('Orientation Error (degrees)');
```

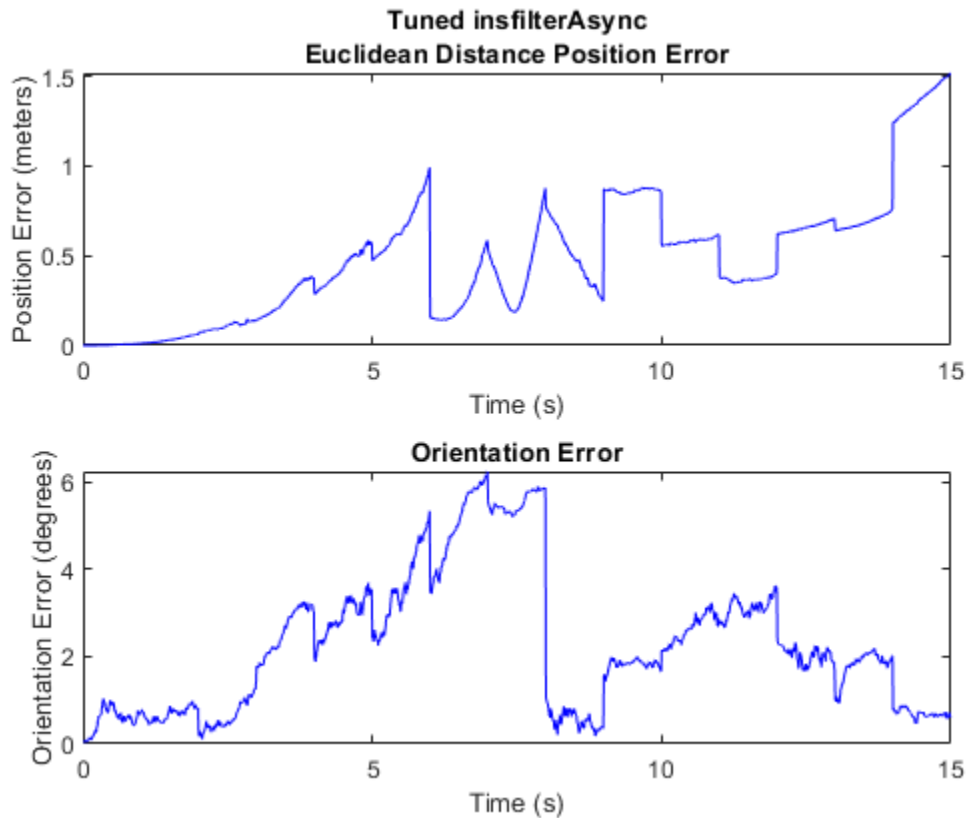

Input Arguments

filterName — Name of fusion filter

'insfilterAsync' | 'ahrs10filter' | 'insfilterMARG' | 'insfilterNonholonomic' | 'insfilterErrorState'

Name of fusion filter, specified as specified as one of these:

- 'ahrs10filter'
- 'insfilterAsync'
- 'insfilterMARG'
- 'insfilterErrorState'
- 'insfilterNonholonomic'

Output Arguments

noiseStruct — Structure of measurement noise

structure

Structure of measurement noise, returned as a structure. For the `insfilterAsync` object, the structure contains these fields.

Field	Description	Default
AccelerometerNoise	Variance of accelerometer noise, specified as a scalar in $(\text{m}^2/\text{s})^2$	1
GyroscopeNoise	Variance of gyroscope noise, specified as a scalar in $(\text{rad}/\text{s})^2$	1
MagnetometerNoise	Variance of magnetometer noise, specified as a scalar in $(\mu\text{T})^2$.	1
GPSPositionNoise	Variance of GPS position noise, specified as a scalar in m^2	1
GPSVelocityNoise	Standard deviation of GPS velocity noise, specified as a scalar in $(\text{m}/\text{s})^2$	1

To use this structure with the `tune` function, change the values of the noise to proper values as initial guesses for tuning the noise.

See Also

Introduced in R2020b

insfilter

Create inertial navigation filter

Syntax

```
filter = insfilter
filter = insfilter('ReferenceFrame',RF)
```

Description

`filter = insfilter` returns an `insfilterMARG` inertial navigation filter object that estimates pose based on accelerometer, gyroscope, GPS, and magnetometer measurements. See `insfilterMARG` for more details.

`filter = insfilter('ReferenceFrame',RF)` returns an `insfilterMARG` inertial navigation filter object that estimates pose relative to a reference frame specified by RF. Specify RF as 'NED' (North-East-Down) or 'ENU' (East-North-Up). The default value is 'NED'. See `insfilterMARG` for more details.

Examples

Create Default INS Filter

The default INS filter is the `insfilterMARG` object. Call `insfilter` with no input arguments to create the default INS filter.

```
filter = insfilter
```

```
filter =
  insfilterMARG with properties:

      IMUSampleRate: 100                Hz
  ReferenceLocation: [0 0 0]            [deg deg m]
           State: [22x1 double]
  StateCovariance: [22x22 double]

  Multiplicative Process Noise Variances
      GyroscopeNoise: [1e-09 1e-09 1e-09] (rad/s)2
      AccelerometerNoise: [0.0001 0.0001 0.0001] (m/s2)2
      GyroscopeBiasNoise: [1e-10 1e-10 1e-10] (rad/s)2
      AccelerometerBiasNoise: [0.0001 0.0001 0.0001] (m/s2)2

  Additive Process Noise Variances
      GeomagneticVectorNoise: [1e-06 1e-06 1e-06] uT2
      MagnetometerBiasNoise: [0.1 0.1 0.1] uT2
```

Extended Capabilities

C/C++ Code Generation

Generate C and C++ code using MATLAB® Coder™.

See Also

[ahrsfilter](#) | [imufilter](#) | [insfilterAsync](#) | [insfilterErrorState](#) | [insfilterMARG](#) | [insfilterNonholonomic](#)

Topics

“Estimate Position and Orientation of a Ground Vehicle”

Introduced in R2018b

ecompass

Orientation from magnetometer and accelerometer readings

Syntax

```
orientation = ecompass(accelerometerReading,magnetometerReading)
orientation = ecompass(accelerometerReading,magnetometerReading,
orientationFormat)
orientation = ecompass(accelerometerReading,magnetometerReading,
orientationFormat,'ReferenceFrame',RF)
```

Description

`orientation = ecompass(accelerometerReading,magnetometerReading)` returns a quaternion that can rotate quantities from a parent (NED) frame to a child (sensor) frame.

`orientation = ecompass(accelerometerReading,magnetometerReading,orientationFormat)` specifies the orientation format as quaternion or rotation matrix.

`orientation = ecompass(accelerometerReading,magnetometerReading,orientationFormat,'ReferenceFrame',RF)` also allows you to specify the reference frame RF of the orientation output. Specify RF as 'NED' (North-East-Down) or 'ENU' (East-North-Up). The default value is 'NED'.

Examples

Determine Declination of Boston

Use the known magnetic field strength and proper acceleration of a device pointed true north in Boston to determine the magnetic declination of Boston.

Define the known acceleration and magnetic field strength in Boston.

```
magneticFieldStrength = [19.535 -5.109 47.930];
properAcceleration = [0 0 9.8];
```

Pass the magnetic field strength and acceleration to the `ecompass` function. The `ecompass` function returns a quaternion rotation operator. Convert the quaternion to Euler angles in degrees.

```
q = ecompass(properAcceleration,magneticFieldStrength);
e = eulerd(q,'ZYX','frame');
```

The angle, `e`, represents the angle between true north and magnetic north in Boston. By convention, magnetic declination is negative when magnetic north is west of true north. Negate the angle to determine the magnetic declination.

```
magneticDeclinationOfBoston = -e(1)
```

```
magneticDeclinationOfBoston = -14.6563
```

Return Rotation Matrix

The `ecompass` function fuses magnetometer and accelerometer data to return a quaternion that, when used within a quaternion rotation operator, can rotate quantities from a parent (NED) frame to a child frame. The `ecompass` function can also return rotation matrices that perform equivalent rotations as the quaternion operator.

Define a rotation that can take a parent frame pointing to magnetic north to a child frame pointing to geographic north. Define the rotation as both a quaternion and a rotation matrix. Then, convert the quaternion and rotation matrix to Euler angles in degrees for comparison.

Define the magnetic field strength in microteslas in Boston, MA, when pointed true north.

```
m = [19.535 -5.109 47.930];  
a = [0 0 9.8];
```

Determine the quaternion and rotation matrix that is capable of rotating a frame from magnetic north to true north. Display the results for comparison.

```
q = ecompass(a,m);  
quaternionEulerAngles = eulerd(q, 'ZYX', 'frame')
```

```
quaternionEulerAngles = 1×3  
    14.6563         0         0
```

```
r = ecompass(a,m, 'rotmat');  
theta = -asin(r(1,3));  
psi = atan2(r(2,3)/cos(theta), r(3,3)/cos(theta));  
rho = atan2(r(1,2)/cos(theta), r(1,1)/cos(theta));  
rotmatEulerAngles = rad2deg([rho,theta,psi])
```

```
rotmatEulerAngles = 1×3  
    14.6563         0         0
```

Determine Gravity Vector

Use `ecompass` to determine the gravity vector based on data from a rotating IMU.

Load the inertial measurement unit (IMU) data.

```
load 'rpy_9axis.mat' sensorData Fs
```

Determine the orientation of the sensor body relative to the local NED frame over time.

```
orientation = ecompass(sensorData.Acceleration, sensorData.MagneticField);
```

To estimate the gravity vector, first rotate the accelerometer readings from the sensor body frame to the NED frame using the `orientation` quaternion vector.

```
gravityVectors = rotatepoint(orientation,sensorData.Acceleration);
```

Determine the gravity vector as an average of the recovered gravity vectors over time.

```
gravityVectorEstimate = mean(gravityVectors,1)
```

```
gravityVectorEstimate = 1x3
```

```
    0.0000    -0.0000    10.2102
```

Track Spinning Platform

Fuse modeled accelerometer and gyroscope data to track a spinning platform using both idealized and realistic data.

Generate Ground-Truth Trajectory

Describe the ground-truth orientation of the platform over time. Use the `kinematicTrajectory` on page 3-202 System object™ to create a trajectory for a platform that has no translation and spins about its z-axis.

```
duration = 12;
```

```
fs = 100;
```

```
numSamples = fs*duration;
```

```
accelerationBody = zeros(numSamples,3);
```

```
angularVelocityBody = zeros(numSamples,3);
```

```
zAxisAngularVelocity = [linspace(0,4*pi,4*fs),4*pi*ones(1,4*fs),linspace(4*pi,0,4*fs)'];
```

```
angularVelocityBody(:,3) = zAxisAngularVelocity;
```

```
trajectory = kinematicTrajectory('SampleRate',fs);
```

```
[~,orientationNED,~,accelerationNED,angularVelocityNED] = trajectory(accelerationBody,angularVelocityBody);
```

Model Receiving IMU Data

Use an `imuSensor` on page 3-581 System object to mimic data received from an IMU that contains an ideal magnetometer and an ideal accelerometer.

```
IMU = imuSensor('accel-mag','SampleRate',fs);
```

```
[accelerometerData,magnetometerData] = IMU(accelerationNED, ...
                                             angularVelocityNED, ...
                                             orientationNED);
```

Fuse IMU Data to Estimate Orientation

Pass the accelerometer data and magnetometer data to the `ecompass` function to estimate orientation over time. Convert the orientation to Euler angles in degrees and plot the result.

```
orientation = ecompass(accelerometerData,magnetometerData);
```

```
orientationEuler = eulerd(orientation,'ZYX','frame');
```

```
timeVector = (0:numSamples-1).'/fs;
```

```

figure(1)
plot(timeVector,orientationEuler)
legend('z-axis','y-axis','x-axis')
xlabel('Time (s)')
ylabel('Rotation (degrees)')
title('Orientation from Ideal IMU')

```

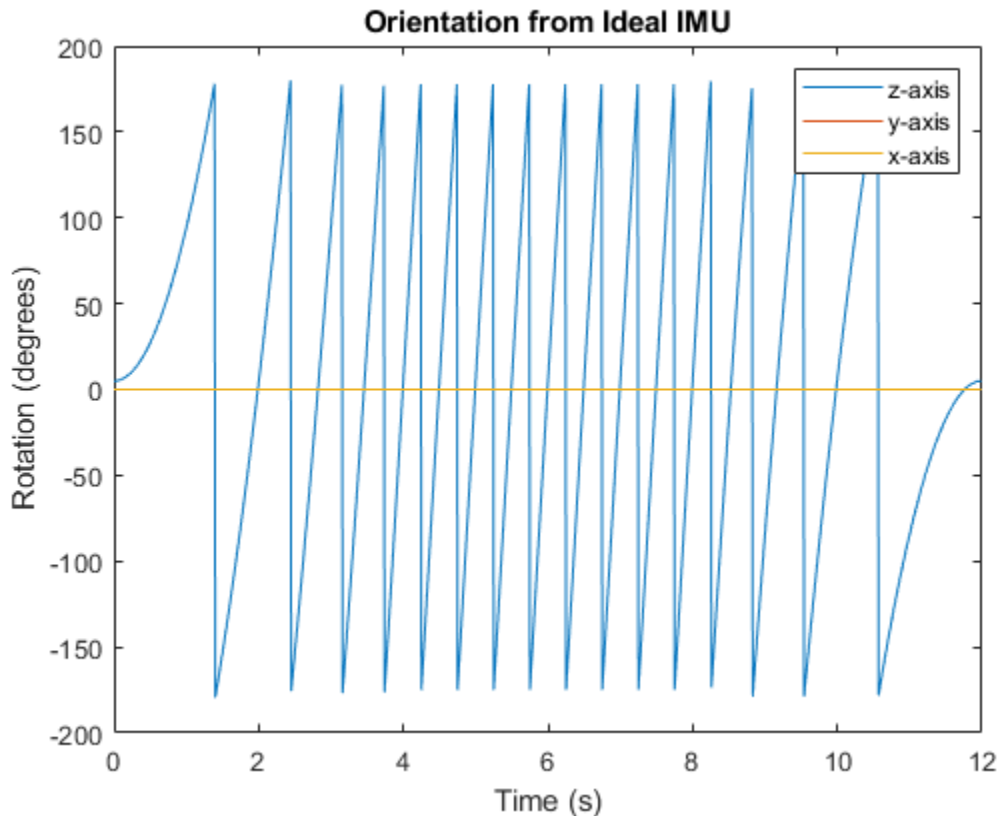

Repeat Experiment with Realistic IMU Sensor Model

Modify parameters of the IMU System object to approximate realistic IMU sensor data. Reset the IMU and then call it with the same ground-truth acceleration, angular velocity, and orientation. Use `ecompass` to fuse the IMU data and plot the results.

```

IMU.Accelerometer = accelparams( ...
    'MeasurementRange',20, ...
    'Resolution',0.0006, ...
    'ConstantBias',0.5, ...
    'AxesMisalignment',2, ...
    'NoiseDensity',0.004, ...
    'BiasInstability',0.5);
IMU.Magnetometer = magparams( ...
    'MeasurementRange',200, ...
    'Resolution',0.01);
reset(IMU)

[accelerometerData,magnetometerData] = IMU(accelerationNED,angularVelocityNED,orientationNED);

```

```
orientation = ecompass(accelerometerData,magnetometerData);
orientationEuler = eulder(orientation,'ZYX','frame');
```

```
figure(2)
plot(timeVector,orientationEuler)
legend('z-axis','y-axis','x-axis')
xlabel('Time (s)')
ylabel('Rotation (degrees)')
title('Orientation from Realistic IMU')
```

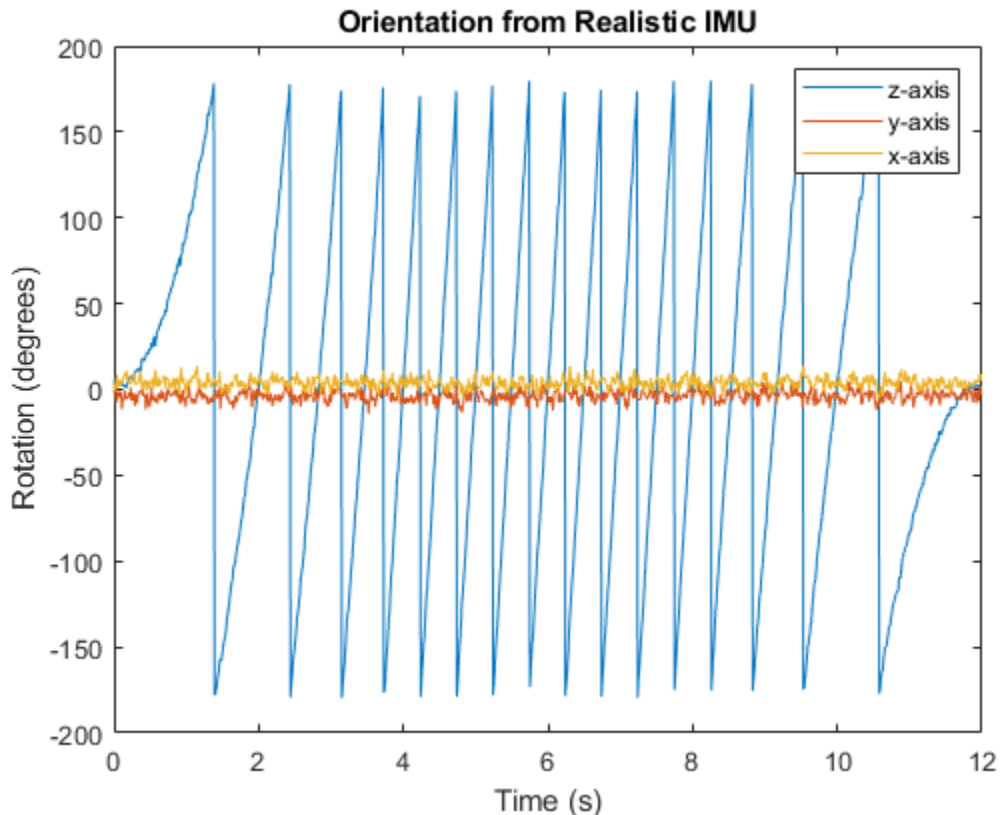

Input Arguments

accelerometerReading — Accelerometer readings in sensor body coordinate system (m/s²)

N-by-3 matrix

Accelerometer readings in sensor body coordinate system in m/s², specified as an *N*-by-3 matrix. The columns of the matrix correspond to the *x*-, *y*-, and *z*-axes of the sensor body. The rows in the matrix, *N*, correspond to individual samples. The accelerometer readings are normalized before use in the function.

Data Types: single | double

magnetometerReading — Magnetometer readings in sensor body coordinate system (μT)

N-by-3 matrix

Magnetometer readings in sensor body coordinate system in μT, specified as an *N*-by-3 matrix. The columns of the matrix correspond to the *x*-, *y*-, and *z*-axes of the sensor body. The rows in the matrix,

N , correspond to individual samples. The magnetometer readings are normalized before use in the function.

Data Types: `single` | `double`

orientationFormat — Format used to describe orientation

'quaternion' (default) | 'rotmat'

Format used to describe orientation, specified as 'quaternion' or 'rotmat'.

Data Types: `char` | `string`

Output Arguments

orientation — Orientation that rotates quantities from global coordinate system to sensor body coordinate system

N -by-1 vector of quaternions (default) | 3-by-3-by- N array

Orientation that can rotate quantities from a global coordinate system to a body coordinate system, returned as a vector of quaternions or an array. The size and type of the `orientation` depends on the format used to describe orientation:

- 'quaternion' -- N -by-1 vector of quaternions with the same underlying data type as the input
- 'rotmat' -- 3-by-3-by- N array the same data type as the input

Data Types: `quaternion` | `single` | `double`

Algorithms

The `ecompass` function returns a quaternion or rotation matrix that can rotate quantities from a parent (NED for example) frame to a child (sensor) frame. For both output orientation formats, the rotation operator is determined by computing the rotation matrix.

The rotation matrix is first calculated with an intermediary:

$$R = \begin{bmatrix} (a \times m) \times a & a \times m & a \end{bmatrix}$$

and then normalized column-wise. a and m are the `accelerometerReading` input and the `magnetometerReading` input, respectively.

To understand the rotation matrix calculation, consider an arbitrary point on the Earth and its corresponding local NED frame. Assume a sensor body frame, $[x,y,z]$, with the same origin.

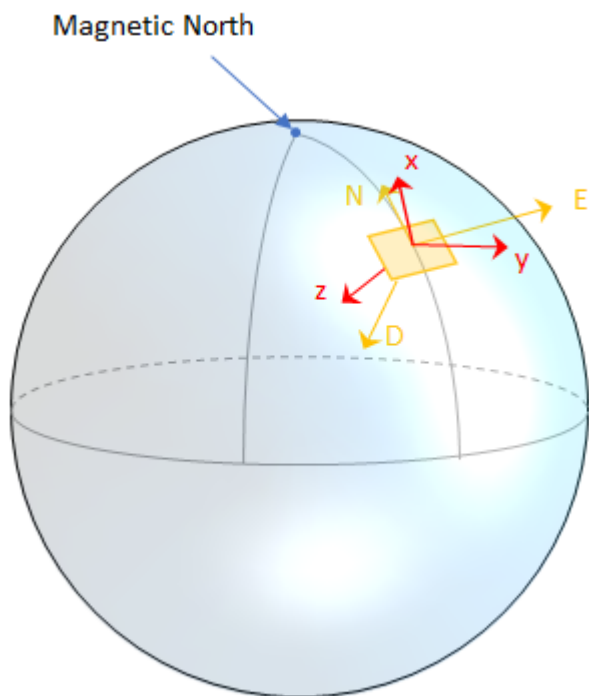

Recall that orientation of a sensor body is defined as the rotation operator (rotation matrix or quaternion) required to rotate a quantity from a parent (NED) frame to a child (sensor body) frame:

$$\begin{bmatrix} R \end{bmatrix} \begin{bmatrix} p_{\text{parent}} \end{bmatrix} = \begin{bmatrix} p_{\text{child}} \end{bmatrix}$$

where

- R is a 3-by-3 rotation matrix, which can be interpreted as the orientation of the child frame.
- p_{parent} is a 3-by-1 vector in the parent frame.
- p_{child} is a 3-by-1 vector in the child frame.

For a stable sensor body, an accelerometer returns the acceleration due to gravity. If the sensor body is perfectly aligned with the NED coordinate system, all acceleration due to gravity is along the z -axis, and the accelerometer reads $[0 \ 0 \ 1]$. Consider the rotation matrix required to rotate a quantity from the NED coordinate system to a quantity indicated by the accelerometer.

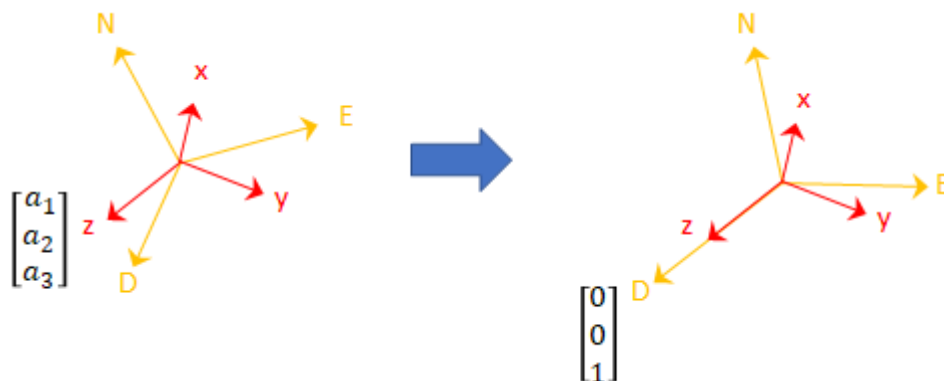

$$\begin{bmatrix} r_{11} & r_{21} & r_{31} \\ r_{12} & r_{22} & r_{32} \\ r_{13} & r_{23} & r_{33} \end{bmatrix} \begin{bmatrix} 0 \\ 0 \\ 1 \end{bmatrix} = \begin{bmatrix} a_1 \\ a_2 \\ a_3 \end{bmatrix}$$

The third column of the rotation matrix corresponds to the accelerometer reading:

$$\begin{bmatrix} r_{31} \\ r_{32} \\ r_{33} \end{bmatrix} = \begin{bmatrix} a_1 \\ a_2 \\ a_3 \end{bmatrix}$$

A magnetometer reading points toward magnetic north and is in the N - D plane. Again, consider a sensor body frame aligned with the NED coordinate system.

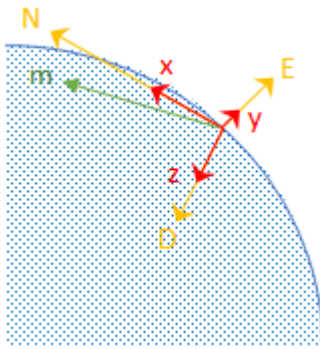

By definition, the E -axis is perpendicular to the N - D plane, therefore $N \times D = E$, within some amplitude scaling. If the sensor body frame is aligned with NED, both the acceleration vector from the accelerometer and the magnetic field vector from the magnetometer lie in the N - D plane. Therefore $m \times a = y$, again with some amplitude scaling.

Consider the rotation matrix required to rotate NED to the child frame, $[x \ y \ z]$.

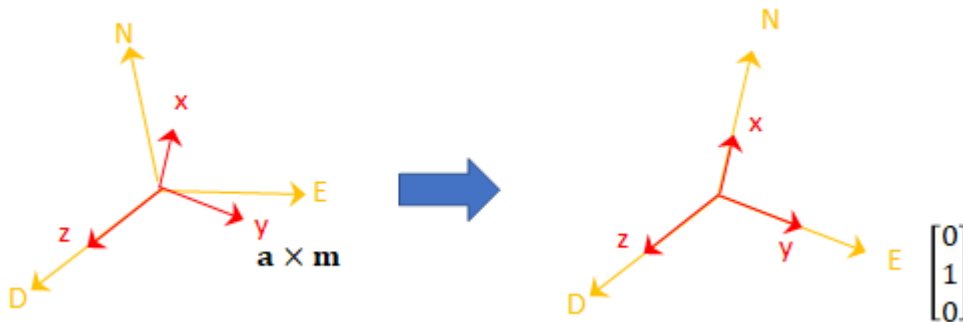

$$\begin{bmatrix} r_{11} & r_{21} & r_{31} \\ r_{12} & r_{22} & r_{32} \\ r_{13} & r_{23} & r_{33} \end{bmatrix} \begin{bmatrix} 0 \\ 1 \\ 0 \end{bmatrix} = \begin{bmatrix} a_1 \\ a_2 \\ a_3 \end{bmatrix} \times \begin{bmatrix} m_1 \\ m_2 \\ m_3 \end{bmatrix}$$

The second column of the rotation matrix corresponds to the cross product of the accelerometer reading and the magnetometer reading:

$$\begin{bmatrix} r_{21} \\ r_{22} \\ r_{23} \end{bmatrix} = \begin{bmatrix} a_1 \\ a_2 \\ a_3 \end{bmatrix} \times \begin{bmatrix} m_1 \\ m_2 \\ m_3 \end{bmatrix}$$

By definition of a rotation matrix, column 1 is the cross product of columns 2 and 3:

$$\begin{bmatrix} r_{11} \\ r_{12} \\ r_{13} \end{bmatrix} = \begin{bmatrix} r_{21} \\ r_{22} \\ r_{23} \end{bmatrix} \times \begin{bmatrix} r_{31} \\ r_{32} \\ r_{33} \end{bmatrix} \\ = (a \times m) \times a$$

Finally, the rotation matrix is normalized column-wise:

$$R_{ij} = \frac{R_{ij}}{\sqrt{\sum_{i=1}^3 R_{ij}^2}}, \forall j$$

Note The ecompass algorithm uses magnetic north, not true north, for the NED coordinate system.

References

[1] Open Source Sensor Fusion. <https://github.com/memsindustrygroup/Open-Source-Sensor-Fusion/tree/master/docs>

Extended Capabilities

C/C++ Code Generation

Generate C and C++ code using MATLAB® Coder™.

See Also

`ahrsfilter` | `imufilter` | `quaternion`

Topics

“Determine Orientation Using Inertial Sensors”

Introduced in R2018b

magcal

Magnetometer calibration coefficients

Syntax

```
[A,b,expmfs] = magcal(D)
[A,b,expmfs] = magcal(D,fitkind)
```

Description

`[A,b,expmfs] = magcal(D)` returns the coefficients needed to correct uncalibrated magnetometer data `D`.

To produce the calibrated magnetometer data `C`, use equation $C = (D-b)*A$. The calibrated data `C` lies on a sphere of radius `expmfs`.

`[A,b,expmfs] = magcal(D,fitkind)` constrains the matrix `A` to be the type specified by `fitkind`. Use this syntax when only the soft- or hard-iron effect needs to be corrected.

Examples

Correct Data Lying on Ellipsoid

Generate uncalibrated magnetometer data lying on an ellipsoid.

```
c = [-50; 20; 100]; % ellipsoid center
r = [30; 20; 50]; % semiaxis radii

[x,y,z] = ellipsoid(c(1),c(2),c(3),r(1),r(2),r(3),20);
D = [x(:),y(:),z(:)];
```

Correct the magnetometer data so that it lies on a sphere. The option for the calibration is set by default to 'auto'.

```
[A,b,expmfs] = magcal(D); % calibration coefficients
expmfs % Dipaly expected magnetic field strength in uT

expmfs = 31.0723

C = (D-b)*A; % calibrated data
```

Visualize the uncalibrated and calibrated magnetometer data.

```
figure(1)
plot3(x(:),y(:),z(:),'LineStyle','none','Marker','X','MarkerSize',8)
hold on
grid(gca,'on')
plot3(C(:,1),C(:,2),C(:,3),'LineStyle','none','Marker', ...
      'o','MarkerSize',8,'MarkerFaceColor','r')
axis equal
xlabel('uT')
```

```

ylabel('uT')
zlabel('uT')
legend('Uncalibrated Samples', 'Calibrated Samples','Location', 'southoutside')
title("Uncalibrated vs Calibrated" + newline + "Magnetometer Measurements")
hold off

```

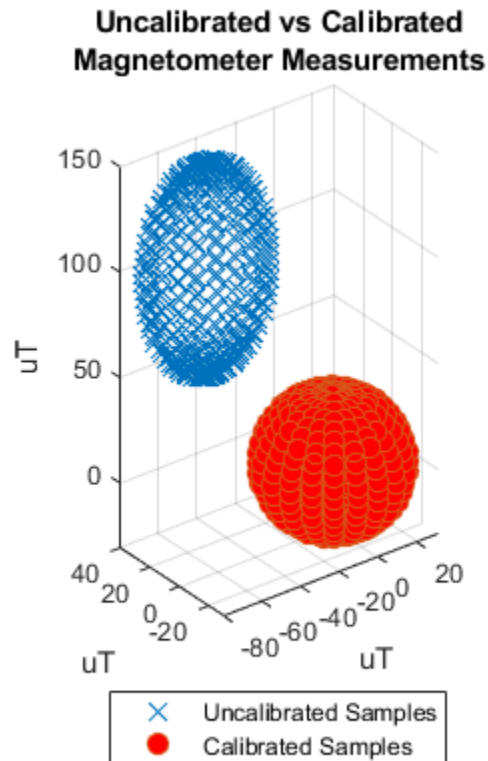

Input Arguments

D — Raw magnetometer data

N-by-3 matrix (default)

Input matrix of raw magnetometer data, specified as a *N*-by-3 matrix. Each column of the matrix corresponds to the magnetometer measurements in the first, second and third axes, respectively. Each row of the matrix corresponds to a single three-axis measurement.

Data Types: `single` | `double`

fitkind — Matrix output type

'auto' (default) | 'eye' | 'diag' | 'sym'

Matrix type for output A. The matrix type of A can be constrained to:

- 'eye' - identity matrix
- 'diag' - diagonal

- 'sym' - symmetric
- 'auto' - whichever of the previous options gives the best fit

Output Arguments

A — Correction matrix for soft-iron effect

3-by-3 matrix

Correction matrix for the soft-iron effect, returned as a 3-by-3 matrix.

b — Correction vector for hard-iron effect

3-by-1 vector

Correction vector for the hard-iron effect, returned as a 3-by-1 array.

expmfs — Expected magnetic field strength

scalar

Expected magnetic field strength, returned as a scalar.

More About

Soft- and Hard-Iron Effects

Because a magnetometer usually rotates through a full range of 3-D rotation, the ideal measurements from a magnetometer should form a perfect sphere centered at the origin if the magnetic field is unperturbed. However, due to distorting magnetic fields from the sensor circuit board and the surrounding environment, the spherical magnetic measurements can be perturbed. In general, two effects exist.

- 1 The soft-iron effect is described as the distortion of the ellipsoid from a sphere and the tilt of the ellipsoid, as shown in the left figure. This effect is caused by disturbances that influence the magnetic field but may not generate their own magnetic field. For example, metals such as nickel and iron can cause this kind of distortion.
- 2 The hard-iron effect is described as the offset of the ellipsoid center from the origin. This effect is produced by materials that exhibit a constant, additive field to the earth's magnetic field. This constant additive offset is in addition to the soft-iron effect as shown in the figure on the right.

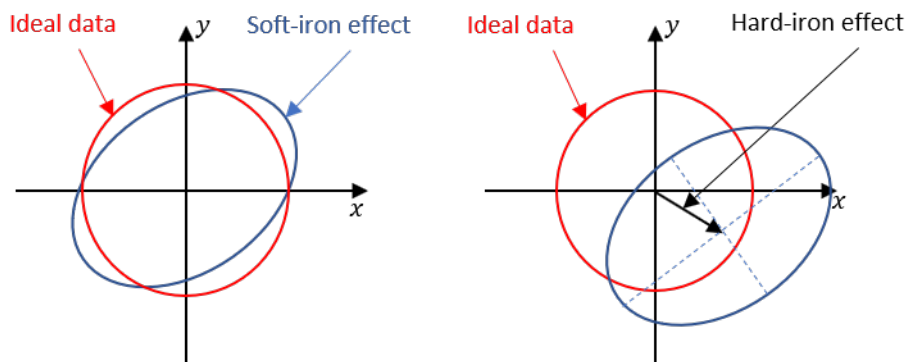

The underlying algorithm in `magcal` determines the best-fit ellipsoid to the raw sensor readings and attempts to "invert" the ellipsoid to produce a sphere. The goal is to generate a correction matrix **A** to

account for the soft-iron effect and a vector \mathbf{b} to account for the hard-iron effect. The three output options, 'eye', 'diag' and 'sym' correspond to three parameter-solving algorithms, and the 'auto' option chooses among these three options to give the best fit.

References

- [1] Ozyagcilar, T. "Calibrating an eCompass in the Presence of Hard and Soft-iron Interference."
Freescale Semiconductor Ltd. 1992, pp. 1-17.

See Also

Classes

magparams

Objects

imuSensor

Introduced in R2019a

monteCarloRun

Monte Carlo realization of tracking scenario

Syntax

```
recordings = monteCarloRun(scenario,numRuns)
recordings = monteCarloRun(scenario,numRuns,Name,Value)
[recordings,rngs] = monteCarloRun( ___ )
```

Description

`recordings = monteCarloRun(scenario,numRuns)` runs a tracking scenario multiple times and saves the running recording of every run. Each run, called a realization of the scenario, is with a different random seed.

`recordings = monteCarloRun(scenario,numRuns,Name,Value)` specifies options using one or more name-value pair arguments. Enclose each `Name` in quotes.

`[recordings,rngs] = monteCarloRun(___)` also returns the random number generator values at the beginning of each realization run.

Examples

Run Scenario Twice with Automatic Random Seeds

Load a prerecorded tracking scenario.

```
load ATCSscenario.mat scenario
```

Execute two Monte Carlo runs and display the running time. The actual running time will depend on the computation ability of your machine.

```
tic
recordings = monteCarloRun(scenario,2);
disp("Time to run the scenarios: " + toc + " sec")
```

```
Time to run the scenarios: 153.2316 sec
```

Run the Monte Carlo simulations again using parallel computing.

```
tic
recordings = monteCarloRun(scenario,2,'UseParallel',true);
```

```
Starting parallel pool (parpool) using the 'local' profile ...
Connected to the parallel pool (number of workers: 6).
```

```
disp("Time to run the scenarios in parallel: " + toc + " sec")
```

```
Time to run the scenarios in parallel: 118.1509 sec
```

Input Arguments

scenario — Tracking scenario

M-element array of `trackingScenario` objects | *M*-element cell array of `trackingScenario` objects

Tracking scenario, specified as an *M*-element array of `trackingScenario` objects or an *M*-element cell array of `trackingScenario` objects.

numRuns — Number of Monte Carlo runs

positive integer

Numbers of Monte Carlo runs, specified as a positive integer.

Name-Value Pair Arguments

Specify optional comma-separated pairs of `Name`, `Value` arguments. `Name` is the argument name and `Value` is the corresponding value. `Name` must appear inside quotes. You can specify several name and value pair arguments in any order as `Name1`, `Value1`, ..., `NameN`, `ValueN`.

Example: `monteCarloRun(sc,3,'UseParallel',false)`

UseParallel — Enable parallel computing

`false` (default) | `true`

Enable parallel computing, specified as `true` or `false`. Using parallel computing requires a Parallel Computing Toolbox™ license and an open parallel pool.

InitialSeeds — Initial random seeds

integer in $[0, 2^{32} - 1]$ | `numRuns`-element array of integers in $[0, 2^{32} - 1]$

Initial random seeds for obtaining repeatable results, specified as an integer in $[0, 2^{32} - 1]$ or an array of integers in $[0, 2^{32} - 1]$. If specified as an integer, an array of seed values is randomly generated using the integer as an initial seed. If unspecified, the function uses the current random number generator to randomly generate an array of initial seeds.

Output Arguments

recordings — Monte Carlo recordings of tracking scenario

M-by-`numRuns` array of `trackingScenarioRecording` objects

Monte Carlo recordings of a tracking scenario, returned as a *M*-by-`numRuns` array of `trackingScenarioRecording` objects.

rngs — Random number generator values

M-by-`numRuns` array of structures

Random number generator values, returned as a *M*-by-`numRuns` array of structures. The fields of each structure are the same as the output of the `rng` function.

See Also

`rng` | `trackingScenario` | `trackingScenarioRecording`

Introduced in R2020a

partitionDetections

Partition detections based on Mahalanobis distance

Syntax

```
partitions = partitionDetections(detections)
partitions = partitionDetections(detections,tLower,tUpper)
partitions = partitionDetections(detections,tLower,tUpper,'MaxNumPartitions',
maxNumber)
partitions = partitionDetections(detections,allThresholds)
```

Description

Using multiple distance thresholds, the function separates detections into different detection cells based on their relative Mahalanobis distances and reports all the possible partitions. A partition of a set of detections is defined as a division of these detections into nonempty mutually exclusive detection cells. A detection cell is a group of detections whose distance to at least one other detection in the cell is less than the distance threshold. In other words, two detections belong to the same detection cell if their distance is less than the distance threshold.

`partitions = partitionDetections(detections)` returns possible partitions from `detections`, using distance partitioning algorithm. By default, the function considers all real value Mahalanobis distance thresholds between 0.5 and 6.25.

`partitions = partitionDetections(detections,tLower,tUpper)` allows you to specify the lower and upper bounds of the distance thresholds, `tLower` and `tUpper`.

`partitions = partitionDetections(detections,tLower,tUpper,'MaxNumPartitions',maxNumber)` allows you to specify the maximum number of allowed partitions, `maxNumber`, in addition to the lower and upper bounds of the distance thresholds, `tLower` and `tUpper`.

`partitions = partitionDetections(detections,allThresholds)` allows you to specify the exact thresholds considered for partition.

Examples

Generate Partition from Object Detection

Generate 2-D detections using `objectDetection`.

```
rng(2018); % For reproducible results
detections = cell(10,1);
for i = 1:numel(detections)
    id = randi([1 5]);
    detections{i} = objectDetection(0,[id;id] + 0.1*randn(2,1));
    detections{i}.MeasurementNoise = 0.01*eye(2);
end
```

Extract and display generated position measurements.

```

d = [detections{:}];
measurements = [d.Measurement];

figure()
plot(measurements(1,:),measurements(2:,:), 'x', 'MarkerSize',10, 'MarkerEdgeColor', 'b')
title('Measurements')
xlabel('x')
ylabel('y')

```

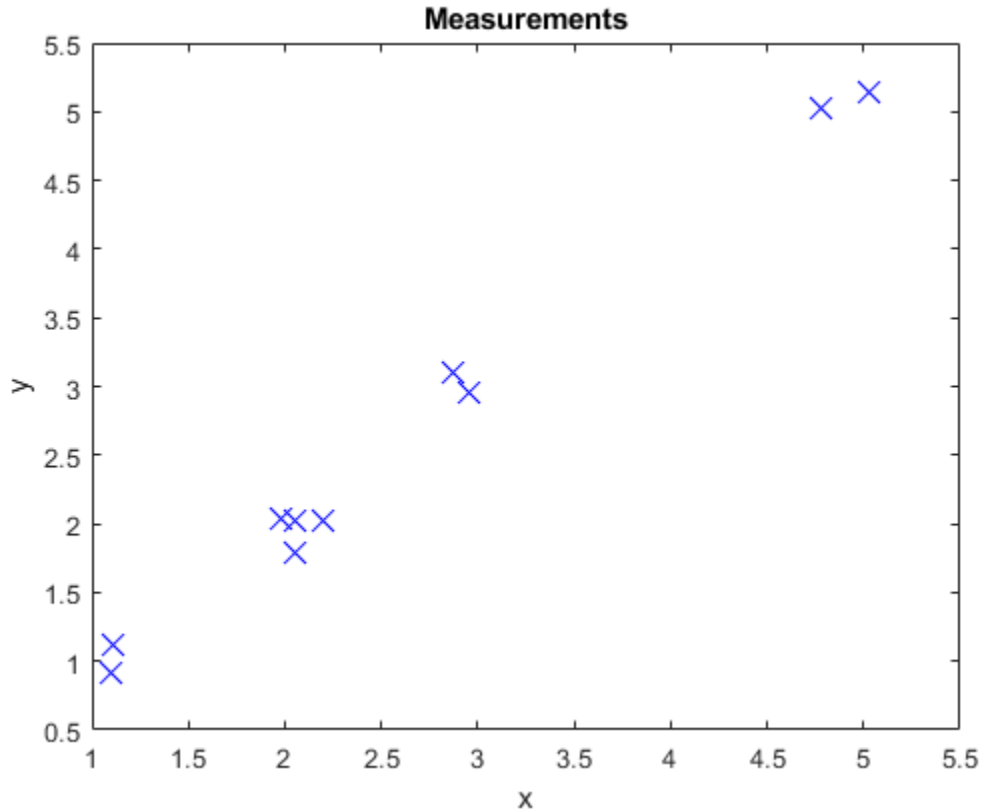

Generate partitions from the detections and count the number of partitions.

```

partitions = partitionDetections(detections);
numPartitions = size(partitions,2);

```

Visualize the partitions. Each color represents a detection cell.

```

figure()
for i = 1:numPartitions
    numCells = max(partitions(:,i));
    subplot(3,ceil(numPartitions/3),i);
    for k = 1:numCells
        ids = partitions(:,i) == k;
        plot(measurements(1,ids),measurements(2,ids),'.','MarkerSize',15);
        hold on;
    end
    title(['Partition ',num2str(i),' (' ,num2str(k),' Detection cells)']);
end
end

```

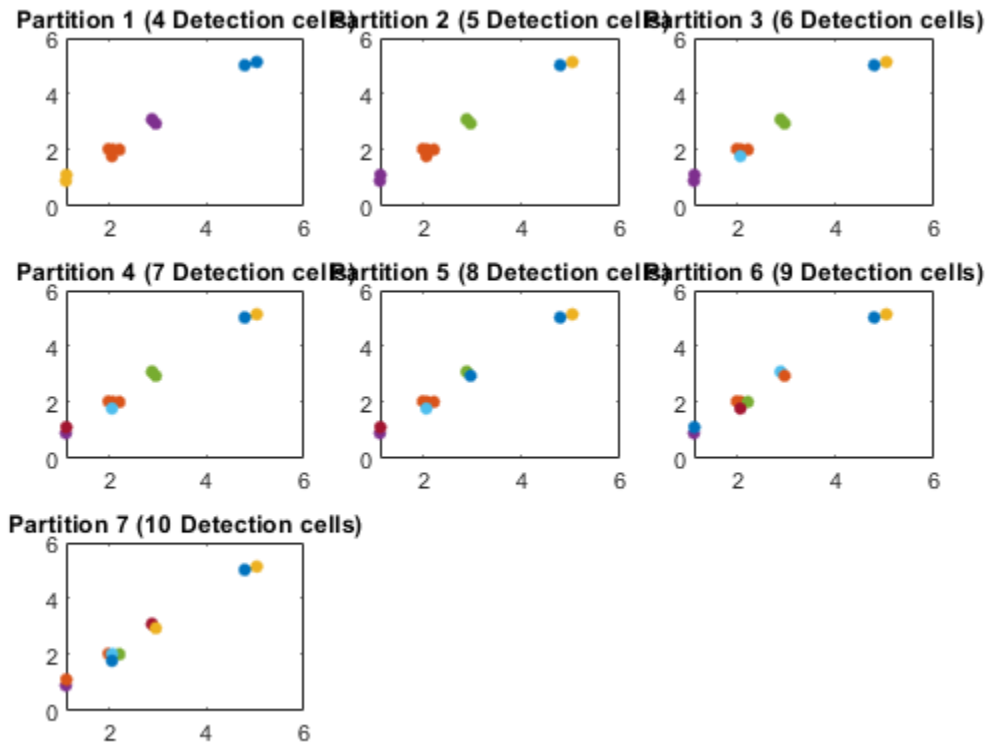

Input Arguments

detections — Object detections

N-element cell array

Object detections, specified as an *N*-element cell array of `objectDetection` objects, where *N* is the number of detections. You can create detections directly, or you can obtain detections from the outputs of sensor objects, such as `fusionRadarSensor`, `irSensor`, and `sonarSensor`.

Data Types: `cell`

tLower — Lower bound of distance thresholds

scalar

Lower bound of distance thresholds, specified as a scalar. This argument sets the lower bound of the Mahalanobis distance thresholds considered for partition.

Example: `0.05`

Data Types: `double`

tUpper — Upper bound of distance thresholds

scalar

Upper bound of distance thresholds, specified as a scalar. This argument sets the upper bound of the Mahalanobis distance thresholds considered for partition.

Example: 0.98

Data Types: double

maxNumber — Maximum number of allowed partitions

positive integer

Maximum number of allowed partitions, specified as a positive integer.

Example: 20

Data Types: double

allThresholds — All thresholds for partitions

M -element vector

All thresholds for partitions, specified as an M element vector. The function calculates partitions based on each threshold value provided in `allThresholds`. Note that multiple thresholds can result in the same partition, and the function output `partitions`, given as an N -by- Q matrix with $Q \leq M$, only contains unique partitions.

Example: [0.1;0.2;0.35;0.4]

Data Types: double

Output Arguments

partitions — Partitions of detections

N -by- Q matrix

Partitions of detections, specified as an N -by- Q matrix. N is the number of detections, and Q is the number of partitions. Each column of the matrix represents a valid partition. In each column, the value of the i th element represents the identity number of the detection cell that the i th detection belongs to. For example, given a partition matrix P , if $P(i,j) = k$, then in partition j , detection i belongs to detection cell k .

References

- [1] Granstorm, K., C. Lundquist, and O. Orguner. "Extended target tracking using a Gaussian-mixture PHD filter." *IEEE Transactions on Aerospace and Electronic Systems*. Vol. 48, Number 4, 2012, pp. 3268–3286.

Extended Capabilities

C/C++ Code Generation

Generate C and C++ code using MATLAB® Coder™.

Usage notes and limitations:

- The code generation configuration must allow recursion.

See Also

`objectDetection` | `trackerPHD`

Introduced in R2019a

randrot

Uniformly distributed random rotations

Syntax

```
R = randrot
R = randrot(m)
R = randrot(m1,...,mN)
R = randrot([m1,...,mN])
```

Description

`R = randrot` returns a unit quaternion drawn from a uniform distribution of random rotations.

`R = randrot(m)` returns an m -by- m matrix of unit quaternions drawn from a uniform distribution of random rotations.

`R = randrot(m1,...,mN)` returns an $m1$ -by-...-by- mN array of random unit quaternions, where $m1, \dots, mN$ indicate the size of each dimension. For example, `randrot(3,4)` returns a 3-by-4 matrix of random unit quaternions.

`R = randrot([m1,...,mN])` returns an $m1$ -by-...-by- mN array of random unit quaternions, where $m1, \dots, mN$ indicate the size of each dimension. For example, `randrot([3,4])` returns a 3-by-4 matrix of random unit quaternions.

Examples

Matrix of Random Rotations

Generate a 3-by-3 matrix of uniformly distributed random rotations.

```
r = randrot(3)
```

r=3x3 quaternion array

```
0.17446 + 0.59506i - 0.73295j + 0.27976k    0.69704 - 0.060589i + 0.68679j - 0.1969
0.21908 - 0.89875i - 0.298j + 0.23548k    -0.049744 + 0.59691i + 0.56459j + 0.5678
0.6375 + 0.49338i - 0.24049j + 0.54068k    0.2979 - 0.53568i + 0.31819j + 0.7232
```

Create Uniform Distribution of Random Rotations

Create a vector of 500 random quaternions. Use `rotatepoint` on page 1-139 to visualize the distribution of the random rotations applied to point (1, 0, 0).

```
q = randrot(500,1);
```

```
pt = rotatepoint(q, [1 0 0]);
```



```
figure
scatter3(pt(:,1), pt(:,2), pt(:,3))
axis equal
```

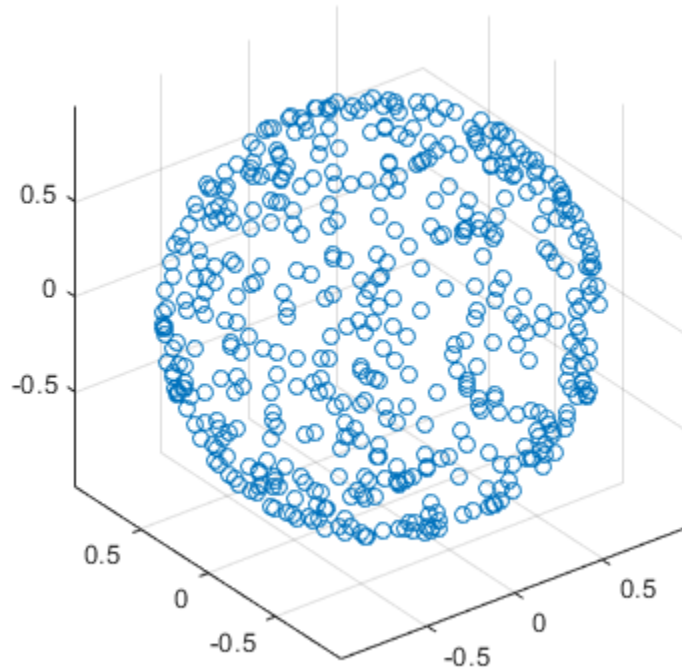

Input Arguments

m — Size of square matrix

integer

Size of square quaternion matrix, specified as an integer value. If *m* is 0 or negative, then *R* is returned as an empty matrix.

Data Types: single | double | int8 | int16 | int32 | int64 | uint8 | uint16 | uint32 | uint64

m1, ..., mN — Size of each dimension

two or more integer values

Size of each dimension, specified as two or more integer values. If the size of any dimension is 0 or negative, then *R* is returned as an empty array.

Example: `randrot(2,3)` returns a 2-by-3 matrix of random quaternions.

Data Types: single | double | int8 | int16 | int32 | int64 | uint8 | uint16 | uint32 | uint64

[m1, ..., mN] — Vector of size of each dimension

row vector of integer values

Vector of size of each dimension, specified as a row vector of two or more integer values. If the size of any dimension is 0 or negative, then **R** is returned as an empty array.

Example: `randrot([2,3])` returns a 2-by-3 matrix of random quaternions.

Data Types: `single` | `double` | `int8` | `int16` | `int32` | `int64` | `uint8` | `uint16` | `uint32` | `uint64`

Output Arguments

R — Random quaternions

`scalar` | `vector` | `matrix` | `multidimensional array`

Random quaternions, returned as a quaternion or array of quaternions.

Data Types: `quaternion`

References

[1] Shoemake, K. "Uniform Random Rotations." *Graphics Gems III* (K. David, ed.). New York: Academic Press, 1992.

Extended Capabilities

C/C++ Code Generation

Generate C and C++ code using MATLAB® Coder™.

See Also

`quaternion`

Topics

"Rotations, Orientation, and Quaternions"

Introduced in R2019a

angvel

Angular velocity from quaternion array

Syntax

```
AV = angvel(Q,dt,'frame')
AV = angvel(Q,dt,'point')
[AV,qf] = angvel(Q,dt,fp,qi)
```

Description

`AV = angvel(Q,dt,'frame')` returns the angular velocity array from an array of quaternions, `Q`. The quaternions in `Q` correspond to frame rotation. The initial quaternion is assumed to represent zero rotation.

`AV = angvel(Q,dt,'point')` returns the angular velocity array from an array of quaternions, `Q`. The quaternions in `Q` correspond to point rotation. The initial quaternion is assumed to represent zero rotation.

`[AV,qf] = angvel(Q,dt,fp,qi)` allows you to specify the initial quaternion, `qi`, and the type of rotation, `fp`. It also returns the final quaternion, `qf`.

Examples

Generate Angular Velocity From Quaternion Array

Create an array of quaternions.

```
eulerAngles = [(0:10:90).',zeros(numel(0:10:90),2)];
q = quaternion(eulerAngles,'eulerd','ZYX','frame');
```

Specify the time step and generate the angular velocity array.

```
dt = 1;
av = angvel(q,dt,'frame') % units in rad/s
```

```
av = 10x3
```

```

0         0         0
0         0     0.1743
0         0     0.1743
0         0     0.1743
0         0     0.1743
0         0     0.1743
0         0     0.1743
0         0     0.1743
0         0     0.1743
0         0     0.1743
```

Input Arguments

Q — Quaternions

N-by-1 vector of quaternions

Quaternions, specified as an *N*-by-1 vector of quaternions.

Data Types: quaternion

dt — Time step

nonnegative scalar

Time step, specified as a nonnegative scalar.

Data Types: single | double

fp — Type of rotation

'frame' | 'point'

Type of rotation, specified as 'frame' or 'point'.

qi — Initial quaternion

quaternion

Initial quaternion, specified as a quaternion.

Data Types: quaternion

Output Arguments

AV — Angular velocity

N-by-3 real matrix

Angular velocity, returned as an *N*-by-3 real matrix. *N* is the number of quaternions given in the input *Q*. Each row of the matrix corresponds to an angular velocity vector.

qf — Final quaternion

quaternion

Final quaternion, returned as a quaternion. *qf* is the same as the last quaternion in the *Q* input.

Data Types: quaternion

Extended Capabilities

C/C++ Code Generation

Generate C and C++ code using MATLAB® Coder™.

See Also

quaternion

Topics

“Rotations, Orientation, and Quaternions”

Introduced in R2020a

rotvecd

Convert quaternion to rotation vector (degrees)

Syntax

```
rotationVector = rotvecd(quat)
```

Description

`rotationVector = rotvecd(quat)` converts the quaternion array, `quat`, to an N -by-3 matrix of equivalent rotation vectors in degrees. The elements of `quat` are normalized before conversion.

Examples

Convert Quaternion to Rotation Vector in Degrees

Convert a random quaternion scalar to a rotation vector in degrees.

```
quat = quaternion(randn(1,4));  
rotvecd(quat)
```

```
ans = 1×3
```

```
    96.6345  -119.0274   45.4312
```

Input Arguments

quat — Quaternion to convert

scalar | vector | matrix | multidimensional array

Quaternion to convert, specified as scalar, vector, matrix, or multidimensional array of quaternions.

Data Types: quaternion

Output Arguments

rotationVector — Rotation vector (degrees)

N -by-3 matrix

Rotation vector representation, returned as an N -by-3 matrix of rotation vectors, where each row represents the $[x\ y\ z]$ angles of the rotation vectors in degrees. The i th row of `rotationVector` corresponds to the element `quat(i)`.

The data type of the rotation vector is the same as the underlying data type of `quat`.

Data Types: single | double

Algorithms

All rotations in 3-D can be represented by four elements: a three-element axis of rotation and a rotation angle. If the rotation axis is constrained to be unit length, the rotation angle can be distributed over the vector elements to reduce the representation to three elements.

Recall that a quaternion can be represented in axis-angle form

$$q = \cos(\theta/2) + \sin(\theta/2)(xi + yj + zk),$$

where θ is the angle of rotation in degrees, and $[x,y,z]$ represent the axis of rotation.

Given a quaternion of the form

$$q = a + bi + cj + dk,$$

you can solve for the rotation angle using the axis-angle form of quaternions:

$$\theta = 2\cos^{-1}(a).$$

Assuming a normalized axis, you can rewrite the quaternion as a rotation vector without loss of information by distributing θ over the parts b , c , and d . The rotation vector representation of q is

$$q_{rv} = \frac{\theta}{\sin(\theta/2)}[b, c, d].$$

Extended Capabilities

C/C++ Code Generation

Generate C and C++ code using MATLAB® Coder™.

See Also

Functions

euler | eulerd | rotvec

Objects

quaternion

Topics

“Rotations, Orientation, and Quaternions”

Introduced in R2018b

eulerd

Convert quaternion to Euler angles (degrees)

Syntax

```
eulerAngles = eulerd(quat, rotationSequence, rotationType)
```

Description

`eulerAngles = eulerd(quat, rotationSequence, rotationType)` converts the quaternion, `quat`, to an N -by-3 matrix of Euler angles in degrees.

Examples

Convert Quaternion to Euler Angles in Degrees

Convert a quaternion frame rotation to Euler angles in degrees using the 'ZYX' rotation sequence.

```
quat = quaternion([0.7071 0.7071 0 0]);  
eulerAnglesDegrees = eulerd(quat, 'ZYX', 'frame')
```

```
eulerAnglesDegrees = 1×3  
    0         0    90.0000
```

Input Arguments

quat — Quaternion to convert to Euler angles

scalar | vector | matrix | multidimensional array

Quaternion to convert to Euler angles, specified as a scalar, vector, matrix, or multidimensional array of quaternions.

Data Types: quaternion

rotationSequence — Rotation sequence

'ZYX' | 'YZX' | 'ZXY' | 'XZY' | 'YZY' | 'ZYX' | 'XZY' | 'YZX' | 'XYX' | 'XZY' | 'XZX'

Rotation sequence of Euler angle representation, specified as a character vector or string.

The rotation sequence defines the order of rotations about the axes. For example, if you specify a rotation sequence of 'YZX':

- 1 The first rotation is about the y-axis.
- 2 The second rotation is about the new z-axis.
- 3 The third rotation is about the new x-axis.

Data Types: char | string

rotationType — Type of rotation

'point' | 'frame'

Type of rotation, specified as 'point' or 'frame'.

In a point rotation, the frame is static and the point moves. In a frame rotation, the point is static and the frame moves. Point rotation and frame rotation define equivalent angular displacements but in opposite directions.

Point Rotation

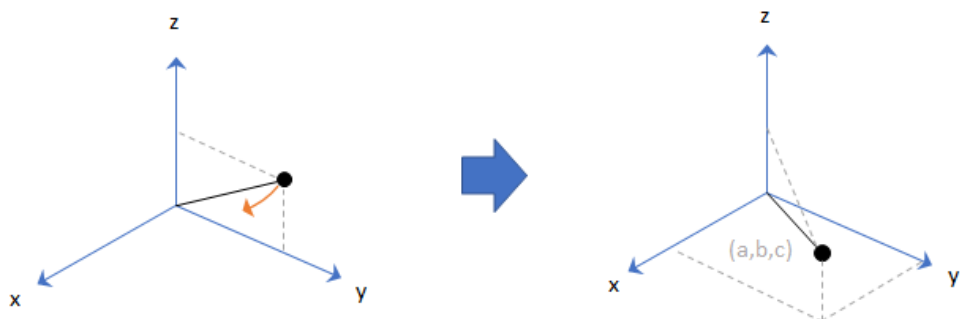

Frame Rotation

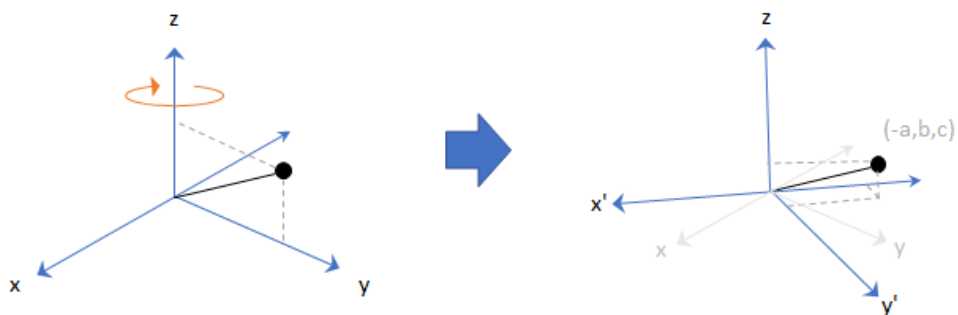

Data Types: char | string

Output Arguments**eulerAngles — Euler angle representation (degrees)** N -by-3 matrix

Euler angle representation in degrees, returned as a N -by-3 matrix. N is the number of quaternions in the `quat` argument.

For each row of `eulerAngles`, the first column corresponds to the first axis in the rotation sequence, the second column corresponds to the second axis in the rotation sequence, and the third column corresponds to the third axis in the rotation sequence.

The data type of the Euler angles representation is the same as the underlying data type of `quat`.

Data Types: single | double

Extended Capabilities

C/C++ Code Generation

Generate C and C++ code using MATLAB® Coder™.

See Also

Functions

euler | rotateframe | rotatepoint

Objects

quaternion

Topics

“Rotations, Orientation, and Quaternions”

Introduced in R2018b

meanrot

Quaternion mean rotation

Syntax

```
quatAverage = meanrot(quat)
quatAverage = meanrot(quat,dim)
quatAverage = meanrot( ___,nanflag)
```

Description

`quatAverage = meanrot(quat)` returns the average rotation of the elements of `quat` along the first array dimension whose size not does equal 1.

- If `quat` is a vector, `meanrot(quat)` returns the average rotation of the elements.
- If `quat` is a matrix, `meanrot(quat)` returns a row vector containing the average rotation of each column.
- If `quat` is a multidimensional array, then `meanrot(quat)` operates along the first array dimension whose size does not equal 1, treating the elements as vectors. This dimension becomes 1 while the sizes of all other dimensions remain the same.

The `meanrot` function normalizes the input quaternions, `quat`, before calculating the mean.

`quatAverage = meanrot(quat,dim)` return the average rotation along dimension `dim`. For example, if `quat` is a matrix, then `meanrot(quat,2)` is a column vector containing the mean of each row.

`quatAverage = meanrot(___,nanflag)` specifies whether to include or omit NaN values from the calculation for any of the previous syntaxes. `meanrot(quat,'includenan')` includes all NaN values in the calculation while `mean(quat,'omitnan')` ignores them.

Examples

Quaternion Mean Rotation

Create a matrix of quaternions corresponding to three sets of Euler angles.

```
eulerAngles = [40 20 10; ...
               50 10 5; ...
               45 70 1];
```

```
quat = quaternion(eulerAngles,'eulerd','ZYX','frame');
```

Determine the average rotation represented by the quaternions. Convert the average rotation to Euler angles in degrees for readability.

```
quatAverage = meanrot(quat)
```

```
quatAverage = quaternion
    0.88863 - 0.062598i + 0.27822j + 0.35918k

eulerAverage = eulerd(quatAverage, 'ZYX', 'frame')

eulerAverage = 1×3
    45.7876    32.6452    6.0407
```

Average Out Rotational Noise

Use `meanrot` over a sequence of quaternions to average out additive noise.

Create a vector of $1e6$ quaternions whose distance, as defined by the `dist` function, from `quaternion(1,0,0,0)` is normally distributed. Plot the Euler angles corresponding to the noisy quaternion vector.

```
nrows = 1e6;
ax = 2*rand(nrows,3) - 1;
ax = ax./sqrt(sum(ax.^2,2));
ang = 0.5*randn(size(ax,1),1);
q = quaternion(ax.*ang, 'rotvec');

noisyEulerAngles = eulerd(q, 'ZYX', 'frame');

figure(1)

subplot(3,1,1)
plot(noisyEulerAngles(:,1))
title('Z-Axis')
ylabel('Rotation (degrees)')
hold on

subplot(3,1,2)
plot(noisyEulerAngles(:,2))
title('Y-Axis')
ylabel('Rotation (degrees)')
hold on

subplot(3,1,3)
plot(noisyEulerAngles(:,3))
title('X-Axis')
ylabel('Rotation (degrees)')
hold on
```

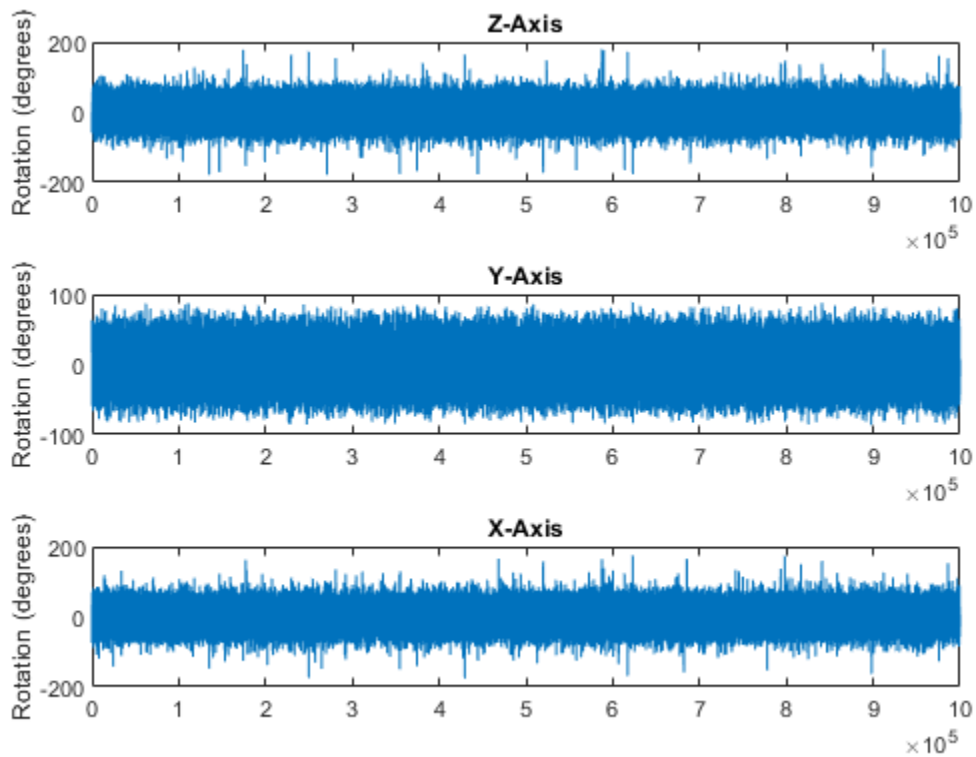

Use `meanrot` to determine the average quaternion given the vector of quaternions. Convert to Euler angles and plot the results.

```
qAverage = meanrot(q);
qAverageInEulerAngles = eulerd(qAverage, 'ZYX', 'frame');
figure(1)
subplot(3,1,1)
plot(ones(nrows,1)*qAverageInEulerAngles(:,1))
title('Z-Axis')
subplot(3,1,2)
plot(ones(nrows,1)*qAverageInEulerAngles(:,2))
title('Y-Axis')
subplot(3,1,3)
plot(ones(nrows,1)*qAverageInEulerAngles(:,3))
title('X-Axis')
```

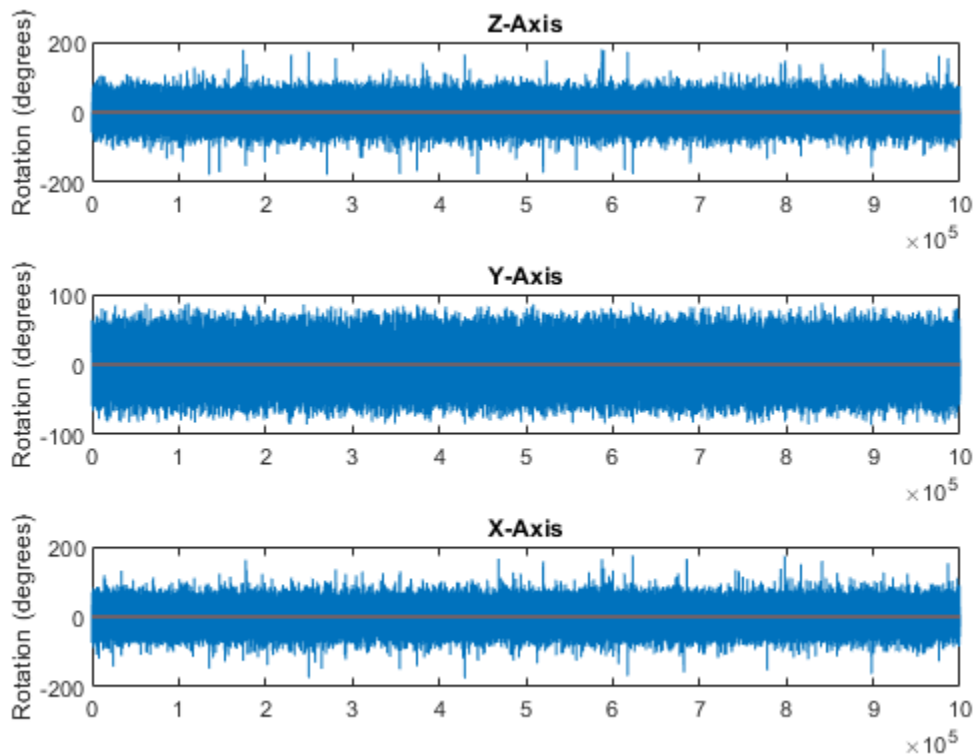

The meanrot Algorithm and Limitations

The meanrot Algorithm

The `meanrot` function outputs a quaternion that minimizes the squared Frobenius norm of the difference between rotation matrices. Consider two quaternions:

- `q0` represents no rotation.
- `q90` represents a 90 degree rotation about the x-axis.

```
q0 = quaternion([0 0 0], 'eulerd', 'ZYX', 'frame');
q90 = quaternion([0 0 90], 'eulerd', 'ZYX', 'frame');
```

Create a quaternion sweep, `qSweep`, that represents rotations from 0 to 180 degrees about the x-axis.

```
eulerSweep = (0:1:180)';
qSweep = quaternion([zeros(numel(eulerSweep),2), eulerSweep], ...
    'eulerd', 'ZYX', 'frame');
```

Convert `q0`, `q90`, and `qSweep` to rotation matrices. In a loop, calculate the metric to minimize for each member of the quaternion sweep. Plot the results and return the value of the Euler sweep that corresponds to the minimum of the metric.

```
r0 = rotmat(q0, 'frame');
r90 = rotmat(q90, 'frame');
```

```

rSweep = rotmat(qSweep, 'frame');

metricToMinimize = zeros(size(rSweep,3),1);
for i = 1:numel(qSweep)
    metricToMinimize(i) = norm((rSweep(:,:,i) - r0), 'fro').^2 + ...
        norm((rSweep(:,:,i) - r90), 'fro').^2;
end

plot(eulerSweep,metricToMinimize)
xlabel('Euler Sweep (degrees)')
ylabel('Metric to Minimize')

```

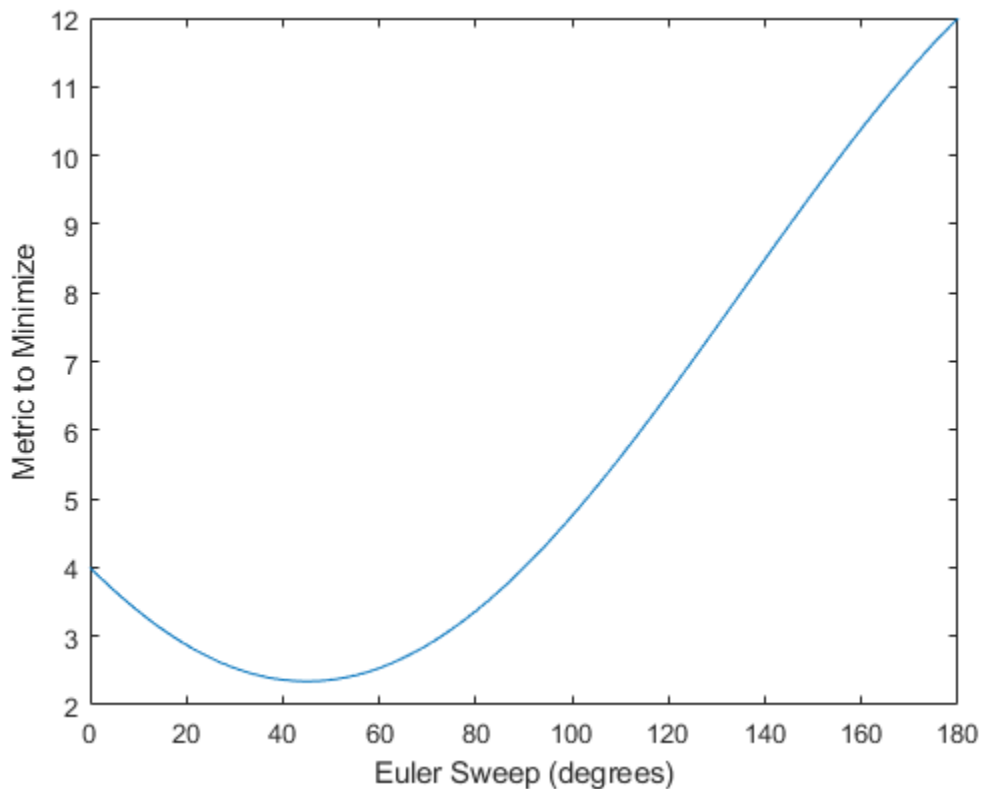

```

[~,eulerIndex] = min(metricToMinimize);
eulerSweep(eulerIndex)

```

```
ans = 45
```

The minimum of the metric corresponds to the Euler angle sweep at 45 degrees. That is, meanrot defines the average between quaternion([0 0 0], 'ZYX', 'frame') and quaternion([0 0 90], 'ZYX', 'frame') as quaternion([0 0 45], 'ZYX', 'frame'). Call meanrot with q0 and q90 to verify the same result.

```
eulerd(meanrot([q0,q90]), 'ZYX', 'frame')
```

```
ans = 1×3
```

```
0 0 45.0000
```

Limitations

The metric that `meanrot` uses to determine the mean rotation is not unique for quaternions significantly far apart. Repeat the experiment above for quaternions that are separated by 180 degrees.

```
q180 = quaternion([0 0 180], 'eulerd', 'ZYX', 'frame');
r180 = rotmat(q180, 'frame');

for i = 1:numel(qSweep)
    metricToMinimize(i) = norm((rSweep(:, :, i) - r0), 'fro').^2 + ...
        norm((rSweep(:, :, i) - r180), 'fro').^2;
end

plot(eulerSweep, metricToMinimize)
xlabel('Euler Sweep (degrees)')
ylabel('Metric to Minimize')
```

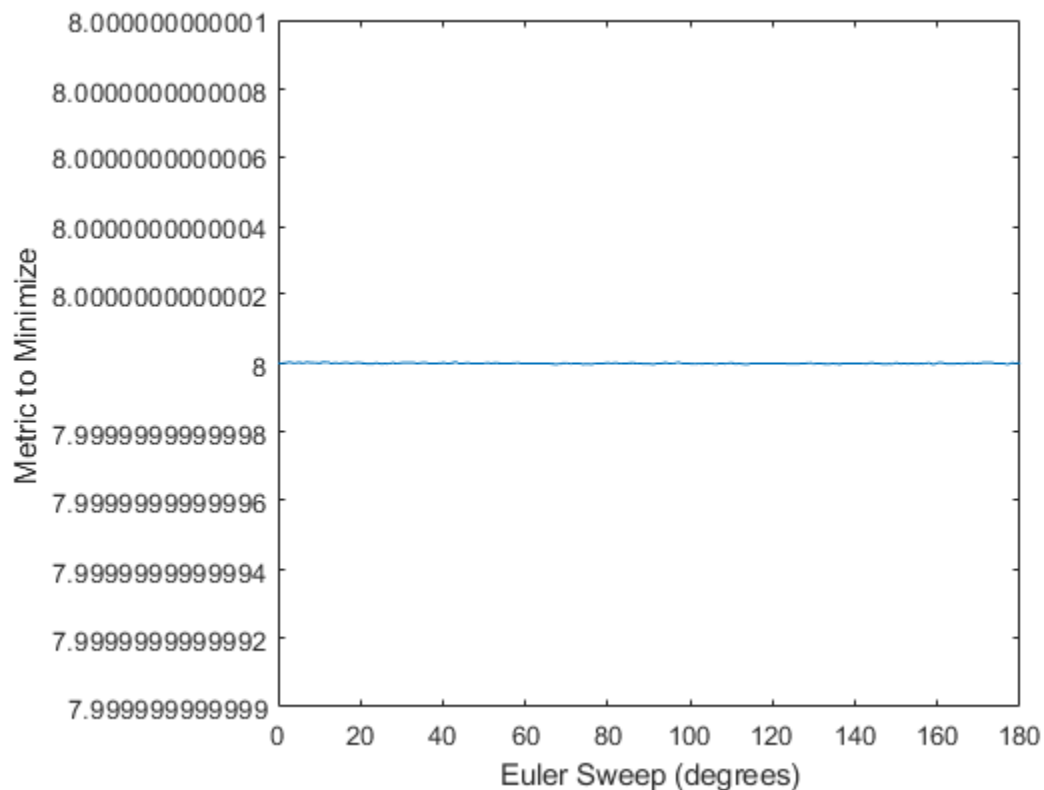

```
[~,eulerIndex] = min(metricToMinimize);
eulerSweep(eulerIndex)
```

```
ans = 159
```

Quaternion means are usually calculated for rotations that are close to each other, which makes the edge case shown in this example unlikely in real-world applications. To average two quaternions that are significantly far apart, use the `slerp` function. Repeat the experiment using `slerp` and verify that the quaternion mean returned is more intuitive for large distances.

```
qMean = slerp(q0,q180,0.5);
q0_q180 = eulerd(qMean,'ZYX','frame')

q0_q180 = 1×3
         0         0    90.0000
```

Input Arguments

quat — Quaternion

scalar | vector | matrix | multidimensional array

Quaternion for which to calculate the mean, specified as a scalar, vector, matrix, or multidimensional array of quaternions.

Data Types: quaternion

dim — Dimension to operate along

positive integer scalar

Dimension to operate along, specified as a positive integer scalar. If no value is specified, then the default is the first array dimension whose size does not equal 1.

Dimension `dim` indicates the dimension whose length reduces to 1. The `size(quatAverage,dim)` is 1, while the sizes of all other dimensions remain the same.

Data Types: double | single

nanflag — NaN condition

'includenan' (default) | 'omitnan'

NaN condition, specified as one of these values:

- 'includenan' -- Include NaN values when computing the mean rotation, resulting in NaN.
- 'omitnan' -- Ignore all NaN values in the input.

Data Types: char | string

Output Arguments

quatAverage — Quaternion average rotation

scalar | vector | matrix | multidimensional array

Quaternion average rotation, returned as a scalar, vector, matrix, or multidimensional array.

Data Types: single | double

Algorithms

meanrot determines a quaternion mean, \bar{q} , according to [1]. \bar{q} is the quaternion that minimizes the squared Frobenius norm of the difference between rotation matrices:

$$\bar{q} = \arg \min_{q \in S^3} \sum_{i=1}^n \|A(q) - A(q_i)\|_F^2$$

References

- [1] Markley, F. Landis, Yang Chen, John Lucas Crassidis, and Yaakov Oshman. "Average Quaternions." *Journal of Guidance, Control, and Dynamics*. Vol. 30, Issue 4, 2007, pp. 1193-1197.

Extended Capabilities

C/C++ Code Generation

Generate C and C++ code using MATLAB® Coder™.

See Also

Functions

dist | slerp

Objects

quaternion

Topics

"Rotations, Orientation, and Quaternions"

Introduced in R2018b

slerp

Spherical linear interpolation

Syntax

```
q0 = slerp(q1,q2,T)
```

Description

`q0 = slerp(q1,q2,T)` spherically interpolates between `q1` and `q2` by the interpolation coefficient `T`.

Examples

Interpolate Between Two Quaternions

Create two quaternions with the following interpretation:

- 1 `a` = 45 degree rotation around the z-axis
- 2 `c` = -45 degree rotation around the z-axis

```
a = quaternion([45,0,0], 'eulerd', 'ZYX', 'frame');
c = quaternion([-45,0,0], 'eulerd', 'ZYX', 'frame');
```

Call `slerp` with the quaternions `a` and `c` and specify an interpolation coefficient of 0.5.

```
interpolationCoefficient = 0.5;
b = slerp(a,c,interpolationCoefficient);
```

The output of `slerp`, `b`, represents an average rotation of `a` and `c`. To verify, convert `b` to Euler angles in degrees.

```
averageRotation = eulerd(b, 'ZYX', 'frame')
averageRotation = 1×3
```

```
    0    0    0
```

The interpolation coefficient is specified as a normalized value between 0 and 1, inclusive. An interpolation coefficient of 0 corresponds to the `a` quaternion, and an interpolation coefficient of 1 corresponds to the `c` quaternion. Call `slerp` with coefficients 0 and 1 to confirm.

```
b = slerp(a,c,[0,1]);
eulerd(b, 'ZYX', 'frame')
ans = 2×3
    45.0000    0    0
```

```
-45.0000    0    0
```

You can create smooth paths between quaternions by specifying arrays of equally spaced interpolation coefficients.

```
path = 0:0.1:1;
interpolatedQuaternions = slerp(a,c,path);
```

For quaternions that represent rotation only about a single axis, specifying interpolation coefficients as equally spaced results in quaternions equally spaced in Euler angles. Convert `interpolatedQuaternions` to Euler angles and verify that the difference between the angles in the path is constant.

```
k = eulerd(interpolatedQuaternions, 'ZYX', 'frame');
abc = abs(diff(k))
```

```
abc = 10x3
    9.0000    0    0
    9.0000    0    0
    9.0000    0    0
    9.0000    0    0
    9.0000    0    0
    9.0000    0    0
    9.0000    0    0
    9.0000    0    0
    9.0000    0    0
    9.0000    0    0
```

Alternatively, you can use the `dist` function to verify that the distance between the interpolated quaternions is consistent. The `dist` function returns angular distance in radians; convert to degrees for easy comparison.

```
def = rad2deg(dist(interpolatedQuaternions(2:end),interpolatedQuaternions(1:end-1)))
def = 1x10
    9.0000    9.0000    9.0000    9.0000    9.0000    9.0000    9.0000    9.0000    9.0000    9.0000
```

SLERP Minimizes Great Circle Path

The SLERP algorithm interpolates along a great circle path connecting two quaternions. This example shows how the SLERP algorithm minimizes the great circle path.

Define three quaternions:

- 1 q0 - quaternion indicating no rotation from the global frame
- 2 q179 - quaternion indicating a 179 degree rotation about the z-axis
- 3 q180 - quaternion indicating a 180 degree rotation about the z-axis

4 q181 - quaternion indicating a 181 degree rotation about the z-axis

```
q0 = ones(1, 'quaternion');
q179 = quaternion([179,0,0], 'eulerd', 'ZYX', 'frame');
q180 = quaternion([180,0,0], 'eulerd', 'ZYX', 'frame');
q181 = quaternion([181,0,0], 'eulerd', 'ZYX', 'frame');
```

Use `slerp` to interpolate between `q0` and the three quaternion rotations. Specify that the paths are traveled in 10 steps.

```
T = linspace(0,1,10);
q179path = slerp(q0,q179,T);
q180path = slerp(q0,q180,T);
q181path = slerp(q0,q181,T);
```

Plot each path in terms of Euler angles in degrees.

```
q179pathEuler = eulerd(q179path, 'ZYX', 'frame');
q180pathEuler = eulerd(q180path, 'ZYX', 'frame');
q181pathEuler = eulerd(q181path, 'ZYX', 'frame');

plot(T,q179pathEuler(:,1), 'bo', ...
      T,q180pathEuler(:,1), 'r*', ...
      T,q181pathEuler(:,1), 'gd');
legend('Path to 179 degrees', ...
       'Path to 180 degrees', ...
       'Path to 181 degrees')
xlabel('Interpolation Coefficient')
ylabel('Z-Axis Rotation (Degrees)')
```

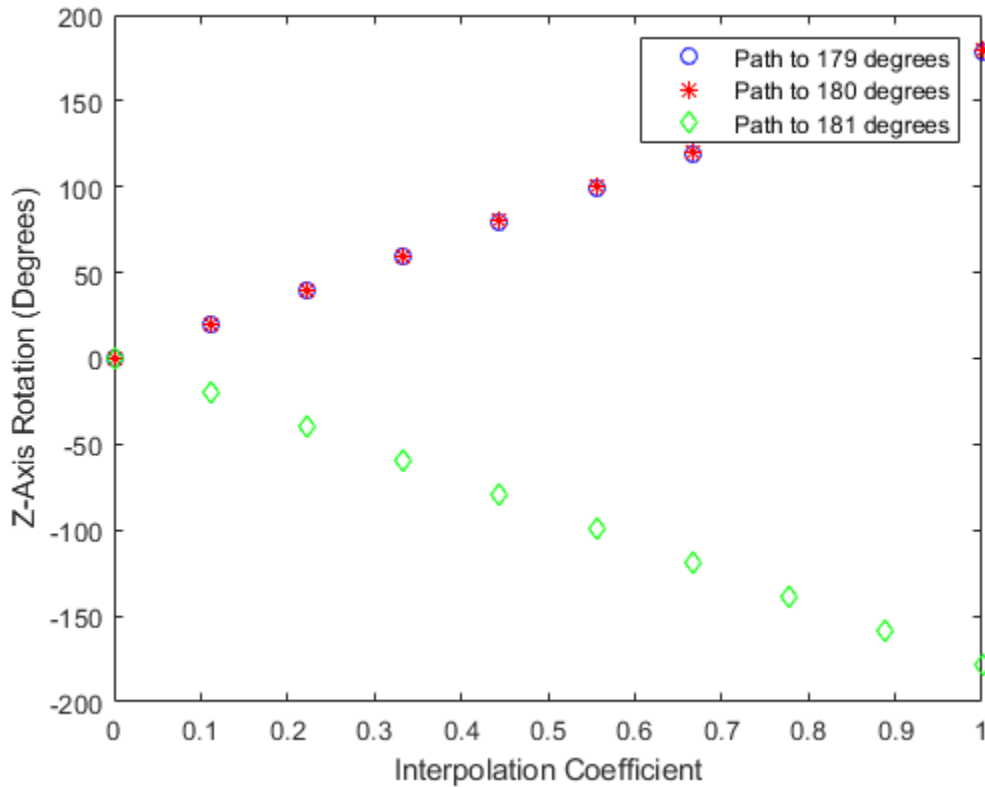

The path between q_0 and q_{179} is clockwise to minimize the great circle distance. The path between q_0 and q_{181} is counterclockwise to minimize the great circle distance. The path between q_0 and q_{180} can be either clockwise or counterclockwise, depending on numerical rounding.

Input Arguments

q1 – Quaternion

scalar | vector | matrix | multidimensional array

Quaternion to interpolate, specified as a scalar, vector, matrix, or multidimensional array of quaternions.

q_1 , q_2 , and T must have compatible sizes. In the simplest cases, they can be the same size or any one can be a scalar. Two inputs have compatible sizes if, for every dimension, the dimension sizes of the inputs are either the same or one of them is 1.

Data Types: quaternion

q2 – Quaternion

scalar | vector | matrix | multidimensional array

Quaternion to interpolate, specified as a scalar, vector, matrix, or multidimensional array of quaternions.

q_1 , q_2 , and T must have compatible sizes. In the simplest cases, they can be the same size or any one can be a scalar. Two inputs have compatible sizes if, for every dimension, the dimension sizes of the inputs are either the same or one of the dimension sizes is 1.

Data Types: quaternion

T — Interpolation coefficient

scalar | vector | matrix | multidimensional array

Interpolation coefficient, specified as a scalar, vector, matrix, or multidimensional array of numbers with each element in the range [0,1].

q_1 , q_2 , and T must have compatible sizes. In the simplest cases, they can be the same size or any one can be a scalar. Two inputs have compatible sizes if, for every dimension, the dimension sizes of the inputs are either the same or one of the dimension sizes is 1.

Data Types: single | double

Output Arguments

q0 — Interpolated quaternion

scalar | vector | matrix | multidimensional array

Interpolated quaternion, returned as a scalar, vector, matrix, or multidimensional array.

Data Types: quaternion

Algorithms

Quaternion **spherical linear interpolation** (SLERP) is an extension of linear interpolation along a plane to spherical interpolation in three dimensions. The algorithm was first proposed in [1]. Given two quaternions, q_1 and q_2 , SLERP interpolates a new quaternion, q_0 , along the great circle that connects q_1 and q_2 . The interpolation coefficient, T , determines how close the output quaternion is to either q_1 and q_2 .

The SLERP algorithm can be described in terms of sinusoids:

$$q_0 = \frac{\sin((1 - T)\theta)}{\sin(\theta)}q_1 + \frac{\sin(T\theta)}{\sin(\theta)}q_2$$

where q_1 and q_2 are normalized quaternions, and θ is half the angular distance between q_1 and q_2 .

References

- [1] Shoemake, Ken. "Animating Rotation with Quaternion Curves." *ACM SIGGRAPH Computer Graphics* Vol. 19, Issue 3, 1985, pp. 345-354.

Extended Capabilities

C/C++ Code Generation

Generate C and C++ code using MATLAB® Coder™.

See Also

Functions

dist | meanrot

Objects

quaternion

Topics

“Lowpass Filter Orientation Using Quaternion SLERP”

“Rotations, Orientation, and Quaternions”

Introduced in R2018b

classUnderlying

Class of parts within quaternion

Syntax

```
underlyingClass = classUnderlying(quat)
```

Description

`underlyingClass = classUnderlying(quat)` returns the name of the class of the parts of the quaternion `quat`.

Examples

Get Underlying Class of Quaternion

A quaternion is a four-part hyper-complex number used in three-dimensional representations. The four parts of the quaternion are of data type `single` or `double`.

Create two quaternions, one with an underlying data type of `single`, and one with an underlying data type of `double`. Verify the underlying data types by calling `classUnderlying` on the quaternions.

```
qSingle = quaternion(single([1,2,3,4]))
```

```
qSingle = quaternion
         1 + 2i + 3j + 4k
```

```
classUnderlying(qSingle)
```

```
ans =
'single'
```

```
qDouble = quaternion([1,2,3,4])
```

```
qDouble = quaternion
         1 + 2i + 3j + 4k
```

```
classUnderlying(qDouble)
```

```
ans =
'double'
```

You can separate quaternions into their parts using the `parts` function. Verify the parts of each quaternion are the correct data type. Recall that `double` is the default MATLAB® type.

```
[aS,bS,cS,dS] = parts(qSingle)
```

```
aS = single
     1
```

```
bS = single
    2
cS = single
    3
dS = single
    4

[aD,bD,cD,dD] = parts(qDouble)

aD = 1
bD = 2
cD = 3
dD = 4
```

Quaternions follow the same implicit casting rules as other data types in MATLAB. That is, a quaternion with underlying data type `single` that is combined with a quaternion with underlying data type `double` results in a quaternion with underlying data type `single`. Multiply `qDouble` and `qSingle` and verify the resulting underlying data type is `single`.

```
q = qDouble*qSingle;
classUnderlying(q)

ans =
'single'
```

Input Arguments

quat — Quaternion to investigate

scalar | vector | matrix | multi-dimensional array

Quaternion to investigate, specified as a quaternion or array of quaternions.

Data Types: quaternion

Output Arguments

underlyingClass — Underlying class of quaternion object

'single' | 'double'

Underlying class of quaternion, returned as the character vector 'single' or 'double'.

Data Types: char

Extended Capabilities

C/C++ Code Generation

Generate C and C++ code using MATLAB® Coder™.

See Also

Functions

compact | parts

Objects

quaternion

Topics

“Rotations, Orientation, and Quaternions”

Introduced in R2018b

compact

Convert quaternion array to N -by-4 matrix

Syntax

```
matrix = compact(quat)
```

Description

`matrix = compact(quat)` converts the quaternion array, `quat`, to an N -by-4 matrix. The columns are made from the four quaternion parts. The i^{th} row of the matrix corresponds to `quat(i)`.

Examples

Convert Quaternion Array to Compact Representation of Parts

Create a scalar quaternion with random parts. Convert the parts to a 1-by-4 vector using `compact`.

```
randomParts = randn(1,4)
randomParts = 1×4
    0.5377    1.8339   -2.2588    0.8622

quat = quaternion(randomParts)
quat = quaternion
    0.53767 + 1.8339i - 2.2588j + 0.86217k

quatParts = compact(quat)
quatParts = 1×4
    0.5377    1.8339   -2.2588    0.8622
```

Create a 2-by-2 array of quaternions, then convert the representation to a matrix of quaternion parts. The output rows correspond to the linear indices of the quaternion array.

```
quatArray = [quaternion([1:4;5:8]),quaternion([9:12;13:16])]
quatArray=2×2 quaternion array
    1 + 2i + 3j + 4k    9 + 10i + 11j + 12k
    5 + 6i + 7j + 8k    13 + 14i + 15j + 16k

quatArrayParts = compact(quatArray)
quatArrayParts = 4×4
```

1	2	3	4
5	6	7	8
9	10	11	12
13	14	15	16

Input Arguments

quat — Quaternion to convert

scalar | vector | matrix | multidimensional array

Quaternion to convert, specified as scalar, vector, matrix, or multidimensional array of quaternions.

Data Types: quaternion

Output Arguments

matrix — Quaternion in matrix form

N -by-4 matrix

Quaternion in matrix form, returned as an N -by-4 matrix, where $N = \text{numel}(\text{quat})$.

Data Types: single | double

Extended Capabilities

C/C++ Code Generation

Generate C and C++ code using MATLAB® Coder™.

See Also

Functions

classUnderlying | parts

Objects

quaternion

Topics

“Rotations, Orientation, and Quaternions”

Introduced in R2018b

conj

Complex conjugate of quaternion

Syntax

```
quatConjugate = conj(quat)
```

Description

`quatConjugate = conj(quat)` returns the complex conjugate of the quaternion, `quat`.

If $q = a + bi + cj + dk$, the complex conjugate of q is $q^* = a - bi - cj - dk$. Considered as a rotation operator, the conjugate performs the opposite rotation. For example,

```
q = quaternion(deg2rad([16 45 30]), 'rotvec');  
a = q*conj(q);  
rotatepoint(a, [0,1,0])
```

```
ans =
```

```
    0    1    0
```

Examples

Complex Conjugate of Quaternion

Create a quaternion scalar and get the complex conjugate.

```
q = normalize(quaternion([0.9 0.3 0.3 0.25]))  
  
q = quaternion  
    0.87727 + 0.29242i + 0.29242j + 0.24369k
```

```
qConj = conj(q)
```

```
qConj = quaternion  
    0.87727 - 0.29242i - 0.29242j - 0.24369k
```

Verify that a quaternion multiplied by its conjugate returns a quaternion one.

```
q*qConj
```

```
ans = quaternion  
    1 + 0i + 0j + 0k
```

Input Arguments

quat — Quaternion

scalar | vector | matrix | multidimensional array

Quaternion to conjugate, specified as a scalar, vector, matrix, or array of quaternions.

Data Types: quaternion

Output Arguments

quatConjugate — Quaternion conjugate

scalar | vector | matrix | multidimensional array

Quaternion conjugate, returned as a quaternion or array of quaternions the same size as `quat`.

Data Types: quaternion

Extended Capabilities

C/C++ Code Generation

Generate C and C++ code using MATLAB® Coder™.

See Also

Functions

`norm` | `times`, `.*`

Objects

quaternion

Topics

“Rotations, Orientation, and Quaternions”

Introduced in R2018b

ctranspose, '

Complex conjugate transpose of quaternion array

Syntax

```
quatTransposed = quat'
```

Description

`quatTransposed = quat'` returns the complex conjugate transpose of the quaternion, `quat`.

Examples

Vector Complex Conjugate Transpose

Create a vector of quaternions and compute its complex conjugate transpose.

```
quat = quaternion(randn(4,4))
```

```
quat=4x1 quaternion array
    0.53767 + 0.31877i + 3.5784j + 0.7254k
    1.8339 - 1.3077i + 2.7694j - 0.063055k
   -2.2588 - 0.43359i - 1.3499j + 0.71474k
    0.86217 + 0.34262i + 3.0349j - 0.20497k
```

```
quatTransposed = quat'
```

```
quatTransposed=1x4 quaternion array
    0.53767 - 0.31877i - 3.5784j - 0.7254k    1.8339 + 1.3077i - 2.7694j + 0.063055k
   -2.2588 + 0.43359i + 1.3499j - 0.71474k    0.86217 - 0.34262i - 3.0349j + 0.20497k
```

Matrix Complex Conjugate Transpose

Create a matrix of quaternions and compute its complex conjugate transpose.

```
quat = [quaternion(randn(2,4)), quaternion(randn(2,4))]
```

```
quat=2x2 quaternion array
    0.53767 - 2.2588i + 0.31877j - 0.43359k    3.5784 - 1.3499i + 0.7254j + 0.71474k
    1.8339 + 0.86217i - 1.3077j + 0.34262k    2.7694 + 3.0349i - 0.063055j - 0.20497k
```

```
quatTransposed = quat'
```

```
quatTransposed=2x2 quaternion array
    0.53767 + 2.2588i - 0.31877j + 0.43359k    1.8339 - 0.86217i + 1.3077j - 0.34262k
    3.5784 + 1.3499i - 0.7254j - 0.71474k    2.7694 - 3.0349i + 0.063055j + 0.20497k
```

Input Arguments

quat — Quaternion to transpose

scalar | vector | matrix

Quaternion to transpose, specified as a vector or matrix or quaternions. The complex conjugate transpose is defined for 1-D and 2-D arrays.

Data Types: quaternion

Output Arguments

quatTransposed — Conjugate transposed quaternion

scalar | vector | matrix

Conjugate transposed quaternion, returned as an N -by- M array, where `quat` was specified as an M -by- N array.

Data Types: quaternion

Extended Capabilities

C/C++ Code Generation

Generate C and C++ code using MATLAB® Coder™.

See Also

Functions

`transpose, '`

Objects

quaternion

Topics

“Rotations, Orientation, and Quaternions”

Introduced in R2018b

transformMotion

Compute motion quantities between two relatively fixed frames

Syntax

```
[posS,orientS,velS,accS,angvelS] = transformMotion(posSFromP,orientSFromP,
posP)
[ ___ ] = transformMotion(posSFromP,orientSFromP,posP,orientP)
[ ___ ] = transformMotion(posSFromP,orientSFromP,posP,orientP,velP)
[ ___ ] = transformMotion(posSFromP,orientSFromP,posP,orientP,velP,accP)
[ ___ ] = transformMotion(posSFromP,orientSFromP,posP,orientP,velP,accP,
angvelP)
```

Description

[posS,orientS,velS,accS,angvelS] = transformMotion(posSFromP,orientSFromP, posP) computes motion quantities of the sensor frame relative to the navigation frame (posS, orientS, velS, accS, and angvelS) using the position of sensor frame relative to the platform frame, posSFromP, the orientation of the sensor frame relative to the platform frame, orientSFromP, and the position of the platform frame relative to the navigation frame, posP. Note that the position and orientation between the sensor frame and the platform frame are assumed to be fixed. Also, the unspecified quantities between the navigation frame and the platform frame (such as orientation, velocity, and acceleration) are assumed to be zero.

[___] = transformMotion(posSFromP,orientSFromP,posP,orientP) additionally specifies the orientation of the platform frame relative to the navigation frame, orientP. The output arguments are the same as those of the previous syntax.

[___] = transformMotion(posSFromP,orientSFromP,posP,orientP,velP) additionally specifies the velocity of the platform frame relative to the navigation frame, velP. The output arguments are the same as those of the previous syntax.

[___] = transformMotion(posSFromP,orientSFromP,posP,orientP,velP,accP) additionally specifies the acceleration of the platform frame relative to the navigation frame, accP. The output arguments are the same as those of the previous syntax.

[___] = transformMotion(posSFromP,orientSFromP,posP,orientP,velP,accP, angvelP) additionally specifies the angular velocity of the platform frame relative to the navigation frame, angvelP. The output arguments are the same as those of the previous syntax.

Examples

Transform State to Sensor Frame

Define the pose, velocity, and acceleration of the platform frame relative to the navigation frame.

```
posPlat = [20 -1 0];
orientPlat = quaternion(1, 0, 0, 0);
velPlat = [0 0 0];
```

```
accPlat = [0 0 0];
angvelPlat = [0 0 1];
```

Define the position and orientation offset of IMU sensor frame relative to the platform frame.

```
posPlat2IMU = [1 2 3];
orientPlat2IMU = quaternion([45 0 0], 'eulerd', 'ZYX', 'frame');
```

Calculate the motion quantities of the sensor frame relative to the navigation frame and print the results.

```
[posIMU, orientIMU, velIMU, accIMU, angvelIMU] ...
    = transformMotion(posPlat2IMU, orientPlat2IMU, ...
        posPlat, orientPlat, velPlat, accPlat, angvelPlat);
```

```
fprintf('IMU position is:\n');
```

```
IMU position is:
```

```
fprintf('%.2f %.2f %.2f\n', posIMU);
```

```
21.00 1.00 3.00
```

```
orientIMU
```

```
orientIMU = quaternion
    0.92388 +      0i +      0j + 0.38268k
```

```
velIMU
```

```
velIMU = 1×3
```

```
    -2     1     0
```

```
accPlat
```

```
accPlat = 1×3
```

```
     0     0     0
```

Input Arguments

posSFromP — Position of sensor frame relative to platform frame

1-by-3 vector of real scalars

Position of the sensor frame relative to the platform frame, specified as a 1-by-3 vector of real scalars.

Example: [1 2 3]

orientSFromP — Orientation of sensor frame relative to platform frame

quaternion | 3-by-3 rotation matrix

Orientation of the sensor frame relative to the platform frame, specified as a quaternion or a 3-by-3 rotation matrix.

Example: `quaternion(1,0,0,0)`

posP — Position of platform frame relative to navigation frame

N-by-3 matrix of real scalars

Position of platform frame relative to navigation frame, specified as an *N*-by-3 matrix of real scalars. *N* is the number of position quantities.

Example: `[1 2 3]`

orientP — Orientation of platform frame relative to navigation frame

N-by-1 array of quaternion | 3-by-3-by-*N* array of scalars

Orientation of platform frame relative to navigation frame, specified as an *N*-by-1 array of quaternions, or a 3-by-3-by-*N* array of scalars. Each 3-by-3 matrix must be a rotation matrix. *N* is the number of orientation quantities.

Example: `quaternion(1,0,0,0)`

velP — Velocity of platform frame relative to navigation frame

N-by-3 matrix of real scalars

Velocity of platform frame relative to navigation frame, specified as an *N*-by-3 matrix of real scalars. *N* is the number of velocity quantities.

Example: `[4 8 6]`

accP — Acceleration of platform frame relative to navigation frame

N-by-3 matrix of real scalars

Acceleration of platform frame relative to navigation frame, specified as an *N*-by-3 matrix of real scalars. *N* is the number of acceleration quantities.

Example: `[4 8 6]`

angvelP — Angular velocity of platform frame relative to navigation frame

N-by-3 matrix of real scalars

Angular velocity of platform frame relative to navigation frame, specified as an *N*-by-3 matrix of real scalars. *N* is the number of angular velocity quantities.

Example: `[4 2 3]`

Output Arguments

posS — Position of sensor frame relative to navigation frame

N-by-3 matrix of real scalars

Position of sensor frame relative to navigation frame, returned as an *N*-by-3 matrix of real scalars. *N* is the number of position quantities specified by the `posP` input.

orientS — Orientation of sensor frame relative to navigation frame

N-by-1 array of quaternion | 3-by-3-by-*N* array of scalars

Orientation of sensor frame relative to navigation frame, returned as an *N*-by-1 array of quaternions, or a 3-by-3-by-*N* array of scalars. *N* is the number of orientation quantities specified by the `orientP` input. The returned orientation quantity type is same with the `orientP` input.

velS — Velocity of sensor frame relative to navigation frame*N*-by-3 matrix of real scalars

Velocity of sensor frame relative to navigation frame, returned as an *N*-by-3 matrix of real scalars. *N* is the number of position quantities specified by the velP input.

accS — Acceleration of sensor frame relative to navigation frame*N*-by-3 matrix of real scalars

Acceleration of sensor frame relative to navigation frame, returned as an *N*-by-3 matrix of real scalars. *N* is the number of position quantities specified by the accP input.

angvelS — Angular velocity of sensor frame relative to navigation frame*N*-by-3 matrix of real scalars

Angular velocity of sensor frame relative to navigation frame, returned as an *N*-by-3 matrix of real scalars. *N* is the number of position quantities specified by the angvelP input.

More About**Motion Quantities Used in transformMotion**

The transformMotion function calculates the motion quantities of the sensor frame (*S*), which is fixed on a rigid platform, relative to the navigation frame (*N*) using the mounting information of the sensor on the platform and the motion information of the platform frame (*P*).

As shown in the figure, the position and orientation of the platform frame and the sensor frame are fixed on the platform. The position of the sensor frame relative to the platform frame is p_{SP} , and the orientation of the sensor frame relative to the platform frame is r_{SP} . Since the two frames are both fixed, p_{SP} and r_{SP} are constant.

To compute the motion quantities of the sensor frame relative to the navigation frame, the quantities describing the motion of the platform frame relative to the navigation frame are required. These quantities include: the platform position (p_{PN}), orientation (r_{PN}), velocity, acceleration, angular velocity, and angular acceleration relative to the navigation frame. You can specify these quantities through the function input arguments except the angular acceleration, which is always assumed to be zero in the function. The unspecified quantities are also assumed to be zero.

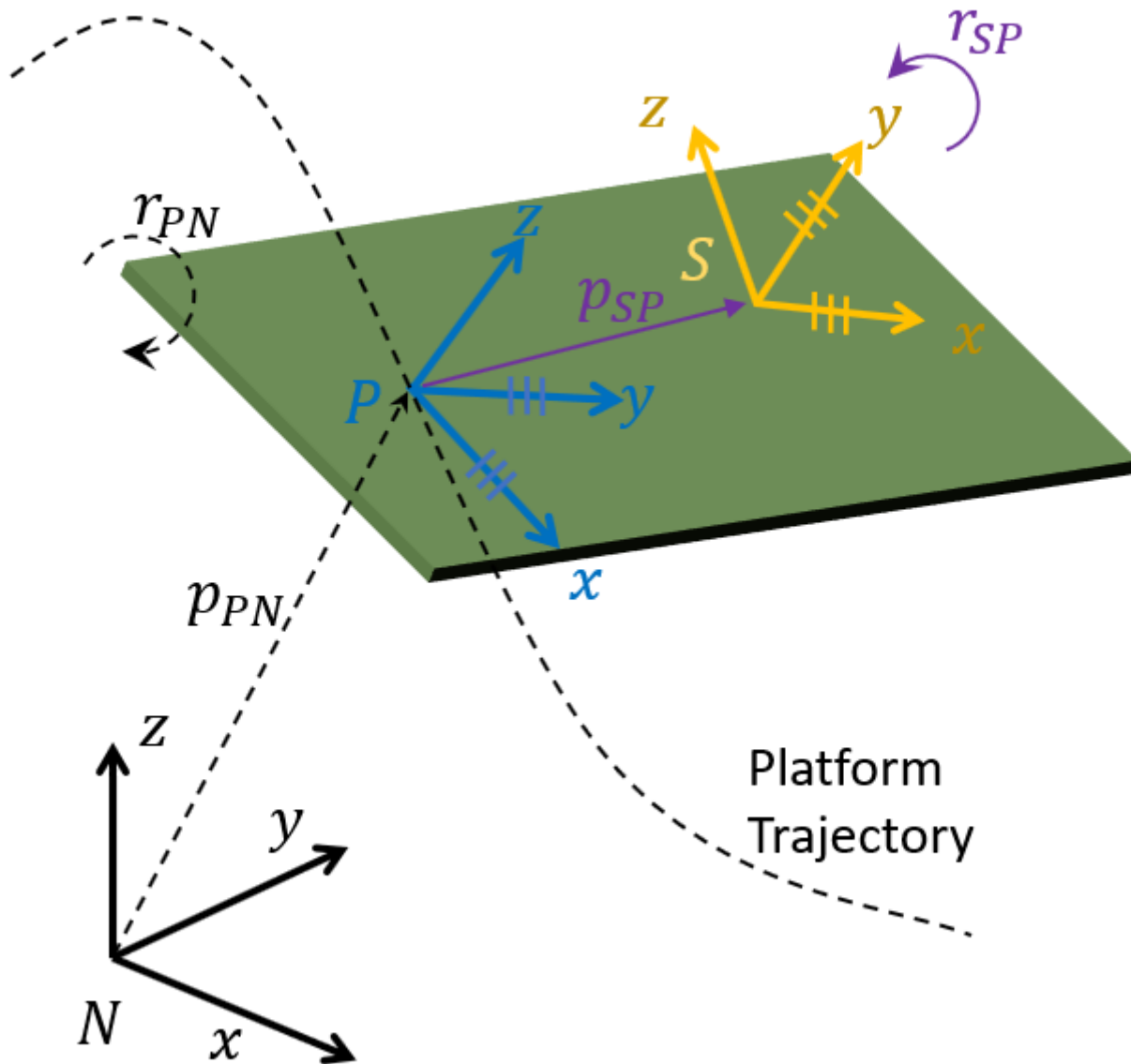

See Also

Introduced in R2020a

dist

Angular distance in radians

Syntax

```
distance = dist(quatA,quatB)
```

Description

`distance = dist(quatA,quatB)` returns the angular distance in radians between two quaternions, `quatA` and `quatB`.

Examples

Calculate Quaternion Distance

Calculate the quaternion distance between a single quaternion and each element of a vector of quaternions. Define the quaternions using Euler angles.

```
q = quaternion([0,0,0], 'eulerd', 'zyx', 'frame')
```

```
q = quaternion
    1 + 0i + 0j + 0k
```

```
qArray = quaternion([0,45,0;0,90,0;0,180,0;0,-90,0;0,-45,0], 'eulerd', 'zyx', 'frame')
```

```
qArray=5x1 quaternion array
    0.92388 +      0i + 0.38268j +      0k
    0.70711 +      0i + 0.70711j +      0k
    6.1232e-17 +      0i +      1j +      0k
    0.70711 +      0i - 0.70711j +      0k
    0.92388 +      0i - 0.38268j +      0k
```

```
quaternionDistance = rad2deg(dist(q,qArray))
```

```
quaternionDistance = 5x1
    45.0000
    90.0000
   180.0000
    90.0000
    45.0000
```

If both arguments to `dist` are vectors, the quaternion distance is calculated between corresponding elements. Calculate the quaternion distance between two quaternion vectors.

```
angles1 = [30,0,15; ...
           30,5,15; ...
```

```
        30,10,15; ...
        30,15,15];
angles2 = [30,6,15; ...
          31,11,15; ...
          30,16,14; ...
          30.5,21,15.5];

qVector1 = quaternion(angles1,'eulerd','zyx','frame');
qVector2 = quaternion(angles2,'eulerd','zyx','frame');

rad2deg(dist(qVector1,qVector2))

ans = 4×1

    6.0000
    6.0827
    6.0827
    6.0287
```

Note that a quaternion represents the same rotation as its negative. Calculate a quaternion and its negative.

```
qPositive = quaternion([30,45,-60],'eulerd','zyx','frame')

qPositive = quaternion
    0.72332 - 0.53198i + 0.20056j + 0.3919k

qNegative = -qPositive

qNegative = quaternion
   -0.72332 + 0.53198i - 0.20056j - 0.3919k
```

Find the distance between the quaternion and its negative.

```
dist(qPositive,qNegative)

ans = 0
```

The components of a quaternion may look different from the components of its negative, but both expressions represent the same rotation.

Input Arguments

quatA, quatB — Quaternions to calculate distance between

scalar | vector | matrix | multidimensional array

Quaternions to calculate distance between, specified as comma-separated quaternions or arrays of quaternions. `quatA` and `quatB` must have compatible sizes:

- `size(quatA) == size(quatB)`, or
- `numel(quatA) == 1`, or
- `numel(quatB) == 1`, or

- if $[Adim1, \dots, AdimN] = \text{size}(\text{quatA})$ and $[Bdim1, \dots, BdimN] = \text{size}(\text{quatB})$, then for $i = 1:N$, either $Adimi == Bdimi$ or $Adim == 1$ or $Bdim == 1$.

If one of the quaternion arguments contains only one quaternion, then this function returns the distances between that quaternion and every quaternion in the other argument.

Data Types: quaternion

Output Arguments

distance — Angular distance (radians)

scalar | vector | matrix | multidimensional array

Angular distance in radians, returned as an array. The dimensions are the maximum of the union of $\text{size}(\text{quatA})$ and $\text{size}(\text{quatB})$.

Data Types: single | double

Algorithms

The `dist` function returns the angular distance between two quaternions.

A quaternion may be defined by an axis (u_b, u_c, u_d) and angle of rotation θ_q :

$$q = \cos\left(\frac{\theta_q}{2}\right) + \sin\left(\frac{\theta_q}{2}\right)(u_b i + u_c j + u_d k).$$

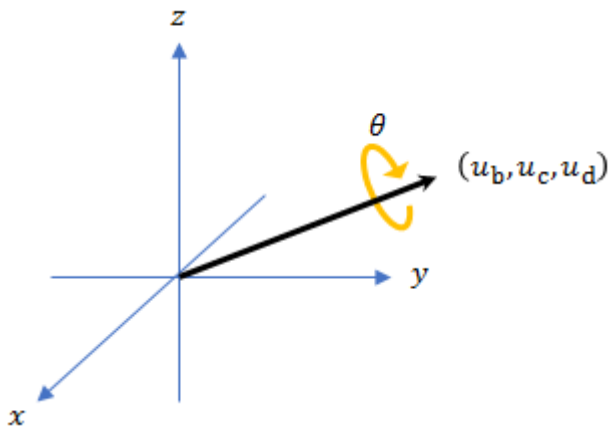

Given a quaternion in the form, $q = a + bi + cj + dk$, where a is the real part, you can solve for the angle of q as $\theta_q = 2\cos^{-1}(a)$.

Consider two quaternions, p and q , and the product $z = p * \text{conjugate}(q)$. As p approaches q , the angle of z goes to 0, and z approaches the unit quaternion.

The angular distance between two quaternions can be expressed as $\theta_z = 2\cos^{-1}(\text{real}(z))$.

Using the quaternion data type syntax, the angular distance is calculated as:

```
angularDistance = 2*acos(abs(parts(p*conj(q))));
```

Extended Capabilities

C/C++ Code Generation

Generate C and C++ code using MATLAB® Coder™.

See Also

Functions

conj | parts

Objects

quaternion

Topics

“Rotations, Orientation, and Quaternions”

Introduced in R2018b

euler

Convert quaternion to Euler angles (radians)

Syntax

```
eulerAngles = euler(quat, rotationSequence, rotationType)
```

Description

`eulerAngles = euler(quat, rotationSequence, rotationType)` converts the quaternion, `quat`, to an N -by-3 matrix of Euler angles.

Examples

Convert Quaternion to Euler Angles in Radians

Convert a quaternion frame rotation to Euler angles in radians using the 'ZYX' rotation sequence.

```
quat = quaternion([0.7071 0.7071 0 0]);
eulerAnglesRadians = euler(quat, 'ZYX', 'frame')
```

```
eulerAnglesRadians = 1×3
    0         0    1.5708
```

Input Arguments

quat — Quaternion to convert to Euler angles

scalar | vector | matrix | multidimensional array

Quaternion to convert to Euler angles, specified as a scalar, vector, matrix, or multidimensional array of quaternions.

Data Types: quaternion

rotationSequence — Rotation sequence

'ZYX' | 'YZX' | 'ZYX' | 'ZYX' | 'ZYX' | 'ZYX' | 'ZYX' | 'ZYX' | 'ZYX' | 'ZYX'

Rotation sequence of Euler representation, specified as a character vector or string.

The rotation sequence defines the order of rotations about the axes. For example, if you specify a rotation sequence of 'YZX':

- 1 The first rotation is about the y-axis.
- 2 The second rotation is about the new z-axis.
- 3 The third rotation is about the new x-axis.

Data Types: char | string

rotationType — Type of rotation

'point' | 'frame'

Type of rotation, specified as 'point' or 'frame'.

In a point rotation, the frame is static and the point moves. In a frame rotation, the point is static and the frame moves. Point rotation and frame rotation define equivalent angular displacements but in opposite directions.

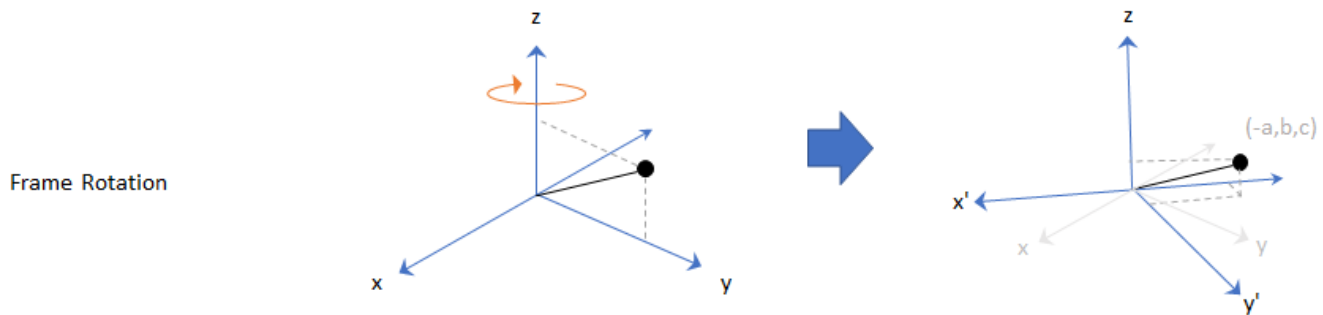
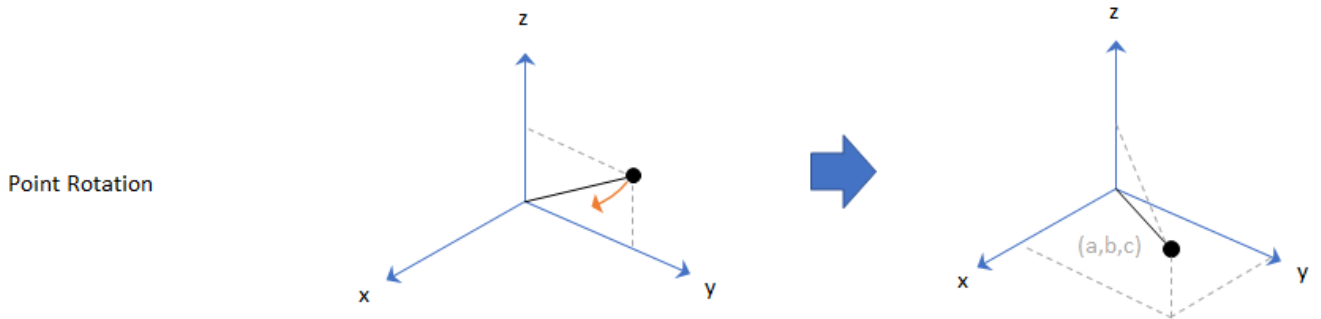

Data Types: char | string

Output Arguments**eulerAngles — Euler angle representation (radians)***N*-by-3 matrix

Euler angle representation in radians, returned as a *N*-by-3 matrix. *N* is the number of quaternions in the `quat` argument.

For each row of `eulerAngles`, the first element corresponds to the first axis in the rotation sequence, the second element corresponds to the second axis in the rotation sequence, and the third element corresponds to the third axis in the rotation sequence.

The data type of the Euler angles representation is the same as the underlying data type of `quat`.

Data Types: single | double

Extended Capabilities

C/C++ Code Generation

Generate C and C++ code using MATLAB® Coder™.

See Also

Functions

eulerd | rotateframe | rotatepoint

Objects

quaternion

Topics

“Rotations, Orientation, and Quaternions”

Introduced in R2018b

exp

Exponential of quaternion array

Syntax

`B = exp(A)`

Description

`B = exp(A)` computes the exponential of the elements of the quaternion array `A`.

Examples

Exponential of Quaternion Array

Create a 4-by-1 quaternion array `A`.

```
A = quaternion(magic(4))
```

```
A=4×1 quaternion array
    16 + 2i + 3j + 13k
     5 + 11i + 10j + 8k
     9 + 7i + 6j + 12k
     4 + 14i + 15j + 1k
```

Compute the exponential of `A`.

```
B = exp(A)
```

```
B=4×1 quaternion array
 5.3525e+06 + 1.0516e+06i + 1.5774e+06j + 6.8352e+06k
 -57.359 - 89.189i - 81.081j - 64.865k
 -6799.1 + 2039.1i + 1747.8j + 3495.6k
 -6.66 + 36.931i + 39.569j + 2.6379k
```

Input Arguments

A — Input quaternion

scalar | vector | matrix | multidimensional array

Input quaternion, specified as a scalar, vector, matrix, or multidimensional array.

Data Types: quaternion

Output Arguments

B — Result

scalar | vector | matrix | multidimensional array

Result of quaternion exponential, returned as a scalar, vector, matrix, or multidimensional array.

Data Types: quaternion

Algorithms

Given a quaternion $A = a + bi + cj + dk = a + \bar{v}$, the exponential is computed by

$$\exp(A) = e^a \left(\cos\|\bar{v}\| + \frac{\bar{v}}{\|\bar{v}\|} \sin\|\bar{v}\| \right)$$

Extended Capabilities

C/C++ Code Generation

Generate C and C++ code using MATLAB® Coder™.

See Also

Functions

log | power, .^

Objects

quaternion

Topics

“Rotations, Orientation, and Quaternions”

Introduced in R2018b

ldivide, .\

Element-wise quaternion left division

Syntax

```
C = A.\B
```

Description

`C = A.\B` performs quaternion element-wise division by dividing each element of quaternion B by the corresponding element of quaternion A.

Examples

Divide a Quaternion Array by a Real Scalar

Create a 2-by-1 quaternion array, and divide it element-by-element by a real scalar.

```
A = quaternion([1:4;5:8])
```

```
A=2×1 quaternion array
    1 + 2i + 3j + 4k
    5 + 6i + 7j + 8k
```

```
B = 2;
C = A.\B
```

```
C=2×1 quaternion array
    0.066667 - 0.133333i - 0.2j - 0.26667k
    0.057471 - 0.068966i - 0.08046j - 0.091954k
```

Divide a Quaternion Array by Another Quaternion Array

Create a 2-by-2 quaternion array, and divide it element-by-element by another 2-by-2 quaternion array.

```
q1 = quaternion([1:4;2:5;4:7;5:8]);
A = reshape(q1,2,2)
```

```
A=2×2 quaternion array
    1 + 2i + 3j + 4k    4 + 5i + 6j + 7k
    2 + 3i + 4j + 5k    5 + 6i + 7j + 8k
```

```
q2 = quaternion(magic(4));
B = reshape(q2,2,2)
```

B=2×2 quaternion array

$$\begin{array}{r} 16 + 2i + 3j + 13k \\ 5 + 11i + 10j + 8k \end{array} \quad \begin{array}{r} 9 + 7i + 6j + 12k \\ 4 + 14i + 15j + 1k \end{array}$$

C = A.\B

C=2×2 quaternion array

$$\begin{array}{r} 2.7 - 1.9i - 0.9j - 1.7k \\ 2.2778 + 0.46296i - 0.57407j + 0.092593k \end{array} \quad \begin{array}{r} 1.5159 - 0.37302i - 0.15079j - 0.0238 \\ 1.2471 + 0.91379i - 0.33908j - 0.109 \end{array}$$

Input Arguments

A — Divisor

scalar | vector | matrix | multidimensional array

Divisor, specified as a quaternion, an array of quaternions, a real scalar, or an array of real numbers.

A and B must have compatible sizes. In the simplest cases, they can be the same size or one can be a scalar. Two inputs have compatible sizes if, for every dimension, the dimension sizes of the inputs are the same or one of the dimensions is 1.

Data Types: quaternion | single | double

B — Dividend

scalar | vector | matrix | multidimensional array

Dividend, specified as a quaternion, an array of quaternions, a real scalar, or an array of real numbers.

A and B must have compatible sizes. In the simplest cases, they can be the same size or one can be a scalar. Two inputs have compatible sizes if, for every dimension, the dimension sizes of the inputs are the same or one of the dimensions is 1.

Data Types: quaternion | single | double

Output Arguments

C — Result

scalar | vector | matrix | multidimensional array

Result of quaternion division, returned as a scalar, vector, matrix, or multidimensional array.

Data Types: quaternion

Algorithms

Quaternion Division

Given a quaternion $A = a_1 + a_2i + a_3j + a_4k$ and a real scalar p ,

$$C = p.\backslash A = \frac{a_1}{p} + \frac{a_2}{p}i + \frac{a_3}{p}j + \frac{a_4}{p}k$$

Note For a real scalar p , $A./p = A.\backslash p$.

Quaternion Division by a Quaternion Scalar

Given two quaternions A and B of compatible sizes, then

$$C = A.\backslash B = A^{-1} .* B = \left(\frac{\text{conj}(A)}{\text{norm}(A)^2} \right) .* B$$

Extended Capabilities

C/C++ Code Generation

Generate C and C++ code using MATLAB® Coder™.

See Also

Functions

`conj` | `norm` | `rdivide`, `./` | `times`, `.*`

Objects

`quaternion`

Topics

“Rotations, Orientation, and Quaternions”

Introduced in R2018b

log

Natural logarithm of quaternion array

Syntax

$B = \log(A)$

Description

$B = \log(A)$ computes the natural logarithm of the elements of the quaternion array A .

Examples

Logarithmic Values of Quaternion Array

Create a 3-by-1 quaternion array A .

```
A = quaternion(randn(3,4))
```

```
A=3×1 quaternion array
    0.53767 + 0.86217i - 0.43359j + 2.7694k
    1.8339 + 0.31877i + 0.34262j - 1.3499k
   -2.2588 - 1.3077i + 3.5784j + 3.0349k
```

Compute the logarithmic values of A .

```
B = log(A)
```

```
B=3×1 quaternion array
    1.0925 + 0.40848i - 0.20543j + 1.3121k
    0.8436 + 0.14767i + 0.15872j - 0.62533k
    1.6807 - 0.53829i + 1.473j + 1.2493k
```

Input Arguments

A — Input array

scalar | vector | matrix | multidimensional array

Input array, specified as a scalar, vector, matrix, or multidimensional array.

Data Types: quaternion

Output Arguments

B — Logarithm values

scalar | vector | matrix | multidimensional array

Quaternion natural logarithm values, returned as a scalar, vector, matrix, or multidimensional array.

Data Types: quaternion

Algorithms

Given a quaternion $A = a + \bar{v} = a + bi + cj + dk$, the logarithm is computed by

$$\log(A) = \log\|A\| + \frac{\bar{v}}{\|\bar{v}\|} \arccos \frac{a}{\|A\|}$$

Extended Capabilities

C/C++ Code Generation

Generate C and C++ code using MATLAB® Coder™.

See Also

Functions

`exp` | `power`, `.^`

Objects

quaternion

Topics

“Rotations, Orientation, and Quaternions”

Introduced in R2018b

minus, -

Quaternion subtraction

Syntax

$$C = A - B$$

Description

$C = A - B$ subtracts quaternion B from quaternion A using quaternion subtraction. Either A or B may be a real number, in which case subtraction is performed with the real part of the quaternion argument.

Examples

Subtract a Quaternion from a Quaternion

Quaternion subtraction is defined as the subtraction of the corresponding parts of each quaternion. Create two quaternions and perform subtraction.

```
Q1 = quaternion([1,0,-2,7]);
Q2 = quaternion([1,2,3,4]);
```

```
Q1minusQ2 = Q1 - Q2
```

```
Q1minusQ2 = quaternion
    0 - 2i - 5j + 3k
```

Subtract a Real Number from a Quaternion

Addition and subtraction of real numbers is defined for quaternions as acting on the real part of the quaternion. Create a quaternion and then subtract 1 from the real part.

```
Q = quaternion([1,1,1,1])
```

```
Q = quaternion
    1 + 1i + 1j + 1k
```

```
Qminus1 = Q - 1
```

```
Qminus1 = quaternion
    0 + 1i + 1j + 1k
```

Input Arguments

A — Input

scalar | vector | matrix | multidimensional array

Input, specified as a quaternion, array of quaternions, real number, or array of real numbers.

Data Types: quaternion | single | double

B — Input

scalar | vector | matrix | multidimensional array

Input, specified as a quaternion, array of quaternions, real number, or array of real numbers.

Data Types: quaternion | single | double

Output Arguments

C — Result

scalar | vector | matrix | multidimensional array

Result of quaternion subtraction, returned as a scalar, vector, matrix, or multidimensional array of quaternions.

Data Types: quaternion

Extended Capabilities

C/C++ Code Generation

Generate C and C++ code using MATLAB® Coder™.

See Also

Functions

mtimes, * | times, .* | uminus, -

Objects

quaternion

Topics

“Rotations, Orientation, and Quaternions”

Introduced in R2018b

mtimes, *

Quaternion multiplication

Syntax

```
quatC = A*B
```

Description

`quatC = A*B` implements quaternion multiplication if either A or B is a quaternion. Either A or B must be a scalar.

You can use quaternion multiplication to compose rotation operators:

- To compose a sequence of frame rotations, multiply the quaternions in the order of the desired sequence of rotations. For example, to apply a p quaternion followed by a q quaternion, multiply in the order pq . The rotation operator becomes $(pq)^*v(pq)$, where v represents the object to rotate specified in quaternion form. $*$ represents conjugation.
- To compose a sequence of point rotations, multiply the quaternions in the reverse order of the desired sequence of rotations. For example, to apply a p quaternion followed by a q quaternion, multiply in the reverse order, qp . The rotation operator becomes $(qp)v(qp)^*$.

Examples

Multiply Quaternion Scalar and Quaternion Vector

Create a 4-by-1 column vector, A, and a scalar, b. Multiply A times b.

```
A = quaternion(randn(4,4))
```

```
A=4x1 quaternion array
```

```

0.53767 + 0.31877i + 3.5784j + 0.7254k
1.8339 - 1.3077i + 2.7694j - 0.063055k
-2.2588 - 0.43359i - 1.3499j + 0.71474k
0.86217 + 0.34262i + 3.0349j - 0.20497k

```

```
b = quaternion(randn(1,4))
```

```
b = quaternion
```

```
-0.12414 + 1.4897i + 1.409j + 1.4172k
```

```
C = A*b
```

```
C=4x1 quaternion array
```

```

-6.6117 + 4.8105i + 0.94224j - 4.2097k
-2.0925 + 6.9079i + 3.9995j - 3.3614k
1.8155 - 6.2313i - 1.336j - 1.89k
-4.6033 + 5.8317i + 0.047161j - 2.791k

```

Input Arguments

A — Input

scalar | vector | matrix | multidimensional array

Input to multiply, specified as a quaternion, array of quaternions, real scalar, or array of real scalars.

If B is nonscalar, then A must be scalar.

Data Types: quaternion | single | double

B — Input

scalar | vector | matrix | multidimensional array

Input to multiply, specified as a quaternion, array of quaternions, real scalar, or array of real scalars.

If A is nonscalar, then B must be scalar.

Data Types: quaternion | single | double

Output Arguments

quatC — Quaternion product

scalar | vector | matrix | multidimensional array

Quaternion product, returned as a quaternion or array of quaternions.

Data Types: quaternion

Algorithms

Quaternion Multiplication by a Real Scalar

Given a quaternion

$$q = a_q + b_q i + c_q j + d_q k,$$

the product of q and a real scalar β is

$$\beta q = \beta a_q + \beta b_q i + \beta c_q j + \beta d_q k$$

Quaternion Multiplication by a Quaternion Scalar

The definition of the basis elements for quaternions,

$$i^2 = j^2 = k^2 = ijk = -1,$$

can be expanded to populate a table summarizing quaternion basis element multiplication:

	1	i	j	k
1	1	i	j	k
i	i	-1	k	-j

j	j	-k	-1	i
k	k	j	-i	-1

When reading the table, the rows are read first, for example: $ij = k$ and $ji = -k$.

Given two quaternions, $q = a_q + b_q i + c_q j + d_q k$, and $p = a_p + b_p i + c_p j + d_p k$, the multiplication can be expanded as:

$$\begin{aligned}
 z = pq &= (a_p + b_p i + c_p j + d_p k)(a_q + b_q i + c_q j + d_q k) \\
 &= a_p a_q + a_p b_q i + a_p c_q j + a_p d_q k \\
 &\quad + b_p a_q i + b_p b_q i^2 + b_p c_q j + b_p d_q i k \\
 &\quad + c_p a_q j + c_p b_q j i + c_p c_q j^2 + c_p d_q j k \\
 &\quad + d_p a_q k + d_p b_q k i + d_p c_q k j + d_p d_q k^2
 \end{aligned}$$

You can simplify the equation using the quaternion multiplication table:

$$\begin{aligned}
 z = pq &= a_p a_q + a_p b_q i + a_p c_q j + a_p d_q k \\
 &\quad + b_p a_q i - b_p b_q + b_p c_q k - b_p d_q j \\
 &\quad + c_p a_q j - c_p b_q k - c_p c_q + c_p d_q i \\
 &\quad + d_p a_q k + d_p b_q j - d_p c_q i - d_p d_q
 \end{aligned}$$

References

- [1] Kuipers, Jack B. *Quaternions and Rotation Sequences: A Primer with Applications to Orbits, Aerospace, and Virtual Reality*. Princeton, NJ: Princeton University Press, 2007.

Extended Capabilities

C/C++ Code Generation

Generate C and C++ code using MATLAB® Coder™.

See Also

Functions

times, .*

Objects

quaternion

Topics

“Rotations, Orientation, and Quaternions”

Introduced in R2018b

norm

Quaternion norm

Syntax

```
N = norm(quat)
```

Description

`N = norm(quat)` returns the norm of the quaternion, `quat`.

Given a quaternion of the form $Q = a + bi + cj + dk$, the norm of the quaternion is defined as $\text{norm}(Q) = \sqrt{a^2 + b^2 + c^2 + d^2}$.

Examples

Calculate Quaternion Norm

Create a scalar quaternion and calculate its norm.

```
quat = quaternion(1,2,3,4);  
norm(quat)
```

```
ans = 5.4772
```

The quaternion norm is defined as the square root of the sum of the quaternion parts squared. Calculate the quaternion norm explicitly to verify the result of the `norm` function.

```
[a,b,c,d] = parts(quat);  
sqrt(a^2+b^2+c^2+d^2)
```

```
ans = 5.4772
```

Input Arguments

quat — Quaternion

scalar | vector | matrix | multidimensional array

Quaternion for which to calculate the norm, specified as a scalar, vector, matrix, or multidimensional array of quaternions.

Data Types: quaternion

Output Arguments

N — Quaternion norm

scalar | vector | matrix | multidimensional array

Quaternion norm. If the input `quat` is an array, the output is returned as an array the same size as `quat`. Elements of the array are real numbers with the same data type as the underlying data type of the quaternion, `quat`.

Data Types: `single` | `double`

Extended Capabilities

C/C++ Code Generation

Generate C and C++ code using MATLAB® Coder™.

See Also

Functions

`conj` | `normalize` | `parts`

Objects

`quaternion`

Topics

“Rotations, Orientation, and Quaternions”

Introduced in R2018b

normalize

Quaternion normalization

Syntax

```
quatNormalized = normalize(quat)
```

Description

`quatNormalized = normalize(quat)` normalizes the quaternion.

Given a quaternion of the form $Q = a + bi + cj + dk$, the normalized quaternion is defined as $Q/\sqrt{a^2 + b^2 + c^2 + d^2}$.

Examples

Normalize Elements of Quaternion Vector

Quaternions can represent rotations when normalized. You can use `normalize` to normalize a scalar, elements of a matrix, or elements of a multi-dimensional array of quaternions. Create a column vector of quaternions, then normalize them.

```
quatArray = quaternion([1,2,3,4; ...  
                      2,3,4,1; ...  
                      3,4,1,2]);  
quatArrayNormalized = normalize(quatArray)  
  
quatArrayNormalized=3×1 quaternion array  
    0.18257 + 0.36515i + 0.54772j + 0.7303k  
    0.36515 + 0.54772i + 0.7303j + 0.18257k  
    0.54772 + 0.7303i + 0.18257j + 0.36515k
```

Input Arguments

quat — Quaternion to normalize

scalar | vector | matrix | multidimensional array

Quaternion to normalize, specified as a scalar, vector, matrix, or multidimensional array of quaternions.

Data Types: quaternion

Output Arguments

quatNormalized — Normalized quaternion

scalar | vector | matrix | multidimensional array

Normalized quaternion, returned as a quaternion or array of quaternions the same size as `quat`.

Data Types: `quaternion`

Extended Capabilities

C/C++ Code Generation

Generate C and C++ code using MATLAB® Coder™.

See Also

Functions

`conj` | `norm` | `times`, `.*`

Objects

`quaternion`

Topics

“Rotations, Orientation, and Quaternions”

Introduced in R2018b

ones

Create quaternion array with real parts set to one and imaginary parts set to zero

Syntax

```
quat0nes = ones('quaternion')
quat0nes = ones(n,'quaternion')
quat0nes = ones(sz,'quaternion')
quat0nes = ones(sz1,...,szN,'quaternion')

quat0nes = ones( ____, 'like', prototype, 'quaternion')
```

Description

`quat0nes = ones('quaternion')` returns a scalar quaternion with the real part set to 1 and the imaginary parts set to 0.

Given a quaternion of the form $Q = a + bi + cj + dk$, a quaternion one is defined as $Q = 1 + 0i + 0j + 0k$.

`quat0nes = ones(n,'quaternion')` returns an n-by-n quaternion matrix with the real parts set to 1 and the imaginary parts set to 0.

`quat0nes = ones(sz,'quaternion')` returns an array of quaternion ones where the size vector, `sz`, defines `size(q0nes)`.

Example: `ones([1,4,2],'quaternion')` returns a 1-by-4-by-2 array of quaternions with the real parts set to 1 and the imaginary parts set to 0.

`quat0nes = ones(sz1,...,szN,'quaternion')` returns a `sz1`-by-...-by-`szN` array of ones where `sz1,...,szN` indicates the size of each dimension.

`quat0nes = ones(____, 'like', prototype, 'quaternion')` specifies the underlying class of the returned quaternion array to be the same as the underlying class of the quaternion prototype.

Examples

Quaternion Scalar One

Create a quaternion scalar one.

```
quat0nes = ones('quaternion')

quat0nes = quaternion
          1 + 0i + 0j + 0k
```

Square Matrix of Quaternion Ones

Create an n-by-n matrix of quaternion ones.

```
n = 3;
quat0nes = ones(n, 'quaternion')

quat0nes=3x3 quaternion array
    1 + 0i + 0j + 0k    1 + 0i + 0j + 0k    1 + 0i + 0j + 0k
    1 + 0i + 0j + 0k    1 + 0i + 0j + 0k    1 + 0i + 0j + 0k
    1 + 0i + 0j + 0k    1 + 0i + 0j + 0k    1 + 0i + 0j + 0k
```

Multidimensional Array of Quaternion Ones

Create a multidimensional array of quaternion ones by defining array dimensions in order. In this example, you create a 3-by-1-by-2 array. You can specify dimensions using a row vector or comma-separated integers. Specify the dimensions using a row vector and display the results:

```
dims = [3,1,2];
quat0nesSyntax1 = ones(dims, 'quaternion')
```

```
quat0nesSyntax1 = 3x1x2 quaternion array
quat0nesSyntax1(:,:,1) =
```

```
    1 + 0i + 0j + 0k
    1 + 0i + 0j + 0k
    1 + 0i + 0j + 0k
```

```
quat0nesSyntax1(:,:,2) =
```

```
    1 + 0i + 0j + 0k
    1 + 0i + 0j + 0k
    1 + 0i + 0j + 0k
```

Specify the dimensions using comma-separated integers, and then verify the equivalency of the two syntaxes:

```
quat0nesSyntax2 = ones(3,1,2, 'quaternion');
isequal(quat0nesSyntax1, quat0nesSyntax2)
```

```
ans = logical
     1
```

Underlying Class of Quaternion Ones

A quaternion is a four-part hyper-complex number used in three-dimensional rotations and orientations. You can specify the underlying data type of the parts as `single` or `double`. The default is `double`.

Create a quaternion array of ones with the underlying data type set to `single`.

```
quatOnes = ones(2,'like',single(1),'quaternion')
```

```
quatOnes=2x2 quaternion array
    1 + 0i + 0j + 0k    1 + 0i + 0j + 0k
    1 + 0i + 0j + 0k    1 + 0i + 0j + 0k
```

Verify the underlying class using the `classUnderlying` function.

```
classUnderlying(quatOnes)
```

```
ans =
'single'
```

Input Arguments

n — Size of square quaternion matrix

integer value

Size of square quaternion matrix, specified as an integer value.

If `n` is zero or negative, then `quatOnes` is returned as an empty matrix.

Example: `ones(4,'quaternion')` returns a 4-by-4 matrix of quaternions with the real parts set to 1 and the imaginary parts set to 0.

Data Types: `single` | `double` | `int8` | `int16` | `int32` | `int64` | `uint8` | `uint16` | `uint32` | `uint64`

sz — Output size

row vector of integer values

Output size, specified as a row vector of integer values. Each element of `sz` indicates the size of the corresponding dimension in `quatOnes`. If the size of any dimension is 0 or negative, then `quatOnes` is returned as an empty array.

Data Types: `single` | `double` | `int8` | `int16` | `int32` | `int64` | `uint8` | `uint16` | `uint32` | `uint64`

prototype — Quaternion prototype

variable

Quaternion prototype, specified as a variable.

Example: `ones(2,'like',quat,'quaternion')` returns a 2-by-2 matrix of quaternions with the same underlying class as the prototype quaternion, `quat`.

Data Types: `quaternion`

sz1, ..., szN — Size of each dimension

two or more integer values

Size of each dimension, specified as two or more integers. If the size of any dimension is 0 or negative, then `quatOnes` is returned as an empty array.

Example: `ones(2,3,'quaternion')` returns a 2-by-3 matrix of quaternions with the real parts set to 1 and the imaginary parts set to 0.

Data Types: `single` | `double` | `int8` | `int16` | `int32` | `int64` | `uint8` | `uint16` | `uint32` | `uint64`

Output Arguments

quat0nes – Quaternion ones

scalar | vector | matrix | multidimensional array

Quaternion ones, returned as a scalar, vector, matrix, or multidimensional array of quaternions.

Given a quaternion of the form $Q = a + bi + cj + dk$, a quaternion one is defined as $Q = 1 + 0i + 0j + 0k$.

Data Types: `quaternion`

Extended Capabilities

C/C++ Code Generation

Generate C and C++ code using MATLAB® Coder™.

See Also

Functions

`zeros`

Objects

`quaternion`

Topics

“Rotations, Orientation, and Quaternions”

Introduced in R2018b

parts

Extract quaternion parts

Syntax

```
[a,b,c,d] = parts(quat)
```

Description

`[a,b,c,d] = parts(quat)` returns the parts of the quaternion array as arrays, each the same size as `quat`.

Examples

Convert Quaternion to Matrix of Quaternion Parts

Convert a quaternion representation to parts using the `parts` function.

Create a two-element column vector of quaternions by specifying the parts.

```
quat = quaternion([1:4;5:8])
```

```
quat=2×1 quaternion array
    1 + 2i + 3j + 4k
    5 + 6i + 7j + 8k
```

Recover the parts from the quaternion matrix using the `parts` function. The parts are returned as separate output arguments, each the same size as the input 2-by-1 column vector of quaternions.

```
[qA,qB,qC,qD] = parts(quat)
```

```
qA = 2×1
```

```
    1
    5
```

```
qB = 2×1
```

```
    2
    6
```

```
qC = 2×1
```

```
    3
    7
```

```
qD = 2×1
```

4
8

Input Arguments

quat — Quaternion

scalar | vector | matrix | multidimensional array

Quaternion, specified as a quaternion or array of quaternions.

Data Types: quaternion

Output Arguments

[a, b, c, d] — Quaternion parts

scalar | vector | matrix | multidimensional array

Quaternion parts, returned as four arrays: a, b, d, and d. Each part is the same size as `quat`.

Data Types: single | double

Extended Capabilities

C/C++ Code Generation

Generate C and C++ code using MATLAB® Coder™.

See Also

Functions

classUnderlying | compact

Objects

quaternion

Topics

"Rotations, Orientation, and Quaternions"

Introduced in R2018b

power, .^

Element-wise quaternion power

Syntax

```
C = A.^b
```

Description

$C = A.^b$ raises each element of A to the corresponding power in b .

Examples

Raise a Quaternion to a Real Scalar Power

Create a quaternion and raise it to a real scalar power.

```
A = quaternion(1,2,3,4)
```

```
A = quaternion  
    1 + 2i + 3j + 4k
```

```
b = 3;  
C = A.^b
```

```
C = quaternion  
   -86 - 52i - 78j - 104k
```

Raise a Quaternion Array to Powers from a Multidimensional Array

Create a 2-by-1 quaternion array and raise it to powers from a 2-D array.

```
A = quaternion([1:4;5:8])
```

```
A=2x1 quaternion array  
    1 + 2i + 3j + 4k  
    5 + 6i + 7j + 8k
```

```
b = [1 0 2; 3 2 1]
```

```
b = 2x3
```

```
    1    0    2  
    3    2    1
```

```
C = A.^b
```

$C=2 \times 3$ quaternion array

$$\begin{array}{cccccccccccc} 1 + & 2i + & 3j + & 4k & 1 + & 0i + & 0j + & 0k & -28 + & 4i + & 6j + \\ -2110 - & 444i - & 518j - & 592k & -124 + & 60i + & 70j + & 80k & 5 + & 6i + & 7j + \end{array}$$

Input Arguments

A — Base

scalar | vector | matrix | multidimensional array

Base, specified as a scalar, vector, matrix, or multidimensional array.

Data Types: quaternion | single | double

b — Exponent

scalar | vector | matrix | multidimensional array

Exponent, specified as a real scalar, vector, matrix, or multidimensional array.

Data Types: single | double

Output Arguments

C — Result

scalar | vector | matrix | multidimensional array

Each element of quaternion A raised to the corresponding power in b , returned as a scalar, vector, matrix, or multidimensional array.

Data Types: quaternion

Algorithms

The polar representation of a quaternion $A = a + bi + cj + dk$ is given by

$$A = \|A\|(\cos\theta + \hat{u}\sin\theta)$$

where θ is the angle of rotation, and \hat{u} is the unit quaternion.

Quaternion A raised by a real exponent b is given by

$$P = A.^b = \|A\|^b(\cos(b\theta) + \hat{u}\sin(b\theta))$$

Extended Capabilities

C/C++ Code Generation

Generate C and C++ code using MATLAB® Coder™.

See Also

Functions

exp | log

Objects

quaternion

Topics

“Rotations, Orientation, and Quaternions”

Introduced in R2018b

prod

Product of a quaternion array

Syntax

```
quatProd = prod(quat)
quatProd = prod(quat,dim)
```

Description

`quatProd = prod(quat)` returns the quaternion product of the elements of the array.

`quatProd = prod(quat,dim)` calculates the quaternion product along dimension `dim`.

Examples

Product of Quaternions in Each Column

Create a 3-by-3 array whose elements correspond to their linear indices.

```
A = reshape(quaternion(randn(9,4)),3,3)
```

A=3×3 quaternion array

```
0.53767 + 2.7694i + 1.409j - 0.30344k    0.86217 + 0.7254i - 1.2075j + 0.888
1.8339 - 1.3499i + 1.4172j + 0.29387k    0.31877 - 0.063055i + 0.71724j - 1.147
-2.2588 + 3.0349i + 0.6715j - 0.78728k    -1.3077 + 0.71474i + 1.6302j - 1.068
```

Find the product of the quaternions in each column. The length of the first dimension is 1, and the length of the second dimension matches `size(A,2)`.

```
B = prod(A)
```

B=1×3 quaternion array

```
-19.837 - 9.1521i + 15.813j - 19.918k    -5.4708 - 0.28535i + 3.077j - 1.2295k
```

Product of Specified Dimension of Quaternion Array

You can specify which dimension of a quaternion array to take the product of.

Create a 2-by-2-by-2 quaternion array.

```
A = reshape(quaternion(randn(8,4)),2,2,2);
```

Find the product of the elements in each page of the array. The length of the first dimension matches `size(A,1)`, the length of the second dimension matches `size(A,2)`, and the length of the third dimension is 1.

```
dim = 3;  
B = prod(A,dim)
```

```
B=2x2 quaternion array  
-2.4847 + 1.1659i - 0.37547j + 2.8068k    0.28786 - 0.29876i - 0.51231j - 4.2972k  
0.38986 - 3.6606i - 2.0474j - 6.047k    -1.741 - 0.26782i + 5.4346j + 4.1452k
```

Input Arguments

quat — Quaternion

scalar | vector | matrix | multidimensional array

Quaternion, specified as scalar, vector, matrix, or multidimensional array of quaternions.

Example: `qProd = prod(quat)` calculates the quaternion product along the first non-singleton dimension of `quat`.

Data Types: quaternion

dim — Dimension

first non-singleton dimension (default) | positive integer

Dimension along which to calculate the quaternion product, specified as a positive integer. If `dim` is not specified, `prod` operates along the first non-singleton dimension of `quat`.

Data Types: single | double | int8 | int16 | int32 | int64 | uint8 | uint16 | uint32 | uint64

Output Arguments

quatProd — Quaternion product

positive integer

Quaternion product, returned as quaternion array with one less non-singleton dimension than `quat`.

For example, if `quat` is a 2-by-2-by-5 array,

- `prod(quat,1)` returns a 1-by-2-by-5 array.
- `prod(quat,2)` returns a 2-by-1-by-5 array.
- `prod(quat,3)` returns a 2-by-2 array.

Data Types: quaternion

Extended Capabilities

C/C++ Code Generation

Generate C and C++ code using MATLAB® Coder™.

See Also

Functions

`mtimes, *` | `times, .*`

Objects

quaternion

Topics

“Rotations, Orientation, and Quaternions”

Introduced in R2018b

rdivide, ./

Element-wise quaternion right division

Syntax

```
C = A./B
```

Description

`C = A./B` performs quaternion element-wise division by dividing each element of quaternion A by the corresponding element of quaternion B.

Examples

Divide a Quaternion Array by a Real Scalar

Create a 2-by-1 quaternion array, and divide it element-by-element by a real scalar.

```
A = quaternion([1:4;5:8])
```

```
A=2×1 quaternion array
    1 + 2i + 3j + 4k
    5 + 6i + 7j + 8k
```

```
B = 2;
C = A./B
```

```
C=2×1 quaternion array
    0.5 + 1i + 1.5j + 2k
    2.5 + 3i + 3.5j + 4k
```

Divide a Quaternion Array by Another Quaternion Array

Create a 2-by-2 quaternion array, and divide it element-by-element by another 2-by-2 quaternion array.

```
q1 = quaternion(magic(4));
A = reshape(q1,2,2)
```

```
A=2×2 quaternion array
    16 + 2i + 3j + 13k    9 + 7i + 6j + 12k
    5 + 11i + 10j + 8k   4 + 14i + 15j + 1k
```

```
q2 = quaternion([1:4;3:6;2:5;4:7]);
B = reshape(q2,2,2)
```

B=2×2 quaternion array

$$\begin{array}{cc} 1 + 2i + 3j + 4k & 2 + 3i + 4j + 5k \\ 3 + 4i + 5j + 6k & 4 + 5i + 6j + 7k \end{array}$$

C = A./B

C=2×2 quaternion array

$$\begin{array}{cccc} 2.7 - 0.1i - 2.1j - 1.7k & 2.2778 + 0.092593i - 0.46296j - 0.5740k \\ 1.8256 - 0.081395i + 0.45349j - 0.24419k & 1.4524 - 0.5i + 1.0238j - 0.261k \end{array}$$

Input Arguments

A — Dividend

scalar | vector | matrix | multidimensional array

Dividend, specified as a quaternion, an array of quaternions, a real scalar, or an array of real numbers.

A and B must have compatible sizes. In the simplest cases, they can be the same size or one can be a scalar. Two inputs have compatible sizes if, for every dimension, the dimension sizes of the inputs are the same or one of the dimensions is 1.

Data Types: quaternion | single | double

B — Divisor

scalar | vector | matrix | multidimensional array

Divisor, specified as a quaternion, an array of quaternions, a real scalar, or an array of real numbers.

A and B must have compatible sizes. In the simplest cases, they can be the same size or one can be a scalar. Two inputs have compatible sizes if, for every dimension, the dimension sizes of the inputs are the same or one of the dimensions is 1.

Data Types: quaternion | single | double

Output Arguments

C — Result

scalar | vector | matrix | multidimensional array

Result of quaternion division, returned as a scalar, vector, matrix, or multidimensional array.

Data Types: quaternion

Algorithms

Quaternion Division

Given a quaternion $A = a_1 + a_2i + a_3j + a_4k$ and a real scalar p ,

$$C = A ./ p = \frac{a_1}{p} + \frac{a_2}{p}i + \frac{a_3}{p}j + \frac{a_4}{p}k$$

Note For a real scalar p , $A./p = A.\backslash p$.

Quaternion Division by a Quaternion Scalar

Given two quaternions A and B of compatible sizes,

$$C = A ./ B = A .* B^{-1} = A .* \left(\frac{\text{conj}(B)}{\text{norm}(B)^2} \right)$$

Extended Capabilities

C/C++ Code Generation

Generate C and C++ code using MATLAB® Coder™.

See Also

Functions

`conj` | `ldivide`, `.\` | `norm` | `times`, `.*`

Objects

`quaternion`

Topics

“Rotations, Orientation, and Quaternions”

Introduced in R2018b

rotateframe

Quaternion frame rotation

Syntax

```
rotationResult = rotateframe(quat, cartesianPoints)
```

Description

`rotationResult = rotateframe(quat, cartesianPoints)` rotates the frame of reference for the Cartesian points using the quaternion, `quat`. The elements of the quaternion are normalized before use in the rotation.

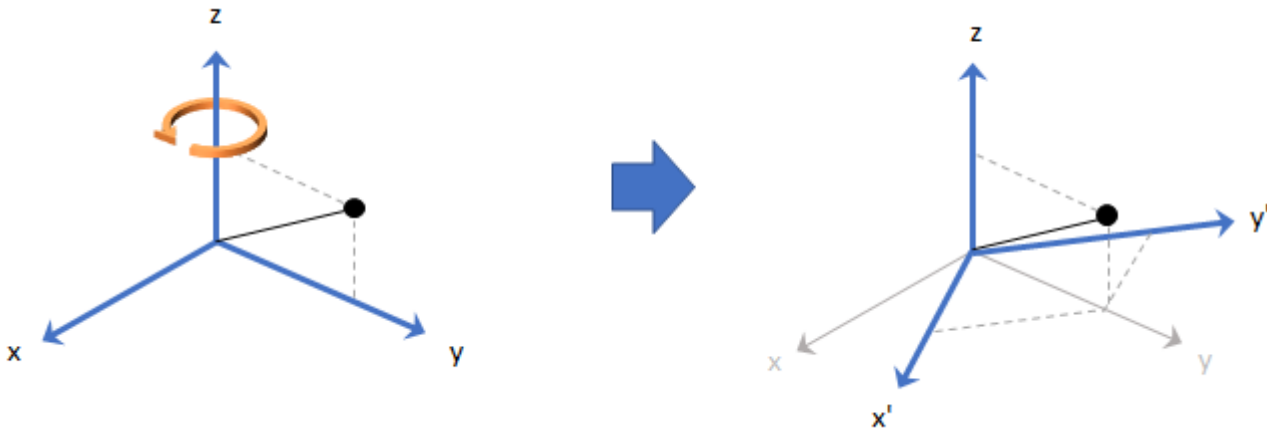

Examples

Rotate Frame Using Quaternion Vector

Define a point in three dimensions. The coordinates of a point are always specified in the order x , y , and z . For convenient visualization, define the point on the x - y plane.

```
x = 0.5;
y = 0.5;
z = 0;
plot(x,y, 'ko')
hold on
axis([-1 1 -1 1])
```

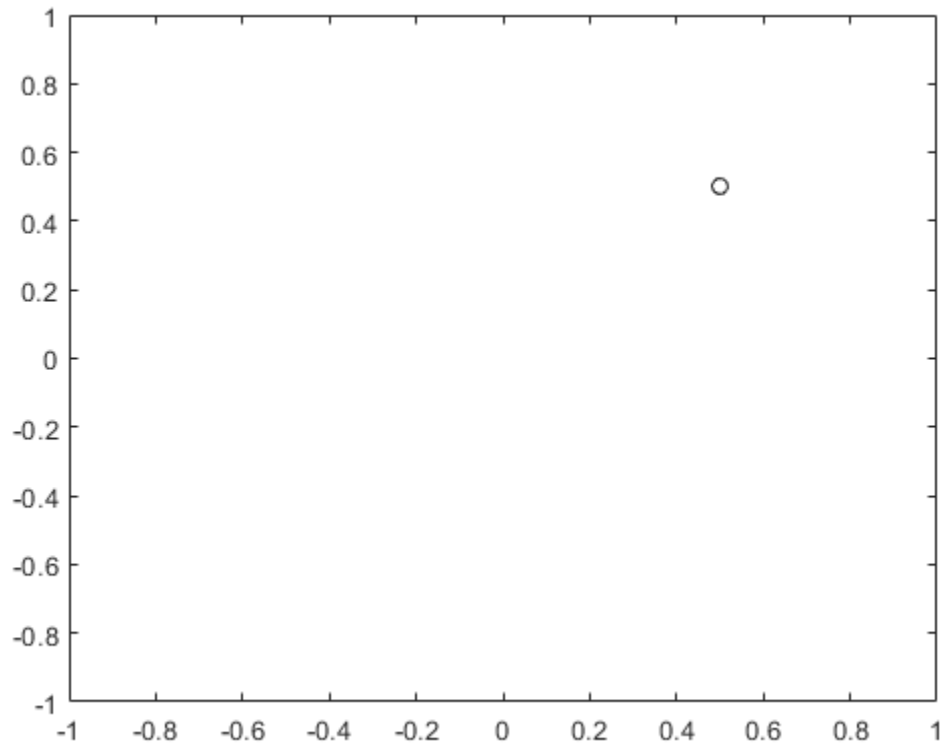

Create a quaternion vector specifying two separate rotations, one to rotate the frame 45 degrees and another to rotate the point -90 degrees about the z-axis. Use `rotateframe` to perform the rotations.

```
quat = quaternion([0,0,pi/4; ...
                  0,0,-pi/2], 'euler', 'XYZ', 'frame');
```

```
rereferencedPoint = rotateframe(quat, [x,y,z])
```

```
rereferencedPoint = 2x3
```

```
    0.7071    -0.0000         0
   -0.5000     0.5000         0
```

Plot the rereferenced points.

```
plot(rereferencedPoint(1,1),rereferencedPoint(1,2),'bo')
plot(rereferencedPoint(2,1),rereferencedPoint(2,2),'go')
```

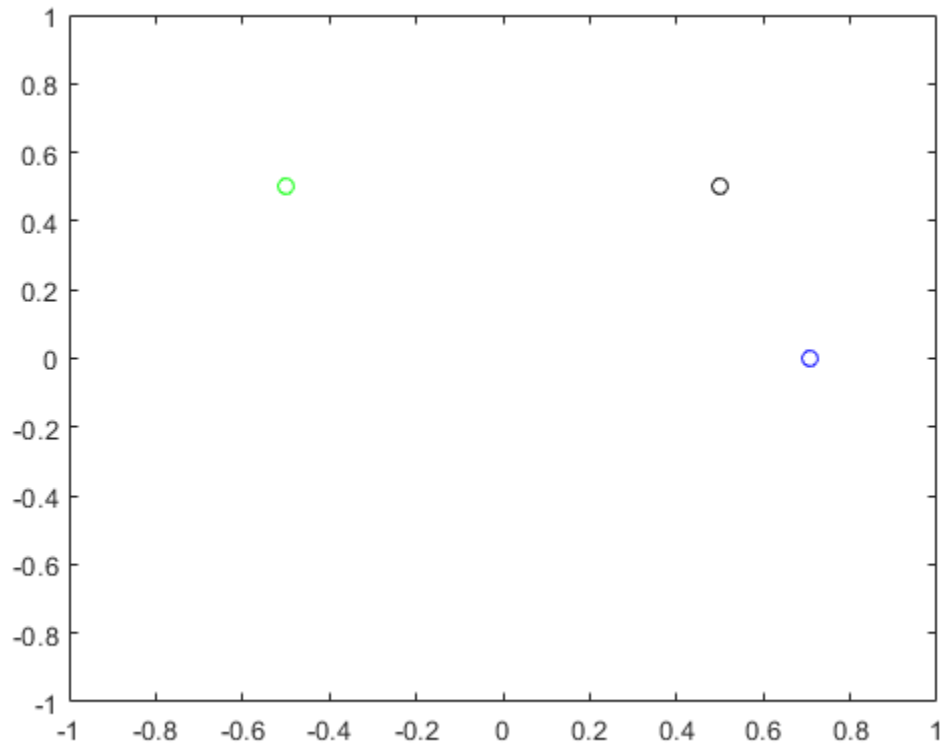

Rereference Group of Points using Quaternion

Define two points in three-dimensional space. Define a quaternion to rereference the points by first rotating the reference frame about the z-axis 30 degrees and then about the new y-axis 45 degrees.

```
a = [1,0,0];
b = [0,1,0];
quat = quaternion([30,45,0], 'eulerd', 'ZYX', 'point');
```

Use `rotateframe` to reference both points using the quaternion rotation operator. Display the result.

```
rP = rotateframe(quat, [a;b])
rP = 2x3
    0.6124    -0.3536    0.7071
    0.5000     0.8660   -0.0000
```

Visualize the original orientation and the rotated orientation of the points. Draw lines from the origin to each of the points for visualization purposes.

```
plot3(a(1),a(2),a(3), 'bo');
hold on
```

```

grid on
axis([-1 1 -1 1 -1 1])
xlabel('x')
ylabel('y')
zlabel('z')

plot3(b(1),b(2),b(3), 'ro');
plot3(rP(1,1),rP(1,2),rP(1,3), 'bd')
plot3(rP(2,1),rP(2,2),rP(2,3), 'rd')

plot3([0;rP(1,1)],[0;rP(1,2)],[0;rP(1,3)], 'k')
plot3([0;rP(2,1)],[0;rP(2,2)],[0;rP(2,3)], 'k')
plot3([0;a(1)],[0;a(2)],[0;a(3)], 'k')
plot3([0;b(1)],[0;b(2)],[0;b(3)], 'k')

```

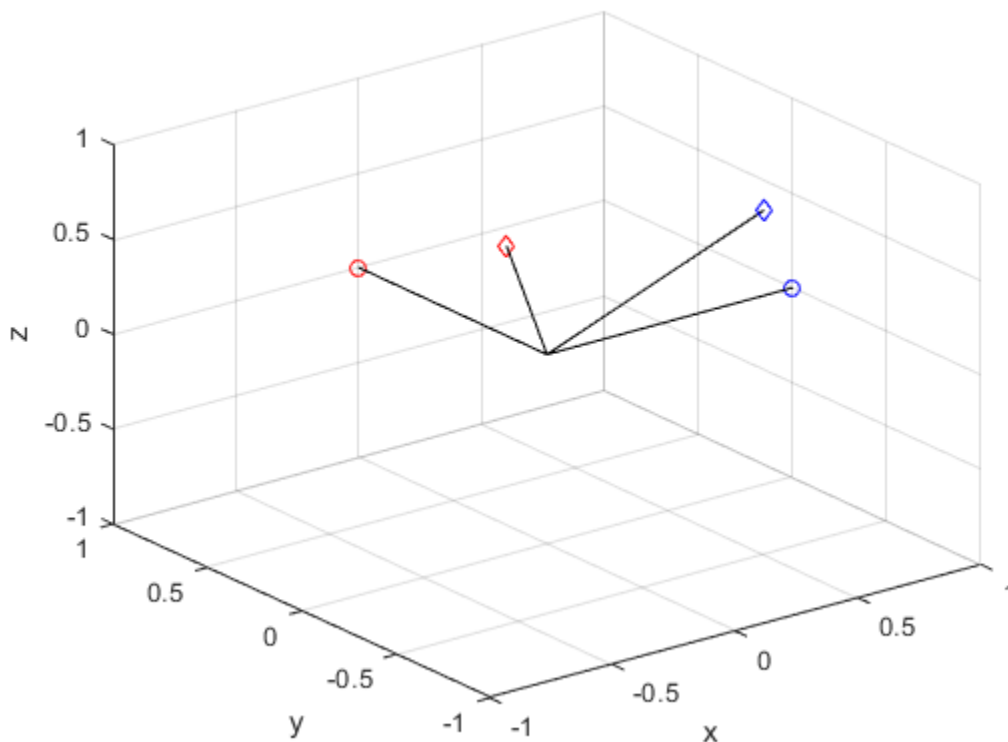

Input Arguments

quat — Quaternion that defines rotation

scalar | vector

Quaternion that defines rotation, specified as a scalar quaternion or vector of quaternions.

Data Types: quaternion

cartesianPoints — Three-dimensional Cartesian points

1-by-3 vector | N -by-3 matrix

Three-dimensional Cartesian points, specified as a 1-by-3 vector or N -by-3 matrix.

Data Types: `single` | `double`

Output Arguments

rotationResult — Re-referenced Cartesian points

vector | matrix

Cartesian points defined in reference to rotated reference frame, returned as a vector or matrix the same size as `cartesianPoints`.

The data type of the re-referenced Cartesian points is the same as the underlying data type of `quat`.

Data Types: `single` | `double`

Algorithms

Quaternion frame rotation re-references a point specified in \mathbf{R}^3 by rotating the original frame of reference according to a specified quaternion:

$$L_q(u) = q*uq$$

where q is the quaternion, $*$ represents conjugation, and u is the point to rotate, specified as a quaternion.

For convenience, the `rotateframe` function takes a point in \mathbf{R}^3 and returns a point in \mathbf{R}^3 . Given a function call with some arbitrary quaternion, $q = a + bi + cj + dk$, and arbitrary coordinate, $[x,y,z]$,

```
point = [x,y,z];
rereferencedPoint = rotateframe(q,point)
```

the `rotateframe` function performs the following operations:

- 1 Converts point $[x,y,z]$ to a quaternion:

$$u_q = 0 + xi + yj + zk$$

- 2 Normalizes the quaternion, q :

$$q_n = \frac{q}{\sqrt{a^2 + b^2 + c^2 + d^2}}$$

- 3 Applies the rotation:

$$v_q = q*u_qq$$

- 4 Converts the quaternion output, v_q , back to \mathbf{R}^3

Extended Capabilities

C/C++ Code Generation

Generate C and C++ code using MATLAB® Coder™.

See Also

Functions

rotatepoint

Objects

quaternion

Topics

“Rotations, Orientation, and Quaternions”

Introduced in R2018b

rotatepoint

Quaternion point rotation

Syntax

```
rotationResult = rotatepoint(quat, cartesianPoints)
```

Description

`rotationResult = rotatepoint(quat, cartesianPoints)` rotates the Cartesian points using the quaternion, `quat`. The elements of the quaternion are normalized before use in the rotation.

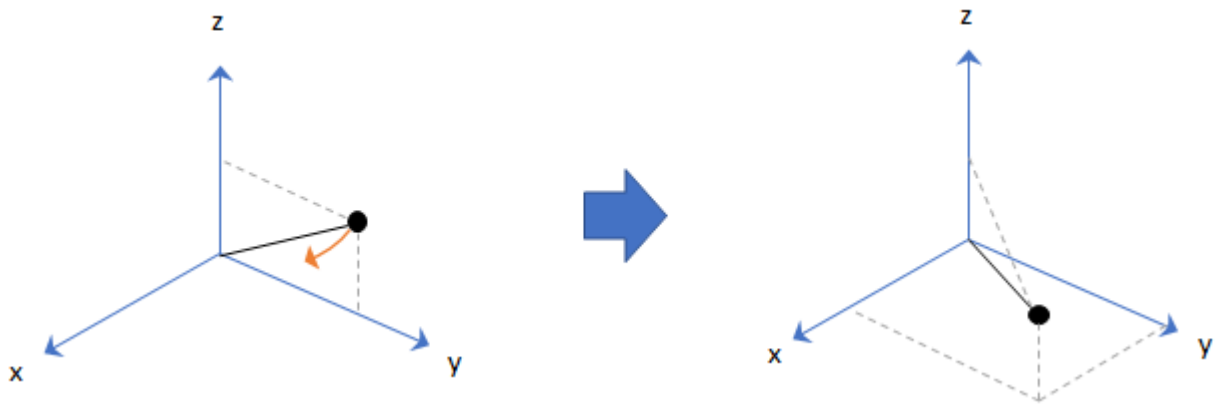

Examples

Rotate Point Using Quaternion Vector

Define a point in three dimensions. The coordinates of a point are always specified in order `x`, `y`, `z`. For convenient visualization, define the point on the `x-y` plane.

```
x = 0.5;  
y = 0.5;  
z = 0;  
  
plot(x,y, 'ko')  
hold on  
axis([-1 1 -1 1])
```

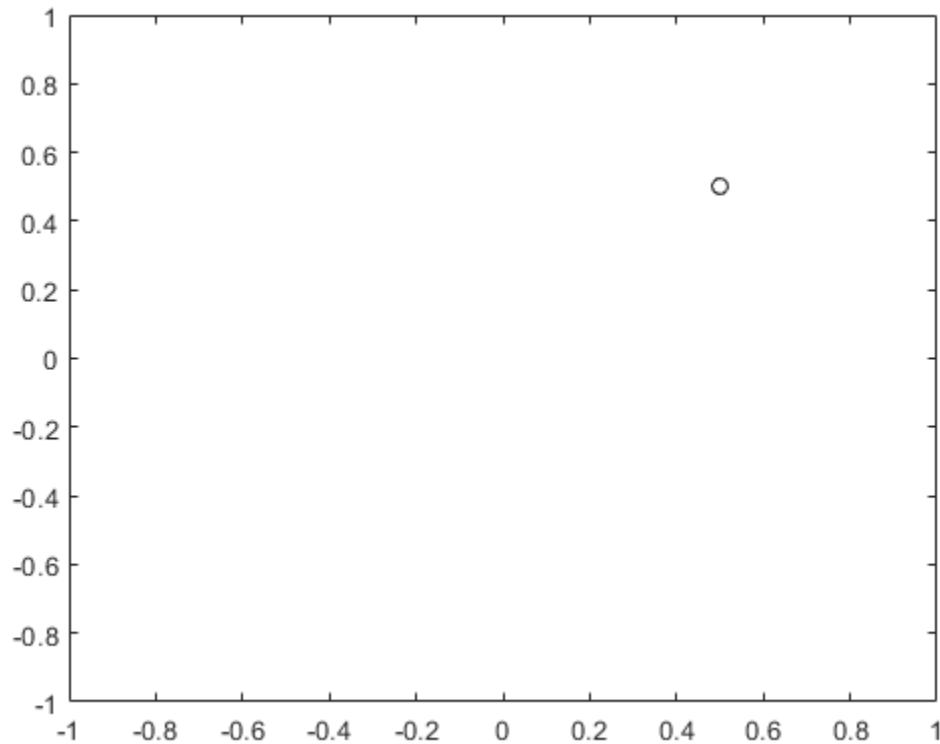

Create a quaternion vector specifying two separate rotations, one to rotate the point 45 and another to rotate the point -90 degrees about the z-axis. Use `rotatepoint` to perform the rotation.

```
quat = quaternion([0,0,pi/4; ...
                  0,0,-pi/2], 'euler', 'XYZ', 'point');
```

```
rotatedPoint = rotatepoint(quat,[x,y,z])
```

```
rotatedPoint = 2x3
```

```
-0.0000    0.7071    0
 0.5000   -0.5000    0
```

Plot the rotated points.

```
plot(rotatedPoint(1,1),rotatedPoint(1,2), 'bo')
plot(rotatedPoint(2,1),rotatedPoint(2,2), 'go')
```

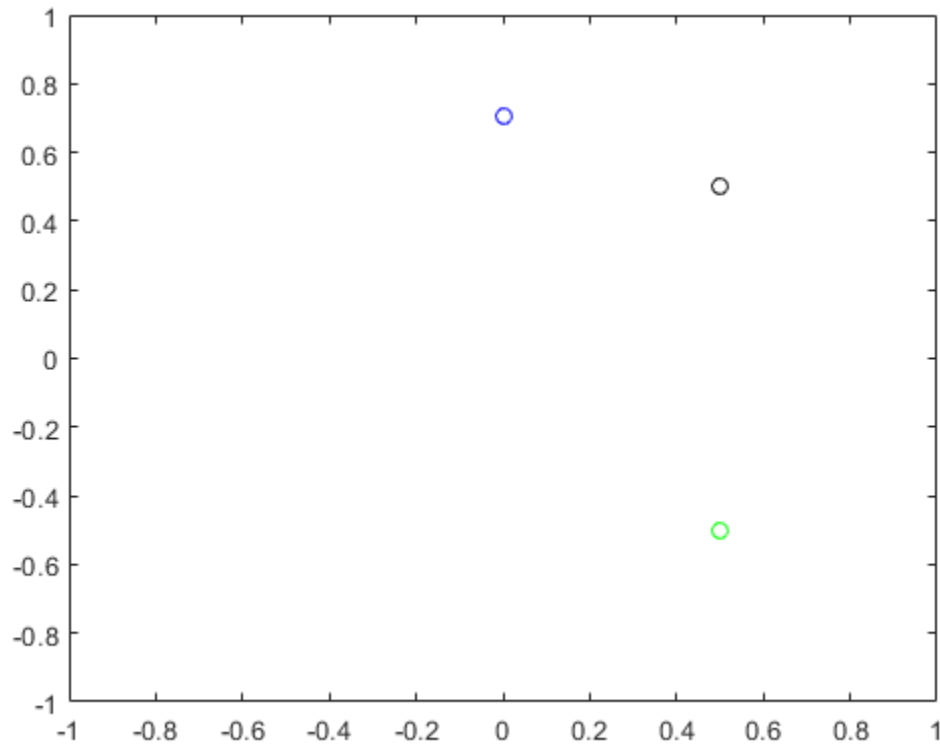

Rotate Group of Points Using Quaternion

Define two points in three-dimensional space. Define a quaternion to rotate the point by first rotating about the z-axis 30 degrees and then about the new y-axis 45 degrees.

```
a = [1,0,0];
b = [0,1,0];
quat = quaternion([30,45,0], 'eulerd', 'ZYX', 'point');
```

Use rotatepoint to rotate both points using the quaternion rotation operator. Display the result.

```
rP = rotatepoint(quat,[a;b])
rP = 2×3
    0.6124    0.5000   -0.6124
   -0.3536    0.8660    0.3536
```

Visualize the original orientation and the rotated orientation of the points. Draw lines from the origin to each of the points for visualization purposes.

```
plot3(a(1),a(2),a(3), 'bo');
hold on
```

```

grid on
axis([-1 1 -1 1 -1 1])
xlabel('x')
ylabel('y')
zlabel('z')

plot3(b(1),b(2),b(3), 'ro');
plot3(rP(1,1),rP(1,2),rP(1,3), 'bd')
plot3(rP(2,1),rP(2,2),rP(2,3), 'rd')

plot3([0;rP(1,1)],[0;rP(1,2)],[0;rP(1,3)], 'k')
plot3([0;rP(2,1)],[0;rP(2,2)],[0;rP(2,3)], 'k')
plot3([0;a(1)],[0;a(2)],[0;a(3)], 'k')
plot3([0;b(1)],[0;b(2)],[0;b(3)], 'k')

```

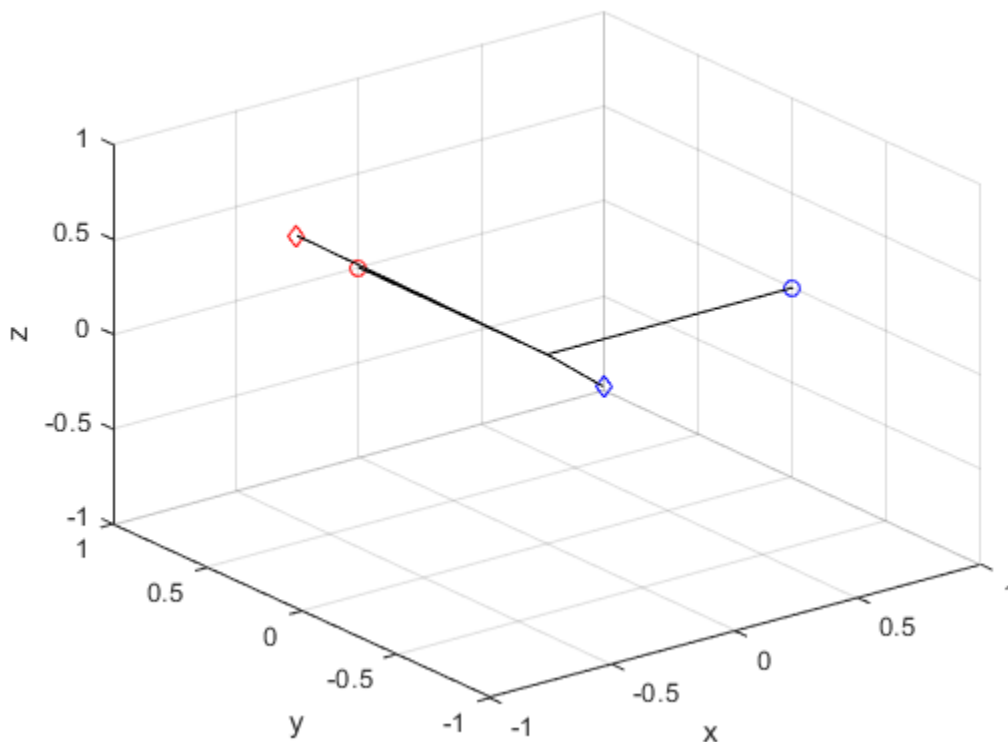

Input Arguments

quat — Quaternion that defines rotation

scalar | vector

Quaternion that defines rotation, specified as a scalar quaternion, row vector of quaternions, or column vector of quaternions.

Data Types: quaternion

cartesianPoints — Three-dimensional Cartesian points1-by-3 vector | N -by-3 matrix

Three-dimensional Cartesian points, specified as a 1-by-3 vector or N -by-3 matrix.

Data Types: `single` | `double`

Output Arguments**rotationResult — Repositioned Cartesian points**

vector | matrix

Rotated Cartesian points defined using the quaternion rotation, returned as a vector or matrix the same size as `cartesianPoints`.

Data Types: `single` | `double`

Algorithms

Quaternion point rotation rotates a point specified in \mathbf{R}^3 according to a specified quaternion:

$$L_q(u) = quq^*$$

where q is the quaternion, $*$ represents conjugation, and u is the point to rotate, specified as a quaternion.

For convenience, the `rotatepoint` function takes in a point in \mathbf{R}^3 and returns a point in \mathbf{R}^3 . Given a function call with some arbitrary quaternion, $q = a + bi + cj + dk$, and arbitrary coordinate, $[x,y,z]$, for example,

```
rereferencedPoint = rotatepoint(q,[x,y,z])
```

the `rotatepoint` function performs the following operations:

- 1 Converts point $[x,y,z]$ to a quaternion:

$$u_q = 0 + xi + yj + zk$$

- 2 Normalizes the quaternion, q :

$$q_n = \frac{q}{\sqrt{a^2 + b^2 + c^2 + d^2}}$$

- 3 Applies the rotation:

$$v_q = qu_qq^*$$

- 4 Converts the quaternion output, v_q , back to \mathbf{R}^3

Extended Capabilities**C/C++ Code Generation**

Generate C and C++ code using MATLAB® Coder™.

See Also

Functions

rotateframe

Objects

quaternion

Topics

“Rotations, Orientation, and Quaternions”

Introduced in R2018b

rotmat

Convert quaternion to rotation matrix

Syntax

```
rotationMatrix = rotmat(quat,rotationType)
```

Description

`rotationMatrix = rotmat(quat,rotationType)` converts the quaternion, `quat`, to an equivalent rotation matrix representation.

Examples

Convert Quaternion to Rotation Matrix for Point Rotation

Define a quaternion for use in point rotation.

```
theta = 45;
gamma = 30;
quat = quaternion([0,theta,gamma], 'eulerd', 'ZYX', 'point')

quat = quaternion
      0.8924 + 0.23912i + 0.36964j + 0.099046k
```

Convert the quaternion to a rotation matrix.

```
rotationMatrix = rotmat(quat, 'point')

rotationMatrix = 3×3

    0.7071    -0.0000    0.7071
    0.3536     0.8660   -0.3536
   -0.6124     0.5000     0.6124
```

To verify the rotation matrix, directly create two rotation matrices corresponding to the rotations about the *y*- and *x*-axes. Multiply the rotation matrices and compare to the output of `rotmat`.

```
theta = 45;
gamma = 30;

ry = [cosd(theta)  0          sind(theta) ; ...
      0            1          0           ; ...
      -sind(theta) 0          cosd(theta)];

rx = [1           0          0          ; ...
      0           cosd(gamma) -sind(gamma) ; ...
      0           sind(gamma) cosd(gamma)];

rotationMatrixVerification = rx*ry
```

```
rotationMatrixVerification = 3×3

    0.7071         0    0.7071
    0.3536    0.8660   -0.3536
   -0.6124    0.5000    0.6124
```

Convert Quaternion to Rotation Matrix for Frame Rotation

Define a quaternion for use in frame rotation.

```
theta = 45;
gamma = 30;
quat = quaternion([0,theta,gamma], 'eulerd', 'ZYX', 'frame')

quat = quaternion
    0.8924 + 0.23912i + 0.36964j - 0.099046k
```

Convert the quaternion to a rotation matrix.

```
rotationMatrix = rotmat(quat, 'frame')

rotationMatrix = 3×3

    0.7071   -0.0000   -0.7071
    0.3536    0.8660    0.3536
    0.6124   -0.5000    0.6124
```

To verify the rotation matrix, directly create two rotation matrices corresponding to the rotations about the y- and x-axes. Multiply the rotation matrices and compare to the output of rotmat.

```
theta = 45;
gamma = 30;

ry = [cosd(theta)  0          -sind(theta) ; ...
      0            1           0          ; ...
      sind(theta)  0           cosd(theta)];

rx = [1           0           0           ; ...
      0           cosd(gamma) sind(gamma) ; ...
      0           -sind(gamma) cosd(gamma)];

rotationMatrixVerification = rx*ry

rotationMatrixVerification = 3×3

    0.7071         0   -0.7071
    0.3536    0.8660    0.3536
    0.6124   -0.5000    0.6124
```

Convert Quaternion Vector to Rotation Matrices

Create a 3-by-1 normalized quaternion vector.

```
qVec = normalize( quaternion( randn(3,4) ) );
```

Convert the quaternion array to rotation matrices. The pages of `rotmatArray` correspond to the linear index of `qVec`.

```
rotmatArray = rotmat( qVec, 'frame' );
```

Assume `qVec` and `rotmatArray` correspond to a sequence of rotations. Combine the quaternion rotations into a single representation, then apply the quaternion rotation to arbitrarily initialized Cartesian points.

```
loc = normalize( randn(1,3) );
quat = prod( qVec );
rotateframe( quat, loc)
```

```
ans = 1×3
```

```
    0.9524    0.5297    0.9013
```

Combine the rotation matrices into a single representation, then apply the rotation matrix to the same initial Cartesian points. Verify the quaternion rotation and rotation matrix result in the same orientation.

```
totalRotMat = eye(3);
for i = 1:size( rotmatArray, 3 )
    totalRotMat = rotmatArray( :, :, i ) * totalRotMat;
end
totalRotMat * loc'
```

```
ans = 3×1
```

```
    0.9524
    0.5297
    0.9013
```

Input Arguments

quat — Quaternion to convert

scalar | vector | matrix | multidimensional array

Quaternion to convert, specified as a scalar, vector, matrix, or multidimensional array.

Data Types: quaternion

rotationType — Type or rotation

'frame' | 'point'

Type of rotation represented by the `rotationMatrix` output, specified as 'frame' or 'point'.

Data Types: char | string

Output Arguments

rotationMatrix — Rotation matrix representation

3-by-3 matrix | 3-by-3-by-*N* multidimensional array

Rotation matrix representation, returned as a 3-by-3 matrix or 3-by-3-by-*N* multidimensional array.

- If `quat` is a scalar, `rotationMatrix` is returned as a 3-by-3 matrix.
- If `quat` is non-scalar, `rotationMatrix` is returned as a 3-by-3-by-*N* multidimensional array, where `rotationMatrix(:, :, i)` is the rotation matrix corresponding to `quat(i)`.

The data type of the rotation matrix is the same as the underlying data type of `quat`.

Data Types: `single` | `double`

Algorithms

Given a quaternion of the form

$$q = a + bi + cj + dk,$$

the equivalent rotation matrix for frame rotation is defined as

$$\begin{bmatrix} 2a^2 - 1 + 2b^2 & 2bc + 2ad & 2bd - 2ac \\ 2bc - 2ad & 2a^2 - 1 + 2c^2 & 2cd + 2ab \\ 2bd + 2ac & 2cd - 2ab & 2a^2 - 1 + 2d^2 \end{bmatrix}.$$

The equivalent rotation matrix for point rotation is the transpose of the frame rotation matrix:

$$\begin{bmatrix} 2a^2 - 1 + 2b^2 & 2bc - 2ad & 2bd + 2ac \\ 2bc + 2ad & 2a^2 - 1 + 2c^2 & 2cd - 2ab \\ 2bd - 2ac & 2cd + 2ab & 2a^2 - 1 + 2d^2 \end{bmatrix}.$$

References

- [1] Kuipers, Jack B. *Quaternions and Rotation Sequences: A Primer with Applications to Orbits, Aerospace, and Virtual Reality*. Princeton, NJ: Princeton University Press, 2007.

Extended Capabilities

C/C++ Code Generation

Generate C and C++ code using MATLAB® Coder™.

See Also

Functions

`euler` | `eulerd` | `rotvec` | `rotvecd`

Objects

`quaternion`

Topics

“Rotations, Orientation, and Quaternions”

Introduced in R2018b

rotvec

Convert quaternion to rotation vector (radians)

Syntax

```
rotationVector = rotvec(quat)
```

Description

`rotationVector = rotvec(quat)` converts the quaternion array, `quat`, to an N -by-3 matrix of equivalent rotation vectors in radians. The elements of `quat` are normalized before conversion.

Examples

Convert Quaternion to Rotation Vector in Radians

Convert a random quaternion scalar to a rotation vector in radians

```
quat = quaternion(randn(1,4));  
rotvec(quat)
```

```
ans = 1×3
```

```
    1.6866   -2.0774    0.7929
```

Input Arguments

quat — Quaternion to convert

scalar | vector | matrix | multidimensional array

Quaternion to convert, specified as scalar quaternion, vector, matrix, or multidimensional array of quaternions.

Data Types: quaternion

Output Arguments

rotationVector — Rotation vector (radians)

N -by-3 matrix

Rotation vector representation, returned as an N -by-3 matrix of rotations vectors, where each row represents the [X Y Z] angles of the rotation vectors in radians. The i th row of `rotationVector` corresponds to the element `quat(i)`.

The data type of the rotation vector is the same as the underlying data type of `quat`.

Data Types: single | double

Algorithms

All rotations in 3-D can be represented by a three-element axis of rotation and a rotation angle, for a total of four elements. If the rotation axis is constrained to be unit length, the rotation angle can be distributed over the vector elements to reduce the representation to three elements.

Recall that a quaternion can be represented in axis-angle form

$$q = \cos(\theta/2) + \sin(\theta/2)(xi + yj + zk),$$

where θ is the angle of rotation and $[x,y,z]$ represent the axis of rotation.

Given a quaternion of the form

$$q = a + bi + cj + dk,$$

you can solve for the rotation angle using the axis-angle form of quaternions:

$$\theta = 2\cos^{-1}(a).$$

Assuming a normalized axis, you can rewrite the quaternion as a rotation vector without loss of information by distributing θ over the parts b , c , and d . The rotation vector representation of q is

$$q_{rv} = \frac{\theta}{\sin(\theta/2)}[b, c, d].$$

Extended Capabilities

C/C++ Code Generation

Generate C and C++ code using MATLAB® Coder™.

See Also

Functions

euler | eulerd | rotvecd

Objects

quaternion

Topics

“Rotations, Orientation, and Quaternions”

Introduced in R2018b

times, .*

Element-wise quaternion multiplication

Syntax

```
quatC = A.*B
```

Description

`quatC = A.*B` returns the element-by-element quaternion multiplication of quaternion arrays.

You can use quaternion multiplication to compose rotation operators:

- To compose a sequence of frame rotations, multiply the quaternions in the same order as the desired sequence of rotations. For example, to apply a p quaternion followed by a q quaternion, multiply in the order pq . The rotation operator becomes $(pq)^*v(pq)$, where v represents the object to rotate in quaternion form. `*` represents conjugation.
- To compose a sequence of point rotations, multiply the quaternions in the reverse order of the desired sequence of rotations. For example, to apply a p quaternion followed by a q quaternion, multiply in the reverse order, qp . The rotation operator becomes $(qp)v(qp)^*$.

Examples

Multiply Two Quaternion Vectors

Create two vectors, A and B, and multiply them element by element.

```
A = quaternion([1:4;5:8]);
B = A;
C = A.*B
```

```
C=2x1 quaternion array
    -28 + 4i + 6j + 8k
   -124 + 60i + 70j + 80k
```

Multiply Two Quaternion Arrays

Create two 3-by-3 arrays, A and B, and multiply them element by element.

```
A = reshape(quaternion(randn(9,4)),3,3);
B = reshape(quaternion(randn(9,4)),3,3);
C = A.*B
```

```
C=3x3 quaternion array
    0.60169 + 2.4332i - 2.5844j + 0.51646k   -0.49513 + 1.1722i + 4.4401j - 1.217k
   -4.2329 + 2.4547i + 3.7768j + 0.77484k   -0.65232 - 0.43112i - 1.4645j - 0.90073k
```



```
-4.4159 + 2.1926i + 1.9037j - 4.0303k -2.0232 + 0.4205i - 0.17288j + 3.8529k -2.0232 + 0.4205i - 0.17288j + 3.8529k
```

Note that quaternion multiplication is not commutative:

```
isequal(C,B.*A)
```

```
ans = logical
      0
```

Multiply Quaternion Row and Column Vectors

Create a row vector **a** and a column vector **b**, then multiply them. The 1-by-3 row vector and 4-by-1 column vector combine to produce a 4-by-3 matrix with all combinations of elements multiplied.

```
a = [zeros('quaternion'),ones('quaternion'),quaternion(randn(1,4))]
```

```
a=1x3 quaternion array
      0 +      0i +      0j +      0k      1 +      0i +      0j +      0k      0
```

```
b = quaternion(randn(4,4))
```

```
b=4x1 quaternion array
      0.31877 +      3.5784i +      0.7254j -      0.12414k
      -1.3077 +      2.7694i -      0.063055j +      1.4897k
      -0.43359 -      1.3499i +      0.71474j +      1.409k
      0.34262 +      3.0349i -      0.20497j +      1.4172k
```

```
a.*b
```

```
ans=4x3 quaternion array
      0 +      0i +      0j +      0k      0.31877 +      3.5784i +      0.7254j -      0.12414k
      0 +      0i +      0j +      0k      -1.3077 +      2.7694i -      0.063055j +      1.4897k
      0 +      0i +      0j +      0k      -0.43359 -      1.3499i +      0.71474j +      1.409k
      0 +      0i +      0j +      0k      0.34262 +      3.0349i -      0.20497j +      1.4172k
```

Input Arguments

A — Array to multiply

scalar | vector | matrix | multidimensional array

Array to multiply, specified as a quaternion, an array of quaternions, a real scalar, or an array of real numbers.

A and B must have compatible sizes. In the simplest cases, they can be the same size or one can be a scalar. Two inputs have compatible sizes if, for every dimension, the dimension sizes of the inputs are the same or one of them is 1.

Data Types: quaternion | single | double

B – Array to multiply

scalar | vector | matrix | multidimensional array

Array to multiply, specified as a quaternion, an array of quaternions, a real scalar, or an array of real numbers.

A and B must have compatible sizes. In the simplest cases, they can be the same size or one can be a scalar. Two inputs have compatible sizes if, for every dimension, the dimension sizes of the inputs are the same or one of them is 1.

Data Types: quaternion | single | double

Output Arguments

quatC – Quaternion product

scalar | vector | matrix | multidimensional array

Quaternion product, returned as a scalar, vector, matrix, or multidimensional array.

Data Types: quaternion

Algorithms

Quaternion Multiplication by a Real Scalar

Given a quaternion,

$$q = a_q + b_q i + c_q j + d_q k,$$

the product of q and a real scalar β is

$$\beta q = \beta a_q + \beta b_q i + \beta c_q j + \beta d_q k$$

Quaternion Multiplication by a Quaternion Scalar

The definition of the basis elements for quaternions,

$$i^2 = j^2 = k^2 = ijk = -1,$$

can be expanded to populate a table summarizing quaternion basis element multiplication:

	1	i	j	k
1	1	i	j	k
i	i	-1	k	-j
j	j	-k	-1	i
k	k	j	-i	-1

When reading the table, the rows are read first, for example: $ij = k$ and $ji = -k$.

Given two quaternions, $q = a_q + b_q i + c_q j + d_q k$, and $p = a_p + b_p i + c_p j + d_p k$, the multiplication can be expanded as:

$$\begin{aligned}
 z = pq &= (a_p + b_p i + c_p j + d_p k)(a_q + b_q i + c_q j + d_q k) \\
 &= a_p a_q + a_p b_q i + a_p c_q j + a_p d_q k \\
 &\quad + b_p a_q i + b_p b_q i^2 + b_p c_q j + b_p d_q i k \\
 &\quad + c_p a_q j + c_p b_q j i + c_p c_q j^2 + c_p d_q j k \\
 &\quad + d_p a_q k + d_p b_q k i + d_p c_q k j + d_p d_q k^2
 \end{aligned}$$

You can simplify the equation using the quaternion multiplication table.

$$\begin{aligned}
 z = pq &= a_p a_q + a_p b_q i + a_p c_q j + a_p d_q k \\
 &\quad + b_p a_q i - b_p b_q + b_p c_q k - b_p d_q j \\
 &\quad + c_p a_q j - c_p b_q k - c_p c_q + c_p d_q i \\
 &\quad + d_p a_q k + d_p b_q j - d_p c_q i - d_p d_q
 \end{aligned}$$

References

- [1] Kuipers, Jack B. *Quaternions and Rotation Sequences: A Primer with Applications to Orbits, Aerospace, and Virtual Reality*. Princeton, NJ: Princeton University Press, 2007.

Extended Capabilities

C/C++ Code Generation

Generate C and C++ code using MATLAB® Coder™.

See Also

Functions

mtimes, * | prod

Objects

quaternion

Topics

“Rotations, Orientation, and Quaternions”

Introduced in R2018b

transpose, .'

Transpose a quaternion array

Syntax

`Y = quat.'`

Description

`Y = quat.'` returns the non-conjugate transpose of the quaternion array, `quat`.

Examples

Vector Transpose

Create a vector of quaternions and compute its nonconjugate transpose.

```
quat = quaternion(randn(4,4))
```

```
quat=4×1 quaternion array
    0.53767 + 0.31877i + 3.5784j + 0.7254k
    1.8339 - 1.3077i + 2.7694j - 0.063055k
   -2.2588 - 0.43359i - 1.3499j + 0.71474k
    0.86217 + 0.34262i + 3.0349j - 0.20497k
```

```
quatTransposed = quat.'
```

```
quatTransposed=1×4 quaternion array
    0.53767 + 0.31877i + 3.5784j + 0.7254k    1.8339 - 1.3077i + 2.7694j - 0.063055k
```

Matrix Transpose

Create a matrix of quaternions and compute its nonconjugate transpose.

```
quat = [quaternion(randn(2,4)), quaternion(randn(2,4))]
```

```
quat=2×2 quaternion array
    0.53767 - 2.2588i + 0.31877j - 0.43359k    3.5784 - 1.3499i + 0.7254j + 0.71474k
    1.8339 + 0.86217i - 1.3077j + 0.34262k    2.7694 + 3.0349i - 0.063055j - 0.20497k
```

```
quatTransposed = quat.'
```

```
quatTransposed=2×2 quaternion array
    0.53767 - 2.2588i + 0.31877j - 0.43359k    1.8339 + 0.86217i - 1.3077j + 0.34262k
    3.5784 - 1.3499i + 0.7254j + 0.71474k    2.7694 + 3.0349i - 0.063055j - 0.20497k
```

Input Arguments

quat — Quaternion array to transpose

vector | matrix

Quaternion array to transpose, specified as a vector or matrix of quaternions. `transpose` is defined for 1-D and 2-D arrays. For higher-order arrays, use `permute`.

Data Types: quaternion

Output Arguments

Y — Transposed quaternion array

vector | matrix

Transposed quaternion array, returned as an N -by- M array, where `quat` was specified as an M -by- N array.

Extended Capabilities

C/C++ Code Generation

Generate C and C++ code using MATLAB® Coder™.

See Also

Functions

`ctranspose`, '

Objects

quaternion

Topics

“Rotations, Orientation, and Quaternions”

Introduced in R2018b

uminus, -

Quaternion unary minus

Syntax

```
mQuat = -quat
```

Description

mQuat = -quat negates the elements of quat and stores the result in mQuat.

Examples

Negate Elements of Quaternion Matrix

Unary minus negates each part of a the quaternion. Create a 2-by-2 matrix, Q.

```
Q = quaternion(randn(2),randn(2),randn(2),randn(2))
```

```
Q=2x2 quaternion array
```

```
    0.53767 + 0.31877i + 3.5784j + 0.7254k    -2.2588 - 0.43359i - 1.3499j + 0.7147k  
    1.8339 - 1.3077i + 2.7694j - 0.063055k    0.86217 + 0.34262i + 3.0349j - 0.2049k
```

Negate the parts of each quaternion in Q.

```
R = -Q
```

```
R=2x2 quaternion array
```

```
   -0.53767 - 0.31877i - 3.5784j - 0.7254k     2.2588 + 0.43359i + 1.3499j - 0.7147k  
   -1.8339 + 1.3077i - 2.7694j + 0.063055k   -0.86217 - 0.34262i - 3.0349j + 0.2049k
```

Input Arguments

quat — Quaternion array

scalar | vector | matrix | multidimensional array

Quaternion array, specified as a scalar, vector, matrix, or multidimensional array.

Data Types: quaternion

Output Arguments

mQuat — Negated quaternion array

scalar | vector | matrix | multidimensional array

Negated quaternion array, returned as the same size as quat.

Data Types: quaternion

Extended Capabilities

C/C++ Code Generation

Generate C and C++ code using MATLAB® Coder™.

See Also

Functions

minus, -

Objects

quaternion

Topics

“Rotations, Orientation, and Quaternions”

Introduced in R2018b

zeros

Create quaternion array with all parts set to zero

Syntax

```
quatZeros = zeros('quaternion')
quatZeros = zeros(n,'quaternion')
quatZeros = zeros(sz,'quaternion')
quatZeros = zeros(sz1,...,szN,'quaternion')

quatZeros = zeros( ____, 'like', prototype, 'quaternion')
```

Description

`quatZeros = zeros('quaternion')` returns a scalar quaternion with all parts set to zero.

`quatZeros = zeros(n,'quaternion')` returns an n-by-n matrix of quaternions.

`quatZeros = zeros(sz,'quaternion')` returns an array of quaternions where the size vector, `sz`, defines `size(quatZeros)`.

`quatZeros = zeros(sz1,...,szN,'quaternion')` returns a `sz1`-by-...-by-`szN` array of quaternions where `sz1`, ..., `szN` indicates the size of each dimension.

`quatZeros = zeros(____, 'like', prototype, 'quaternion')` specifies the underlying class of the returned quaternion array to be the same as the underlying class of the quaternion prototype.

Examples

Quaternion Scalar Zero

Create a quaternion scalar zero.

```
quatZeros = zeros('quaternion')

quatZeros = quaternion
           0 + 0i + 0j + 0k
```

Square Matrix of Quaternions

Create an n-by-n array of quaternion zeros.

```
n = 3;
quatZeros = zeros(n,'quaternion')

quatZeros=3x3 quaternion array
           0 + 0i + 0j + 0k           0 + 0i + 0j + 0k           0 + 0i + 0j + 0k
```



```

0 + 0i + 0j + 0k    0 + 0i + 0j + 0k    0 + 0i + 0j + 0k
0 + 0i + 0j + 0k    0 + 0i + 0j + 0k    0 + 0i + 0j + 0k

```

Multidimensional Array of Quaternion Zeros

Create a multidimensional array of quaternion zeros by defining array dimensions in order. In this example, you create a 3-by-1-by-2 array. You can specify dimensions using a row vector or comma-separated integers.

Specify the dimensions using a row vector and display the results:

```

dims = [3,1,2];
quatZerosSyntax1 = zeros(dims, 'quaternion')

```

```

quatZerosSyntax1 = 3x1x2 quaternion array
quatZerosSyntax1(:,:,1) =

```

```

0 + 0i + 0j + 0k
0 + 0i + 0j + 0k
0 + 0i + 0j + 0k

```

```

quatZerosSyntax1(:,:,2) =

```

```

0 + 0i + 0j + 0k
0 + 0i + 0j + 0k
0 + 0i + 0j + 0k

```

Specify the dimensions using comma-separated integers, and then verify the equivalence of the two syntaxes:

```

quatZerosSyntax2 = zeros(3,1,2, 'quaternion');
isequal(quatZerosSyntax1, quatZerosSyntax2)

```

```

ans = logical
     1

```

Underlying Class of Quaternion Zeros

A quaternion is a four-part hyper-complex number used in three-dimensional representations. You can specify the underlying data type of the parts as `single` or `double`. The default is `double`.

Create a quaternion array of zeros with the underlying data type set to `single`.

```

quatZeros = zeros(2, 'like', single(1), 'quaternion')

```

```

quatZeros=2x2 quaternion array
0 + 0i + 0j + 0k    0 + 0i + 0j + 0k
0 + 0i + 0j + 0k    0 + 0i + 0j + 0k

```

Verify the underlying class using the `classUnderlying` function.

```
classUnderlying(quatZeros)

ans =
'single'
```

Input Arguments

n — Size of square quaternion matrix

integer value

Size of square quaternion matrix, specified as an integer value. If `n` is 0 or negative, then `quatZeros` is returned as an empty matrix.

Example: `zeros(4, 'quaternion')` returns a 4-by-4 matrix of quaternion zeros.

Data Types: `single` | `double` | `int8` | `int16` | `int32` | `int64` | `uint8` | `uint16` | `uint32` | `uint64`

sz — Output size

row vector of integer values

Output size, specified as a row vector of integer values. Each element of `sz` indicates the size of the corresponding dimension in `quatZeros`. If the size of any dimension is 0 or negative, then `quatZeros` is returned as an empty array.

Example: `zeros([1,4,2], 'quaternion')` returns a 1-by-4-by-2 array of quaternion zeros.

Data Types: `single` | `double` | `int8` | `int16` | `int32` | `int64` | `uint8` | `uint16` | `uint32` | `uint64`

prototype — Quaternion prototype

variable

Quaternion prototype, specified as a variable.

Example: `zeros(2, 'like', quat, 'quaternion')` returns a 2-by-2 matrix of quaternions with the same underlying class as the prototype quaternion, `quat`.

Data Types: `quaternion`

sz1, ..., szN — Size of each dimension

two or more integer values

Size of each dimension, specified as two or more integers.

- If the size of any dimension is 0, then `quatZeros` is returned as an empty array.
- If the size of any dimension is negative, then it is treated as 0.

Example: `zeros(2,3, 'quaternion')` returns a 2-by-3 matrix of quaternion zeros.

Data Types: `single` | `double` | `int8` | `int16` | `int32` | `int64` | `uint8` | `uint16` | `uint32` | `uint64`

Output Arguments

quatZeros — Quaternion zeros

scalar | vector | matrix | multidimensional array

Quaternion zeros, returned as a quaternion or array of quaternions.

Given a quaternion of the form $Q = a + bi + cj + dk$, a quaternion zero is defined as $Q = 0 + 0i + 0j + 0k$.

Data Types: quaternion

Extended Capabilities

C/C++ Code Generation

Generate C and C++ code using MATLAB® Coder™.

See Also

Functions

ones

Objects

quaternion

Topics

“Rotations, Orientation, and Quaternions”

Introduced in R2018b

constvel

Constant velocity state update

Syntax

```
updatedstate = constvel(state)
updatedstate = constvel(state,dt)
updatedstate = constvel(state,w,dt)
```

Description

`updatedstate = constvel(state)` returns the updated state, `state`, of a constant-velocity Kalman filter motion model after a one-second time step.

`updatedstate = constvel(state,dt)` specifies the time step, `dt`.

`updatedstate = constvel(state,w,dt)` also specifies state noise, `w`.

Examples

Update State for Constant-Velocity Motion

Update the state of two-dimensional constant-velocity motion for a time interval of one second.

```
state = [1;1;2;1];
state = constvel(state)
```

```
state = 4×1
```

```
    2
    1
    3
    1
```

Update State for Constant-Velocity Motion with Specified Time Step

Update the state of two-dimensional constant-velocity motion for a time interval of 1.5 seconds.

```
state = [1;1;2;1];
state = constvel(state,1.5)
```

```
state = 4×1
```

```
    2.5000
    1.0000
    3.5000
    1.0000
```

Input Arguments

state — Kalman filter state vector

real-valued $2N$ -element vector

Kalman filter state vector for constant-velocity motion, specified as a real-valued $2N$ -element column vector where N is the number of spatial degrees of freedom of motion. The state is expected to be Cartesian state. For each spatial degree of motion, the state vector takes the form shown in this table.

Spatial Dimensions	State Vector Structure
1-D	$[x; vx]$
2-D	$[x; vx; y; vy]$
3-D	$[x; vx; y; vy; z; vz]$

For example, x represents the x -coordinate and vx represents the velocity in the x -direction. If the motion model is 1-D, values along the y and z axes are assumed to be zero. If the motion model is 2-D, values along the z axis are assumed to be zero. Position coordinates are in meters and velocity coordinates are in meters/sec.

Example: $[5; .1; 0; -.2; -3; .05]$

Data Types: `single` | `double`

dt — Time step interval of filter

1.0 (default) | positive scalar

Time step interval of filter, specified as a positive scalar. Time units are in seconds.

Example: 0.5

Data Types: `single` | `double`

w — State noise

scalar | real-valued D -by- N matrix

State noise, specified as a scalar or real-valued D -by- N matrix. D is the number of motion dimensions and N is the number of state vectors. For example, $D = 2$ for the 2-D motion. If specified as a scalar, the scalar value is expanded to a D -by- N matrix.

Data Types: `single` | `double`

Output Arguments

updatedstate — Updated state vector

real-valued column or row vector | real-valued matrix

Updated state vector, returned as a real-valued vector or real-valued matrix with same number of elements and dimensions as the input state vector.

Algorithms

For a two-dimensional constant-velocity process, the state transition matrix after a time step, T , is block diagonal as shown here.

$$\begin{bmatrix} x_{k+1} \\ v_{x,k+1} \\ y_{k+1} \\ v_{y,k+1} \end{bmatrix} = \begin{bmatrix} 1 & T & 0 & 0 \\ 0 & 1 & 0 & 0 \\ 0 & 0 & 1 & T \\ 0 & 0 & 0 & 1 \end{bmatrix} \begin{bmatrix} x_k \\ vx_k \\ y_k \\ vy_k \end{bmatrix}$$

The block for each spatial dimension is:

$$\begin{bmatrix} 1 & T \\ 0 & 1 \end{bmatrix}$$

For each additional spatial dimension, add an identical block.

Extended Capabilities

C/C++ Code Generation

Generate C and C++ code using MATLAB® Coder™.

See Also

Functions

cameas | cameasjac | constacc | constaccjac | constturn | constturnjac | constveljac | ctmeas | ctmeasjac | cvmeas | cvmeasjac

Objects

trackingCKF | trackingEKF | trackingKF | trackingMSCEKF | trackingPF | trackingUKF

Introduced in R2018b

constveljac

Jacobian for constant-velocity motion

Syntax

```
jacobian = constveljac(state)
jacobian = constveljac(state,dt)
[jacobian,noisejacobian] = constveljac(state,w,dt)
```

Description

`jacobian = constveljac(state)` returns the updated Jacobian , `jacobian`, for a constant-velocity Kalman filter motion model for a step time of one second. The `state` argument specifies the current state of the filter.

`jacobian = constveljac(state,dt)` specifies the time step, `dt`.

`[jacobian,noisejacobian] = constveljac(state,w,dt)` specifies the state noise, `w`, and returns the Jacobian, `noisejacobian`, of the state with respect to the noise.

Examples

Compute State Jacobian for Constant-Velocity Motion

Compute the state Jacobian for a two-dimensional constant-velocity motion model for a one second update time.

```
state = [1,1,2,1].';
jacobian = constveljac(state)
```

```
jacobian = 4×4
```

```

1     1     0     0
0     1     0     0
0     0     1     1
0     0     0     1
```

Compute State Jacobian for Constant-Velocity Motion with Specified Time Step

Compute the state Jacobian for a two-dimensional constant-velocity motion model for a half-second update time.

```
state = [1;1;2;1];
```

Compute the state update Jacobian for 0.5 second.

```
jacobian = constveljac(state,0.5)
```

```
jacobian = 4x4
    1.0000    0.5000         0         0
         0    1.0000         0         0
         0         0    1.0000    0.5000
         0         0         0    1.0000
```

Input Arguments

state — Kalman filter state vector

real-valued $2N$ -element vector

Kalman filter state vector for constant-velocity motion, specified as a real-valued $2N$ -element column vector where N is the number of spatial degrees of freedom of motion. The `state` is expected to be Cartesian state. For each spatial degree of motion, the state vector takes the form shown in this table.

Spatial Dimensions	State Vector Structure
1-D	[x; vx]
2-D	[x; vx; y; vy]
3-D	[x; vx; y; vy; z; vz]

For example, `x` represents the x -coordinate and `vx` represents the velocity in the x -direction. If the motion model is 1-D, values along the y and z axes are assumed to be zero. If the motion model is 2-D, values along the z axis are assumed to be zero. Position coordinates are in meters and velocity coordinates are in meters/sec.

Example: [5; .1; 0; -.2; -3; .05]

Data Types: single | double

dt — Time step interval of filter

1.0 (default) | positive scalar

Time step interval of filter, specified as a positive scalar. Time units are in seconds.

Example: 0.5

Data Types: single | double

w — State noise

scalar | real-valued N -by-1 vector

State noise, specified as a scalar or real-valued real valued N -by-1 vector. N is the number of motion dimensions. For example, $N = 2$ for the 2-D motion. If specified as a scalar, the scalar value is expanded to an N -by-1 vector.

Data Types: single | double

Output Arguments

jacobian — Constant-velocity motion Jacobian

real-valued $2N$ -by- $2N$ matrix

Constant-velocity motion Jacobian, returned as a real-valued $2N$ -by- $2N$ matrix. N is the number of spatial degrees of motion.

noisejacobian — Constant velocity motion noise Jacobian

real-valued $2N$ -by- N matrix

Constant velocity motion noise Jacobian, returned as a real-valued $2N$ -by- N matrix. N is the number of spatial degrees of motion. The Jacobian is constructed from the partial derivatives of the state at the updated time step with respect to the noise components.

Algorithms

For a two-dimensional constant-velocity motion, the Jacobian matrix for a time step, T , is block diagonal:

$$\begin{bmatrix} 1 & T & 0 & 0 \\ 0 & 1 & 0 & 0 \\ 0 & 0 & 1 & T \\ 0 & 0 & 0 & 1 \end{bmatrix}$$

The block for each spatial dimension has this form:

$$\begin{bmatrix} 1 & T \\ 0 & 1 \end{bmatrix}$$

For each additional spatial dimension, add an identical block.

Extended Capabilities

C/C++ Code Generation

Generate C and C++ code using MATLAB® Coder™.

See Also

Functions

cameas | cameasjac | constacc | constaccjac | constturn | constturnjac | constvel | ctmeas | ctmeasjac | cvmeas | cvmeasjac

Objects

trackingCKF | trackingEKF | trackingKF | trackingMSCEKF | trackingPF | trackingUKF

Introduced in R2018b

cvmeas

Measurement function for constant velocity motion

Syntax

```
measurement = cvmeas(state)
measurement = cvmeas(state, frame)
measurement = cvmeas(state, frame, sensorpos)
measurement = cvmeas(state, frame, sensorpos, sensorvel)
measurement = cvmeas(state, frame, sensorpos, sensorvel, laxes)
measurement = cvmeas(state, measurementParameters)
```

Description

`measurement = cvmeas(state)` returns the measurement for a constant-velocity Kalman filter motion model in rectangular coordinates. The `state` argument specifies the current state of the tracking filter.

`measurement = cvmeas(state, frame)` also specifies the measurement coordinate system, `frame`.

`measurement = cvmeas(state, frame, sensorpos)` also specifies the sensor position, `sensorpos`.

`measurement = cvmeas(state, frame, sensorpos, sensorvel)` also specifies the sensor velocity, `sensorvel`.

`measurement = cvmeas(state, frame, sensorpos, sensorvel, laxes)` specifies the local sensor axes orientation, `laxes`.

`measurement = cvmeas(state, measurementParameters)` specifies the measurement parameters, `measurementParameters`.

Examples

Create Measurement from Constant-Velocity Object in Rectangular Frame

Define the state of an object in 2-D constant-velocity motion. The state is the position and velocity in both dimensions. The measurements are in rectangular coordinates.

```
state = [1;10;2;20];
measurement = cvmeas(state)
```

```
measurement = 3×1
```

```
1
2
0
```

The z-component of the measurement is zero.

Create Measurement from Constant Velocity Object in Spherical Frame

Define the state of an object in 2-D constant-velocity motion. The state is the position and velocity in each spatial dimension. The measurements are in spherical coordinates.

```
state = [1;10;2;20];
measurement = cvmeas(state, 'spherical')
```

```
measurement = 4×1
```

```
63.4349
    0
  2.2361
 22.3607
```

The elevation of the measurement is zero and the range rate is positive. These results indicate that the object is moving away from the sensor.

Create Measurement from Constant-Velocity Object in Translated Spherical Frame

Define the state of an object in 2-D constant-velocity motion. The state consists of position and velocity in each spatial dimension. The measurements are in spherical coordinates with respect to a frame located at (20;40;0) meters.

```
state = [1;10;2;20];
measurement = cvmeas(state, 'spherical', [20;40;0])
```

```
measurement = 4×1
```

```
-116.5651
    0
  42.4853
 -22.3607
```

The elevation of the measurement is zero and the range rate is negative. These results indicate that the object is moving toward the sensor.

Create Measurement from Constant-Velocity Object Using Measurement Parameters

Define the state of an object in 2-D constant-velocity motion. The state consists of position and velocity in each spatial dimension. The measurements are in spherical coordinates with respect to a frame located at (20;40;0) meters.

```
state2d = [1;10;2;20];
frame = 'spherical';
```

```

sensorpos = [20;40;0];
sensorvel = [0;5;0];
laxes = eye(3);
measurement = cvmeas(state2d,frame,sensorpos,sensorvel,laxes)

```

```

measurement = 4×1

```

```

-116.5651
    0
  42.4853
 -17.8885

```

The elevation of the measurement is zero and the range rate is negative. These results indicate that the object is moving toward the sensor.

Put the measurement parameters in a structure and use the alternative syntax.

```

measparm = struct('Frame',frame,'OriginPosition',sensorpos,'OriginVelocity',sensorvel, ...
    'Orientation',laxes);
measurement = cvmeas(state2d,measparm)

```

```

measurement = 4×1

```

```

-116.5651
    0
  42.4853
 -17.8885

```

Input Arguments

state — Kalman filter state vector

real-valued $2N$ -element vector

Kalman filter state vector for constant-velocity motion, specified as a real-valued $2N$ -element column vector where N is the number of spatial degrees of freedom of motion. The state is expected to be Cartesian state. For each spatial degree of motion, the state vector takes the form shown in this table.

Spatial Dimensions	State Vector Structure
1-D	[x;vx]
2-D	[x;vx;y;vy]
3-D	[x;vx;y;vy;z;vz]

For example, x represents the x -coordinate and vx represents the velocity in the x -direction. If the motion model is 1-D, values along the y and z axes are assumed to be zero. If the motion model is 2-D, values along the z axis are assumed to be zero. Position coordinates are in meters and velocity coordinates are in meters/sec.

Example: [5;.1;0;-.2;-3;.05]

Data Types: single | double

frame — Measurement output frame

'rectangular' (default) | 'spherical'

Measurement output frame, specified as 'rectangular' or 'spherical'. When the frame is 'rectangular', a measurement consists of x, y, and z Cartesian coordinates. When specified as 'spherical', a measurement consists of azimuth, elevation, range, and range rate.

Data Types: char

sensorpos — Sensor position

[0;0;0] (default) | real-valued 3-by-1 column vector

Sensor position with respect to the navigation frame, specified as a real-valued 3-by-1 column vector. Units are in meters.

Data Types: double

sensorvel — Sensor velocity

[0;0;0] (default) | real-valued 3-by-1 column vector

Sensor velocity with respect to the navigation frame, specified as a real-valued 3-by-1 column vector. Units are in m/s.

Data Types: double

laxes — Local sensor coordinate axes

[1,0,0;0,1,0;0,0,1] (default) | 3-by-3 orthogonal matrix

Local sensor coordinate axes, specified as a 3-by-3 orthogonal matrix. Each column specifies the direction of the local x-, y-, and z-axes, respectively, with respect to the navigation frame. That is, the matrix is the rotation matrix from the global frame to the sensor frame.

Data Types: double

measurementParameters — Measurement parameters

structure | array of structure

Measurement parameters, specified as a structure or an array of structures. The fields of the structure are:

Field	Description	Example
Frame	Frame used to report measurements, specified as one of these values: <ul style="list-style-type: none"> 'rectangular' — Detections are reported in rectangular coordinates. 'spherical' — Detections are reported in spherical coordinates. 	'spherical'
OriginPosition	Position offset of the origin of the frame relative to the parent frame, specified as an [x y z] real-valued vector.	[0 0 0]

Field	Description	Example
OriginVelocity	Velocity offset of the origin of the frame relative to the parent frame, specified as a [vx vy vz] real-valued vector.	[0 0 0]
Orientation	Frame rotation matrix, specified as a 3-by-3 real-valued orthonormal matrix.	[1 0 0; 0 1 0; 0 0 1]
HasAzimuth	Logical scalar indicating if azimuth is included in the measurement.	1
HasElevation	Logical scalar indicating if elevation is included in the measurement. For measurements reported in a rectangular frame, and if HasElevation is false, the reported measurements assume 0 degrees of elevation.	1
HasRange	Logical scalar indicating if range is included in the measurement.	1
HasVelocity	Logical scalar indicating if the reported detections include velocity measurements. For measurements reported in the rectangular frame, if HasVelocity is false, the measurements are reported as [x y z]. If HasVelocity is true, measurements are reported as [x y z vx vy vz].	1
IsParentToChild	Logical scalar indicating if Orientation performs a frame rotation from the parent coordinate frame to the child coordinate frame. When IsParentToChild is false, then Orientation performs a frame rotation from the child coordinate frame to the parent coordinate frame.	0

If you only want to perform one coordinate transformation, such as a transformation from the body frame to the sensor frame, you only need to specify a measurement parameter structure. If you want to perform multiple coordinate transformations, you need to specify an array of measurement parameter structures. To learn how to perform multiple transformations, see the “Convert Detections to objectDetection Format” example.

Data Types: struct

Output Arguments

measurement — Measurement vector

N-by-1 column vector

Measurement vector, returned as an *N*-by-1 column vector. The form of the measurement depends upon which syntax you use.

- When the syntax does not use the `measurementParameters` argument, the measurement vector is `[x,y,z]` when the `frame` input argument is set to `'rectangular'` and `[az;el;r;rr]` when the `frame` is set to `'spherical'`.
- When the syntax uses the `measurementParameters` argument, the size of the measurement vector depends on the values of the `frame`, `HasVelocity`, and `HasElevation` fields in the `measurementParameters` structure.

frame	measurement															
'spherical'	<p>Specifies the azimuth angle, <i>az</i>, elevation angle, <i>el</i>, range, <i>r</i>, and range rate, <i>rr</i>, of the object with respect to the local ego vehicle coordinate system. Positive values for range rate indicate that an object is moving away from the sensor.</p> <p>Spherical measurements</p> <table border="1"> <thead> <tr> <th></th> <th></th> <th colspan="2">HasElevation</th> </tr> <tr> <th></th> <th></th> <th>false</th> <th>true</th> </tr> </thead> <tbody> <tr> <td rowspan="2">HasVelocity</td> <td>false</td> <td>[az;r]</td> <td>[az;el;r]</td> </tr> <tr> <td>true</td> <td>[az;r;rr]</td> <td>[az;el;r;rr]</td> </tr> </tbody> </table> <p>Angle units are in degrees, range units are in meters, and range rate units are in m/s.</p>			HasElevation				false	true	HasVelocity	false	[az;r]	[az;el;r]	true	[az;r;rr]	[az;el;r;rr]
		HasElevation														
		false	true													
HasVelocity	false	[az;r]	[az;el;r]													
	true	[az;r;rr]	[az;el;r;rr]													
'rectangular'	<p>Specifies the Cartesian position and velocity coordinates of the tracked object with respect to the ego vehicle coordinate system.</p> <p>Rectangular measurements</p> <table border="1"> <thead> <tr> <th>HasVelocity</th> <th></th> <th></th> </tr> </thead> <tbody> <tr> <td>false</td> <td></td> <td>[x;y;y]</td> </tr> <tr> <td>true</td> <td></td> <td>[x;y;z;vx;vy;vz]</td> </tr> </tbody> </table> <p>Position units are in meters and velocity units are in m/s.</p>	HasVelocity			false		[x;y;y]	true		[x;y;z;vx;vy;vz]						
HasVelocity																
false		[x;y;y]														
true		[x;y;z;vx;vy;vz]														

Data Types: double

More About

Azimuth and Elevation Angle Definitions

Define the azimuth and elevation angles used in the toolbox.

The azimuth angle of a vector is the angle between the x -axis and its orthogonal projection onto the xy plane. The angle is positive in going from the x axis toward the y axis. Azimuth angles lie between -180 and 180 degrees. The elevation angle is the angle between the vector and its orthogonal projection onto the xy -plane. The angle is positive when going toward the positive z -axis from the xy plane.

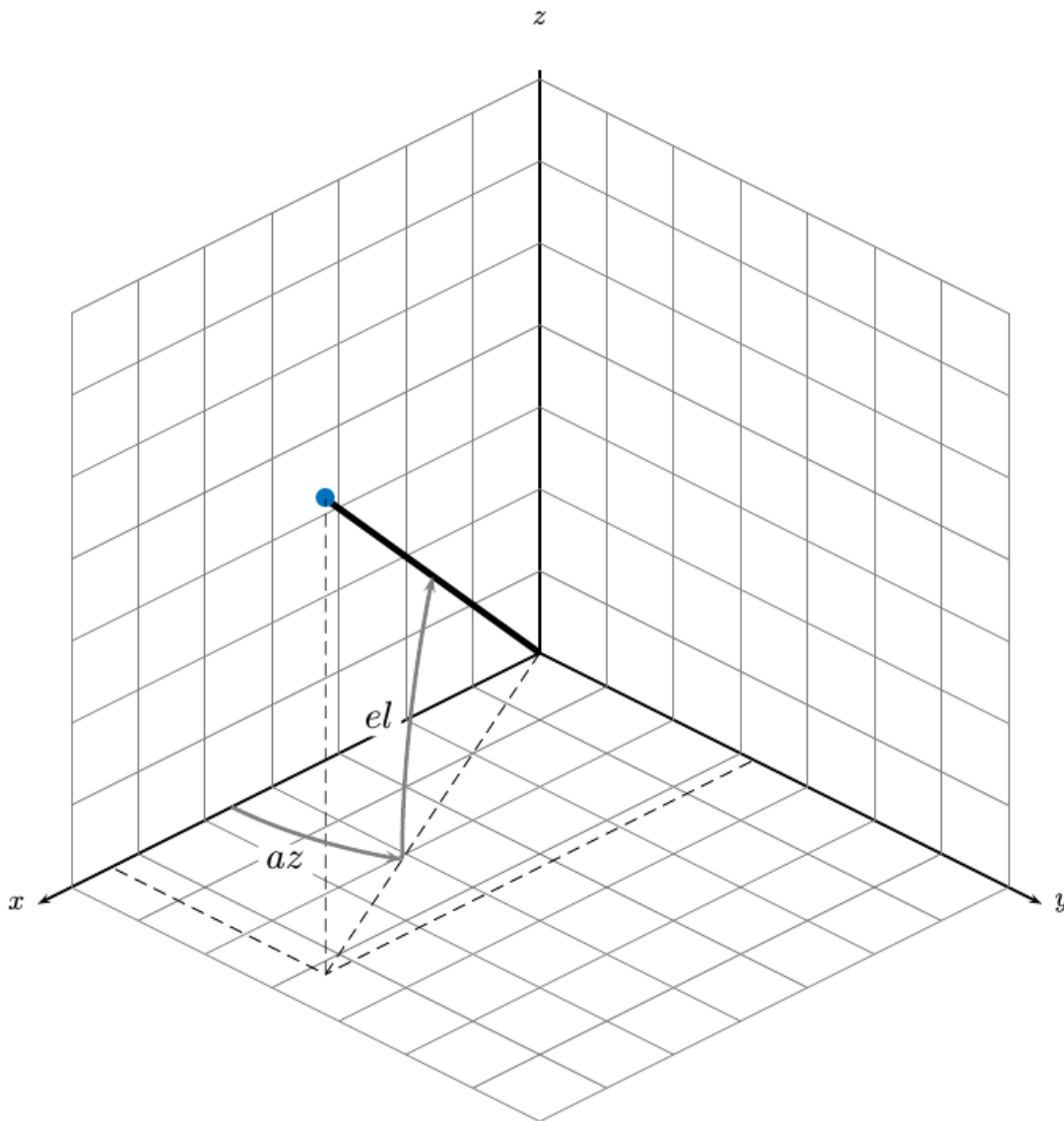

Extended Capabilities

C/C++ Code Generation

Generate C and C++ code using MATLAB® Coder™.

See Also

Functions

[cameas](#) | [cameasjac](#) | [constacc](#) | [constaccjac](#) | [constturn](#) | [constturnjac](#) | [constvel](#) | [constveljac](#) | [ctmeas](#) | [ctmeasjac](#) | [cvmeasjac](#)

Objects

[trackingCKF](#) | [trackingEKF](#) | [trackingKF](#) | [trackingMSCEKF](#) | [trackingPF](#) | [trackingUKF](#)

Introduced in R2018b

cvmeasjac

Jacobian of measurement function for constant velocity motion

Syntax

```
measurementjac = cvmeasjac(state)
measurementjac = cvmeasjac(state, frame)
measurementjac = cvmeasjac(state, frame, sensorpos)
measurementjac = cvmeasjac(state, frame, sensorpos, sensorvel)
measurementjac = cvmeasjac(state, frame, sensorpos, sensorvel, laxes)
measurementjac = cvmeasjac(state, measurementParameters)
```

Description

`measurementjac = cvmeasjac(state)` returns the measurement Jacobian for constant-velocity Kalman filter motion model in rectangular coordinates. `state` specifies the current state of the tracking filter.

`measurementjac = cvmeasjac(state, frame)` also specifies the measurement coordinate system, `frame`.

`measurementjac = cvmeasjac(state, frame, sensorpos)` also specifies the sensor position, `sensorpos`.

`measurementjac = cvmeasjac(state, frame, sensorpos, sensorvel)` also specifies the sensor velocity, `sensorvel`.

`measurementjac = cvmeasjac(state, frame, sensorpos, sensorvel, laxes)` also specifies the local sensor axes orientation, `laxes`.

`measurementjac = cvmeasjac(state, measurementParameters)` specifies the measurement parameters, `measurementParameters`.

Examples

Measurement Jacobian of Constant-Velocity Object in Rectangular Frame

Define the state of an object in 2-D constant-velocity motion. The state is the position and velocity in each spatial dimension. Construct the measurement Jacobian in rectangular coordinates.

```
state = [1;10;2;20];
jacobian = cvmeasjac(state)
```

```
jacobian = 3×4
```

```
    1    0    0    0
    0    0    1    0
    0    0    0    0
```

Measurement Jacobian of Constant-Velocity Motion in Spherical Frame

Define the state of an object in 2-D constant-velocity motion. The state is the position and velocity in each dimension. Compute the measurement Jacobian with respect to spherical coordinates.

```
state = [1;10;2;20];
measurementjac = cvmeasjac(state, 'spherical')
```

```
measurementjac = 4x4
```

```
-22.9183      0    11.4592      0
      0      0      0      0
  0.4472      0    0.8944      0
  0.0000    0.4472    0.0000    0.8944
```

Measurement Jacobian of Constant-Velocity Object in Translated Spherical Frame

Define the state of an object in 2-D constant-velocity motion. The state is the position and velocity in each spatial dimension. Compute the measurement Jacobian with respect to spherical coordinates centered at (5;-20;0) meters.

```
state = [1;10;2;20];
sensorpos = [5;-20;0];
measurementjac = cvmeasjac(state, 'spherical', sensorpos)
```

```
measurementjac = 4x4
```

```
-2.5210      0   -0.4584      0
      0      0      0      0
-0.1789      0    0.9839      0
 0.5903   -0.1789    0.1073    0.9839
```

Create Measurement Jacobian for Constant-Velocity Object Using Measurement Parameters

Define the state of an object in 2-D constant-velocity motion. The state consists of position and velocity in each spatial dimension. The measurements are in spherical coordinates with respect to a frame located at (20;40;0) meters.

```
state2d = [1;10;2;20];
frame = 'spherical';
sensorpos = [20;40;0];
sensorvel = [0;5;0];
laxes = eye(3);
measurementjac = cvmeasjac(state2d, frame, sensorpos, sensorvel, laxes)
```

```
measurementjac = 4x4
```

```
 1.2062      0   -0.6031      0
      0      0      0      0
```

```
-0.4472      0      -0.8944      0
 0.0471    -0.4472    -0.0235    -0.8944
```

Put the measurement parameters in a structure and use the alternative syntax.

```
measparm = struct('Frame',frame,'OriginPosition',sensorpos,'OriginVelocity',sensorvel, ...
    'Orientation',laxes);
measurementjac = cvmeasjac(state2d,measparm)
```

measurementjac = 4x4

```
 1.2062      0    -0.6031      0
      0      0      0      0
 -0.4472      0    -0.8944      0
 0.0471    -0.4472    -0.0235    -0.8944
```

Input Arguments

state — Kalman filter state vector

real-valued 2N-element vector

Kalman filter state vector for constant-velocity motion, specified as a real-valued 2N-element column vector where N is the number of spatial degrees of freedom of motion. The state is expected to be Cartesian state. For each spatial degree of motion, the state vector takes the form shown in this table.

Spatial Dimensions	State Vector Structure
1-D	[x;vx]
2-D	[x;vx;y;vy]
3-D	[x;vx;y;vy;z;vz]

For example, x represents the x-coordinate and vx represents the velocity in the x-direction. If the motion model is 1-D, values along the y and z axes are assumed to be zero. If the motion model is 2-D, values along the z axis are assumed to be zero. Position coordinates are in meters and velocity coordinates are in meters/sec.

Example: [5;.1;0;-.2;-3;.05]

Data Types: single | double

frame — Measurement output frame

'rectangular' (default) | 'spherical'

Measurement output frame, specified as 'rectangular' or 'spherical'. When the frame is 'rectangular', a measurement consists of x, y, and z Cartesian coordinates. When specified as 'spherical', a measurement consists of azimuth, elevation, range, and range rate.

Data Types: char

sensorpos — Sensor position

[0;0;0] (default) | real-valued 3-by-1 column vector

Sensor position with respect to the navigation frame, specified as a real-valued 3-by-1 column vector. Units are in meters.

Data Types: double

sensorvel — Sensor velocity

[0;0;0] (default) | real-valued 3-by-1 column vector

Sensor velocity with respect to the navigation frame, specified as a real-valued 3-by-1 column vector. Units are in m/s.

Data Types: double

laxes — Local sensor coordinate axes

[1,0,0;0,1,0;0,0,1] (default) | 3-by-3 orthogonal matrix

Local sensor coordinate axes, specified as a 3-by-3 orthogonal matrix. Each column specifies the direction of the local x-, y-, and z-axes, respectively, with respect to the navigation frame. That is, the matrix is the rotation matrix from the global frame to the sensor frame.

Data Types: double

measurementParameters — Measurement parameters

structure | array of structure

Measurement parameters, specified as a structure or an array of structures. The fields of the structure are:

Field	Description	Example
Frame	Frame used to report measurements, specified as one of these values: <ul style="list-style-type: none"> 'rectangular' — Detections are reported in rectangular coordinates. 'spherical' — Detections are reported in spherical coordinates. 	'spherical'
OriginPosition	Position offset of the origin of the frame relative to the parent frame, specified as an [x y z] real-valued vector.	[0 0 0]
OriginVelocity	Velocity offset of the origin of the frame relative to the parent frame, specified as a [vx vy vz] real-valued vector.	[0 0 0]
Orientation	Frame rotation matrix, specified as a 3-by-3 real-valued orthonormal matrix.	[1 0 0; 0 1 0; 0 0 1]
HasAzimuth	Logical scalar indicating if azimuth is included in the measurement.	1

Field	Description	Example
HasElevation	Logical scalar indicating if elevation is included in the measurement. For measurements reported in a rectangular frame, and if HasElevation is false, the reported measurements assume 0 degrees of elevation.	1
HasRange	Logical scalar indicating if range is included in the measurement.	1
HasVelocity	Logical scalar indicating if the reported detections include velocity measurements. For measurements reported in the rectangular frame, if HasVelocity is false, the measurements are reported as [x y z]. If HasVelocity is true, measurements are reported as [x y z vx vy vz].	1
IsParentToChild	Logical scalar indicating if Orientation performs a frame rotation from the parent coordinate frame to the child coordinate frame. When IsParentToChild is false, then Orientation performs a frame rotation from the child coordinate frame to the parent coordinate frame.	0

If you only want to perform one coordinate transformation, such as a transformation from the body frame to the sensor frame, you only need to specify a measurement parameter structure. If you want to perform multiple coordinate transformations, you need to specify an array of measurement parameter structures. To learn how to perform multiple transformations, see the “Convert Detections to objectDetection Format” example.

Data Types: struct

Output Arguments

measurementjac — Measurement Jacobian

real-valued 3-by-*N* matrix | real-valued 4-by-*N* matrix

Measurement Jacobian, specified as a real-valued 3-by-*N* or 4-by-*N* matrix. *N* is the dimension of the state vector. The first dimension and meaning depend on value of the frame argument.

Frame	Measurement Jacobian
'rectangular'	Jacobian of the measurements $[x; y; z]$ with respect to the state vector. The measurement vector is with respect to the local coordinate system. Coordinates are in meters.
'spherical'	Jacobian of the measurement vector $[az; el; r; rr]$ with respect to the state vector. Measurement vector components specify the azimuth angle, elevation angle, range, and range rate of the object with respect to the local sensor coordinate system. Angle units are in degrees. Range units are in meters and range rate units are in meters/second.

More About

Azimuth and Elevation Angle Definitions

Define the azimuth and elevation angles used in the toolbox.

The azimuth angle of a vector is the angle between the x -axis and its orthogonal projection onto the xy plane. The angle is positive in going from the x axis toward the y axis. Azimuth angles lie between -180 and 180 degrees. The elevation angle is the angle between the vector and its orthogonal projection onto the xy -plane. The angle is positive when going toward the positive z -axis from the xy plane.

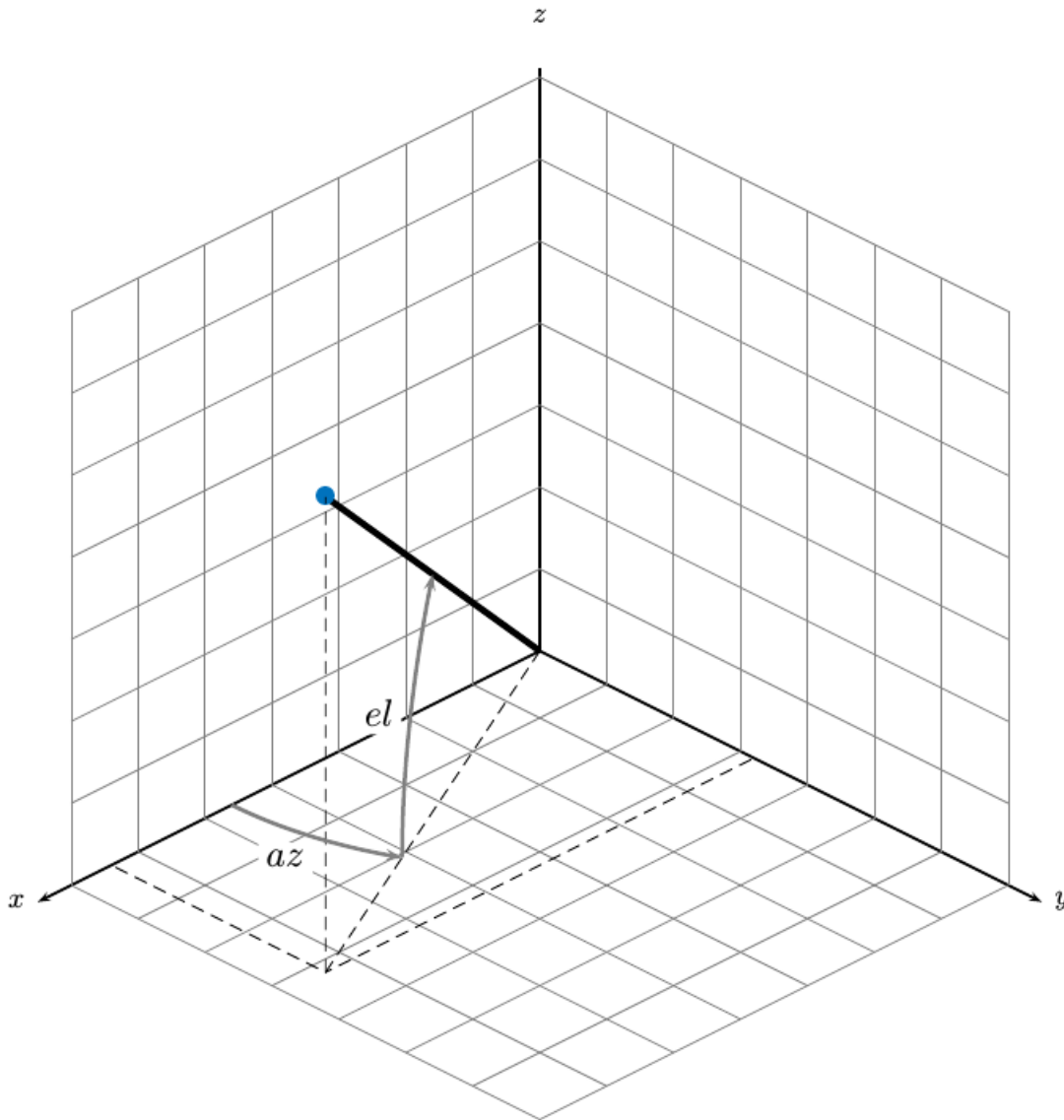

Extended Capabilities

C/C++ Code Generation

Generate C and C++ code using MATLAB® Coder™.

See Also

Functions

cameas | cameasjac | constacc | constaccjac | constturn | constturnjac | constvel | constveljac | ctmeas | ctmeasjac | cvmeas

Objects

trackingCKF | trackingEKF | trackingKF | trackingMSCEKF | trackingPF | trackingUKF

Introduced in R2018b

constacc

Constant-acceleration motion model

Syntax

```
updatedstate = constacc(state)
updatedstate = constacc(state,dt)
updatedstate = constacc(state,w,dt)
```

Description

`updatedstate = constacc(state)` returns the updated state, `state`, of a constant acceleration Kalman filter motion model for a step time of one second.

`updatedstate = constacc(state,dt)` specifies the time step, `dt`.

`updatedstate = constacc(state,w,dt)` also specifies the state noise, `w`.

Examples

Predict State for Constant-Acceleration Motion

Define an initial state for 2-D constant-acceleration motion.

```
state = [1;1;1;2;1;0];
```

Predict the state 1 second later.

```
state = constacc(state)
```

```
state = 6×1
```

```
2.5000
2.0000
1.0000
3.0000
1.0000
0
```

Predict State for Constant-Acceleration Motion With Specified Time Step

Define an initial state for 2-D constant-acceleration motion.

```
state = [1;1;1;2;1;0];
```

Predict the state 0.5 s later.

```
state = constacc(state,0.5)
```

```
state = 6×1

    1.6250
    1.5000
    1.0000
    2.5000
    1.0000
    0
```

Input Arguments

state — Kalman filter state vector

real-valued $3N$ -element vector

Kalman filter state vector for constant-acceleration motion, specified as a real-valued $3N$ -element vector. N is the number of spatial degrees of freedom of motion. For each spatial degree of motion, the state vector takes the form shown in this table.

Spatial Dimensions	State Vector Structure
1-D	[x; vx; ax]
2-D	[x; vx; ax; y; vy; ay]
3-D	[x; vx; ax; y; vy; ay; z; vz; az]

For example, x represents the x -coordinate, v_x represents the velocity in the x -direction, and a_x represents the acceleration in the x -direction. If the motion model is in one-dimensional space, the y - and z -axes are assumed to be zero. If the motion model is in two-dimensional space, values along the z -axis are assumed to be zero. Position coordinates are in meters. Velocity coordinates are in meters/second. Acceleration coordinates are in meters/second².

Example: [5;0.1;0.01;0;-0.2;-0.01;-3;0.05;0]

Data Types: double

dt — Time step interval of filter

1.0 (default) | positive scalar

Time step interval of filter, specified as a positive scalar. Time units are in seconds.

Example: 0.5

Data Types: single | double

w — State noise

scalar | real-valued D -by- N matrix

State noise, specified as a scalar or real-valued D -by- N matrix. D is the number of motion dimensions and N is the number of state vectors. If specified as a scalar, the scalar value is expanded to a D -by- N matrix.

Data Types: single | double

Output Arguments

updatedstate — Updated state vector

real-valued column or row vector | real-valued matrix

Updated state vector, returned as a real-valued vector or real-valued matrix with same number of elements and dimensions as the input state vector.

Algorithms

For a two-dimensional constant-acceleration process, the state transition matrix after a time step, T , is block diagonal:

$$\begin{bmatrix} x_{k+1} \\ vx_{k+1} \\ ax_{k+1} \\ y_{k+1} \\ vy_{k+1} \\ ay_{k+1} \end{bmatrix} = \begin{bmatrix} 1 & T & \frac{1}{2}T^2 & 0 & 0 & 0 \\ 0 & 1 & T & 0 & 0 & 0 \\ 0 & 0 & 1 & 0 & 0 & 0 \\ 0 & 0 & 0 & 1 & T & \frac{1}{2}T^2 \\ 0 & 0 & 0 & 0 & 1 & T \\ 0 & 0 & 0 & 0 & 0 & 1 \end{bmatrix} \begin{bmatrix} x_k \\ vx_k \\ ax_k \\ y_k \\ vy_k \\ ay_k \end{bmatrix}$$

The block for each spatial dimension has this form:

$$\begin{bmatrix} 1 & T & \frac{1}{2}T^2 \\ 0 & 1 & T \\ 0 & 0 & 1 \end{bmatrix}$$

For each additional spatial dimension, add an identical block.

Extended Capabilities

C/C++ Code Generation

Generate C and C++ code using MATLAB® Coder™.

See Also

Functions

cameas | cameasjac | constaccjac | constturn | constturnjac | constvel | constveljac | ctmeas | ctmeasjac | cvmeas | cvmeasjac

Objects

trackingCKF | trackingEKF | trackingKF | trackingMSCEKF | trackingPF | trackingUKF

Introduced in R2018b

constaccjac

Jacobian for constant-acceleration motion

Syntax

```
jacobian = constaccjac(state)
jacobian = constaccjac(state,dt)
[jacobian,noisejacobian] = constaccjac(state,w,dt)
```

Description

`jacobian = constaccjac(state)` returns the updated Jacobian , `jacobian`, for a constant-acceleration Kalman filter motion model. The step time is one second. The `state` argument specifies the current state of the filter.

`jacobian = constaccjac(state,dt)` also specifies the time step, `dt`.

`[jacobian,noisejacobian] = constaccjac(state,w,dt)` specifies the state noise, `w`, and returns the Jacobian, `noisejacobian`, of the state with respect to the noise.

Examples

Compute State Jacobian for Constant-Acceleration Motion

Compute the state Jacobian for two-dimensional constant-acceleration motion.

Define an initial state and compute the state Jacobian for a one second update time.

```
state = [1,1,1,2,1,0];
jacobian = constaccjac(state)
```

`jacobian = 6×6`

```

    1.0000    1.0000    0.5000         0         0         0
         0    1.0000    1.0000         0         0         0
         0         0    1.0000         0         0         0
         0         0         0    1.0000    1.0000    0.5000
         0         0         0         0    1.0000    1.0000
         0         0         0         0         0    1.0000
```

Compute State Jacobian for Constant-Acceleration Motion with Specified Time Step

Compute the state Jacobian for two-dimensional constant-acceleration motion. Set the step time to 0.5 seconds.

```
state = [1,1,1,2,1,0].';
jacobian = constaccjac(state,0.5)
```

jacobian = 6x6

```

1.0000    0.5000    0.1250         0         0         0
0         1.0000    0.5000         0         0         0
0         0         1.0000         0         0         0
0         0         0         1.0000    0.5000    0.1250
0         0         0         0         1.0000    0.5000
0         0         0         0         0         1.0000
    
```

Input Arguments

state — Kalman filter state vector

real-valued $3N$ -element vector

Kalman filter state vector for constant-acceleration motion, specified as a real-valued $3N$ -element vector. N is the number of spatial degrees of freedom of motion. For each spatial degree of motion, the state vector takes the form shown in this table.

Spatial Dimensions	State Vector Structure
1-D	[x; vx; ax]
2-D	[x; vx; ax; y; vy; ay]
3-D	[x; vx; ax; y; vy; ay; z; vz; az]

For example, x represents the x -coordinate, vx represents the velocity in the x -direction, and ax represents the acceleration in the x -direction. If the motion model is in one-dimensional space, the y - and z -axes are assumed to be zero. If the motion model is in two-dimensional space, values along the z -axis are assumed to be zero. Position coordinates are in meters. Velocity coordinates are in meters/second. Acceleration coordinates are in meters/second².

Example: [5;0.1;0.01;0;-0.2;-0.01;-3;0.05;0]

Data Types: double

dt — Time step interval of filter

1.0 (default) | positive scalar

Time step interval of filter, specified as a positive scalar. Time units are in seconds.

Example: 0.5

Data Types: single | double

w — State noise

scalar | real-valued N -by-1 vector

State noise, specified as a scalar or real-valued real valued N -by-1 vector. N is the number of motion dimensions. For example, $N = 2$ for the 2-D motion. If specified as a scalar, the scalar value is expanded to a N -by-1 vector.

Data Types: single | double

Output Arguments

jacobian — Constant-acceleration motion Jacobian

real-valued $3N$ -by- $3N$ matrix

Constant-acceleration motion Jacobian, returned as a real-valued $3N$ -by- $3N$ matrix.

noisejacobian — Constant acceleration motion noise Jacobian

real-valued $3N$ -by- N matrix

Constant acceleration motion noise Jacobian, returned as a real-valued $3N$ -by- N matrix. N is the number of spatial degrees of motion. For example, $N = 2$ for the 2-D motion. The Jacobian is constructed from the partial derivatives of the state at the updated time step with respect to the noise components.

Algorithms

For a two-dimensional constant-acceleration process, the Jacobian matrix after a time step, T , is block diagonal:

$$\begin{bmatrix} 1 & T & \frac{1}{2}T^2 & 0 & 0 & 0 \\ 0 & 1 & T & 0 & 0 & 0 \\ 0 & 0 & 1 & 0 & 0 & 0 \\ 0 & 0 & 0 & 1 & T & \frac{1}{2}T^2 \\ 0 & 0 & 0 & 0 & 1 & T \\ 0 & 0 & 0 & 0 & 0 & 1 \end{bmatrix}$$

The block for each spatial dimension has this form:

$$\begin{bmatrix} 1 & T & \frac{1}{2}T^2 \\ 0 & 1 & T \\ 0 & 0 & 1 \end{bmatrix}$$

For each additional spatial dimension, add an identical block.

Extended Capabilities

C/C++ Code Generation

Generate C and C++ code using MATLAB® Coder™.

See Also

Functions

cameas | cameasjac | constacc | constturn | constturnjac | constvel | constveljac | ctmeas | ctmeasjac | cvmeas | cvmeasjac

Objects

trackingCKF | trackingEKF | trackingKF | trackingMSCEKF | trackingPF | trackingUKF

Introduced in R2018b

constvelmsc

Constant velocity (CV) motion model in MSC frame

Syntax

```
state = constvelmsc(state,vNoise)
state = constvelmsc(state,vNoise,dt)
state = constvelmsc(state,vNoise,dt,u)
```

Description

`state = constvelmsc(state,vNoise)` calculates the state at the next time-step based on current state and target acceleration noise, `vNoise`, in the scenario. The function assumes a time interval, `dt`, of one second, and zero observer acceleration in all dimensions.

`state = constvelmsc(state,vNoise,dt)` specifies the time interval, `dt`. The function assumes zero observer acceleration in all dimensions.

`state = constvelmsc(state,vNoise,dt,u)` specifies the observer input, `u`, during the time interval, `dt`.

Examples

Predict Constant Velocity MSC State with Different Inputs

Define a state vector for a 3-D MSC state.

```
mscState = [0.1;0.01;0.1;0.01;0.001;1];
dt = 0.1;
```

Predict the state with zero observer acceleration.

```
mscState = constvelmsc(mscState,zeros(3,1),dt)
```

```
mscState = 6×1
```

```
0.1009
0.0083
0.1009
0.0083
0.0009
0.9091
```

Predict the state with [5;3;1] observer acceleration in scenario.

```
mscState = constvelmsc(mscState,zeros(3,1),dt,[5;3;1])
```

```
mscState = 6×1
```

```
0.1017
```

```
0.0067
0.1017
0.0069
0.0008
0.8329
```

Predict the state with observer maneuver and unit standard deviation random noise in target acceleration. Let observer acceleration in the time interval be $[\sin(t) \cos(t)]$.

```
velManeuver = [1 - cos(dt);sin(dt);0];
posManeuver = [-sin(dt);cos(dt) - 1;0];
u = zeros(6,1);
u(1:2:end) = posManeuver;
u(2:2:end) = velManeuver;
mscState = constvelmsc(mscState,randn(3,1),dt,u)
```

```
mscState = 6×1
```

```
0.1023
0.0058
0.1023
0.0057
0.0008
0.7689
```

Predict and Measure State of Constant Velocity Target in Modified Spherical Coordinates

Define a state vector for a motion model in 2-D. The time interval is 2 seconds.

```
mscState = [0.5;0.02;1/1000;-10/1000];
dt = 2;
```

As modified spherical coordinates (MSC) state is relative, let the observer state be defined by a constant acceleration model in 2-D.

```
observerState = [100;10;0.5;20;-5;0.1];
```

Pre-allocate memory. `rPlot` is the range for plotting bearing measurements.

```
observerPositions = zeros(2,10);
targetPositions = zeros(2,10);
azimuthMeasurement = zeros(1,10);
bearingHistory = zeros(2,30);
rPlot = 2000;
```

Use a loop to predict the state multiple times. Use `constvelmsc` to create a trajectory with constant velocity target and measure the angles using the measurement function, `cvmeasmsc`.

```
for i = 1:10
    obsAcceleration = observerState(3:3:end);
    % Use zeros(2,1) as process noise to get true predictions
    mscState = constvelmsc(mscState,zeros(2,1),dt,obsAcceleration);

    % Update observer state using constant acceleration model
```

```

observerState = constacc(observerState,dt);
observerPositions(:,i) = observerState(1:3:end);

% Update bearing history with current measurement.
az = cvmeasmsc(mscState);
bearingHistory(:,3*i-2) = observerState(1:3:end);
bearingHistory(:,3*i-1) = observerState(1:3:end) + [rPlot*cosd(az);rPlot*sind(az)];
bearingHistory(:,3*i) = [NaN;NaN];

% Use the 'rectangular' frame to get relative positions of the
% target using cvmeasmsc function.
relativePosition = cvmeasmsc(mscState,'rectangular');
relativePosition2D = relativePosition(1:2);
targetPositions(:,i) = relativePosition2D + observerPositions(:,i);
end

plot(observerPositions(1,:),observerPositions(2,:)); hold on;
plot(targetPositions(1,:),targetPositions(2,:));
plot(bearingHistory(1,:),bearingHistory(2,:),'-');
title('Constant velocity model in modified spherical coordinates');xlabel('X[m]'); ylabel('Y[m]');
legend('Observer Positions', 'Target Positions', 'Bearings Measurements'); hold off;

```

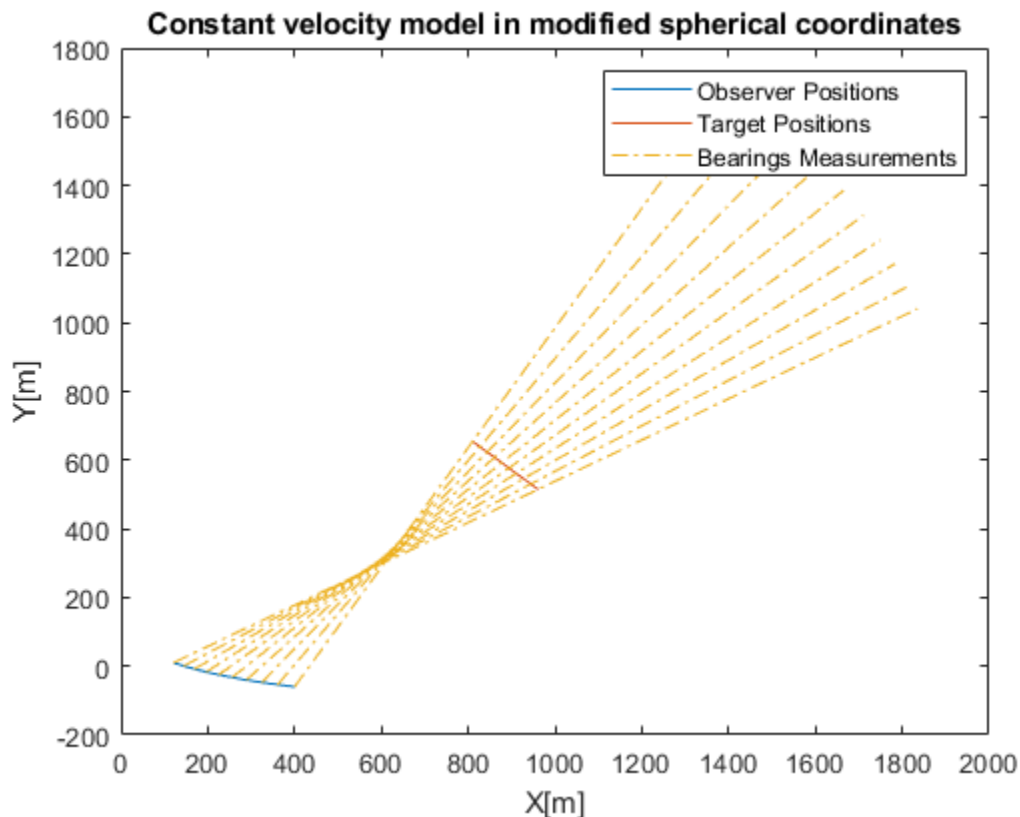

Input Arguments

state — Relative state

vector | 2-D matrix

State that is defined relative to an observer in modified spherical coordinates, specified as a vector or a 2-D matrix. For example, if there is a constant velocity target state, xT , and a constant velocity observer state, xO , then the `state` is defined as $xT - xO$ transformed in modified spherical coordinates.

The two-dimensional version of modified spherical coordinates (MSC) is also referred to as the modified polar coordinates (MPC). In the case of:

- 2-D space -- State is equal to $[az \ azRate \ 1/r \ vr/r]$
- 3-D space -- State is equal to $[az \ \omega \ el \ elRate \ 1/r \ vr/r]$

If specified as a matrix, states must be concatenated along columns, where each column represents a state following the convention specified above.

The variables used in the convention are:

- *az* -- Azimuth angle (rad)
- *el* -- Elevation angle (rad)
- *azRate* -- Azimuth rate (rad/s)
- *elRate* -- Elevation rate (rad/s)
- *omega* -- $azRate \times \cos(el)$ (rad/s)
- $1/r$ -- $1/range$ (1/m)
- vr/r -- $range\text{-}rate/range$ or inverse time-to-go (1/s)

Data Types: `single` | `double`

vNoise — Target acceleration noise

vector | matrix

Target acceleration noise in the scenario, specified as a vector of 2 or 3 elements or a matrix with dimensions corresponding to `state`. That is, if the dimensions of the `state` matrix is 6-by-10, then the acceptable dimensions for `vNoise` is 3-by-10. If the dimensions of the `state` matrix is 4-by-10, then the acceptable dimensions for `vNoise` is 2-by-10. For more details, see “Orientation, Position, and Coordinate”.

Data Types: `double`

dt — Time difference

scalar

Time difference between current state and the time at which the state is to be calculated, specified as a real finite numeric scalar.

Data Types: `single` | `double`

u — Observer input

vector

Observer input, specified as a vector. The observer input can have the following impact on state-prediction based on its dimensions:

- When the number of elements in `u` equals the number of elements in `state`, the input `u` is assumed to be the maneuver performed by the observer during the time interval, `dt`. A maneuver is defined as motion of the observer higher than first order (or constant velocity).

- When the number of elements in `u` equals half the number of elements in `state`, the input `u` is assumed to be constant acceleration of the observer, specified in the scenario frame during the time interval, `dt`.

Data Types: `double`

Output Arguments

state — State at next time step

vector | 2-D matrix | 3-D matrix

State at the next time step, returned as a vector and a matrix of two or three dimensions. The state at the next time step is calculated based on the current state and the target acceleration noise, `vNoise`.

Data Types: `double`

Algorithms

The function provides a constant velocity transition function in modified spherical coordinates (MSC) using a non-additive noise structure. The MSC frame assumes a single observer and the state is defined relative to it.

Extended Capabilities

C/C++ Code Generation

Generate C and C++ code using MATLAB® Coder™.

See Also

Objects

`trackingEKF` | `trackingMSCEKF`

Functions

`constvelmscjac`

Introduced in R2018b

constvelmscjac

Jacobian of constant velocity (CV) motion model in MSC frame

Syntax

```
[jacobianState,jacobianNoise] = constvelmscjac(state,vNoise)
[jacobianState,jacobianNoise] = constvelmscjac(state,vNoise,dt)
[jacobianState,jacobianNoise] = constvelmscjac(state,vNoise,dt,u)
```

Description

`[jacobianState,jacobianNoise] = constvelmscjac(state,vNoise)` calculates the Jacobian matrix of the motion model with respect to the state vector and the noise. The input `state` defines the current state, and `vNoise` defines the target acceleration noise in the observer's Cartesian frame. The function assumes a time interval, `dt`, of one second, and zero observer acceleration in all dimensions.

The `trackingEKF` object allows you to specify the `StateTransitionJacobianFcn` property. The function can be used as a `StateTransitionJacobianFcn` when the `HasAdditiveProcessNoise` is set to `false`.

`[jacobianState,jacobianNoise] = constvelmscjac(state,vNoise,dt)` specifies the time interval, `dt`. The function assumes zero observer acceleration in all dimensions.

`[jacobianState,jacobianNoise] = constvelmscjac(state,vNoise,dt,u)` specifies the observer input, `u`, during the time interval, `dt`.

Examples

Compute Jacobian of State Transition Function

Define a state vector for 2-D MSC.

```
state = [0.5;0.01;0.001;0.01];
```

Calculate the Jacobian matrix assuming `dt = 1` second, no observer maneuver, and zero target acceleration noise.

```
[jacobianState,jacobianNoise] = constvelmscjac(state,zeros(2,1)) %#ok
```

```
jacobianState = 4x4
```

```
    1.0000    0.9900   -0.0000   -0.0098
   -0.0000    0.9800   -0.0000   -0.0194
    0.0000   -0.0000    0.9901   -0.0010
   -0.0000    0.0194   -0.0000    0.9800
```

```
jacobianNoise = 4x2
10-3 ×
```

```

-0.2416    0.4321
-0.4851    0.8574
-0.0004   -0.0002
 0.8574    0.4851

```

Calculate the Jacobian matrix, given $dt = 0.1$ seconds, no observer maneuver, and a unit standard deviation target acceleration noise.

```
[jacobianState,jacobianNoise] = constvelmscjac(state,randn(2,1),0.1) %#ok
```

```
jacobianState = 4x4
```

```

 1.0000    0.0999    0.0067   -0.0001
-0.0001    0.9980    0.1348   -0.0020
-0.0000   -0.0000    0.9990   -0.0001
 0.0001    0.0020    0.1351    0.9980

```

```
jacobianNoise = 4x2
```

```
10-4 x
```

```

-0.0240    0.0438
-0.4800    0.8755
-0.0000   -0.0000
 0.8755    0.4800

```

Calculate the Jacobian matrix, given $dt = 0.1$ seconds and observer acceleration = [0.1 0.3] in the 2-D observer's Cartesian coordinates.

```
[jacobianState,jacobianNoise] = constvelmscjac(state,randn(2,1),0.1,[0.1;0.3])
```

```
jacobianState = 4x4
```

```

 1.0000    0.0999    0.0081   -0.0001
 0.0002    0.9980    0.1625   -0.0020
-0.0000   -0.0000    0.9990   -0.0001
 0.0002    0.0020   -0.1795    0.9980

```

```
jacobianNoise = 4x2
```

```
10-4 x
```

```

-0.0240    0.0438
-0.4800    0.8756
-0.0000   -0.0000
 0.8756    0.4800

```

Input Arguments

state — Relative state

vector

State that is defined relative to an observer in modified spherical coordinates, specified as a vector. For example, if there is a constant velocity target state, xT , and a constant velocity observer state, xO , then the state is defined as $xT - xO$ transformed in modified spherical coordinates.

The two-dimensional version of modified spherical coordinates (MSC) is also referred to as the modified polar coordinates (MPC).

In case the motion is in:

- 2-D space -- State is equal to $[az \ azRate \ 1/r \ vr/r]$
- 3-D space -- State is equal to $[az \ \omega \ el \ elRate \ 1/r \ vr/r]$

The variables used in the convention are:

- az -- Azimuth angle (rad)
- el -- Elevation angle (rad)
- $azRate$ -- Azimuth rate (rad/s)
- $elRate$ -- Elevation rate (rad/s)
- ω -- $azRate \times \cos(el)$ (rad/s)
- $1/r$ -- $1/range$ (1/m)
- vr/r -- $range-rate/range$ or inverse time-to-go (1/s)

Data Types: `single` | `double`

vNoise — Target acceleration noise

vector

Target acceleration noise in scenario, specified as a vector of 2 or 3 elements.

Data Types: `double`

dt — Time difference

scalar

Time difference between the current state and the time at which the state is to be calculated, specified as a real finite numeric scalar.

Data Types: `single` | `double`

u — Observer input

vector | 2-D matrix | 3-D matrix

Observer input, specified as a vector or a matrix. The observer input can have the following impact on state-prediction based on its dimensions:

- When the number of elements in u equals the number of elements in `state`, the input u is assumed to be the maneuver performed by the observer during the time interval, dt . A maneuver is defined as motion of the observer higher than first order (or constant velocity).
- When the number of elements in u equals half the number of elements in `state`, the input u is assumed to be constant acceleration of the observer, specified in the scenario frame during the time interval, dt .

Data Types: `double`

Output Arguments

jacobianState — Jacobian of predicted state

matrix

Jacobian of the predicted state with respect to the previous state, returned as an n -by- n matrix, where n is the number of states in the state vector.

Data Types: `double`

jacobianNoise — Jacobian of predicted state

matrix

Jacobian of the predicted state with respect to the noise elements, returned as an n -by- m matrix. The variable n is the number of states in the state vector, and the variable m is the number of process noise terms. That is, $m = 2$ for state in 2-D space, and $m = 3$ for state in 3-D space.

For example, if the state vector is a 4-by-1 vector in a 2-D space, `vNoise` must be a 2-by-1 vector, and `jacobianNoise` is a 4-by-2 matrix.

If the state vector is a 6-by-1 vector in 3-D space, `vNoise` must be a 3-by-1 vector, and `jacobianNoise` is a 6-by-3 matrix.

Data Types: `double`

Extended Capabilities

C/C++ Code Generation

Generate C and C++ code using MATLAB® Coder™.

See Also

Objects

`trackingEKF`

Functions

`constvelmsc`

Introduced in R2018b

cvmeasmsc

Measurement based on constant velocity (CV) model in MSC frame

Syntax

```
measurement = cvmeasmsc(state)
measurement = cvmeasmsc(state, frame)
measurement = cvmeasmsc(state, frame, laxes)
measurement = cvmeasmsc(state, measurementParameters)
```

Description

`measurement = cvmeasmsc(state)` provides the angular measurement (azimuth and elevation) of the state in the sensor frame described by the `state`.

Tracking filters require a definition of the `MeasurementFcn` property. The `cvmeasmsc` function can be used as the `MeasurementFcn`. To use this `MeasurementFcn` with `trackerGNN` and `trackerTOMHT`, you can use the `trackingMSCEKF` filter.

`measurement = cvmeasmsc(state, frame)` provides the measurement in the frame specified. The allowed values for `frame` are 'rectangular' and 'spherical'.

`measurement = cvmeasmsc(state, frame, laxes)` specifies the axes of the sensor's coordinate system. The `laxes` input is a 3-by-3 matrix with each column specifying the direction of local `x`, `y` and `z` axes in the observer's Cartesian frame. The default for `laxes` is `[1 0 0;0 1 0;0 0 1]`.

`measurement = cvmeasmsc(state, measurementParameters)` specifies the measurement parameters as a scalar struct or an array of struct.

Examples

Obtain Measurements in MSC Frame

Using the `cvmeasmsc` function, you can obtain measurements of the state in the spherical and the rectangular frames.

Spherical Frame

Obtain the azimuth and elevation measurements from an MSC state.

```
mScState = [0.5;0;0.3;0;1e-3;1e-2];
cvmeasmsc(mScState)
```

```
ans = 2×1
    28.6479
    17.1887
```

Rectangular Frame

Obtain the position measurement from an MSC state. Specify the frame as a second input.

```
cvmeasmsc(mscState, 'rectangular')
```

```
ans = 3×1
      838.3866
      458.0127
      295.5202
```

Alternatively, you can specify the frame using `measurementParameters`.

```
cvmeasmsc(mscState, struct('Frame', 'rectangular'))
```

```
ans = 3×1
      838.3866
      458.0127
      295.5202
```

Input Arguments

state — Relative state

vector | matrix

State that is defined relative to an observer in modified spherical coordinates, specified as a vector or a 2-D matrix. For example, if there is a constant velocity target state, x_T , and a constant velocity observer state, x_O , then the `state` is defined as $x_T - x_O$ transformed in modified spherical coordinates.

The two-dimensional version of modified spherical coordinates (MSC) is also referred to as the modified polar coordinates (MPC). In the case of:

- 2-D space -- State is equal to $[az \ azRate \ 1/r \ vr/r]$.
- 3-D space -- State is equal to $[az \ \omega \ el \ elRate \ 1/r \ vr/r]$.

The variables used in the convention are:

- az -- Azimuth angle (rad)
- el -- Elevation angle (rad)
- $azRate$ -- Azimuth rate (rad/s)
- $elRate$ -- Elevation rate (rad/s)
- ω -- $azRate \times \cos(el)$ (rad/s)
- $1/r$ -- $1/range$ (1/m)
- vr/r -- $range-rate/range$ or inverse time-to-go (1/s)

If the input state is specified as a matrix, states must be concatenated along columns, where each column represents a state following the convention specified above. The output is a matrix with the same number of columns as the input, where each column represents the measurement from the corresponding state.

If the motion model is in 2-D space, values corresponding to elevation are assumed to be zero if elevation is requested as an output.

Data Types: single | double

frame — Measurement frame

'spherical' (default) | 'rectangular'

Measurement frame, specified as 'spherical' or 'rectangular'. If using the 'rectangular' frame, the three elements present in the measurement represent x, y, and z position of the target in the observer's Cartesian frame. If using the 'spherical' frame, the two elements present in the measurement represent azimuth and elevation measurement of the target. If not specified, the function provides the measurements in 'spherical' frame.

laxes — Direction of local axes

[1 0 0;0 1 0;0 0 1] (default) | 3-by-3 matrix

Direction of local x, y, and z axes in the scenario, specified as a 3-by-3 matrix. If not specified, laxes is equal to [1 0 0;0 1 0;0 0 1].

Data Types: double

measurementParameters — Measurement parameters

structure | array of structure

Measurement parameters, specified as a structure or an array of structures. The fields of the structure are:

Field	Description	Example
Frame	Frame used to report measurements, specified as one of these values: <ul style="list-style-type: none"> 'rectangular' — Detections are reported in rectangular coordinates. 'spherical' — Detections are reported in spherical coordinates. 	'spherical'
OriginPosition	Position offset of the origin of the frame relative to the parent frame, specified as an [x y z] real-valued vector.	[0 0 0]
OriginVelocity	Velocity offset of the origin of the frame relative to the parent frame, specified as a [vx vy vz] real-valued vector.	[0 0 0]
Orientation	Frame rotation matrix, specified as a 3-by-3 real-valued orthonormal matrix.	[1 0 0; 0 1 0; 0 0 1]

Field	Description	Example
HasAzimuth	Logical scalar indicating if azimuth is included in the measurement.	1
HasElevation	Logical scalar indicating if elevation is included in the measurement. For measurements reported in a rectangular frame, and if HasElevation is false, the reported measurements assume 0 degrees of elevation.	1
HasRange	Logical scalar indicating if range is included in the measurement.	1
HasVelocity	Logical scalar indicating if the reported detections include velocity measurements. For measurements reported in the rectangular frame, if HasVelocity is false, the measurements are reported as [x y z]. If HasVelocity is true, measurements are reported as [x y z vx vy vz].	1
IsParentToChild	Logical scalar indicating if Orientation performs a frame rotation from the parent coordinate frame to the child coordinate frame. When IsParentToChild is false, then Orientation performs a frame rotation from the child coordinate frame to the parent coordinate frame.	0

If you only want to perform one coordinate transformation, such as a transformation from the body frame to the sensor frame, you only need to specify a measurement parameter structure. If you want to perform multiple coordinate transformations, you need to specify an array of measurement parameter structures. To learn how to perform multiple transformations, see the “Convert Detections to objectDetection Format” example.

Data Types: struct

Output Arguments

measurement — Measurement from MSC state

vector

Target measurement in MSC frame, returned as a:

- One-element vector -- When HasElevation is set to false, the vector contains azimuth as the only measurement.
- Two-element vector -- When the frame is set to 'spherical', the function measures the azimuth and elevation measurements from an MSC state.
- Three-element vector -- When the frame is set to 'rectangular', the function measures the position measurement from an MSC state.

Extended Capabilities

C/C++ Code Generation

Generate C and C++ code using MATLAB® Coder™.

See Also

Objects

trackingMSCEKF

Functions

constvelmsc | cvmeasmscjac | initcvmscekf

Introduced in R2018b

cvmeasmscjac

Jacobian of measurement using constant velocity (CV) model in MSC frame

Syntax

```
jacobian = cvmeasmscjac(state)
jacobian = cvmeasmscjac(state, frame)
jacobian = cvmeasmscjac(state, frame, laxes)
jacobian = cvmeasmscjac(state, measurementParameters)
```

Description

`jacobian = cvmeasmscjac(state)` calculates the Jacobian with respect to angular measurement (azimuth and elevation) of the state in the sensor frame. The motion can be either in 2-D or 3-D space. If motion model is in 2-D space, values corresponding to elevation are assumed to be zero.

The `trackingEKF` and `trackingMSCEKF` filters require a definition of the `MeasurementJacobianFcn` property. The `cvmeasmscjac` function can be used as the `MeasurementJacobianFcn`. To use this `MeasurementFcn` with `trackerGNN` and `trackerTOMHT`, you can use the `trackingMSCEKF` filter.

`jacobian = cvmeasmscjac(state, frame)` provides the Jacobian measurement in the frame specified. The allowed values for `frame` are `'rectangular'` and `'spherical'`.

`jacobian = cvmeasmscjac(state, frame, laxes)` specifies the axes of the sensor's coordinate system. The `laxes` input is a 3-by-3 matrix with each column specifying the direction of local x , y , and z axes in the sensor coordinate system. The default for `laxes` is `[1 0 0; 0 1 0; 0 0 1]`.

`jacobian = cvmeasmscjac(state, measurementParameters)` specifies the measurement parameters as a struct.

Examples

Obtain Jacobian of State Measurements in MSC Frame

Using the `cvmeasmscjac` function, you can obtain the jacobian of the state measurements in the spherical and the rectangular frames.

Spherical Frame

Obtain the Jacobian of the azimuth and elevation measurements from an MSC state.

```
mscState = [0.5;0;0.3;0;1e-3;1e-2];
jacobian = cvmeasmscjac(mscState)
```

```
ans = 2x6
```

```
    57.2958         0         0         0         0         0
         0         0    57.2958         0         0         0
```

Rectangular Frame

Obtain the Jacobian of the position measurement from an MSC state. Specify the frame as a second input.

```
cvmeasmscjac(mscState, 'rectangular')
```

```
ans = 3×6
105 ×

    -0.0046         0    -0.0026         0    -8.3839         0
     0.0084         0    -0.0014         0    -4.5801         0
           0         0     0.0096         0    -2.9552         0
```

Alternatively, you can specify the frame using `measurementParameters`.

```
cvmeasmscjac(mscState, struct('Frame', 'rectangular'))
```

```
ans = 3×6
105 ×

    -0.0046         0    -0.0026         0    -8.3839         0
     0.0084         0    -0.0014         0    -4.5801         0
           0         0     0.0096         0    -2.9552         0
```

Input Arguments

state — Relative state

vector

State that is defined relative to an observer in modified spherical coordinates, as a vector. For example, if there is a target state, xT , and an observer state, xO , the `state` used by the function is $xT - xO$.

The 2-D version of modified spherical coordinates (MSC) is also referred to as the modified polar coordinates (MPC). In the case of:

- 2-D space -- State equals [az $azRate$ $1/r$ vr/r].
- 3-D space -- State equals [az $omega$ el $elRate$ $1/r$ vr/r].

The variables used in the convention are:

- az -- Azimuth angle (rad)
- el -- Elevation angle (rad)
- $azRate$ -- Azimuth rate (rad/s)
- $elRate$ -- Elevation rate (rad/s)
- $omega$ -- $azRate \times \cos(el)$ (rad/s)
- $1/r$ -- $1/range$ (1/m)
- vr/r -- $range-rate/range$ or inverse time-to-go (1/s)

If the motion model is in 2-D space, values corresponding to elevation are assumed to be zero if elevation is requested as an output.

Data Types: single | double

frame — Measurement frame

'spherical' (default) | 'rectangular'

Measurement frame, specified as 'spherical' or 'rectangular'. If using the 'rectangular' frame, the three rows present in `jacobian` represent the Jacobian of the measurements with respect to x , y , and z position of the target in the sensor's Cartesian frame. If using the 'spherical' frame, the two rows present in `jacobian` represent the Jacobian of the azimuth and elevation measurements of the target. If not specified, the function provides the Jacobian of the measurements in the 'spherical' frame.

laxes — Direction of local axes

[1 0 0;0 1 0;0 0 1] (default) | 3-by-3 matrix

Direction of local x , y , and z axes in the scenario, specified as a 3-by-3 matrix. Each column of the matrix specifies the direction of the local x , y , and z axes in the sensor coordinate system. If not specified, the `laxes` is equal to [1 0 0;0 1 0;0 0 1].

Data Types: double

measurementParameters — Measurement parameters

structure | array of structure

Measurement parameters, specified as a structure or an array of structures. The fields of the structure are:

Field	Description	Example
Frame	Frame used to report measurements, specified as one of these values: <ul style="list-style-type: none"> 'rectangular' — Detections are reported in rectangular coordinates. 'spherical' — Detections are reported in spherical coordinates. 	'spherical'
OriginPosition	Position offset of the origin of the frame relative to the parent frame, specified as an [x y z] real-valued vector.	[0 0 0]
OriginVelocity	Velocity offset of the origin of the frame relative to the parent frame, specified as a [vx vy vz] real-valued vector.	[0 0 0]
Orientation	Frame rotation matrix, specified as a 3-by-3 real-valued orthonormal matrix.	[1 0 0; 0 1 0; 0 0 1]

Field	Description	Example
HasAzimuth	Logical scalar indicating if azimuth is included in the measurement.	1
HasElevation	Logical scalar indicating if elevation is included in the measurement. For measurements reported in a rectangular frame, and if HasElevation is false, the reported measurements assume 0 degrees of elevation.	1
HasRange	Logical scalar indicating if range is included in the measurement.	1
HasVelocity	Logical scalar indicating if the reported detections include velocity measurements. For measurements reported in the rectangular frame, if HasVelocity is false, the measurements are reported as [x y z]. If HasVelocity is true, measurements are reported as [x y z vx vy vz].	1
IsParentToChild	Logical scalar indicating if Orientation performs a frame rotation from the parent coordinate frame to the child coordinate frame. When IsParentToChild is false, then Orientation performs a frame rotation from the child coordinate frame to the parent coordinate frame.	0

If you only want to perform one coordinate transformation, such as a transformation from the body frame to the sensor frame, you only need to specify a measurement parameter structure. If you want to perform multiple coordinate transformations, you need to specify an array of measurement parameter structures. To learn how to perform multiple transformations, see the “Convert Detections to objectDetection Format” example.

Data Types: struct

Output Arguments

jacobian — Measurement from MSC state matrix

Target measurement in MSC frame, returned as a:

- One-row matrix -- When `HasElevation` is set to `false`.
- Two-row matrix -- When the `frame` is set to `'spherical'`, the function measures the azimuth and elevation measurements from a MSC state.
- Three-row matrix -- When the `frame` is set to `'rectangular'`, the function measures the position measurement from a MSC state.

Extended Capabilities

C/C++ Code Generation

Generate C and C++ code using MATLAB® Coder™.

See Also

Objects

`trackingMSCEKF`

Functions

`constvelmsc` | `cvmeasmsc` | `initcvmscekf`

Introduced in R2018b

cameas

Measurement function for constant-acceleration motion

Syntax

```
measurement = cameas(state)
measurement = cameas(state, frame)
measurement = cameas(state, frame, sensorpos)
measurement = cameas(state, frame, sensorpos, sensorvel)
measurement = cameas(state, frame, sensorpos, sensorvel, laxes)
measurement = cameas(state, measurementParameters)
```

Description

`measurement = cameas(state)` returns the measurement, for the constant-acceleration Kalman filter motion model in rectangular coordinates. The `state` argument specifies the current state of the filter.

`measurement = cameas(state, frame)` also specifies the measurement coordinate system, `frame`.

`measurement = cameas(state, frame, sensorpos)` also specifies the sensor position, `sensorpos`.

`measurement = cameas(state, frame, sensorpos, sensorvel)` also specifies the sensor velocity, `sensorvel`.

`measurement = cameas(state, frame, sensorpos, sensorvel, laxes)` also specifies the local sensor axes orientation, `laxes`.

`measurement = cameas(state, measurementParameters)` specifies the measurement parameters, `measurementParameters`.

Examples

Create Measurement from Accelerating Object in Rectangular Frame

Define the state of an object in 2-D constant-acceleration motion. The state is the position, velocity, and acceleration in both dimensions. The measurements are in rectangular coordinates.

```
state = [1,10,3,2,20,0.5].';
measurement = cameas(state)
```

```
measurement = 3×1
```

```
1
2
0
```

The measurement is returned in three-dimensions with the z-component set to zero.

Create Measurement from Accelerating Object in Spherical Frame

Define the state of an object in 2-D constant-acceleration motion. The state is the position, velocity, and acceleration in both dimensions. The measurements are in spherical coordinates.

```
state = [1,10,3,2,20,5].';
measurement = cameas(state, 'spherical')
```

```
measurement = 4×1
```

```
63.4349
    0
  2.2361
 22.3607
```

The elevation of the measurement is zero and the range rate is positive. These results indicate that the object is moving away from the sensor.

Create Measurement from Accelerating Object in Translated Spherical Frame

Define the state of an object moving in 2-D constant-acceleration motion. The state consists of position, velocity, and acceleration in each dimension. The measurements are in spherical coordinates with respect to a frame located at (20;40;0) meters from the origin.

```
state = [1,10,3,2,20,5].';
measurement = cameas(state, 'spherical', [20;40;0])
```

```
measurement = 4×1
```

```
-116.5651
    0
  42.4853
 -22.3607
```

The elevation of the measurement is zero and the range rate is negative indicating that the object is moving toward the sensor.

Create Measurement from Constant-Accelerating Object Using Measurement Parameters

Define the state of an object moving in 2-D constant-acceleration motion. The state consists of position, velocity, and acceleration in each dimension. The measurements are in spherical coordinates with respect to a frame located at (20;40;0) meters from the origin.

```
state2d = [1,10,3,2,20,5].';
```

The elevation of the measurement is zero and the range rate is negative indicating that the object is moving toward the sensor.

```
frame = 'spherical';
sensorpos = [20;40;0];
sensorvel = [0;5;0];
laxes = eye(3);
measurement = cameas(state2d, 'spherical', sensorpos, sensorvel, laxes)
```

```
measurement = 4×1
```

```
-116.5651
      0
  42.4853
 -17.8885
```

The elevation of the measurement is zero and the range rate is negative. These results indicate that the object is moving toward the sensor.

Put the measurement parameters in a structure and use the alternative syntax.

```
measparm = struct('Frame', frame, 'OriginPosition', sensorpos, 'OriginVelocity', sensorvel, ...
    'Orientation', laxes);
measurement = cameas(state2d, measparm)
```

```
measurement = 4×1
```

```
-116.5651
      0
  42.4853
 -17.8885
```

Input Arguments

state — Kalman filter state vector

real-valued $3N$ -element vector

Kalman filter state vector for constant-acceleration motion, specified as a real-valued $3N$ -element vector. N is the number of spatial degrees of freedom of motion. For each spatial degree of motion, the state vector takes the form shown in this table.

Spatial Dimensions	State Vector Structure
1-D	[x; vx; ax]
2-D	[x; vx; ax; y; vy; ay]
3-D	[x; vx; ax; y; vy; ay; z; vz; az]

For example, x represents the x -coordinate, v_x represents the velocity in the x -direction, and a_x represents the acceleration in the x -direction. If the motion model is in one-dimensional space, the y - and z -axes are assumed to be zero. If the motion model is in two-dimensional space, values along the z -axis are assumed to be zero. Position coordinates are in meters. Velocity coordinates are in meters/second. Acceleration coordinates are in meters/second².

Example: [5;0.1;0.01;0;-0.2;-0.01;-3;0.05;0]

Data Types: double

frame — Measurement output frame

'rectangular' (default) | 'spherical'

Measurement output frame, specified as 'rectangular' or 'spherical'. When the frame is 'rectangular', a measurement consists of x , y , and z Cartesian coordinates. When specified as 'spherical', a measurement consists of azimuth, elevation, range, and range rate.

Data Types: char

sensorpos — Sensor position

[0;0;0] (default) | real-valued 3-by-1 column vector

Sensor position with respect to the navigation frame, specified as a real-valued 3-by-1 column vector. Units are in meters.

Data Types: double

sensorvel — Sensor velocity

[0;0;0] (default) | real-valued 3-by-1 column vector

Sensor velocity with respect to the navigation frame, specified as a real-valued 3-by-1 column vector. Units are in m/s.

Data Types: double

laxes — Local sensor coordinate axes

[1,0,0;0,1,0;0,0,1] (default) | 3-by-3 orthogonal matrix

Local sensor coordinate axes, specified as a 3-by-3 orthogonal matrix. Each column specifies the direction of the local x -, y -, and z -axes, respectively, with respect to the navigation frame. That is, the matrix is the rotation matrix from the global frame to the sensor frame.

Data Types: double

measurementParameters — Measurement parameters

structure | array of structure

Measurement parameters, specified as a structure or an array of structures. The fields of the structure are:

Field	Description	Example
Frame	<p>Frame used to report measurements, specified as one of these values:</p> <ul style="list-style-type: none"> 'rectangular' — Detections are reported in rectangular coordinates. 'spherical' — Detections are reported in spherical coordinates. 	'spherical'

Field	Description	Example
OriginPosition	Position offset of the origin of the frame relative to the parent frame, specified as an [x y z] real-valued vector.	[0 0 0]
OriginVelocity	Velocity offset of the origin of the frame relative to the parent frame, specified as a [vx vy vz] real-valued vector.	[0 0 0]
Orientation	Frame rotation matrix, specified as a 3-by-3 real-valued orthonormal matrix.	[1 0 0; 0 1 0; 0 0 1]
HasAzimuth	Logical scalar indicating if azimuth is included in the measurement.	1
HasElevation	Logical scalar indicating if elevation is included in the measurement. For measurements reported in a rectangular frame, and if HasElevation is false, the reported measurements assume 0 degrees of elevation.	1
HasRange	Logical scalar indicating if range is included in the measurement.	1
HasVelocity	Logical scalar indicating if the reported detections include velocity measurements. For measurements reported in the rectangular frame, if HasVelocity is false, the measurements are reported as [x y z]. If HasVelocity is true, measurements are reported as [x y z vx vy vz].	1
IsParentToChild	Logical scalar indicating if Orientation performs a frame rotation from the parent coordinate frame to the child coordinate frame. When IsParentToChild is false, then Orientation performs a frame rotation from the child coordinate frame to the parent coordinate frame.	0

If you only want to perform one coordinate transformation, such as a transformation from the body frame to the sensor frame, you only need to specify a measurement parameter structure. If you want to perform multiple coordinate transformations, you need to specify an array of measurement parameter structures. To learn how to perform multiple transformations, see the “Convert Detections to objectDetection Format” example.

Data Types: `struct`

Output Arguments

measurement — Measurement vector

N-by-1 column vector

Measurement vector, returned as an *N*-by-1 column vector. The form of the measurement depends upon which syntax you use.

- When the syntax does not use the `measurementParameters` argument, the measurement vector is `[x,y,z]` when the `frame` input argument is set to `'rectangular'` and `[az;el;r;rr]` when the `frame` is set to `'spherical'`.
- When the syntax uses the `measurementParameters` argument, the size of the measurement vector depends on the values of the `frame`, `HasVelocity`, and `HasElevation` fields in the `measurementParameters` structure.

frame	measurement															
'spherical'	<p>Specifies the azimuth angle, <i>az</i>, elevation angle, <i>el</i>, range, <i>r</i>, and range rate, <i>rr</i>, of the object with respect to the local ego vehicle coordinate system. Positive values for range rate indicate that an object is moving away from the sensor.</p> <p>Spherical measurements</p> <table border="1"> <thead> <tr> <th></th> <th></th> <th colspan="2">HasElevation</th> </tr> </thead> <tbody> <tr> <td></td> <td></td> <td>false</td> <td>true</td> </tr> <tr> <td rowspan="2">HasVelocity</td> <td>false</td> <td>[az;r]</td> <td>[az;el;r]</td> </tr> <tr> <td>true</td> <td>[az;r;rr]</td> <td>[az;el;r;rr]</td> </tr> </tbody> </table> <p>Angle units are in degrees, range units are in meters, and range rate units are in m/s.</p>			HasElevation				false	true	HasVelocity	false	[az;r]	[az;el;r]	true	[az;r;rr]	[az;el;r;rr]
		HasElevation														
		false	true													
HasVelocity	false	[az;r]	[az;el;r]													
	true	[az;r;rr]	[az;el;r;rr]													

frame	measurement	
'rectangular'	Specifies the Cartesian position and velocity coordinates of the tracked object with respect to the ego vehicle coordinate system.	
	Rectangular measurements	
	HasVelocity	false true
Position units are in meters and velocity units are in m/s.		

Data Types: double

More About

Azimuth and Elevation Angle Definitions

Define the azimuth and elevation angles used in the toolbox.

The azimuth angle of a vector is the angle between the x-axis and its orthogonal projection onto the xy plane. The angle is positive in going from the x axis toward the y axis. Azimuth angles lie between -180 and 180 degrees. The elevation angle is the angle between the vector and its orthogonal projection onto the xy-plane. The angle is positive when going toward the positive z-axis from the xy plane.

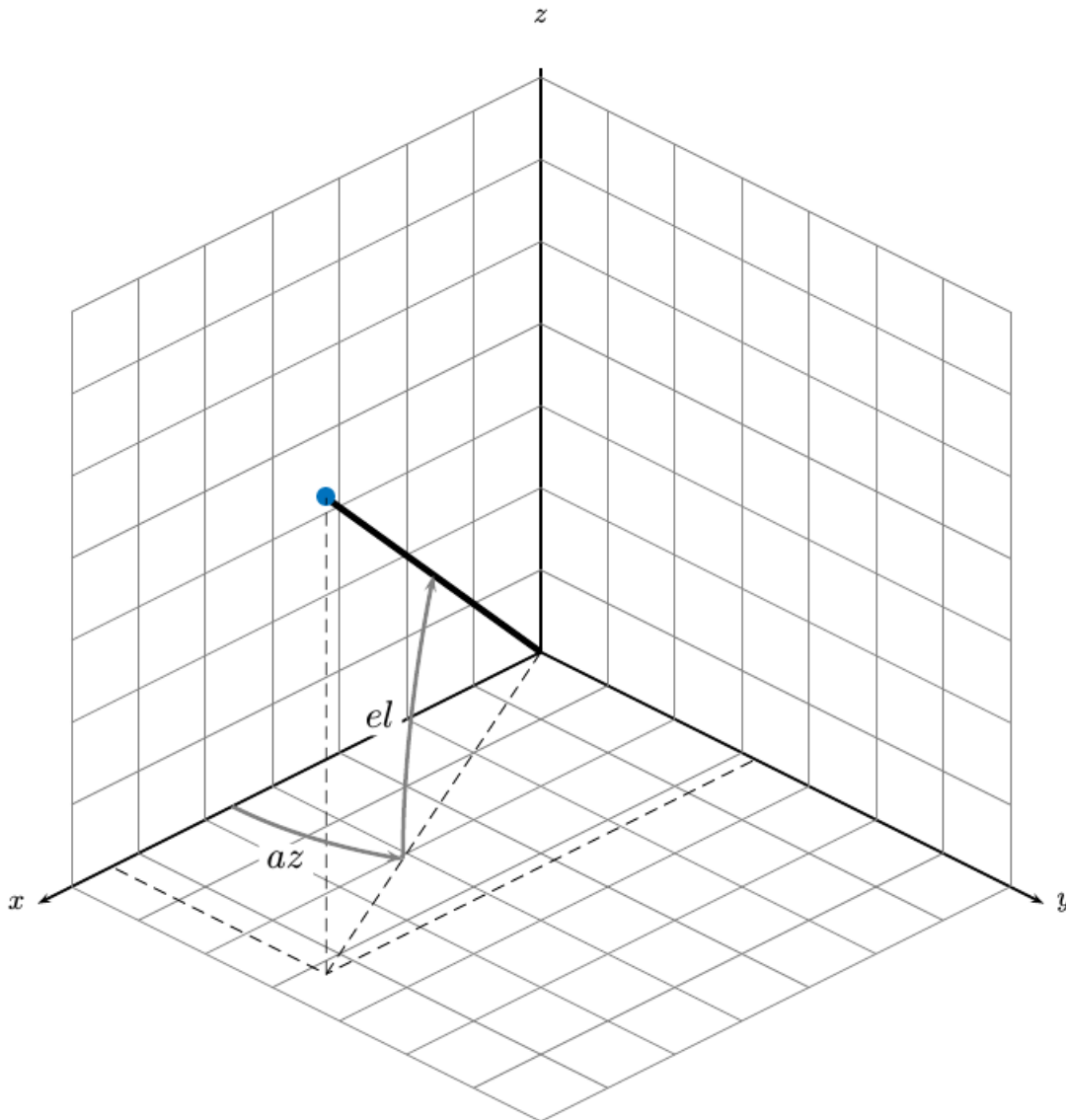

Extended Capabilities

C/C++ Code Generation

Generate C and C++ code using MATLAB® Coder™.

See Also

Functions

cameasjac | constacc | constaccjac | constturn | constturnjac | constvel | constveljac | ctmeas | ctmeasjac | cvmeas | cvmeasjac

Objects

trackingCKF | trackingEKF | trackingKF | trackingMSCEKF | trackingPF | trackingUKF

Introduced in R2018b

cameasjac

Jacobian of measurement function for constant-acceleration motion

Syntax

```
measurementjac = cameasjac(state)
measurementjac = cameasjac(state, frame)
measurementjac = cameasjac(state, frame, sensorpos)
measurementjac = cameasjac(state, frame, sensorpos, sensorvel)
measurementjac = cameasjac(state, frame, sensorpos, sensorvel, laxes)
measurementjac = cameasjac(state, measurementParameters)
```

Description

`measurementjac = cameasjac(state)` returns the measurement Jacobian, for constant-acceleration Kalman filter motion model in rectangular coordinates. The `state` argument specifies the current state of the filter.

`measurementjac = cameasjac(state, frame)` also specifies the measurement coordinate system, `frame`.

`measurementjac = cameasjac(state, frame, sensorpos)` also specifies the sensor position, `sensorpos`.

`measurementjac = cameasjac(state, frame, sensorpos, sensorvel)` also specifies the sensor velocity, `sensorvel`.

`measurementjac = cameasjac(state, frame, sensorpos, sensorvel, laxes)` also specifies the local sensor axes orientation, `laxes`.

`measurementjac = cameasjac(state, measurementParameters)` specifies the measurement parameters, `measurementParameters`.

Examples

Measurement Jacobian of Accelerating Object in Rectangular Frame

Define the state of an object in 2-D constant-acceleration motion. The state is the position, velocity, and acceleration in both dimensions. Construct the measurement Jacobian in rectangular coordinates.

```
state = [1,10,3,2,20,5].';
jacobian = cameasjac(state)
```

```
jacobian = 3×6
```

```

     1     0     0     0     0     0
     0     0     0     1     0     0
     0     0     0     0     0     0
```

Measurement Jacobian of Accelerating Object in Spherical Frame

Define the state of an object in 2-D constant-acceleration motion. The state is the position, velocity, and acceleration in both dimensions. Compute the measurement Jacobian in spherical coordinates.

```
state = [1;10;3;2;20;5];
measurementjac = cameasjac(state, 'spherical')
```

```
measurementjac = 4×6
```

```
-22.9183      0      0      11.4592      0      0
      0      0      0      0      0      0
      0.4472      0      0      0.8944      0      0
      0.0000      0.4472      0      0.0000      0.8944      0
```

Measurement Jacobian of Accelerating Object in Translated Spherical Frame

Define the state of an object in 2-D constant-acceleration motion. The state is the position, velocity, and acceleration in both dimensions. Compute the measurement Jacobian in spherical coordinates with respect to an origin at (5;-20;0) meters.

```
state = [1,10,3,2,20,5].';
sensorpos = [5,-20,0].';
measurementjac = cameasjac(state, 'spherical', sensorpos)
```

```
measurementjac = 4×6
```

```
-2.5210      0      0     -0.4584      0      0
      0      0      0      0      0      0
-0.1789      0      0      0.9839      0      0
      0.5903     -0.1789      0      0.1073      0.9839      0
```

Create Measurement Jacobian of Accelerating Object Using Measurement Parameters

Define the state of an object in 2-D constant-acceleration motion. The state is the position, velocity, and acceleration in both dimensions. Compute the measurement Jacobian in spherical coordinates with respect to an origin at (5;-20;0) meters.

```
state2d = [1,10,3,2,20,5].';
sensorpos = [5,-20,0].';
frame = 'spherical';
sensorvel = [0;8;0];
laxes = eye(3);
measurementjac = cameasjac(state2d, frame, sensorpos, sensorvel, laxes)
```

```
measurementjac = 4×6
```

```
-2.5210      0      0     -0.4584      0      0
```

```

      0      0      0      0      0      0
-0.1789    0      0      0.9839    0      0
 0.5274  -0.1789    0      0.0959    0.9839    0

```

Put the measurement parameters in a structure and use the alternative syntax.

```

measparm = struct('Frame',frame,'OriginPosition',sensorpos,'OriginVelocity',sensorvel, ...
    'Orientation',axes);
measurementjac = cameasjac(state2d,measparm)

```

```

measurementjac = 4x6

```

```

-2.5210    0      0      -0.4584    0      0
      0      0      0      0      0      0
-0.1789    0      0      0.9839    0      0
 0.5274  -0.1789    0      0.0959    0.9839    0

```

Input Arguments

state — Kalman filter state vector

real-valued $3N$ -element vector

Kalman filter state vector for constant-acceleration motion, specified as a real-valued $3N$ -element vector. N is the number of spatial degrees of freedom of motion. For each spatial degree of motion, the state vector takes the form shown in this table.

Spatial Dimensions	State Vector Structure
1-D	[x;vx;ax]
2-D	[x;vx;ax;y;vy;ay]
3-D	[x;vx;ax;y;vy;ay;z;vz;az]

For example, x represents the x -coordinate, v_x represents the velocity in the x -direction, and a_x represents the acceleration in the x -direction. If the motion model is in one-dimensional space, the y - and z -axes are assumed to be zero. If the motion model is in two-dimensional space, values along the z -axis are assumed to be zero. Position coordinates are in meters. Velocity coordinates are in meters/second. Acceleration coordinates are in meters/second².

Example: [5;0.1;0.01;0;-0.2;-0.01;-3;0.05;0]

Data Types: double

frame — Measurement output frame

'rectangular' (default) | 'spherical'

Measurement output frame, specified as 'rectangular' or 'spherical'. When the frame is 'rectangular', a measurement consists of x , y , and z Cartesian coordinates. When specified as 'spherical', a measurement consists of azimuth, elevation, range, and range rate.

Data Types: char

sensorpos — Sensor position

[0;0;0] (default) | real-valued 3-by-1 column vector

Sensor position with respect to the navigation frame, specified as a real-valued 3-by-1 column vector. Units are in meters.

Data Types: double

sensorvel — Sensor velocity

[0;0;0] (default) | real-valued 3-by-1 column vector

Sensor velocity with respect to the navigation frame, specified as a real-valued 3-by-1 column vector. Units are in m/s.

Data Types: double

laxes — Local sensor coordinate axes

[1,0,0;0,1,0;0,0,1] (default) | 3-by-3 orthogonal matrix

Local sensor coordinate axes, specified as a 3-by-3 orthogonal matrix. Each column specifies the direction of the local x-, y-, and z-axes, respectively, with respect to the navigation frame. That is, the matrix is the rotation matrix from the global frame to the sensor frame.

Data Types: double

measurementParameters — Measurement parameters

structure | array of structure

Measurement parameters, specified as a structure or an array of structures. The fields of the structure are:

Field	Description	Example
Frame	Frame used to report measurements, specified as one of these values: <ul style="list-style-type: none"> 'rectangular' — Detections are reported in rectangular coordinates. 'spherical' — Detections are reported in spherical coordinates. 	'spherical'
OriginPosition	Position offset of the origin of the frame relative to the parent frame, specified as an [x y z] real-valued vector.	[0 0 0]
OriginVelocity	Velocity offset of the origin of the frame relative to the parent frame, specified as a [vx vy vz] real-valued vector.	[0 0 0]
Orientation	Frame rotation matrix, specified as a 3-by-3 real-valued orthonormal matrix.	[1 0 0; 0 1 0; 0 0 1]

Field	Description	Example
HasAzimuth	Logical scalar indicating if azimuth is included in the measurement.	1
HasElevation	Logical scalar indicating if elevation is included in the measurement. For measurements reported in a rectangular frame, and if <code>HasElevation</code> is false, the reported measurements assume 0 degrees of elevation.	1
HasRange	Logical scalar indicating if range is included in the measurement.	1
HasVelocity	Logical scalar indicating if the reported detections include velocity measurements. For measurements reported in the rectangular frame, if <code>HasVelocity</code> is false, the measurements are reported as <code>[x y z]</code> . If <code>HasVelocity</code> is true, measurements are reported as <code>[x y z vx vy vz]</code> .	1
IsParentToChild	Logical scalar indicating if <code>Orientation</code> performs a frame rotation from the parent coordinate frame to the child coordinate frame. When <code>IsParentToChild</code> is false, then <code>Orientation</code> performs a frame rotation from the child coordinate frame to the parent coordinate frame.	0

If you only want to perform one coordinate transformation, such as a transformation from the body frame to the sensor frame, you only need to specify a measurement parameter structure. If you want to perform multiple coordinate transformations, you need to specify an array of measurement parameter structures. To learn how to perform multiple transformations, see the “Convert Detections to objectDetection Format” example.

Data Types: `struct`

Output Arguments

`measurementjac` — Measurement Jacobian

real-valued 3-by- N matrix | real-valued 4-by- N matrix

Measurement Jacobian, specified as a real-valued 3-by- N or 4-by- N matrix. N is the dimension of the state vector. The interpretation of the rows and columns depends on the `frame` argument, as described in this table.

Frame	Measurement Jacobian
'rectangular'	Jacobian of the measurements $[x; y; z]$ with respect to the state vector. The measurement vector is with respect to the local coordinate system. Coordinates are in meters.
'spherical'	Jacobian of the measurement vector $[az; el; r; rr]$ with respect to the state vector. Measurement vector components specify the azimuth angle, elevation angle, range, and range rate of the object with respect to the local sensor coordinate system. Angle units are in degrees. Range units are in meters and range rate units are in meters/second.

More About

Azimuth and Elevation Angle Definitions

Define the azimuth and elevation angles used in the toolbox.

The azimuth angle of a vector is the angle between the x -axis and its orthogonal projection onto the xy plane. The angle is positive in going from the x axis toward the y axis. Azimuth angles lie between -180 and 180 degrees. The elevation angle is the angle between the vector and its orthogonal projection onto the xy -plane. The angle is positive when going toward the positive z -axis from the xy plane.

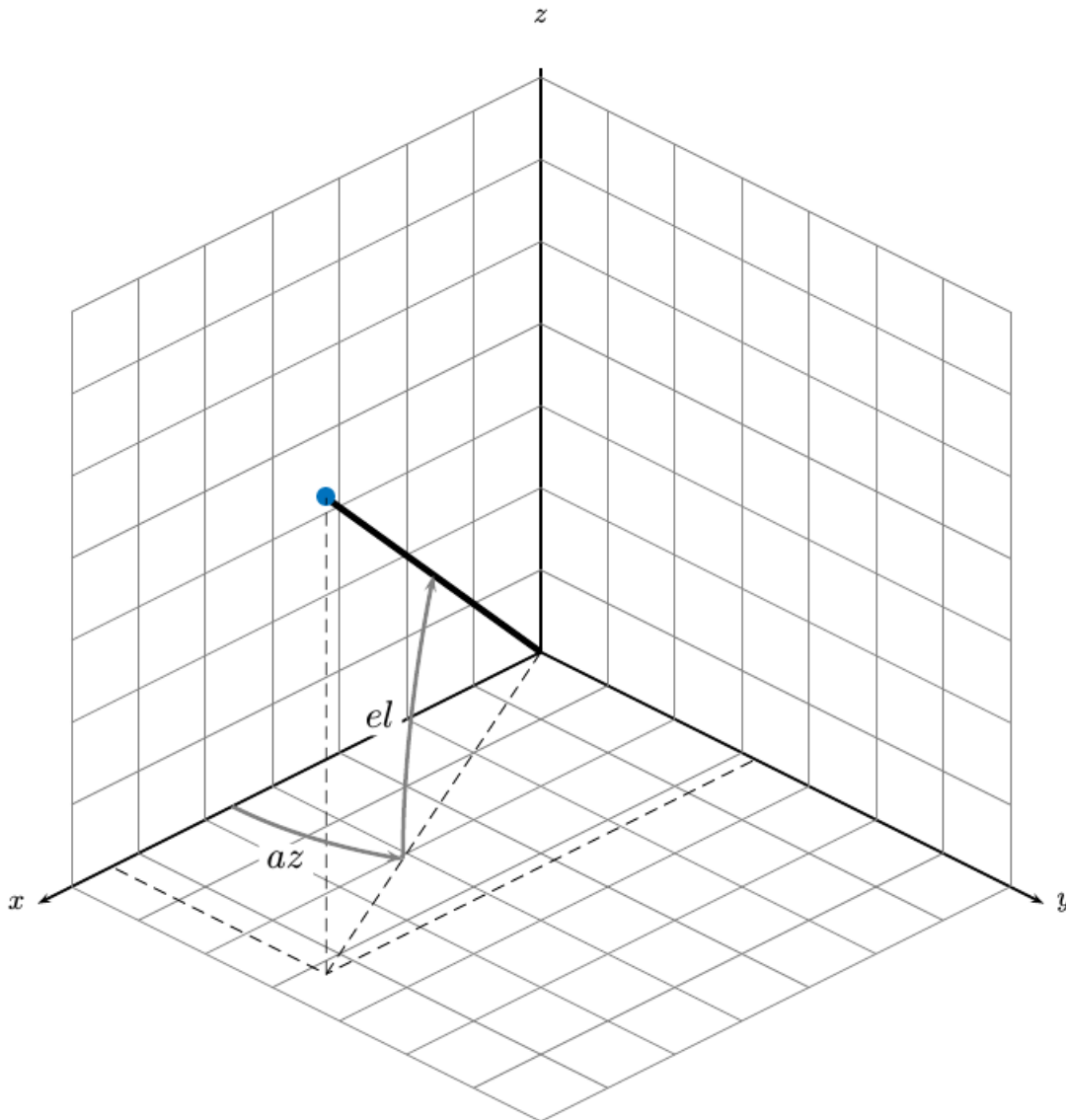

Extended Capabilities

C/C++ Code Generation

Generate C and C++ code using MATLAB® Coder™.

See Also

Functions

cameas | constacc | constaccjac | constturn | constturnjac | constvel | constveljac | ctmeas | ctmeasjac | cvmeas | cvmeasjac

Objects

trackingCKF | trackingEKF | trackingKF | trackingMSCEKF | trackingPF | trackingUKF

Introduced in R2018b

constturn

Constant turn-rate motion model

Syntax

```
updatedstate = constturn(state)
updatedstate = constturn(state,dt)
updatedstate = constturn(state,w,dt)
```

Description

`updatedstate = constturn(state)` returns the updated state, `updatedstate`, obtained from the previous state, `state`, after a one-second step time for motion modelled as constant turn rate. Constant turn rate means that motion in the x-y plane follows a constant angular velocity and motion in the vertical z directions follows a constant velocity model.

`updatedstate = constturn(state,dt)` also specifies the time step, `dt`.

`updatedstate = constturn(state,w,dt)` also specifies noise, `w`.

Examples

Update State for Constant Turn-Rate Motion

Define an initial state for 2-D constant turn-rate motion. The turn rate is 12 degrees per second. Update the state to one second later.

```
state = [500,0,0,100,12].';
state = constturn(state)
```

```
state = 5×1
```

```
489.5662
-20.7912
 99.2705
 97.8148
 12.0000
```

Update State for Constant Turn-Rate Motion with Specified Time Step

Define an initial state for 2-D constant turn-rate motion. The turn rate is 12 degrees per second. Update the state to 0.1 seconds later.

```
state = [500,0,0,100,12].';
state = constturn(state,0.1)
```

```
state = 5×1
```

```

499.8953
-2.0942
 9.9993
99.9781
12.0000

```

Input Arguments

state — State vector

real-valued 5-element vector | real-valued 7-element vector | 5-by- N real-valued matrix | 7-by- N real-valued matrix

State vector for a constant turn-rate motion model in two or three spatial dimensions, specified as a real-valued vector or matrix.

- When specified as a 5-element vector, the state vector describes 2-D motion in the x - y plane. You can specify the state vector as a row or column vector. The components of the state vector are $[x; vx; y; vy; \omega]$ where x represents the x -coordinate and vx represents the velocity in the x -direction. y represents the y -coordinate and vy represents the velocity in the y -direction. ω represents the turn rate.

When specified as a 5-by- N matrix, each column represents a different state vector. N represents the number of states.

- When specified as a 7-element vector, the state vector describes 3-D motion. You can specify the state vector as a row or column vector. The components of the state vector are $[x; vx; y; vy; \omega; z; vz]$ where x represents the x -coordinate and vx represents the velocity in the x -direction. y represents the y -coordinate and vy represents the velocity in the y -direction. ω represents the turn rate. z represents the z -coordinate and vz represents the velocity in the z -direction.

When specified as a 7-by- N matrix, each column represents a different state vector. N represents the number of states.

Position coordinates are in meters. Velocity coordinates are in meters/second. Turn rate is in degrees/second.

Example: `[5;0.1;4;-0.2;0.01]`

Data Types: `double`

dt — Time step interval of filter

1.0 (default) | positive scalar

Time step interval of filter, specified as a positive scalar. Time units are in seconds.

Example: `0.5`

Data Types: `single` | `double`

w — State noise

scalar | real-valued $(D+1)$ -by- N matrix

State noise, specified as a scalar or real-valued $(D+1)$ -length -by- N matrix. D is the number of motion dimensions and N is the number of state vectors. The components are each columns are

[ax;ay;alpha] for 2-D motion or [ax;ay;alpha;az] for 3-D motion. ax, ay, and az are the linear acceleration noise values in the x-, y-, and z-axes, respectively, and alpha is the angular acceleration noise value. If specified as a scalar, the value expands to a $(D+1)$ -by- N matrix.

Data Types: single | double

Output Arguments

updatedstate — Updated state vector

real-valued column or row vector | real-valued matrix

Updated state vector, returned as a real-valued vector or real-valued matrix with same number of elements and dimensions as the input state vector.

Extended Capabilities

C/C++ Code Generation

Generate C and C++ code using MATLAB® Coder™.

See Also

Functions

cameas | cameasjac | constacc | constaccjac | constturnjac | constvel | constveljac | ctmeas | ctmeasjac | cvmeas | cvmeasjac | initctekf | initctukf

Objects

trackingEKF | trackingUKF

Introduced in R2018b

constturnjac

Jacobian for constant turn-rate motion

Syntax

```
jacobian = constturnjac(state)
jacobian = constturnjac(state,dt)
[jacobian,noisejacobian] = constturnjac(state,w,dt)
```

Description

`jacobian = constturnjac(state)` returns the updated Jacobian, `jacobian`, for constant turn-rate Kalman filter motion model for a one-second step time. The `state` argument specifies the current state of the filter. Constant turn rate means that motion in the x-y plane follows a constant angular velocity and motion in the vertical z directions follows a constant velocity model.

`jacobian = constturnjac(state,dt)` specifies the time step, `dt`.

`[jacobian,noisejacobian] = constturnjac(state,w,dt)` also specifies noise, `w`, and returns the Jacobian, `noisejacobian`, of the state with respect to the noise.

Examples

Compute State Jacobian for Constant Turn-Rate Motion

Compute the Jacobian for a constant turn-rate motion state. Assume the turn rate is 12 degrees/second. The time step is one second.

```
state = [500,0,0,100,12];
jacobian = constturnjac(state)
```

`jacobian = 5×5`

```

1.0000    0.9927         0   -0.1043   -0.8631
         0    0.9781         0   -0.2079   -1.7072
         0    0.1043    1.0000    0.9927   -0.1213
         0    0.2079         0    0.9781   -0.3629
         0         0         0         0    1.0000
```

Compute State Jacobian for Constant Turn-Rate Motion with Specified Time Step

Compute the Jacobian for a constant turn-rate motion state. Assume the turn rate is 12 degrees/second. The time step is 0.1 second.

```
state = [500,0,0,100,12];
jacobian = constturnjac(state,0.1)
```



```
jacobian = 5x5
```

```

1.0000    0.1000         0   -0.0010   -0.0087
      0    0.9998         0   -0.0209   -0.1745
      0    0.0010    1.0000    0.1000   -0.0001
      0    0.0209         0    0.9998   -0.0037
      0         0         0         0    1.0000

```

Input Arguments

state — State vector

real-valued 5-element vector | real-valued 7-element vector

State vector for a constant turn-rate motion model in two or three spatial dimensions, specified as a real-valued vector.

- When specified as a 5-element vector, the state vector describes 2-D motion in the x-y plane. You can specify the state vector as a row or column vector. The components of the state vector are `[x; vx; y; vy; omega]` where `x` represents the x-coordinate and `vx` represents the velocity in the x-direction. `y` represents the y-coordinate and `vy` represents the velocity in the y-direction. `omega` represents the turn rate.
- When specified as a 7-element vector, the state vector describes 3-D motion. You can specify the state vector as a row or column vector. The components of the state vector are `[x; vx; y; vy; omega; z; vz]` where `x` represents the x-coordinate and `vx` represents the velocity in the x-direction. `y` represents the y-coordinate and `vy` represents the velocity in the y-direction. `omega` represents the turn rate. `z` represents the z-coordinate and `vz` represents the velocity in the z-direction.

Position coordinates are in meters. Velocity coordinates are in meters/second. Turn rate is in degrees/second.

Example: `[5;0.1;4;-0.2;0.01]`

Data Types: `double`

dt — Time step interval of filter

1.0 (default) | positive scalar

Time step interval of filter, specified as a positive scalar. Time units are in seconds.

Example: `0.5`

Data Types: `single` | `double`

w — State noise

scalar | real-valued $(D+1)$ vector

State noise, specified as a scalar or real-valued M -by- $(D+1)$ -length vector. D is the number of motion dimensions. D is two for 2-D motion and D is three for 3-D motion. The vector components are `[ax; ay; alpha]` for 2-D motion or `[ax; ay; alpha; az]` for 3-D motion. `ax`, `ay`, and `az` are the linear acceleration noise values in the x-, y-, and z-axes, respectively, and `alpha` is the angular acceleration noise value. If specified as a scalar, the value expands to a $(D+1)$ vector.

Data Types: `single` | `double`

Output Arguments

jacobian — Constant turn-rate motion Jacobian

real-valued 5-by-5 matrix | real-valued 7-by-7 matrix

Constant turn-rate motion Jacobian, returned as a real-valued 5-by-5 matrix or 7-by-7 matrix depending on the size of the `state` vector. The Jacobian is constructed from the partial derivatives of the state at the updated time step with respect to the state at the previous time step.

noisejacobian — Constant turn-rate motion noise Jacobian

real-valued 5-by-5 matrix | real-valued 7-by-7 matrix

Constant turn-rate motion noise Jacobian, returned as a real-valued 5-by- $(D+1)$ matrix where D is two for 2-D motion or a real-valued 7-by- $(D+1)$ matrix where D is three for 3-D motion. The Jacobian is constructed from the partial derivatives of the state at the updated time step with respect to the noise components.

Extended Capabilities

C/C++ Code Generation

Generate C and C++ code using MATLAB® Coder™.

See Also

Functions

cameas | cameasjac | constacc | constaccjac | constturn | constvel | constveljac | ctmeas | ctmeasjac | cvmeas | cvmeasjac | initctekf

Objects

trackingEKF

Introduced in R2018b

ctmeas

Measurement function for constant turn-rate motion

Syntax

```
measurement = ctmeas(state)
measurement = ctmeas(state, frame)
measurement = ctmeas(state, frame, sensorpos)
measurement = ctmeas(state, frame, sensorpos, sensorvel)
measurement = ctmeas(state, frame, sensorpos, sensorvel, laxes)
measurement = ctmeas(state, measurementParameters)
```

Description

`measurement = ctmeas(state)` returns the measurement for a constant turn-rate Kalman filter motion model in rectangular coordinates. The `state` argument specifies the current state of the filter.

`measurement = ctmeas(state, frame)` also specifies the measurement coordinate system, `frame`.

`measurement = ctmeas(state, frame, sensorpos)` also specifies the sensor position, `sensorpos`.

`measurement = ctmeas(state, frame, sensorpos, sensorvel)` also specifies the sensor velocity, `sensorvel`.

`measurement = ctmeas(state, frame, sensorpos, sensorvel, laxes)` also specifies the local sensor axes orientation, `laxes`.

`measurement = ctmeas(state, measurementParameters)` specifies the measurement parameters, `measurementParameters`.

Examples

Create Measurement from Constant Turn-Rate Motion in Rectangular Frame

Create a measurement from an object undergoing constant turn-rate motion. The state is the position and velocity in each dimension and the turn-rate. The measurements are in rectangular coordinates.

```
state = [1;10;2;20;5];
measurement = ctmeas(state)
```

```
measurement = 3×1
```

```
1
2
0
```

The z-component of the measurement is zero.

Create Measurement from Constant Turn-Rate Motion in Spherical Frame

Define the state of an object in 2-D constant turn-rate motion. The state is the position and velocity in each dimension, and the turn rate. The measurements are in spherical coordinates.

```
state = [1;10;2;20;5];  
measurement = ctmeas(state, 'spherical')
```

```
measurement = 4×1
```

```
63.4349  
0  
2.2361  
22.3607
```

The elevation of the measurement is zero and the range rate is positive indicating that the object is moving away from the sensor.

Create Measurement from Constant Turn-Rate Motion in Translated Spherical Frame

Define the state of an object moving in 2-D constant turn-rate motion. The state consists of position and velocity, and the turn rate. The measurements are in spherical coordinates with respect to a frame located at [20;40;0].

```
state = [1;10;2;20;5];  
measurement = ctmeas(state, 'spherical', [20;40;0])
```

```
measurement = 4×1
```

```
-116.5651  
0  
42.4853  
-22.3607
```

The elevation of the measurement is zero and the range rate is negative indicating that the object is moving toward the sensor.

Create Measurement from Constant Turn-Rate Motion using Measurement Parameters

Define the state of an object moving in 2-D constant turn-rate motion. The state consists of position and velocity, and the turn rate. The measurements are in spherical coordinates with respect to a frame located at [20;40;0].

```
state2d = [1;10;2;20;5];  
frame = 'spherical';
```

```

sensorpos = [20;40;0];
sensorvel = [0;5;0];
laxes = eye(3);
measurement = ctmeas(state2d,frame,sensorpos,sensorvel,laxes)

```

```

measurement = 4×1

```

```

-116.5651
     0
  42.4853
 -17.8885

```

The elevation of the measurement is zero and the range rate is negative indicating that the object is moving toward the sensor.

Put the measurement parameters in a structure and use the alternative syntax.

```

measparm = struct('Frame',frame,'OriginPosition',sensorpos, ...
    'OriginVelocity',sensorvel,'Orientation',laxes);
measurement = ctmeas(state2d,measparm)

```

```

measurement = 4×1

```

```

-116.5651
     0
  42.4853
 -17.8885

```

Input Arguments

state — State vector

real-valued 5-element vector | real-valued 7-element vector | 5-by- N real-valued matrix | 7-by- N real-valued matrix

State vector for a constant turn-rate motion model in two or three spatial dimensions, specified as a real-valued vector or matrix.

- When specified as a 5-element vector, the state vector describes 2-D motion in the x - y plane. You can specify the state vector as a row or column vector. The components of the state vector are $[x; vx; y; vy; \omega]$ where x represents the x -coordinate and vx represents the velocity in the x -direction. y represents the y -coordinate and vy represents the velocity in the y -direction. ω represents the turn rate.

When specified as a 5-by- N matrix, each column represents a different state vector N represents the number of states.

- When specified as a 7-element vector, the state vector describes 3-D motion. You can specify the state vector as a row or column vector. The components of the state vector are $[x; vx; y; vy; \omega; z; vz]$ where x represents the x -coordinate and vx represents the velocity in the x -direction. y represents the y -coordinate and vy represents the velocity in the y -direction. ω represents the turn rate. z represents the z -coordinate and vz represents the velocity in the z -direction.

When specified as a 7-by- N matrix, each column represents a different state vector. N represents the number of states.

Position coordinates are in meters. Velocity coordinates are in meters/second. Turn rate is in degrees/second.

Example: [5;0.1;4;-0.2;0.01]

Data Types: double

frame — Measurement output frame

'rectangular' (default) | 'spherical'

Measurement output frame, specified as 'rectangular' or 'spherical'. When the frame is 'rectangular', a measurement consists of x , y , and z Cartesian coordinates. When specified as 'spherical', a measurement consists of azimuth, elevation, range, and range rate.

Data Types: char

sensorpos — Sensor position

[0;0;0] (default) | real-valued 3-by-1 column vector

Sensor position with respect to the navigation frame, specified as a real-valued 3-by-1 column vector. Units are in meters.

Data Types: double

sensorvel — Sensor velocity

[0;0;0] (default) | real-valued 3-by-1 column vector

Sensor velocity with respect to the navigation frame, specified as a real-valued 3-by-1 column vector. Units are in m/s.

Data Types: double

laxes — Local sensor coordinate axes

[1,0,0;0,1,0;0,0,1] (default) | 3-by-3 orthogonal matrix

Local sensor coordinate axes, specified as a 3-by-3 orthogonal matrix. Each column specifies the direction of the local x -, y -, and z -axes, respectively, with respect to the navigation frame. That is, the matrix is the rotation matrix from the global frame to the sensor frame.

Data Types: double

measurementParameters — Measurement parameters

structure | array of structure

Measurement parameters, specified as a structure or an array of structures. The fields of the structure are:

Field	Description	Example
Frame	<p>Frame used to report measurements, specified as one of these values:</p> <ul style="list-style-type: none"> 'rectangular' — Detections are reported in rectangular coordinates. 'spherical' — Detections are reported in spherical coordinates. 	'spherical'
OriginPosition	Position offset of the origin of the frame relative to the parent frame, specified as an [x y z] real-valued vector.	[0 0 0]
OriginVelocity	Velocity offset of the origin of the frame relative to the parent frame, specified as a [vx vy vz] real-valued vector.	[0 0 0]
Orientation	Frame rotation matrix, specified as a 3-by-3 real-valued orthonormal matrix.	[1 0 0; 0 1 0; 0 0 1]
HasAzimuth	Logical scalar indicating if azimuth is included in the measurement.	1
HasElevation	Logical scalar indicating if elevation is included in the measurement. For measurements reported in a rectangular frame, and if HasElevation is false, the reported measurements assume 0 degrees of elevation.	1
HasRange	Logical scalar indicating if range is included in the measurement.	1
HasVelocity	Logical scalar indicating if the reported detections include velocity measurements. For measurements reported in the rectangular frame, if HasVelocity is false, the measurements are reported as [x y z]. If HasVelocity is true, measurements are reported as [x y z vx vy vz].	1

Field	Description	Example
IsParentToChild	Logical scalar indicating if <code>Orientation</code> performs a frame rotation from the parent coordinate frame to the child coordinate frame. When <code>IsParentToChild</code> is false, then <code>Orientation</code> performs a frame rotation from the child coordinate frame to the parent coordinate frame.	0

If you only want to perform one coordinate transformation, such as a transformation from the body frame to the sensor frame, you only need to specify a measurement parameter structure. If you want to perform multiple coordinate transformations, you need to specify an array of measurement parameter structures. To learn how to perform multiple transformations, see the “Convert Detections to objectDetection Format” example.

Data Types: struct

Output Arguments

measurement — Measurement vector

N-by-1 column vector

Measurement vector, returned as an *N*-by-1 column vector. The form of the measurement depends upon which syntax you use.

- When the syntax does not use the `measurementParameters` argument, the measurement vector is $[x, y, z]$ when the `frame` input argument is set to 'rectangular' and $[az; el; r; rr]$ when the `frame` is set to 'spherical'.
- When the syntax uses the `measurementParameters` argument, the size of the measurement vector depends on the values of the `frame`, `HasVelocity`, and `HasElevation` fields in the `measurementParameters` structure.

frame	measurement															
'spherical'	<p>Specifies the azimuth angle, <i>az</i>, elevation angle, <i>el</i>, range, <i>r</i>, and range rate, <i>rr</i>, of the object with respect to the local ego vehicle coordinate system. Positive values for range rate indicate that an object is moving away from the sensor.</p> <p>Spherical measurements</p> <table border="1"> <thead> <tr> <th></th> <th></th> <th colspan="2">HasElevation</th> </tr> </thead> <tbody> <tr> <td></td> <td></td> <td>false</td> <td>true</td> </tr> <tr> <td rowspan="2">HasVelocity</td> <td>false</td> <td>[az;r]</td> <td>[az;el;r]</td> </tr> <tr> <td>true</td> <td>[az;r;rr]</td> <td>[az;el;r;rr]</td> </tr> </tbody> </table> <p>Angle units are in degrees, range units are in meters, and range rate units are in m/s.</p>			HasElevation				false	true	HasVelocity	false	[az;r]	[az;el;r]	true	[az;r;rr]	[az;el;r;rr]
		HasElevation														
		false	true													
HasVelocity	false	[az;r]	[az;el;r]													
	true	[az;r;rr]	[az;el;r;rr]													
'rectangular'	<p>Specifies the Cartesian position and velocity coordinates of the tracked object with respect to the ego vehicle coordinate system.</p> <p>Rectangular measurements</p> <table border="1"> <thead> <tr> <th>HasVelocity</th> <th></th> <th></th> </tr> </thead> <tbody> <tr> <td>false</td> <td></td> <td>[x;y;y]</td> </tr> <tr> <td>true</td> <td></td> <td>[x;y;z;vx;vy;vz]</td> </tr> </tbody> </table> <p>Position units are in meters and velocity units are in m/s.</p>	HasVelocity			false		[x;y;y]	true		[x;y;z;vx;vy;vz]						
HasVelocity																
false		[x;y;y]														
true		[x;y;z;vx;vy;vz]														

Data Types: double

More About

Azimuth and Elevation Angle Definitions

Define the azimuth and elevation angles used in the toolbox.

The azimuth angle of a vector is the angle between the x-axis and its orthogonal projection onto the xy plane. The angle is positive in going from the x axis toward the y axis. Azimuth angles lie between -180 and 180 degrees. The elevation angle is the angle between the vector and its orthogonal projection onto the xy-plane. The angle is positive when going toward the positive z-axis from the xy plane.

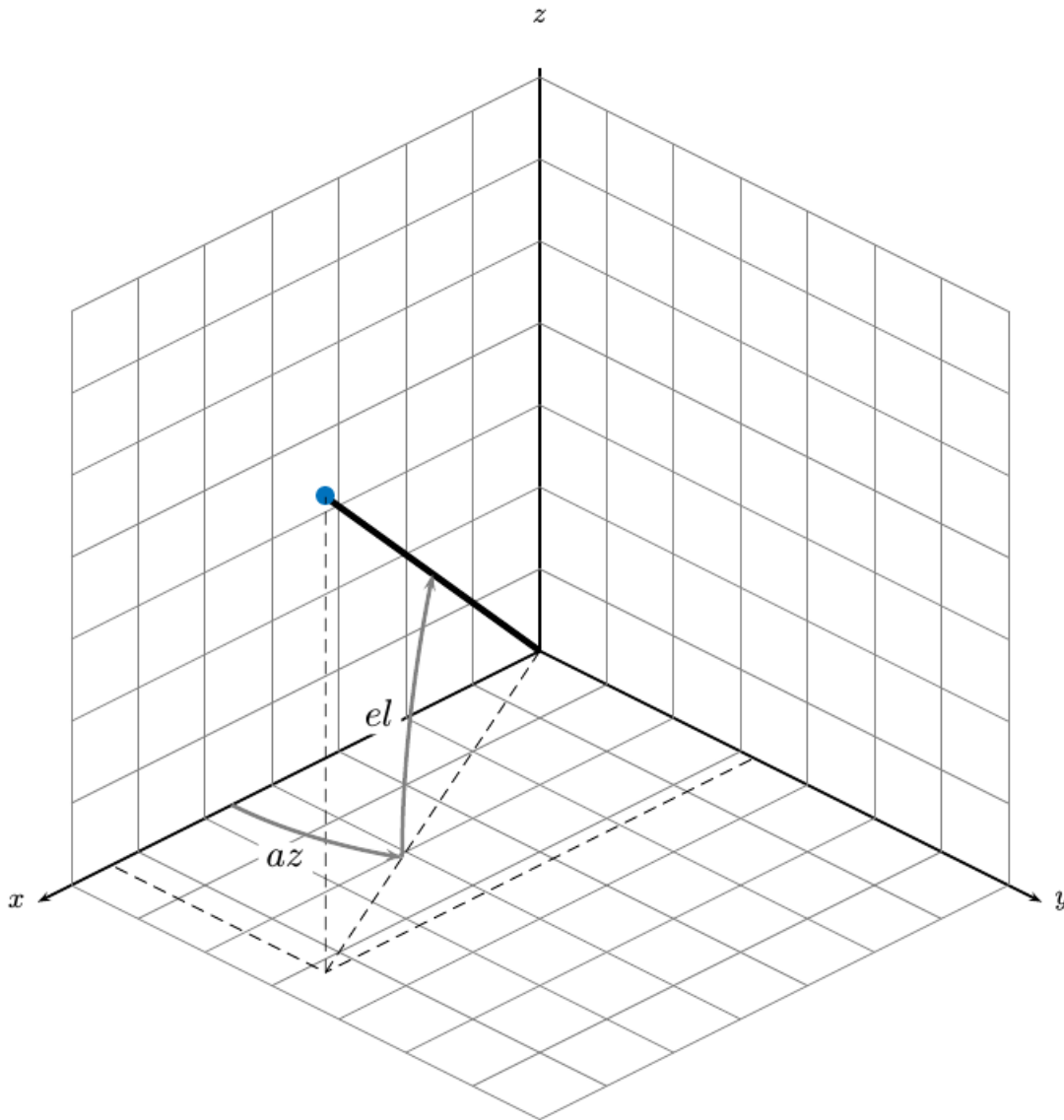

Extended Capabilities

C/C++ Code Generation

Generate C and C++ code using MATLAB® Coder™.

See Also

Functions

cameas | cameasjac | constacc | constaccjac | constturn | constturnjac | constvel | constveljac | ctmeasjac | cvmeas | cvmeasjac

Objects

trackingCKF | trackingEKF | trackingKF | trackingMSCEKF | trackingPF | trackingUKF

Introduced in R2018b

ctmeasjac

Jacobian of measurement function for constant turn-rate motion

Syntax

```
measurementjac = ctmeasjac(state)
measurementjac = ctmeasjac(state, frame)
measurementjac = ctmeasjac(state, frame, sensorpos)
measurementjac = ctmeasjac(state, frame, sensorpos, sensorvel)
measurementjac = ctmeasjac(state, frame, sensorpos, sensorvel, laxes)
measurementjac = ctmeasjac(state, measurementParameters)
```

Description

`measurementjac = ctmeasjac(state)` returns the measurement Jacobian, `measurementjac`, for a constant turn-rate Kalman filter motion model in rectangular coordinates. `state` specifies the current state of the track.

`measurementjac = ctmeasjac(state, frame)` also specifies the measurement coordinate system, `frame`.

`measurementjac = ctmeasjac(state, frame, sensorpos)` also specifies the sensor position, `sensorpos`.

`measurementjac = ctmeasjac(state, frame, sensorpos, sensorvel)` also specifies the sensor velocity, `sensorvel`.

`measurementjac = ctmeasjac(state, frame, sensorpos, sensorvel, laxes)` also specifies the local sensor axes orientation, `laxes`.

`measurementjac = ctmeasjac(state, measurementParameters)` specifies the measurement parameters, `measurementParameters`.

Examples

Measurement Jacobian of Constant Turn-Rate Motion in Rectangular Frame

Define the state of an object in 2-D constant turn-rate motion. The state is the position and velocity in each dimension, and the turn rate. Construct the measurement Jacobian in rectangular coordinates.

```
state = [1;10;2;20;5];
jacobian = ctmeasjac(state)
```

```
jacobian = 3×5
```

```
    1    0    0    0    0
    0    0    1    0    0
    0    0    0    0    0
```

Measurement Jacobian of Constant Turn-Rate Motion in Spherical Frame

Define the state of an object in 2-D constant turn-rate motion. The state is the position and velocity in each dimension, and the turn rate. Compute the measurement Jacobian with respect to spherical coordinates.

```
state = [1;10;2;20;5];
measurementjac = ctmeasjac(state, 'spherical')

measurementjac = 4x5

   -22.9183         0    11.4592         0         0
         0         0         0         0         0
    0.4472         0    0.8944         0         0
    0.0000    0.4472    0.0000    0.8944         0
```

Measurement Jacobian of Constant Turn-Rate Object in Translated Spherical Frame

Define the state of an object in 2-D constant turn-rate motion. The state is the position and velocity in each dimension, and the turn rate. Compute the measurement Jacobian with respect to spherical coordinates centered at [5; -20; 0].

```
state = [1;10;2;20;5];
sensorpos = [5;-20;0];
measurementjac = ctmeasjac(state, 'spherical', sensorpos)

measurementjac = 4x5

   -2.5210         0   -0.4584         0         0
         0         0         0         0         0
   -0.1789         0    0.9839         0         0
    0.5903   -0.1789    0.1073    0.9839         0
```

Measurement Jacobian of Constant Turn-Rate Object Using Measurement Parameters

Define the state of an object in 2-D constant turn-rate motion. The state is the position and velocity in each dimension, and the turn rate. Compute the measurement Jacobian with respect to spherical coordinates centered at [25; -40; 0].

```
state2d = [1;10;2;20;5];
sensorpos = [25,-40,0].';
frame = 'spherical';
sensorvel = [0;5;0];
laxes = eye(3);
measurementjac = ctmeasjac(state2d, frame, sensorpos, sensorvel, laxes)

measurementjac = 4x5
```

```

-1.0284      0    -0.5876      0      0
      0      0      0      0      0
-0.4961      0      0.8682      0      0
 0.2894  -0.4961    0.1654    0.8682    0

```

Put the measurement parameters in a structure and use the alternative syntax.

```

measparm = struct('Frame',frame,'OriginPosition',sensorpos,'OriginVelocity',sensorvel, ...
    'Orientation',laxes);
measurementjac = ctmeasjac(state2d,measparm)

```

```

measurementjac = 4x5

```

```

-1.0284      0    -0.5876      0      0
      0      0      0      0      0
-0.4961      0      0.8682      0      0
 0.2894  -0.4961    0.1654    0.8682    0

```

Input Arguments

state — State vector

real-valued 5-element vector | real-valued 7-element vector | 5-by- N real-valued matrix | 7-by- N real-valued matrix

State vector for a constant turn-rate motion model in two or three spatial dimensions, specified as a real-valued vector or matrix.

- When specified as a 5-element vector, the state vector describes 2-D motion in the x - y plane. You can specify the state vector as a row or column vector. The components of the state vector are $[x; vx; y; vy; \omega]$ where x represents the x -coordinate and vx represents the velocity in the x -direction. y represents the y -coordinate and vy represents the velocity in the y -direction. ω represents the turn rate.

When specified as a 5-by- N matrix, each column represents a different state vector N represents the number of states.

- When specified as a 7-element vector, the state vector describes 3-D motion. You can specify the state vector as a row or column vector. The components of the state vector are $[x; vx; y; vy; \omega; z; vz]$ where x represents the x -coordinate and vx represents the velocity in the x -direction. y represents the y -coordinate and vy represents the velocity in the y -direction. ω represents the turn rate. z represents the z -coordinate and vz represents the velocity in the z -direction.

When specified as a 7-by- N matrix, each column represents a different state vector. N represents the number of states.

Position coordinates are in meters. Velocity coordinates are in meters/second. Turn rate is in degrees/second.

Example: `[5;0.1;4;-0.2;0.01]`

Data Types: `double`

frame — Measurement output frame

'rectangular' (default) | 'spherical'

Measurement output frame, specified as 'rectangular' or 'spherical'. When the frame is 'rectangular', a measurement consists of x , y , and z Cartesian coordinates. When specified as 'spherical', a measurement consists of azimuth, elevation, range, and range rate.

Data Types: char

sensorpos — Sensor position

[0;0;0] (default) | real-valued 3-by-1 column vector

Sensor position with respect to the navigation frame, specified as a real-valued 3-by-1 column vector. Units are in meters.

Data Types: double

sensorvel — Sensor velocity

[0;0;0] (default) | real-valued 3-by-1 column vector

Sensor velocity with respect to the navigation frame, specified as a real-valued 3-by-1 column vector. Units are in m/s.

Data Types: double

laxes — Local sensor coordinate axes

[1,0,0;0,1,0;0,0,1] (default) | 3-by-3 orthogonal matrix

Local sensor coordinate axes, specified as a 3-by-3 orthogonal matrix. Each column specifies the direction of the local x -, y -, and z -axes, respectively, with respect to the navigation frame. That is, the matrix is the rotation matrix from the global frame to the sensor frame.

Data Types: double

measurementParameters — Measurement parameters

structure | array of structure

Measurement parameters, specified as a structure or an array of structures. The fields of the structure are:

Field	Description	Example
Frame	Frame used to report measurements, specified as one of these values: <ul style="list-style-type: none"> 'rectangular' — Detections are reported in rectangular coordinates. 'spherical' — Detections are reported in spherical coordinates. 	'spherical'

Field	Description	Example
OriginPosition	Position offset of the origin of the frame relative to the parent frame, specified as an [x y z] real-valued vector.	[0 0 0]
OriginVelocity	Velocity offset of the origin of the frame relative to the parent frame, specified as a [vx vy vz] real-valued vector.	[0 0 0]
Orientation	Frame rotation matrix, specified as a 3-by-3 real-valued orthonormal matrix.	[1 0 0; 0 1 0; 0 0 1]
HasAzimuth	Logical scalar indicating if azimuth is included in the measurement.	1
HasElevation	Logical scalar indicating if elevation is included in the measurement. For measurements reported in a rectangular frame, and if HasElevation is false, the reported measurements assume 0 degrees of elevation.	1
HasRange	Logical scalar indicating if range is included in the measurement.	1
HasVelocity	Logical scalar indicating if the reported detections include velocity measurements. For measurements reported in the rectangular frame, if HasVelocity is false, the measurements are reported as [x y z]. If HasVelocity is true, measurements are reported as [x y z vx vy vz].	1
IsParentToChild	Logical scalar indicating if Orientation performs a frame rotation from the parent coordinate frame to the child coordinate frame. When IsParentToChild is false, then Orientation performs a frame rotation from the child coordinate frame to the parent coordinate frame.	0

If you only want to perform one coordinate transformation, such as a transformation from the body frame to the sensor frame, you only need to specify a measurement parameter structure. If you want to perform multiple coordinate transformations, you need to specify an array of measurement parameter structures. To learn how to perform multiple transformations, see the “Convert Detections to objectDetection Format” example.

Data Types: `struct`

Output Arguments

measurementjac — Measurement Jacobian

real-valued 3-by-5 matrix | real-valued 4-by-5 matrix

Measurement Jacobian, returned as a real-valued 3-by-5 or 4-by-5 matrix. The row dimension and interpretation depend on value of the `frame` argument.

Frame	Measurement Jacobian
'rectangular'	Jacobian of the measurements $[x; y; z]$ with respect to the state vector. The measurement vector is with respect to the local coordinate system. Coordinates are in meters.
'spherical'	Jacobian of the measurement vector $[az; el; r; rr]$ with respect to the state vector. Measurement vector components specify the azimuth angle, elevation angle, range, and range rate of the object with respect to the local sensor coordinate system. Angle units are in degrees. Range units are in meters and range rate units are in meters/second.

More About

Azimuth and Elevation Angle Definitions

Define the azimuth and elevation angles used in the toolbox.

The azimuth angle of a vector is the angle between the x -axis and its orthogonal projection onto the xy plane. The angle is positive in going from the x axis toward the y axis. Azimuth angles lie between -180 and 180 degrees. The elevation angle is the angle between the vector and its orthogonal projection onto the xy -plane. The angle is positive when going toward the positive z -axis from the xy plane.

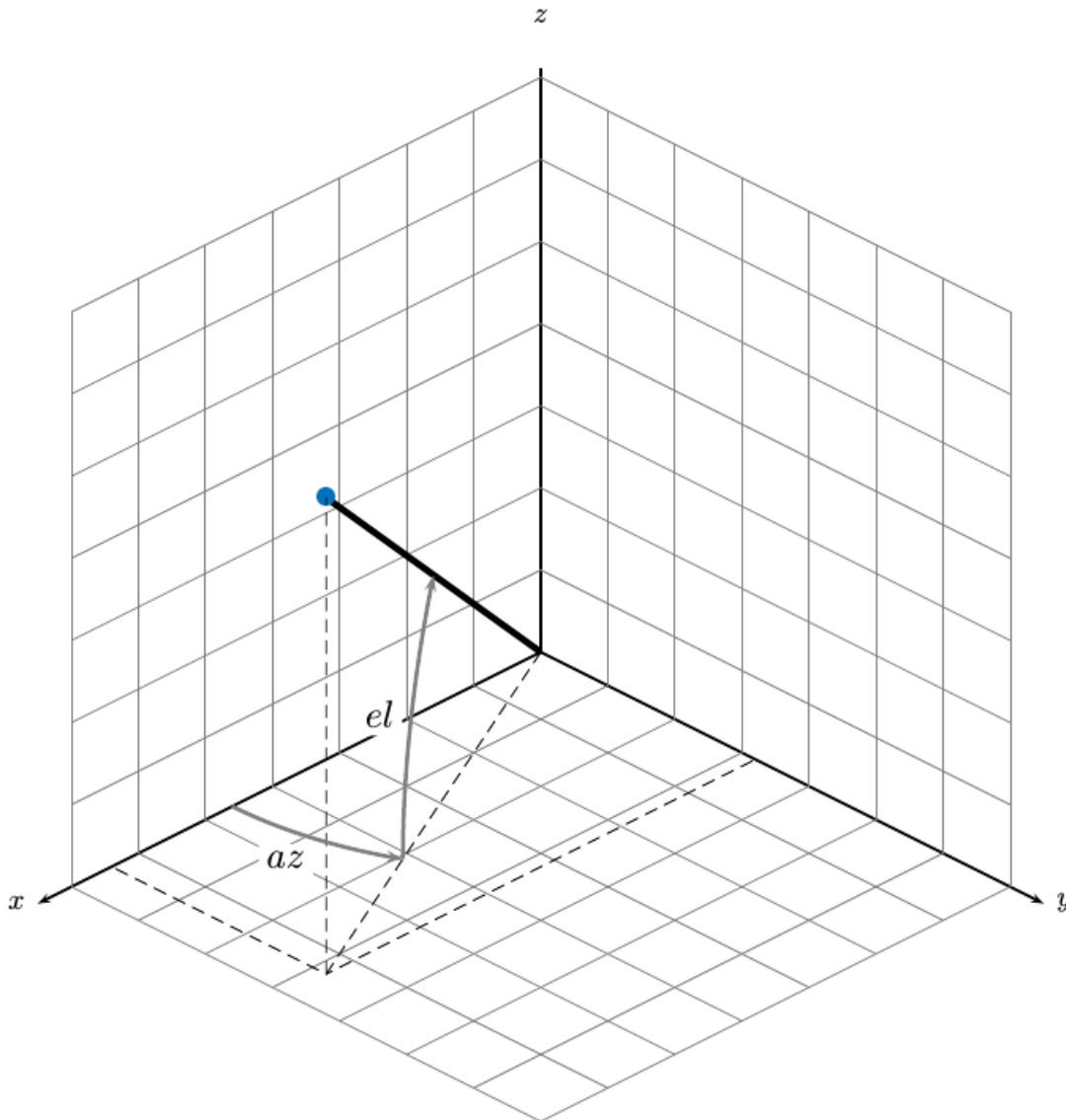

Extended Capabilities

C/C++ Code Generation

Generate C and C++ code using MATLAB® Coder™.

See Also

Functions

cameas | cameasjac | constacc | constaccjac | constturn | constturnjac | constvel | constveljac | ctmeas | cvmeas | cvmeasjac

Objects

trackingCKF | trackingEKF | trackingKF | trackingMSCEKF | trackingPF | trackingUKF

Introduced in R2018b

getTrackPositions

Returns updated track positions and position covariance matrix

Syntax

```
position = getTrackPositions(tracks,positionSelector)
[position,positionCovariances] = getTrackPositions(tracks,positionSelector)
```

Description

`position = getTrackPositions(tracks,positionSelector)` returns a matrix of track positions. Each row contains the position of a tracked object.

`[position,positionCovariances] = getTrackPositions(tracks,positionSelector)` returns a matrix of track positions.

Examples

Find Position of 3-D Constant-Acceleration Object

Create an extended Kalman filter tracker for 3-D constant-acceleration motion.

```
tracker = trackerTOMHT('FilterInitializationFcn',@initcaekf);
```

Update the tracker with a single detection and get the tracks output.

```
detection = objectDetection(0,[10;-20;4], 'ObjectClassID',3);
tracks = tracker(detection,0)
```

```
tracks =
  objectTrack with properties:
    TrackID: 1
    BranchID: 1
    SourceIndex: 0
    UpdateTime: 0
    Age: 1
    State: [9x1 double]
    StateCovariance: [9x9 double]
    StateParameters: [1x1 struct]
    ObjectClassID: 3
    TrackLogic: 'Score'
    TrackLogicState: [13.7102 13.7102]
    IsConfirmed: 1
    IsCoasted: 0
    IsSelfReported: 1
    ObjectAttributes: [1x1 struct]
```

Obtain the position vector from the track state.

```
positionSelector = [1 0 0 0 0 0 0 0; 0 0 0 1 0 0 0 0; 0 0 0 0 0 0 1 0];
position = getTrackPositions(tracks, positionSelector)
```

```
position = 1×3
```

```
    10.0000    -20.0000     4.0000
```

Find Position and Covariance of 3-D Constant-Velocity Object

Create an extended Kalman filter tracker for 3-D constant-velocity motion.

```
tracker = trackerTOMHT('FilterInitializationFcn',@initcvekf);
```

Update the tracker with a single detection and get the tracks output.

```
detection = objectDetection(0,[10;3;-7], 'ObjectClassID',3);
tracks = tracker(detection,0)
```

```
tracks =
```

```
    objectTrack with properties:
```

```
        TrackID: 1
        BranchID: 1
        SourceIndex: 0
        UpdateTime: 0
        Age: 1
        State: [6x1 double]
        StateCovariance: [6x6 double]
        StateParameters: [1x1 struct]
        ObjectClassID: 3
        TrackLogic: 'Score'
        TrackLogicState: [13.7102 13.7102]
        IsConfirmed: 1
        IsCoasted: 0
        IsSelfReported: 1
        ObjectAttributes: [1x1 struct]
```

Obtain the position vector and position covariance for that track

```
positionSelector = [1 0 0 0 0 0; 0 0 1 0 0 0; 0 0 0 0 1 0];
[position,positionCovariance] = getTrackPositions(tracks,positionSelector)
```

```
position = 1×3
```

```
    10.0000     3.0000    -7.0000
```

```
positionCovariance = 3×3
```

```
    1.0000    -0.0000     0
   -0.0000     1.0000    -0.0000
     0     -0.0000     1.0000
```

Input Arguments

tracks — Object tracks

array of `objectTrack` objects | array of structures

Object tracks, specified as an array of `objectTrack` objects or an array of structures containing sufficient information to obtain the track position information. At a minimum, these structures must contain a `State` column vector field and a positive-definite `StateCovariance` matrix field. For a sample track structure, see `toStruct`.

positionSelector — Position selection matrix

D -by- N real-valued matrix.

Position selector, specified as a D -by- N real-valued matrix of ones and zeros. D is the number of dimensions of the tracker. N is the size of the state vector. Using this matrix, the function extracts track positions from the state vector. Multiply the state vector by position selector matrix returns positions. The same selector is applied to all object tracks.

Output Arguments

position — Positions of tracked objects

real-valued M -by- D matrix

Positions of tracked objects at last update time, returned as a real-valued M -by- D matrix. D represents the number of position elements. M represents the number of tracks.

positionCovariances — Position covariance matrices of tracked objects

real-valued D -by- D - M array

Position covariance matrices of tracked objects, returned as a real-valued D -by- D - M array. D represents the number of position elements. M represents the number of tracks. Each D -by- D submatrix is a position covariance matrix for a track.

More About

Position Selector for 2-Dimensional Motion

Show the position selection matrix for two-dimensional motion when the state consists of the position and velocity.

$$\begin{bmatrix} 1 & 0 & 0 & 0 \\ 0 & 0 & 1 & 0 \end{bmatrix}$$

Position Selector for 3-Dimensional Motion

Show the position selection matrix for three-dimensional motion when the state consists of the position and velocity.

$$\begin{bmatrix} 1 & 0 & 0 & 0 & 0 & 0 \\ 0 & 0 & 1 & 0 & 0 & 0 \\ 0 & 0 & 0 & 0 & 1 & 0 \end{bmatrix}$$

Position Selector for 3-Dimensional Motion with Acceleration

Show the position selection matrix for three-dimensional motion when the state consists of the position, velocity, and acceleration.

$$\begin{bmatrix} 1 & 0 & 0 & 0 & 0 & 0 & 0 & 0 & 0 \\ 0 & 0 & 0 & 1 & 0 & 0 & 0 & 0 & 0 \\ 0 & 0 & 0 & 0 & 0 & 0 & 1 & 0 & 0 \end{bmatrix}$$

Extended Capabilities

C/C++ Code Generation

Generate C and C++ code using MATLAB® Coder™.

See Also

Functions

[getTrackVelocities](#) | [initcaekf](#) | [initcakf](#) | [initcaukf](#) | [initctekf](#) | [initctukf](#) | [initcvkf](#) | [initcvukf](#)

Objects

[objectDetection](#) | [trackerGNN](#) | [trackerTOMHT](#)

Introduced in R2018b

getTrackVelocities

Obtain updated track velocities and velocity covariance matrix

Syntax

```
velocity = getTrackVelocities(tracks,velocitySelector)
[velocity,velocityCovariances] = getTrackVelocities(tracks,velocitySelector)
```

Description

`velocity = getTrackVelocities(tracks,velocitySelector)` returns velocities of tracked objects.

`[velocity,velocityCovariances] = getTrackVelocities(tracks,velocitySelector)` also returns the track velocity covariance matrices.

Examples

Find Velocity of 3-D Constant-Acceleration Object

Create an extended Kalman filter tracker for 3-D constant-acceleration motion.

```
tracker = trackerGNN('FilterInitializationFcn',@initcaekf);
```

Initialize the tracker with one detection.

```
detection = objectDetection(0,[10;-20;4],'ObjectClassID',3);
tracks = tracker(detection,0);
```

Add a second detection at a later time and at a different position.

```
detection = objectDetection(0.1,[10.3;-20.2;4],'ObjectClassID',3);
tracks = tracker(detection,0.2);
```

Obtain the velocity vector from the track state.

```
velocitySelector = [0 1 0 0 0 0 0 0 0; 0 0 0 0 1 0 0 0 0; 0 0 0 0 0 0 0 0 1 0];
velocity = getTrackVelocities(tracks,velocitySelector)
```

```
velocity = 1×3
```

```
    1.0093    -0.6728         0
```

Velocity and Covariance of 3-D Constant-Acceleration Object

Create an extended Kalman filter tracker for 3-D constant-acceleration motion.

```
tracker = trackerGNN('FilterInitializationFcn',@initcaekf);
```

Initialize the tracker with one detection.

```
detection = objectDetection(0,[10;-20;4], 'ObjectClassID',3);
tracks = tracker(detection,0);
```

Add a second detection at a later time and at a different position.

```
detection = objectDetection(0.1,[10.3;-20.2;4.3], 'ObjectClassID',3);
tracks = tracker(detection,0.2);
```

Obtain the velocity vector from the track state.

```
velocitySelector = [0 1 0 0 0 0 0 0 0; 0 0 0 0 1 0 0 0 0; 0 0 0 0 0 0 0 0 1 0];
[velocity,velocityCovariance] = getTrackVelocities(tracks,velocitySelector)
```

velocity = 1×3

```
    1.0093    -0.6728     1.0093
```

velocityCovariance = 3×3

```
    70.0685         0         0
         0    70.0685         0
         0         0    70.0685
```

Input Arguments

tracks — Object tracks

array of `objectTrack` objects | array of structures

Object tracks, specified as an array of `objectTrack` objects or an array of structures containing sufficient information to obtain the track velocity information. At a minimum, these structures must contain a `State` column vector field and a positive-definite `StateCovariance` matrix field. For a sample track structure, see `toStruct`.

velocitySelector — Velocity selection matrix

D -by- N real-valued matrix.

Velocity selector, specified as a D -by- N real-valued matrix of ones and zeros. D is the number of dimensions of the tracker. N is the size of the state vector. Using this matrix, the function extracts track velocities from the state vector. Multiply the state vector by velocity selector matrix returns velocities. The same selector is applied to all object tracks.

Output Arguments

velocity — Velocities of tracked objects

real-valued 1 -by- D vector | real-valued M -by- D matrix

Velocities of tracked objects at last update time, returned as a 1 -by- D vector or a real-valued M -by- D matrix. D represents the number of velocity elements. M represents the number of tracks.

velocityCovariances — Velocity covariance matrices of tracked objects

real-valued D -by- D -matrix | real-valued D -by- D -by- M array

Velocity covariance matrices of tracked objects, returned as a real-valued D -by- D -matrix or a real-valued D -by- D -by- M array. D represents the number of velocity elements. M represents the number of tracks. Each D -by- D submatrix is a velocity covariance matrix for a track.

More About

Velocity Selector for 2-Dimensional Motion

Show the velocity selection matrix for two-dimensional motion when the state consists of the position and velocity.

$$\begin{bmatrix} 0 & 1 & 0 & 0 \\ 0 & 0 & 0 & 1 \end{bmatrix}$$

Velocity Selector for 3-Dimensional Motion

Show the velocity selection matrix for three-dimensional motion when the state consists of the position and velocity.

$$\begin{bmatrix} 0 & 1 & 0 & 0 & 0 & 0 \\ 0 & 0 & 0 & 1 & 0 & 0 \\ 0 & 0 & 0 & 0 & 0 & 1 \end{bmatrix}$$

Velocity Selector for 3-Dimensional Motion with Acceleration

Show the velocity selection matrix for three-dimensional motion when the state consists of the position, velocity, and acceleration.

$$\begin{bmatrix} 0 & 1 & 0 & 0 & 0 & 0 & 0 & 0 \\ 0 & 0 & 0 & 0 & 1 & 0 & 0 & 0 \\ 0 & 0 & 0 & 0 & 0 & 0 & 0 & 1 \end{bmatrix}$$

Extended Capabilities

C/C++ Code Generation

Generate C and C++ code using MATLAB® Coder™.

See Also

Functions

`getTrackPositions` | `initcaekf` | `initcakf` | `initcaukf` | `initctekf` | `initctukf` | `initcvkf` | `initcvukf`

Objects

`objectDetection` | `trackerGNN` | `trackerTOMHT`

Introduced in R2018b

initcaabf

Create constant acceleration alpha-beta tracking filter from detection report

Syntax

```
abf = initcaabf(detection)
```

Description

`abf = initcaabf(detection)` initializes a constant acceleration alpha-beta tracking filter for object tracking based on information provided in `detection`.

The function initializes a constant acceleration state with the same convention as `constacc` and `cameas`, $[x; v_x; a_x; y; v_y; a_y; z; v_z; a_z]$.

Examples

Creating Constant Acceleration trackingABF Object from Detection

Create an `objectDetection` with a position measurement at $x=1$, $y=3$ and a measurement noise of $[1 \ 0.2; 0.2 \ 2]$;

```
detection = objectDetection(0, [1;3], 'MeasurementNoise', [1 0.2;0.2 2]);
```

Use `initccabf` to create a `trackingABF` filter initialized at the provided position and using the measurement noise defined above.

```
ABF = initcaabf(detection);
```

Check the values of the state and measurement noise. Verify that the filter state, `ABF.State`, has the same position components as the `Detection.Measurement`. Verify that the filter measurement noise, `ABF.MeasurementNoise`, is the same as the `Detection.MeasurementNoise` values.

`ABF.State`

```
ans = 6×1
```

```
1
0
0
3
0
0
```

`ABF.MeasurementNoise`

```
ans = 2×2
```

```
1.0000    0.2000
0.2000    2.0000
```

Input Arguments

detection — Detection report

`objectDetection` object

Detection report, specified as an `objectDetection` object.

Example: `detection = objectDetection(0,[1;4.5;3],'MeasurementNoise', [1.0 0 0; 0 2.0 0; 0 0 1.5])`

Output Arguments

abf — Constant velocity alpha-beta filter

`trackingABF` object

Constant acceleration alpha-beta tracking filter for object tracking, returned as a `trackingABF` object.

Algorithms

- The function computes the process noise matrix assuming a unit standard deviation for the acceleration change rate.
- You can use this function as the `FilterInitializationFcn` property of trackers.

Extended Capabilities

C/C++ Code Generation

Generate C and C++ code using MATLAB® Coder™.

See Also

`objectDetection` | `trackingABF` | `trackingEKF` | `trackingKF` | `trackingUKF`

Introduced in R2018b

initcvabf

Create constant velocity tracking alpha-beta filter from detection report

Syntax

```
abf = initcvabf(detection)
```

Description

`abf = initcvabf(detection)` initializes a constant velocity alpha-beta filter for object tracking based on information provided in `detection`.

The function initializes a constant velocity state with the same convention as `constvel` and `cvmeas`, $[x; v_x; y; v_y; z; v_z]$.

Examples

Creating trackingABF Object from Detection

Create an `objectDetection` with a position measurement at $x=1$, $y=3$ and a measurement noise of $[1 \ 0.2; 0.2 \ 2]$;

```
detection = objectDetection(0, [1;3], 'MeasurementNoise', [1 0.2;0.2 2]);
```

Use `initcvabf` to create a `trackingABF` filter initialized at the provided position and using the measurement noise defined above.

```
ABF = initcvabf(detection);
```

Check the values of the state and measurement noise. Verify that the filter state, `ABF.State`, has the same position components as the `Detection.Measurement`. Verify that the filter measurement noise, `ABF.MeasurementNoise`, is the same as the `Detection.MeasurementNoise` values.

`ABF.State`

```
ans = 4×1
```

```
1
0
3
0
```

`ABF.MeasurementNoise`

```
ans = 2×2
```

```
1.0000    0.2000
0.2000    2.0000
```

Input Arguments

detection — Detection report

`objectDetection` object

Detection report, specified as an `objectDetection` object.

Example: `detection = objectDetection(0,[1;4.5;3],'MeasurementNoise', [1.0 0 0; 0 2.0 0; 0 0 1.5])`

Output Arguments

abf — Constant velocity alpha-beta filter

`trackingABF` object

Constant velocity alpha-beta tracking filter for object tracking, returned as a `trackingABF` object.

Algorithms

- The function computes the process noise matrix assuming a unit acceleration standard deviation.
- You can use this function as the `FilterInitializationFcn` property of trackers.

Extended Capabilities

C/C++ Code Generation

Generate C and C++ code using MATLAB® Coder™.

See Also

`objectDetection` | `trackingABF` | `trackingEKF` | `trackingKF` | `trackingUKF`

Introduced in R2018b

initcackf

Create constant acceleration tracking cubature Kalman filter from detection report

Syntax

```
ckf = initcackf(detection)
```

Description

`ckf = initcackf(detection)` initializes a constant acceleration cubature Kalman filter for object tracking based on information provided in an `objectDetection` object, `detection`.

The function initializes a constant acceleration state with the same convention as `constacc` and `cameas`, $[x; v_x; a_x; y; v_y; a_y; z; v_z; a_z]$.

Examples

Create Constant Acceleration Tracking CKF Object from Rectangular Measurements

Create a constant acceleration tracking cubature Kalman filter object, `trackingCKF`, from an initial detection report. The detection report is made from an initial 3-D position measurement of the Kalman filter state in rectangular coordinates. You can obtain the 3-D position measurement using the constant acceleration measurement function, `cameas`.

This example uses the coordinates, $x = 1$, $y = 3$, $z = 0$ and a 3-D position measurement noise of $[1 \ 0.2 \ 0; \ 0.2 \ 2 \ 0; \ 0 \ 0 \ 1]$.

```
detection = objectDetection(0, [1;3;0], 'MeasurementNoise', [1 0.2 0; 0.2 2 0; 0 0 1]);
```

Use `initcackf` to create a `trackingCKF` filter initialized at the provided position and using the measurement noise defined above.

```
ckf = initcackf(detection)
```

```
ckf =
  trackingCKF with properties:
        State: [9x1 double]
    StateCovariance: [9x9 double]
    StateTransitionFcn: @constacc
        ProcessNoise: [3x3 double]
    HasAdditiveProcessNoise: 0
        MeasurementFcn: @cameas
    MeasurementNoise: [3x3 double]
    HasAdditiveMeasurementNoise: 1
        EnableSmoothing: 0
```

Check the values of the state and the measurement noise. Verify that the filter state, `ckf.State`, has the same position components as the detection measurement, `detection.Measurement`.

```
ckf.State
```

```
ans = 9×1
```

```
1
0
0
3
0
0
0
0
0
```

Verify that the filter measurement noise, `ckf.MeasurementNoise`, is the same as the `detection.MeasurementNoise` values.

```
ckf.MeasurementNoise
```

```
ans = 3×3
```

```
1.0000    0.2000         0
0.2000    2.0000         0
         0         0    1.0000
```

Copyright 2018 The MathWorks, Inc.

Create Constant Acceleration Tracking CKF Object from Spherical Measurements

Create a constant acceleration tracking cubature Kalman filter object, `trackingCKF`, from an initial detection report. The detection report is made from an initial 3-D position measurement of the Kalman filter state in spherical coordinates. You can obtain the 3-D position measurement using the constant acceleration measurement function, `cameas`.

This example uses the coordinates, `az = 30`, `e1 = 5`, `r = 100`, `rr = 4` and a measurement noise of `diag([2.5, 2.5, 0.5, 1].^2)`.

```
meas = [30;5;100;4];
measNoise = diag([2.5, 2.5, 0.5, 1].^2);
```

Use the `MeasurementParameters` property of the detection object to define the frame. When not defined, the fields of the `MeasurementParameters` struct use default values. In this example, sensor position, sensor velocity, orientation, elevation, and range rate flags are default.

```
measParams = struct('Frame','spherical');
detection = objectDetection(0,meas,'MeasurementNoise',measNoise,...
    'MeasurementParameters',measParams)
```

```
detection =
    objectDetection with properties:
```



```

        Time: 0
        Measurement: [4x1 double]
        MeasurementNoise: [4x4 double]
        SensorIndex: 1
        ObjectClassID: 0
        MeasurementParameters: [1x1 struct]
        ObjectAttributes: {}

```

Use `initcckf` to create a `trackingCKF` filter initialized at the provided position and using the measurement noise defined above.

```
ckf = initcckf(detection)
```

```

ckf =
  trackingCKF with properties:

        State: [9x1 double]
        StateCovariance: [9x9 double]

        StateTransitionFcn: @constacc
        ProcessNoise: [3x3 double]
        HasAdditiveProcessNoise: 0

        MeasurementFcn: @cameas
        MeasurementNoise: [4x4 double]
        HasAdditiveMeasurementNoise: 1

        EnableSmoothing: 0

```

Verify that the filter state produces the same measurement as above.

```
meas2 = cameas(ckf.State, measParams)
```

```

meas2 = 4x1

    30.0000
     5.0000
    100.0000
     4.0000

```

Input Arguments

detection – Detection report

`objectDetection` object

Detection report, specified as an `objectDetection` object.

Example: `detection = objectDetection(0,[1;4.5;3],'MeasurementNoise', [1.0 0 0; 0 2.0 0; 0 0 1.5])`

Output Arguments

ckf — Constant acceleration cubature Kalman filter

trackingCKF object

Constant acceleration cubature Kalman filter for object tracking, returned as a trackingCKF object.

Algorithms

- The function computes the process noise matrix assuming a unit standard deviation for the acceleration change rate.
- You can use this function as the FilterInitializationFcn property of trackerTOMHT and trackerGNN System objects.

Extended Capabilities

C/C++ Code Generation

Generate C and C++ code using MATLAB® Coder™.

See Also

Functions

cameas | constacc | initcaekf | initcakf | initcaukf | initctekf | initctukf | initcvekf | initcvkf | initcvukf

Objects

objectDetection | trackerGNN | trackerTOMHT | trackingCKF | trackingEKF | trackingKF | trackingUKF

Introduced in R2018b

initcapf

Create constant acceleration tracking particle filter from detection report

Syntax

```
pf = initcapf(detection)
```

Description

`pf = initcapf(detection)` initializes a constant acceleration particle filter for object tracking based on information provided in an `objectDetection` object, `detection`.

The function initializes a constant acceleration state with the same convention as `constacc` and `cameas`, $[x; v_x; a_x; y; v_y; a_y; z; v_z; a_z]$.

Examples

Create Constant Acceleration Tracking PF Object from Rectangular Measurements

Create a constant acceleration tracking particle filter object, `trackingPF`, from an initial detection report. The detection report is made from an initial 3-D position measurement of the particle filter state in rectangular coordinates. You can obtain the 3-D position measurement using the constant acceleration measurement function, `cameas`.

This example uses the coordinates, $x = 1$, $y = 3$, $z = 0$ and a 3-D position measurement noise of $[1 \ 0.2 \ 0; \ 0.2 \ 2 \ 0; \ 0 \ 0 \ 1]$.

```
detection = objectDetection(0, [1;3;0], 'MeasurementNoise', [1 0.2 0; 0.2 2 0; 0 0 1]);
```

Use `initcapf` to create a `trackingPF` filter initialized at the provided position and using the measurement noise defined above.

```
pf = initcapf(detection)
```

```
pf =
  trackingPF with properties:
          State: [9x1 double]
      StateCovariance: [9x9 double]
  IsStateVariableCircular: [0 0 0 0 0 0 0 0 0]
          StateTransitionFcn: @constacc
      ProcessNoiseSamplingFcn: []
              ProcessNoise: [3x3 double]
  HasAdditiveProcessNoise: 0
          MeasurementFcn: @cameas
  MeasurementLikelihoodFcn: []
          MeasurementNoise: [3x3 double]
          Particles: [9x1000 double]
```

```

Weights: [1x1000 double]
ResamplingPolicy: [1x1 trackingResamplingPolicy]
ResamplingMethod: 'multinomial'

```

Check the values of the state and the measurement noise. Verify that the filter state, `pf.State`, has approximately the same position components as the detection measurement, `detection.Measurement`.

```
pf.State
```

```
ans = 9x1

    0.9674
    0.3690
    0.3827
    3.0317
    0.3056
   -0.5904
    0.0038
    0.0411
   -0.6815

```

Verify that the filter measurement noise, `pf.MeasurementNoise`, is the same as the `detection.MeasurementNoise` values.

```
pf.MeasurementNoise
```

```
ans = 3x3

    1.0000    0.2000         0
    0.2000    2.0000         0
         0         0    1.0000

```

Create Constant Acceleration Tracking PF Object from Spherical Measurements

Create a constant acceleration tracking particle filter object, `trackingPF`, from an initial detection report. The detection report is made from an initial 3-D position measurement of the particle filter state in spherical coordinates. You can obtain the 3-D position measurement using the constant acceleration measurement function, `cameas`.

This example uses the coordinates, `az = 30`, `e1 = 5`, `r = 100`, `rr = 4` and a measurement noise of `diag([2.5, 2.5, 0.5, 1].^2)`.

```
meas = [30;5;100;4];
measNoise = diag([2.5, 2.5, 0.5, 1].^2);
```

Use the `MeasurementParameters` property of the detection object to define the frame. When not defined, the fields of the `MeasurementParameters` struct use default values. In this example, sensor position, sensor velocity, orientation, elevation, and range rate flags are default.

```
measParams = struct('Frame', 'spherical');
detection = objectDetection(0, meas, 'MeasurementNoise', measNoise, ...
    'MeasurementParameters', measParams)
```

```
detection =
  objectDetection with properties:
        Time: 0
        Measurement: [4x1 double]
        MeasurementNoise: [4x4 double]
        SensorIndex: 1
        ObjectClassID: 0
        MeasurementParameters: [1x1 struct]
        ObjectAttributes: {}
```

Use `initcapf` to create a `trackingPF` filter initialized at the provided position and using the measurement noise defined above.

```
pf = initcapf(detection)

pf =
  trackingPF with properties:
        State: [9x1 double]
        StateCovariance: [9x9 double]
        IsStateVariableCircular: [0 0 0 0 0 0 0 0 0]

        StateTransitionFcn: @constacc
        ProcessNoiseSamplingFcn: []
        ProcessNoise: [3x3 double]
        HasAdditiveProcessNoise: 0

        MeasurementFcn: @cameas
        MeasurementLikelihoodFcn: []
        MeasurementNoise: [4x4 double]

        Particles: [9x1000 double]
        Weights: [1x1000 double]
        ResamplingPolicy: [1x1 trackingResamplingPolicy]
        ResamplingMethod: 'multinomial'
```

Verify that the filter state produces approximately the same measurement as `detection.Measurement`.

```
meas2 = cameas(pf.State, detection.MeasurementParameters)

meas2 = 4x1

    29.9188
     5.0976
    99.8303
     4.0255
```

Input Arguments

detection — Detection report
objectDetection object

Detection report, specified as an `objectDetection` object.

```
Example: detection = objectDetection(0,[1;4.5;3],'MeasurementNoise', [1.0 0 0;  
0 2.0 0; 0 0 1.5])
```

Output Arguments

pf — Constant acceleration particle filter

`trackingPF` object

Constant acceleration particle filter for object tracking, returned as a `trackingPF` object.

Algorithms

- The function configures the filter with 1000 particles. In creating the filter, the function computes the process noise matrix assuming a unit standard deviation for the acceleration change rate.
- You can use this function as the `FilterInitializationFcn` property of `trackerTOMHT` and `trackerGNN` System objects.

Extended Capabilities

C/C++ Code Generation

Generate C and C++ code using MATLAB® Coder™.

See Also

Functions

`cameas` | `constacc` | `initcackf` | `initcaekf` | `initcakf` | `initcaukf` | `initctpf` | `initcvpf`

Objects

`objectDetection` | `trackerGNN` | `trackerTOMHT` | `trackingEKF` | `trackingKF` | `trackingPF` | `trackingUKF`

Introduced in R2018b

initcvckf

Create constant velocity tracking cubature Kalman filter from detection report

Syntax

```
ckf = initcvckf(detection)
```

Description

`ckf = initcvckf(detection)` initializes a constant velocity cubature Kalman filter for object tracking based on information provided in an `objectDetection` object, `detection`.

The function initializes a constant velocity state with the same convention as `constvel` and `cvmeas`, $[x; v_x; y; v_y; z; v_z]$.

Examples

Create Constant Velocity Tracking CKF Object from Rectangular Measurements

Create a constant velocity tracking cubature Kalman filter object, `trackingCKF`, from an initial detection report. The detection report is made from an initial 3-D position measurement of the Kalman filter state in rectangular coordinates. You can obtain the 3-D position measurement using the constant velocity measurement function, `cvmeas`.

This example uses the coordinates, $x = 1$, $y = 3$, $z = 0$ and a 3-D position measurement noise of $[1 \ 0.2 \ 0; 0.2 \ 2 \ 0; 0 \ 0 \ 1]$.

```
detection = objectDetection(0, [1;3;0], 'MeasurementNoise', [1 0.2 0; 0.2 2 0; 0 0 1]);
```

Use `initcvckf` to create a `trackingCKF` filter initialized at the provided position and using the measurement noise defined above.

```
ckf = initcvckf(detection)
```

```
ckf =
  trackingCKF with properties:
        State: [6x1 double]
    StateCovariance: [6x6 double]
    StateTransitionFcn: @constvel
        ProcessNoise: [3x3 double]
    HasAdditiveProcessNoise: 0
        MeasurementFcn: @cvmeas
    MeasurementNoise: [3x3 double]
    HasAdditiveMeasurementNoise: 1
        EnableSmoothing: 0
```

Check the values of the state and the measurement noise. Verify that the filter state, `ckf.State`, has the same position components as the detection measurement, `detection.Measurement`.

```
ckf.State
```

```
ans = 6×1
```

```
1
0
3
0
0
0
```

Verify that the filter measurement noise, `ckf.MeasurementNoise`, is the same as the `detection.MeasurementNoise` values.

```
ckf.MeasurementNoise
```

```
ans = 3×3
```

```
1.0000    0.2000    0
0.2000    2.0000    0
0         0        1.0000
```

Create Constant Velocity Tracking CKF Object from Spherical Measurements

Create a constant velocity tracking cubature Kalman filter object, `trackingCKF`, from an initial detection report. The detection report is made from an initial 3-D position measurement of the Kalman filter state in spherical coordinates. You can obtain the 3D position measurement using the constant velocity measurement function, `cvmeas`.

This example uses the coordinates, `az = 30`, `e1 = 5`, `r = 100`, `rr = 4` and a measurement noise of `diag([2.5, 2.5, 0.5, 1].^2)`.

```
meas = [30;5;100;4];
measNoise = diag([2.5, 2.5, 0.5, 1].^2);
```

Use the `MeasurementParameters` property of the detection object to define the frame. When not defined, the fields of the `MeasurementParameters` struct use default values. In this example, sensor position, sensor velocity, orientation, elevation, and range rate flags are default.

```
measParams = struct('Frame', 'spherical');
detection = objectDetection(0, meas, 'MeasurementNoise', measNoise, ...
    'MeasurementParameters', measParams)
```

```
detection =
    objectDetection with properties:
```

```
Time: 0
Measurement: [4x1 double]
MeasurementNoise: [4x4 double]
SensorIndex: 1
```



```

    ObjectClassID: 0
    MeasurementParameters: [1x1 struct]
    ObjectAttributes: {}

```

Use `initcvckf` to create a `trackingCKF` filter initialized at the provided position and using the measurement noise defined above.

```

ckf = initcvckf(detection)

ckf =
    trackingCKF with properties:

        State: [6x1 double]
        StateCovariance: [6x6 double]

        StateTransitionFcn: @constvel
        ProcessNoise: [3x3 double]
        HasAdditiveProcessNoise: 0

        MeasurementFcn: @cvmeas
        MeasurementNoise: [4x4 double]
        HasAdditiveMeasurementNoise: 1

        EnableSmoothing: 0

```

Verify that the filter state produces the same measurement as above.

```
meas2 = cvmeas(ckf.State, measParams)
```

```
meas2 = 4x1
```

```

    30.0000
     5.0000
    100.0000
     4.0000

```

Input Arguments

detection – Detection report

`objectDetection` object

Detection report, specified as an `objectDetection` object.

Example: `detection = objectDetection(0,[1;4.5;3],'MeasurementNoise', [1.0 0 0; 0 2.0 0; 0 0 1.5])`

Output Arguments

ckf – Constant velocity cubature Kalman filter for object tracking

`trackingCKF` object

Constant velocity cubature Kalman filter for object tracking, returned as a `trackingCKF` object.

Algorithms

- The function computes the process noise matrix assuming a unit acceleration standard deviation.
- You can use this function as the `FilterInitializationFcn` property of `trackerTOMHT` and `trackerGNN` System objects.

Extended Capabilities

C/C++ Code Generation

Generate C and C++ code using MATLAB® Coder™.

See Also

Functions

`constvel` | `cvmeas` | `cvmeasjac` | `initcackf` | `initcaekf` | `initcakf` | `initcaukf` | `initctckf` | `initctekf` | `initctukf` | `initcvekf` | `initcvkf` | `initcvukf`

Objects

`objectDetection` | `trackerGNN` | `trackerTOMHT` | `trackingCKF` | `trackingEKF` | `trackingKF` | `trackingUKF`

Introduced in R2018b

initcvpf

Create constant velocity tracking particle filter from detection report

Syntax

```
pf = initcvpf(detection)
```

Description

`pf = initcvpf(detection)` initializes a constant velocity particle filter for object tracking based on information provided in an `objectDetection` object, `detection`.

The function initializes a constant velocity state with the same convention as `constvel` and `cvmeas`, $[x; v_x; y; v_y; z; v_z]$.

Examples

Create Constant Velocity Tracking PF Object from Rectangular Measurements

Create a constant velocity tracking particle filter object, `trackingPF`, from an initial detection report. The detection report is made from an initial 3-D position measurement of the particle filter state in rectangular coordinates. You can obtain the 3-D position measurement using the constant velocity measurement function, `cvmeas`.

This example uses the coordinates, $x = 1$, $y = 3$, $z = 0$ and a 3-D position measurement noise of $[1 \ 0.2 \ 0; \ 0.2 \ 2 \ 0; \ 0 \ 0 \ 1]$.

```
detection = objectDetection(0, [1;3;0], 'MeasurementNoise', [1 0.2 0; 0.2 2 0; 0 0 1]);
```

Use `initcvpf` to create a `trackingPF` filter initialized at the provided position and using the measurement noise defined above.

```
pf = initcvpf(detection)
```

```
pf =
  trackingPF with properties:
          State: [6x1 double]
    StateCovariance: [6x6 double]
  IsStateVariableCircular: [0 0 0 0 0 0]
          StateTransitionFcn: @constvel
    ProcessNoiseSamplingFcn: []
              ProcessNoise: [3x3 double]
    HasAdditiveProcessNoise: 0
          MeasurementFcn: @cvmeas
    MeasurementLikelihoodFcn: []
              MeasurementNoise: [3x3 double]
          Particles: [6x1000 double]
```

```

Weights: [1x1000 double]
ResamplingPolicy: [1x1 trackingResamplingPolicy]
ResamplingMethod: 'multinomial'

```

Check the values of the state and the measurement noise. Verify that the filter state, `pf.State`, has approximately the same position components as the detection measurement, `detection.Measurement`.

```
pf.State
```

```

ans = 6x1

    0.9674
    0.3690
    3.0471
    0.2733
    0.0306
   -0.5904

```

Verify that the filter measurement noise, `pf.MeasurementNoise`, is the same as the `detection.MeasurementNoise` values.

```
pf.MeasurementNoise
```

```

ans = 3x3

    1.0000    0.2000         0
    0.2000    2.0000         0
         0         0    1.0000

```

Create Constant Velocity Tracking PF Object from Spherical Measurements

Create a constant velocity tracking particle filter object, `trackingPF`, from an initial detection report. The detection report is made from an initial 3-D position measurement of the particle filter state in spherical coordinates. You can obtain the 3-D position measurement using the constant velocity measurement function, `cvmeas`.

This example uses the coordinates, `az = 30`, `e1 = 5`, `r = 100`, `rr = 4` and a measurement noise of `diag([2.5, 2.5, 0.5, 1].^2)`.

```

meas = [30;5;100;4];
measNoise = diag([2.5, 2.5, 0.5, 1].^2);

```

Use the `MeasurementParameters` property of the detection object to define the frame. When not defined, the fields of the `MeasurementParameters` struct use default values. In this example, sensor position, sensor velocity, orientation, elevation, and range rate flags are default.

```

measParams = struct('Frame','spherical');
detection = objectDetection(0,meas,'MeasurementNoise',measNoise,...
    'MeasurementParameters',measParams)

```

```

detection =
    objectDetection with properties:

```

```

        Time: 0
        Measurement: [4x1 double]
        MeasurementNoise: [4x4 double]
        SensorIndex: 1
        ObjectClassID: 0
        MeasurementParameters: [1x1 struct]
        ObjectAttributes: {}

```

Use `initcvpf` to create a `trackingPF` filter initialized at the provided position and using the measurement noise defined above.

```
pf = initcvpf(detection)
```

```
pf =
```

```
trackingPF with properties:
```

```

        State: [6x1 double]
        StateCovariance: [6x6 double]
        IsStateVariableCircular: [0 0 0 0 0 0]

        StateTransitionFcn: @constvel
        ProcessNoiseSamplingFcn: []
        ProcessNoise: [3x3 double]
        HasAdditiveProcessNoise: 0

        MeasurementFcn: @cvmeas
        MeasurementLikelihoodFcn: []
        MeasurementNoise: [4x4 double]

        Particles: [6x1000 double]
        Weights: [1x1000 double]
        ResamplingPolicy: [1x1 trackingResamplingPolicy]
        ResamplingMethod: 'multinomial'

```

Verify that the filter state produces approximately the same measurement as `detection.Measurement`.

```
meas2 = cvmeas(pf.State, detection.MeasurementParameters)
```

```
meas2 = 4x1
```

```

29.9188
 5.0976
99.8303
 4.0255

```

Input Arguments

detection – Detection report

`objectDetection` object

Detection report, specified as an `objectDetection` object.

```
Example: detection = objectDetection(0,[1;4.5;3],'MeasurementNoise', [1.0 0 0;  
0 2.0 0; 0 0 1.5])
```

Output Arguments

pf — Constant velocity particle filter

trackingPF object

Constant velocity particle filter for object tracking, returned as a trackingPF object.

Algorithms

- The function configures the filter with 1000 particles. In creating the filter, the function computes the process noise matrix assuming a unit acceleration standard deviation.
- You can use this function as the FilterInitializationFcn property of trackerTOMHT and trackerGNN System objects.

Extended Capabilities

C/C++ Code Generation

Generate C and C++ code using MATLAB® Coder™.

See Also

Functions

constvel | cvmeas | initcapf | initctpf | initcvckf | initcvekf | initcvkf | initcvukf

Objects

objectDetection | trackerGNN | trackerTOMHT | trackingEKF | trackingKF | trackingPF | trackingUKF

Introduced in R2018b

initctckf

Create constant turn rate tracking cubature Kalman filter from detection report

Syntax

```
ckf = initctckf(detection)
```

Description

`ckf = initctckf(detection)` initializes a constant turn rate cubature Kalman filter for object tracking based on information provided in an `objectDetection` object, `detection`.

The function initializes a constant turn-rate state with the same convention as `constturn` and `ctmeas`, $[x; v_x; y; v_y; \omega; z; v_z]$, where ω is the turn-rate.

Examples

Create Constant Turn Rate Tracking CKF Object from Rectangular Measurements

Create a turn rate tracking cubature Kalman filter object, `trackingCKF`, from an initial detection report. The detection report is made from an initial 3-D position measurement of the Kalman filter state in rectangular coordinates. You can obtain the 3-D position measurement using the constant turn rate measurement function, `ctmeas`.

This example uses the coordinates, $x = 1$, $y = 3$, $z = 0$ and a 3-D position measurement noise of $[1 \ 0.2 \ 0; 0.2 \ 2 \ 0; 0 \ 0 \ 1]$.

```
detection = objectDetection(0, [1;3;0], 'MeasurementNoise', [1 0.2 0; 0.2 2 0; 0 0 1]);
```

Use `initctckf` to create a `trackingCKF` filter initialized at the provided position and using the measurement noise defined above.

```
ckf = initctckf(detection)
```

```
ckf =
  trackingCKF with properties:
        State: [7x1 double]
    StateCovariance: [7x7 double]
    StateTransitionFcn: @constturn
        ProcessNoise: [4x4 double]
    HasAdditiveProcessNoise: 0
        MeasurementFcn: @ctmeas
    MeasurementNoise: [3x3 double]
    HasAdditiveMeasurementNoise: 1
        EnableSmoothing: 0
```

Check the values of the state and the measurement noise. Verify that the filter state, `ckf.State`, has the same position components as the detection measurement, `detection.Measurement`.

```
ckf.State
```

```
ans = 7×1
```

```
1
0
3
0
0
0
0
```

Verify that the filter measurement noise, `ckf.MeasurementNoise`, is the same as the `detection.MeasurementNoise` values.

```
ckf.MeasurementNoise
```

```
ans = 3×3
```

```
1.0000    0.2000         0
0.2000    2.0000         0
         0         0    1.0000
```

Create Constant Turn Rate Tracking CKF Object from Spherical Measurements

Create a constant turn rate tracking cubature Kalman filter object, `trackingCKF`, from an initial detection report. The detection report is made from an initial 3-D position measurement of the Kalman filter state in spherical coordinates. You can obtain the 3-D position measurement using the constant turn rate measurement function, `ctmeas`.

This example uses the coordinates, `az = 30`, `e1 = 5`, `r = 100`, `rr = 4` and a measurement noise of `diag([2.5, 2.5, 0.5, 1].^2)`.

```
meas = [30;5;100;4];
measNoise = diag([2.5, 2.5, 0.5, 1].^2);
```

Use the `MeasurementParameters` property of the detection object to define the frame. When not defined, the fields of the `MeasurementParameters` struct use default values. In this example, sensor position, sensor velocity, orientation, elevation, and range rate flags are default.

```
measParams = struct('Frame','spherical');
detection = objectDetection(0,meas,'MeasurementNoise',measNoise,...
    'MeasurementParameters',measParams)
```

```
detection =
    objectDetection with properties:
        Time: 0
        Measurement: [4x1 double]
        MeasurementNoise: [4x4 double]
```



```

        SensorIndex: 1
        ObjectClassID: 0
    MeasurementParameters: [1x1 struct]
    ObjectAttributes: {}

```

Use `initctckf` to create a `trackingCKF` filter initialized at the provided position and using the measurement noise defined above.

```

ckf = initctckf(detection)

ckf =
    trackingCKF with properties:

        State: [7x1 double]
        StateCovariance: [7x7 double]

        StateTransitionFcn: @constturn
        ProcessNoise: [4x4 double]
        HasAdditiveProcessNoise: 0

        MeasurementFcn: @ctmeas
        MeasurementNoise: [4x4 double]
        HasAdditiveMeasurementNoise: 1

        EnableSmoothing: 0

```

Verify that the filter state produces the same measurement as above.

```

meas2 = ctmeas(ckf.State, measParams)

meas2 = 4x1

    30.0000
     5.0000
    100.0000
     4.0000

```

Input Arguments

detection — Detection report

`objectDetection` object

Detection report, specified as an `objectDetection` object.

Example: `detection = objectDetection(0,[1;4.5;3],'MeasurementNoise',[1.0 0 0; 0 2.0 0; 0 0 1.5])`

Output Arguments

ckf — Constant turn rate cubature Kalman filter for object tracking

`trackingCKF` object

Constant turn rate cubature Kalman filter for object tracking, returned as a `trackingCKF` object.

Algorithms

- The function computes the process noise matrix assuming a unit acceleration standard deviation and a unit angular acceleration standard deviation.
- You can use this function as the `FilterInitializationFcn` property of `trackerTOMHT` and `trackerGNN` System objects.

Extended Capabilities

C/C++ Code Generation

Generate C and C++ code using MATLAB® Coder™.

See Also

Functions

`constturn` | `ctmeas` | `initcackf` | `initcaekf` | `initcakf` | `initcaukf` | `initctekf` | `initctukf` | `initcvckf` | `initcvekf` | `initcvkf` | `initcvukf`

Objects

`objectDetection` | `trackerGNN` | `trackerTOMHT` | `trackingCKF` | `trackingEKF` | `trackingKF` | `trackingUKF`

Introduced in R2018b

initctpf

Create constant turn rate tracking particle filter from detection report

Syntax

```
pf = initctpf(detection)
```

Description

`pf = initctpf(detection)` initializes a constant turn rate particle filter for object tracking based on information provided in an `objectDetection` object, `detection`.

The function initializes a constant turn-rate state with the same convention as `constturn` and `ctmeas`, $[x; v_x; y; v_y; \omega; z; v_z]$, where ω is the turn-rate.

Examples

Create Constant Turn Rate Tracking PF Object from Rectangular Measurements

Create a constant turn rate tracking particle filter object, `trackingPF`, from an initial detection report. The detection report is made from an initial 3-D position measurement of the particle filter state in rectangular coordinates. You can obtain the 3-D position measurement using the constant turn rate measurement function, `ctmeas`.

This example uses the coordinates, $x = 1$, $y = 3$, $z = 0$ and a 3-D position measurement noise of $[1 \ 0.2 \ 0; \ 0.2 \ 2 \ 0; \ 0 \ 0 \ 1]$.

```
detection = objectDetection(0, [1;3;0], 'MeasurementNoise', [1 0.2 0; 0.2 2 0; 0 0 1]);
```

Use `initctpf` to create a `trackingPF` filter initialized at the provided position and using the measurement noise defined above.

```
pf = initctpf(detection)
```

```
pf =
  trackingPF with properties:
          State: [7x1 double]
    StateCovariance: [7x7 double]
  IsStateVariableCircular: [0 0 0 0 0 0 0]
          StateTransitionFcn: @constturn
    ProcessNoiseSamplingFcn: []
              ProcessNoise: [4x4 double]
    HasAdditiveProcessNoise: 0
          MeasurementFcn: @ctmeas
    MeasurementLikelihoodFcn: []
              MeasurementNoise: [3x3 double]
          Particles: [7x1000 double]
```

```

Weights: [1x1000 double]
ResamplingPolicy: [1x1 trackingResamplingPolicy]
ResamplingMethod: 'multinomial'

```

Check the values of the state and the measurement noise. Verify that the filter state, `pf.State`, has approximately the same position components as the detection measurement, `detection.Measurement`.

```
pf.State
```

```
ans = 7x1

    0.9674
    0.3690
    3.0471
    0.2733
    0.3056
   -0.0590
    0.0382

```

Verify that the filter measurement noise, `pf.MeasurementNoise`, is the same as the `detection.MeasurementNoise` values.

```
pf.MeasurementNoise
```

```
ans = 3x3

    1.0000    0.2000         0
    0.2000    2.0000         0
         0         0    1.0000

```

Create Constant Turn Rate Tracking PF Object from Spherical Measurements

Create a constant turn rate tracking particle filter object, `trackingPF`, from an initial detection report. The detection report is made from an initial 3-D position measurement of the particle filter state in spherical coordinates. You can obtain the 3D position measurement using the constant turn rate measurement function, `ctmeas`.

This example uses the coordinates, `az = 30`, `e1 = 5`, `r = 100`, `rr = 4` and a measurement noise of `diag([2.5, 2.5, 0.5, 1].^2)`.

```
meas = [30;5;100;4];
measNoise = diag([2.5, 2.5, 0.5, 1].^2);
```

Use the `MeasurementParameters` property of the detection object to define the frame. When not defined, the fields of the `MeasurementParameters` struct use default values. In this example, sensor position, sensor velocity, orientation, elevation, and range rate flags are default.

```
measParams = struct('Frame','spherical');
detection = objectDetection(0,meas,'MeasurementNoise',measNoise,...
    'MeasurementParameters',measParams)
```

```
detection =
  objectDetection with properties:
        Time: 0
        Measurement: [4x1 double]
        MeasurementNoise: [4x4 double]
        SensorIndex: 1
        ObjectClassID: 0
        MeasurementParameters: [1x1 struct]
        ObjectAttributes: {}
```

Use `initctpf` to create a `trackingPF` filter initialized at the provided position and using the measurement noise defined above.

```
pf = initctpf(detection)

pf =
  trackingPF with properties:
        State: [7x1 double]
        StateCovariance: [7x7 double]
        IsStateVariableCircular: [0 0 0 0 0 0 0]

        StateTransitionFcn: @constturn
        ProcessNoiseSamplingFcn: []
        ProcessNoise: [4x4 double]
        HasAdditiveProcessNoise: 0

        MeasurementFcn: @ctmeas
        MeasurementLikelihoodFcn: []
        MeasurementNoise: [4x4 double]

        Particles: [7x1000 double]
        Weights: [1x1000 double]
        ResamplingPolicy: [1x1 trackingResamplingPolicy]
        ResamplingMethod: 'multinomial'
```

Verify that the filter state produces approximately the same measurement as `detection.Measurement`.

```
meas2 = ctmeas(pf.State, detection.MeasurementParameters)

meas2 = 4x1

    29.9188
     5.0976
    99.8303
     4.0255
```

Input Arguments

detection — Detection report
objectDetection object

Detection report, specified as an `objectDetection` object.

```
Example: detection = objectDetection(0,[1;4.5;3],'MeasurementNoise', [1.0 0 0;  
0 2.0 0; 0 0 1.5])
```

Output Arguments

pf — Constant turn rate particle filter

`trackingPF` object

Constant turn rate particle filter for object tracking, returned as a `trackingPF` object.

Algorithms

- The function configures the filter with 1000 particles. In creating the filter, the function computes the process noise matrix assuming a unit acceleration standard deviation and a unit angular acceleration standard deviation.
- You can use this function as the `FilterInitializationFcn` property of `trackerTOMHT` and `trackerGNN` System objects.

Extended Capabilities

C/C++ Code Generation

Generate C and C++ code using MATLAB® Coder™.

See Also

Functions

`constturn` | `ctmeas` | `initcapf` | `initctckf` | `initctekf` | `initctukf` | `initcvpf`

Objects

`objectDetection` | `trackerGNN` | `trackerTOMHT` | `trackingEKF` | `trackingKF` | `trackingPF` | `trackingUKF`

Introduced in R2018b

initcaggiwphd

Create constant acceleration ggiwphd filter

Syntax

```
phd = initcaggiwphd
phd = initcaggiwphd(detections)
```

Description

`phd = initcaggiwphd` initializes a constant acceleration ggiwphd filter with no zeros components in the filter.

`phd = initcaggiwphd(detections)` initializes a constant acceleration ggiwphd filter based on information provided in object detections, `detections`. The function initializes a constant acceleration state with the same convention as `constacc` and `cameas`, $[x;v_x;a_x;y;v_y;a_y;z;v_z;a_z]$.

Note This initialization function is not compatible with `trackerGNN`, `trackerJPDA`, and `trackerTOMHT` system objects.

Examples

Initialize Constant Acceleration ggiwphd filter

Consider an object located at position [1;2;3] with detections uniformly spread around it's extent. The size of the extent is 1.2, 2.3 and 3.5 in x, y and z directions, respectively.

```
detections = cell(20,1);
location = [1;2;3];
dimensions = [1.2;2.3;3.5];
rng(2018) % Reproducible results
measurements = location + dimensions.*(-1 + 2*rand(3,20));
for i = 1:20
    detections{i} = objectDetection(0,measurements(:,i));
end
```

Initialize a constant acceleration ggiwphd filter with the generated detections.

```
phd = initcaggiwphd(detections);
```

Check the filter has the same position estimates as the mean of measurements.

```
states = phd.States
```

```
states = 9×1
```

```
    1.2856
         0
         0
```

```
1.9950
  0
  0
2.9779
  0
  0
```

```
measurementMean = mean(measurements,2)
```

```
measurementMean = 3×1
```

```
1.2856
1.9950
2.9779
```

Check the extent and expected number of detections.

```
extent = phd.ScaleMatrices/(phd.DegreesOfFreedom - 4)
```

```
extent = 3×3
```

```
1.4603    0.0885   -0.2403
0.0885    3.0050   -0.0225
-0.2403   -0.0225    4.8365
```

```
expDetections = phd.Shapes/phd.Rates
```

```
expDetections = 20
```

Input Arguments

detections — Object detections

cell array of `objectDetection` objects

Object detections, specified as a cell array of `objectDetection` objects. You can create detections directly, or you can obtain detections from the outputs of sensor objects, such as `radarSensor`, `monostaticRadarSensor`, `irSensor`, and `sonarSensor`.

Example: `detection = objectDetection(0,[1;4.5;3],'MeasurementNoise',[1.0 0 0; 0 2.0 0; 0 0 1.5])`

Output Arguments

phd — `ggiwphd` filter

`ggiwphd` object

`ggiwphd` filter, returned as a `ggiwphd` object.

Algorithms

- You can use `initcaggiwphd` as the `FilterInitializationFcn` property of `trackingSensorConfiguration`.

- When detections are provided as input, the function adds one component to the density which reflects the mean of the detections. When the function is called without any inputs, a filter is initialized with no components in the density.
- The function uses the spread of measurements to describe the Inverse-Wishart distribution.
- The function uses the number of detections to describe the Gamma distribution.
- The function configures the process noise of the filter by assuming a unit standard deviation for the acceleration change rate.
- The function specifies a maximum of 500 components in the filter.

Extended Capabilities

C/C++ Code Generation

Generate C and C++ code using MATLAB® Coder™.

See Also

[ggiwphd](#) | [initctggiwphd](#) | [initcvggiwphd](#) | [trackerPHD](#)

Introduced in R2019a

initctggiwphd

Create constant turn-rate ggiwphd filter

Syntax

```
phd = initctggiwphd
phd = initctggiwphd(detections)
```

Description

`phd = initctggiwphd` initializes a constant turn-rate ggiwphd filter with zero components in the filter.

`phd = initctggiwphd(detections)` initializes a constant turn-rate ggiwphd filter based on information provided in object detections, `detections`. The function initializes a constant turn-rate state with the same convention as `constturn` and `ctmeas`, $[x;v_x;y;v_y;\omega;z;v_z]$, where ω is the turn-rate.

Note This initialization function is not compatible with `trackerGNN`, `trackerJPDA`, and `trackerTOMHT` system objects.

Examples

Initialize Constant Turn-Rate ggiwphd filter

Consider an object located at position [1;2;3] with detections uniformly spread around it's extent. The size of the extent is 1.2, 2.3 and 3.5 in x, y and z directions, respectively.

```
detections = cell(20,1);
location = [1;2;3];
dimensions = [1.2;2.3;3.5];
rng(2018) % Reproducible results
measurements = location + dimensions.*(-1 + 2*rand(3,20));
for i = 1:20
    detections{i} = objectDetection(0,measurements(:,i));
end
```

Initialize a constant turn-rate ggiwphd filter with the generated detections.

```
phd = initctggiwphd(detections);
```

Check the values of state in the filter has the same position estimates as the mean of measurements.

```
states = phd.States
```

```
states = 7×1
    1.2856
         0
```

```

1.9950
  0
  0
2.9779
  0

```

```
measurementMean = mean(measurements,2)
```

```
measurementMean = 3x1
```

```

1.2856
1.9950
2.9779

```

Check the extent and expected number of detections.

```
extent = phd.ScaleMatrices/(phd.DegreesOfFreedom - 4)
```

```
extent = 3x3
```

```

1.4603    0.0885   -0.2403
0.0885    3.0050   -0.0225
-0.2403   -0.0225    4.8365

```

```
expDetections = phd.Shapes/phd.Rates
```

```
expDetections = 20
```

Input Arguments

detections — Object detections

cell array of `objectDetection` objects

Object detections, specified as a cell array of `objectDetection` objects. You can create `detections` directly, or you can obtain detections from the outputs of sensor objects, such as `radarSensor`, `monostaticRadarSensor`, `irSensor`, and `sonarSensor`.

Example: `detection = objectDetection(0,[1;4.5;3],'MeasurementNoise',[1.0 0 0; 0 2.0 0; 0 0 1.5])`

Output Arguments

phd — ggiwphd filter

ggiwphd object

ggiwphd filter, returned as a ggiwphd object.

Algorithms

- You can use `initctggiwphd` as the `FilterInitializationFcn` property of `trackingSensorConfiguration`.

- When detections are provided as input, the function adds one component to the density which reflects the mean of the detections. When the function is called without any inputs, a filter is initialized with no components in the density.
- The function uses the spread of measurements to describe the Inverse-Wishart distribution.
- The function uses the number of detections to describe the Gamma distribution.
- The function configures the process noise of the filter by assuming a unit angular acceleration standard deviation.
- The function specifies a maximum of 500 components in the filter.

Extended Capabilities

C/C++ Code Generation

Generate C and C++ code using MATLAB® Coder™.

See Also

`ggiwphd` | `initcaggiwphd` | `initcvggiwphd` | `trackerPHD`

Introduced in R2019a

initcvggiwphd

Create constant velocity ggiwphd filter

Syntax

```
phd = initcvggiwphd
phd = initcvggiwphd(detections)
```

Description

`phd = initcvggiwphd` initializes a constant velocity ggiwphd filter with zero components in the filter.

`phd = initcvggiwphd(detections)` initializes a constant velocity ggiwphd filter based on information provided in object detections, `detections`. The function initializes a constant velocity state with the same convention as `constvel` and `cvmeas`, $[x;v_x;y;v_y;z;v_z]$.

Note This initialization function is not compatible with `trackerGNN`, `trackerJPDA`, and `trackerTOMHT` system objects.

Examples

Initialize Constant Velocity ggiwphd filter

Consider an object located at position `[1;2;3]` with detections uniformly spread around it's extent. The size of the extent is 1.2, 2.3 and 3.5 in x, y and z directions, respectively.

```
detections = cell(20,1);
location = [1;2;3];
dimensions = [1.2;2.3;3.5];
rng(2018) % Reproducible results
measurements = location + dimensions.*(-1 + 2*rand(3,20));
for i = 1:20
    detections{i} = objectDetection(0,measurements(:,i));
end
```

Initialize a constant velocity ggiwphd filter with the generated detections.

```
phd = initcvggiwphd(detections);
```

Check the values of state in the filter has the same position estimates as the mean of measurements.

```
states = phd.States
```

```
states = 6×1
    1.2856
         0
    1.9950
```

```
0
2.9779
0
```

```
measurementMean = mean(measurements,2)
```

```
measurementMean = 3×1
```

```
1.2856
1.9950
2.9779
```

Check the extent and expected number of detections.

```
extent = phd.ScaleMatrices/(phd.DegreesOfFreedom - 4)
```

```
extent = 3×3
```

```
1.4603    0.0885   -0.2403
0.0885    3.0050   -0.0225
-0.2403   -0.0225    4.8365
```

```
expDetections = phd.Shapes/phd.Rates
```

```
expDetections = 20
```

Input Arguments

detections — Object detections

cell array of `objectDetection` objects

Object detections, specified as a cell array of `objectDetection` objects. You can create detections directly, or you can obtain detections from the outputs of sensor objects, such as `radarSensor`, `monostaticRadarSensor`, `irSensor`, and `sonarSensor`.

Example: `detection = objectDetection(0,[1;4.5;3],'MeasurementNoise',[1.0 0 0; 0 2.0 0; 0 0 1.5])`

Output Arguments

phd — ggiwphd filter

ggiwphd object

ggiwphd filter, returned as a ggiwphd object.

Algorithms

- You can use `initcvggiwphd` as the `FilterInitializationFcn` property of `trackingSensorConfiguration`.
- When detections are provided as input, the function adds one component to the density which reflects the mean of the detections. When the function is called without any inputs, a filter is initialized with no components in the density.

- The function uses the spread of measurements to describe the Inverse-Wishart distribution.
- The function uses the number of detections to describe the Gamma distribution.
- The function configures the process noise of the filter by assuming a unit acceleration standard deviation.
- The function specifies a maximum of 500 components in the filter.

Extended Capabilities

C/C++ Code Generation

Generate C and C++ code using MATLAB® Coder™.

See Also

ggiwphd | initcaggiwphd | initctggiwphd | trackerPHD

Introduced in R2019a

initcagmphd

Create constant acceleration gmphd filter

Syntax

```
phd = initcagmphd
phd = initcagmphd(detections)
```

Description

`phd = initcagmphd` initializes a constant acceleration gmphd filter with zero components in the filter.

`phd = initcagmphd(detections)` initializes a constant acceleration gmphd filter based on information provided in object detections, `detections`. The function initializes a constant acceleration state with the same convention as `constacc` and `cameas`, $[x; v_x; a_x; y; v_y; a_y; z; v_z; a_z]$.

Note This initialization function is not compatible with `trackerGNN`, `trackerJPDA`, and `trackerTOMHT` System objects.

Examples

Initialize Constant Acceleration gmphd Filter for Point Target

Consider a point target located at $[1;2;3]$. Create detection for the target using `objectDetection`.

```
detection = objectDetection(0,[1;2;3]);
```

Initialize a constant acceleration gmphd filter using `initcagmphd`.

```
phd = initcagmphd(detection);
```

Illustrate the initial state and the extent setup of the phd filter.

```
state = phd.States
```

```
state = 9×1
```

```
1
0
0
2
0
0
3
0
0
```



```
extent = phd.HasExtent
```

```
extent = logical
      0
```

Initialize Constant Acceleration gmphp Filter for Extended Object

Consider an extended object located at [1;2;3]. The object's detections are uniformly distributed in x-, y-, and z-directions with dimensions of 1.2, 2.3, and 3.5, respectively. Generate 20 randomly distributed detections for the object using `objectDetection`.

```
detections = cell(20,1);
location = [1;2;3];
dimensions = [1.2;2.3;3.5];
rng(2019);
measurements = location + dimensions.*(-1 + 2*rand(3,20));
for i = 1:20
    detections{i} = objectDetection(0,measurements(:,i));
end
```

Initialize a constant acceleration gmphp filter using `initcagmphp`.

```
phd = initcagmphp(detections);
```

The initial state of the filter is same as the mean of the measurements.

```
state = phd.States
```

```
state = 9×1
```

```
    1.1034
         0
         0
    2.5597
         0
         0
    2.4861
         0
         0
```

```
mean_measure = mean(measurements,2)
```

```
mean_measure = 3×1
```

```
    1.1034
    2.5597
    2.4861
```

By default, the function sets the `HasExtent` property to true if the number of measurements is greater than 1.

```
extent = phd.HasExtent
```

```
extent = logical  
    1
```

Input Arguments

detections — Object detections

cell array of `objectDetection` objects

Object detections, specified as a cell array of `objectDetection` objects. You can create detections directly, or you can obtain detections from the outputs of sensor objects, such as `radarSensor`, `monostaticRadarSensor`, `irSensor`, and `sonarSensor`.

Example: `detection = objectDetection(0,[1;4.5;3],'MeasurementNoise',[1.0 0 0; 0 2.0 0; 0 0 1.5])`

Output Arguments

phd — gmphd filter

gmphd object

Gaussian mixture PHD filter, returned as a gmphd object.

Algorithms

- You can use `initcagmphd` as the `FilterInitializationFcn` property of `trackingSensorConfiguration`.
- When detections are provided as input, the function adds one component to the density, which reflects the mean of the detections. When the function is called without any inputs, a filter is initialized with no components in the density.
- The function uses the spread of measurements to specify the positional covariance.
- The function configures the process noise of the filter by assuming a unit standard deviation for the acceleration change rate.
- The function specifies a maximum of 500 components in the filter.
- The function sets the `HasExtent` property of the filter to `true` if the number of input detections are greater than one.

Extended Capabilities

C/C++ Code Generation

Generate C and C++ code using MATLAB® Coder™.

See Also

`gmphd` | `initctgmphd` | `initcvgmphd` | `trackerPHD`

Introduced in R2019b

initctgmphd

Create constant turn-rate gmphd filter

Syntax

```
phd = initctgmphd
phd = initctgmphd(detections)
```

Description

`phd = initctgmphd` initializes a constant turn-rate gmphd filter with zero components in the filter.

`phd = initctgmphd(detections)` initializes a constant turn-rate gmphd filter based on information provided in object detections, `detections`. The function initializes a constant turn-rate state with the same convention as `constturn` and `ctmeas`, $[x; v_x; y; v_y; \omega; z; v_z]$, where ω is the turn-rate.

Note This initialization function is not compatible with `trackerGNN`, `trackerJPDA`, and `trackerTOMHT` System objects.

Examples

Initialize Constant Turn-Rate gmphd Filter for Point Target

Consider a point target located at $[1;2;3]$. Create detection for the target using `objectDetection`.

```
detection = objectDetection(0,[1;2;3]);
```

Initialize a constant turn-rate gmphd filter using `initctgmphd`.

```
phd = initctgmphd(detection);
```

Display the initial state and the extent setup of the filter.

```
state = phd.States
```

```
state = 7×1
```

```
1
0
2
0
0
3
0
```

```
extent = phd.HasExtent
```

```
extent = logical
0
```

Initialize Constant Turn-Rate gmphd Filter for Extended Object

Consider an extended object located at [1;2;3]. The object's detections are uniformly distributed in x-, y-, and z-directions with dimensions of 1.2, 2.3, and 3.5, respectively. Generate 20 randomly distributed detections for the object using `objectDetection`.

```
detections = cell(20,1);
location = [1;2;3];
dimensions = [1.2;2.3;3.5];
rng(2019);
measurements = location + dimensions.*(-1 + 2*rand(3,20));
for i = 1:20
    detections{i} = objectDetection(0,measurements(:,i));
end
```

Initialize a constant turn-rate gmphd filter using `initctgmphd`.

```
phd = initctgmphd(detections);
```

The initial state of the filter is same as the mean of the measurements.

```
state = phd.States
```

```
state = 7×1
```

```
1.1034
0
2.5597
0
0
2.4861
0
```

```
mean_measure = mean(measurements,2)
```

```
mean_measure = 3×1
```

```
1.1034
2.5597
2.4861
```

By default, the function sets the `HasExtent` property to true if the number of measurements is greater than 1.

```
extent = phd.HasExtent
```

```
extent = logical
1
```

Input Arguments

detections — Object detections

cell array of `objectDetection` objects

Object detections, specified as a cell array of `objectDetection` objects. You can create detections directly, or you can obtain detections from the outputs of sensor objects, such as `radarSensor`, `monostaticRadarSensor`, `irSensor`, and `sonarSensor`.

Example: `detection = objectDetection(0,[1;4.5;3],'MeasurementNoise',[1.0 0 0; 0 2.0 0; 0 0 1.5])`

Output Arguments

phd — gmphd filter

gmphd object

Gaussian mixture PHD filter, returned as a gmphd object.

Algorithms

- You can use `initctgmphd` as the `FilterInitializationFcn` property of `trackingSensorConfiguration`.
- When detections are provided as input, the function adds one component to the density, which reflects the mean of the detections. When the function is called without any inputs, a filter is initialized with no components in the density.
- The function uses the spread of measurements to specify the positional covariance.
- The function configures the process noise of the filter by assuming a unit acceleration standard deviation and a unit angular acceleration standard deviation.
- The function specifies a maximum of 500 components in the filter.
- The function sets the `HasExtent` property of the filter to `true` if the number of input detections are greater than one.

Extended Capabilities

C/C++ Code Generation

Generate C and C++ code using MATLAB® Coder™.

See Also

`gmphd` | `initcagmphd` | `initcvgmphd` | `trackerPHD`

Introduced in R2019b

initcvgmphd

Create constant velocity gmphd filter

Syntax

```
phd = initcvgmphd
phd = initcvgmphd(detections)
```

Description

`phd = initcvgmphd` initializes a constant velocity gmphd filter with zero components in the filter.

`phd = initcvgmphd(detections)` initializes a constant velocity gmphd filter based on information provided in object detections, `detections`. The function initializes a constant velocity state with the same convention as `constvel` and `cvmeas`, $[x; v_x; y; v_y; z; v_z]$.

Note This initialization function is not compatible with `trackerGNN`, `trackerJPDA`, and `trackerTOMHT` System objects.

Examples

Initialize Constant Velocity gmphd Filter for Point Target

Consider a point target located at `[1;2;3]`. Create a detection for the target using `objectDetection`.

```
detection = objectDetection(0,[1;2;3]);
```

Initialize a constant velocity gmphd filter using `initcvgmphd`.

```
phd = initcvgmphd(detection);
```

Display the initial state and the extent setup of the gmphd filter.

```
state = phd.States
```

```
state = 6x1
```

```
    1
    0
    2
    0
    3
    0
```

```
extent = phd.HasExtent
```

```
extent = logical
0
```

Initialize Constant Velocity gmphd Filter for Extended Object

Consider an extended object located at [1;2;3]. The object's detections are uniformly distributed in x-, y-, and z-directions with dimensions of 1.2, 2.3, and 3.5, respectively. Generate 20 randomly distributed detections for the object using `objectDetection`.

```
detections = cell(20,1);
location = [1;2;3];
dimensions = [1.2;2.3;3.5];
rng(2019);
measurements = location + dimensions.*(-1 + 2*rand(3,20));
for i = 1:20
    detections{i} = objectDetection(0,measurements(:,i));
end
```

Initialize a constant velocity gmphd filter using `initcvgmphd`.

```
phd = initcvgmphd(detections);
```

The initial state of the filter is same as the mean of the measurements.

```
state = phd.States
```

```
state = 6×1
    1.1034
         0
    2.5597
         0
    2.4861
         0
```

```
mean_measure = mean(measurements,2)
```

```
mean_measure = 3×1
    1.1034
    2.5597
    2.4861
```

By default, the function sets the `HasExtent` property to true if the number of measurements is larger than 1.

```
extent = phd.HasExtent
```

```
extent = logical
1
```

Input Arguments

detections — Object detections

cell array of `objectDetection` objects

Object detections, specified as a cell array of `objectDetection` objects. You can create detections directly, or you can obtain detections from the outputs of sensor objects, such as `radarSensor`, `monostaticRadarSensor`, `irSensor`, and `sonarSensor`.

Example: `detection = objectDetection(0,[1;4.5;3],'MeasurementNoise',[1.0 0 0; 0 2.0 0; 0 0 1.5])`

Output Arguments

phd — gmphd filter

gmphd object

Gaussian mixture PHD filter, returned as a gmphd object.

Algorithms

- You can use `initcvgmphd` as the `FilterInitializationFcn` property of `trackingSensorConfiguration`.
- When detections are provided as input, the function adds one component to the density, which reflects the mean of the detections. When the function is called without any inputs, a filter is initialized with no components in the density.
- The function uses the spread of measurements to specify the positional covariance.
- The function configures the process noise of the filter by assuming a unit acceleration standard deviation.
- The function specifies a maximum of 500 components in the filter.
- The function sets the `HasExtent` property of the filter to `true` if the number of input detections are greater than one.

Extended Capabilities

C/C++ Code Generation

Generate C and C++ code using MATLAB® Coder™.

See Also

`gmphd` | `initcagmphd` | `initctgmphd` | `trackerPHD`

Introduced in R2019b

initctrectgmphd

Create constant turn-rate rectangular target gmphd filter

Syntax

```
phd = initctrectgmphd
phd = initctrectgmphd(detections)
```

Description

`phd = initctrectgmphd` initializes a constant turn-rate rectangular target gmphd filter with zero components in the filter.

`phd = initctrectgmphd(detections)` initializes a constant turn-rate rectangular target gmphd filter based on information provided in object detections, `detections`. The function initializes a constant turn-rate rectangular state with the same convention as `ctrect` and `ctrectmeas`, $[x; y; s; \theta; \omega; L; W]$. See “Algorithms” on page 1-306 for the meaning of these variables.

Note This initialization function is not compatible with `trackerGNN`, `trackerJPDA`, and `trackerTOMHT` System objects.

Examples

Initialize gmphd for Rectangular Target

Load detections generated by a rectangular target and the corresponding truth.

```
load ('rectangularTargetDetections', 'detections', 'truthState');
```

Initialize the filter using detections.

```
phd = initctrectgmphd(detections);
```

Display the estimated state and the truth state.

```
estState = phd.States
```

```
estState = 7×1
```

```
-0.0688
49.2233
    0
    0
    0
 3.3942
 0.9871
```

truthState

```
truthState = 7×1
```

```
    0  
50.0000  
    0  
30.0000  
    0  
 4.7000  
 1.8000
```

Input Arguments

detections — Object detections

cell array of `objectDetection` objects

Object detections, specified as a cell array of `objectDetection` objects. You can create detections directly, or you can obtain detections from the outputs of sensor objects, such as `radarSensor`, `monostaticRadarSensor`, `irSensor`, and `sonarSensor`.

Example: `detection = objectDetection(0,[1;4.5;3],'MeasurementNoise',[1.0 0 0; 0 2.0 0; 0 0 1.5])`

Output Arguments

phd — gmphd filter

gmphd object

Gaussian mixture PHD filter, returned as a gmphd object.

Algorithms

Initialization Process

- You can use `initctrectgmphd` as the `FilterInitializationFcn` property of `trackingSensorConfiguration`.
- When detections are provided as input, the function adds one component to the density, which reflects the mean of the detections. When the function is called without any inputs, a filter is initialized with no components in the density.
- The function uses the spread of measurements to specify the length and width of the rectangle.
- The function configures the process noise of the filter by assuming a unit acceleration and a unit yaw-acceleration standard deviation.
- The function specifies a maximum of 500 components in the filter.
- The function configures the covariance of the state using a unit covariance in observed dimensions.

Rectangular Target State

The rectangular target state contains $[x; y; s;\theta; \omega; L; W]$:

Variable	Meaning	Unit
x	Position of the rectangle center in x direction	m
y	Position of the rectangle center in y direction	m
s	Speed in the heading direction	m/s
θ	Orientation angle of the rectangle with respect to x direction	degree
ω	Turn-rate	degree/s
L	Length of the rectangle	m
W	Width of the rectangle	m

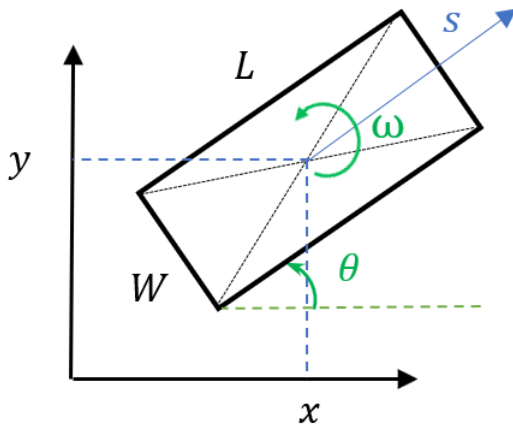

Extended Capabilities

C/C++ Code Generation

Generate C and C++ code using MATLAB® Coder™.

See Also

`ctrect` | `ctrectcorners` | `ctrectjac` | `ctrectmeas` | `ctrectmeasjac` | `gmphd` | `initcagmphd` | `initctgmphd` | `initctrectgmphd` | `trackerPHD`

Introduced in R2019b

initsingerekf

Singer acceleration trackingEKF initialization

Syntax

```
filter = initsingerekf(detection)
```

Description

`filter = initsingerekf(detection)` initializes a Singer acceleration extended Kalman filter (trackingEKF) based on the detection input.

The function initializes an acceleration state $[x; v_x; a_x; y; v_y; a_y; z; v_z; a_z]$ in the filter.

Examples

Initialize Singer Acceleration Extended Kalman Filter in Rectangular Frame

For a rectangular frame, the Singer acceleration measurement function, `singermeas`, assumes a position measurement in 3-D space. Define a position measurement `[1;3;0]` that has measurement noise `[1 0.2 0; 0.2 2 0; 0 0 1]`.

```
detection = objectDetection(0, [1;3;0],...
    'MeasurementNoise', [1 0.2 0; 0.2 2 0; 0 0 1]);
```

Use the `initsingerekf` function to create a `trackingEKF` filter using the measurements defined above.

```
ekf = initsingerekf(detection);
```

Verify the values of the state and measurement noise.

```
filterState = ekf.State
```

```
filterState = 9×1
```

```
1
0
0
3
0
0
0
0
0
```

```
filterMeasureNoise = ekf.MeasurementNoise
```

```
filterMeasureNoise = 3×3
```

```

1.0000  0.2000  0
0.2000  2.0000  0
0        0      1.0000

```

Input Arguments

detection — Object detection

`objectDetection` object

Object detection, specified as an `objectDetection` object. You can specify the following fields for the `MeasurementParameters` property of the `objectDetection` object. When you do not specify a field, the default value is used.

Field	Description	Default Value
Frame	Frame used to report measurements, specified as one of these values: <ul style="list-style-type: none"> 'rectangular' — Detections are reported in rectangular coordinates. 'spherical' — Detections are reported in spherical coordinates. 	'rectangular'
OriginPosition	Position offset of the origin of the frame relative to the parent frame, specified as an [x y z] real-valued vector.	[0 0 0]
OriginVelocity	Velocity offset of the origin of the frame relative to the parent frame, specified as a [vx vy vz] real-valued vector.	[0 0 0]
Orientation	Frame rotation matrix, specified as a 3-by-3 real-valued orthonormal matrix.	[1 0 0; 0 1 0; 0 0 1]
HasAzimuth	Logical scalar indicating if azimuth is included in the measurement.	1
HasElevation	Logical scalar indicating if elevation is included in the measurement. For measurements reported in a rectangular frame, and if <code>HasElevation</code> is false, the reported measurements assume 0 degrees of elevation.	1

Field	Description	Default Value
HasRange	Logical scalar indicating if range is included in the measurement.	1
HasVelocity	Logical scalar indicating if the reported detections include velocity measurements. For measurements reported in the rectangular frame, if HasVelocity is false, the measurements are reported as [x y z]. If HasVelocity is true, measurements are reported as [x y z vx vy vz].	0
IsParentToChild	Logical scalar indicating if Orientation performs a frame rotation from the parent coordinate frame to the child coordinate frame. When IsParentToChild is false, then Orientation performs a frame rotation from the child coordinate frame to the parent coordinate frame.	0

Output Arguments

filter — Extended Kalman filter

trackingEKF object

Extended Kalman filter, returned as a trackingEKF object.

Algorithms

- You can use the `initsingerekf` function as the `FilterInitializationFcn` property of `trackingEKF`.
- When creating the Kalman filter, the function configures the process noise assuming a target maneuver time constant, $\tau = 20\text{s}$ and a unit target maneuver standard deviation, $\sigma = 1 \text{ m/s}^2$. The function uses the `singerProcessNoise` function.
- The Singer process noise assumes an invariant time step and additive process noise.

References

- [1] Singer, Robert A. "Estimating optimal tracking filter performance for manned maneuvering targets." IEEE Transactions on Aerospace and Electronic Systems 4 (1970): 473-483.
- [2] Blackman, Samuel S., and Robert Popoli. "Design and analysis of modern tracking systems." (1999).

- [3] Li, X. Rong, and Vesselin P. Jilkov. "Survey of maneuvering target tracking: dynamic models." Signal and Data Processing of Small Targets 2000, vol. 4048, pp. 212-235. International Society for Optics and Photonics, 2000.

Extended Capabilities

C/C++ Code Generation

Generate C and C++ code using MATLAB® Coder™.

Usage notes and limitations:

- The function returns a filter that uses anonymous functions to define the `StateTransitionFcn` and `StateTransitionCovarianceFcn` properties. As a result, the value of the target maneuver constant ($\tau = 20$ s) cannot be modified after construction. To create a Singer-based filter with a different value of τ , you must write your own filter initialization function similar as the `initsingerekf` function.

See Also

`singer` | `singerProcessNoise` | `singerjac` | `singermeas` | `singermeasjac`

Introduced in R2020b

ctrectcorners

Corner measurements of constant turn-rate rectangular target

Syntax

```
zCorners = ctrectcorners(states)
zCorners = ctrectcorners(states, sensorParameters)
```

Description

`zCorners = ctrectcorners(states)` returns the positions of the corners for constant turn-rate rectangular targets in a rectangular frame.

`zCorners = ctrectcorners(states, sensorParameters)` specifies the parameters of the sensor that measures the corners of rectangular targets.

Examples

Position of Corners in Sensor Reference Frame

Define sensor reference frame by specifying the `sensorParameters` input.

```
sensorPosition = [-5;10;0];
sensorOrientation = rotmat(Quaternion([30 0 0], 'eulerd', 'ZYX', 'frame'), 'frame');
sensorParams = struct('Frame', 'Rectangular', ...
    'OriginPosition', sensorPosition, ...
    'Orientation', sensorOrientation);
```

Define the constant turn-rate state for the rectangle target.

```
state = [10;5;1.6;30;0.5;4.7;1.8];
```

Compute corner positions in sensor reference frame.

```
corners = ctrectcorners(state, sensorParams);
```

Set up visualization environment using `theaterPlot`.

```
% Create a theater plot.
tp = theaterPlot;
% Plot the state using a track plotter.
statePlotter = trackPlotter(tp, 'DisplayName', 'Target State');
% Plot the corners using a detection plotter.
cornerPlotter = detectionPlotter(tp, 'DisplayName', 'Corners');
```

Compute inputs and plot.

```
targetPos = [state(1) state(2) 0];
targetOrientation = rotmat(Quaternion([state(4) 0 0], 'eulerd', 'ZYX', 'frame'), 'frame');
targetDims = struct('Length', state(6), ...
    'Width', state(7), ...
```



```

    'Height',5,...
    'OriginOffset',[0 0 0]);

cornerPosGlobal = sensorOrientation*corners(:, :) + sensorPosition;
statePlotter.plotTrack(targetPos,targetDims,targetOrientation);
cornerPlotter.plotDetection(cornerPosGlobal');

```

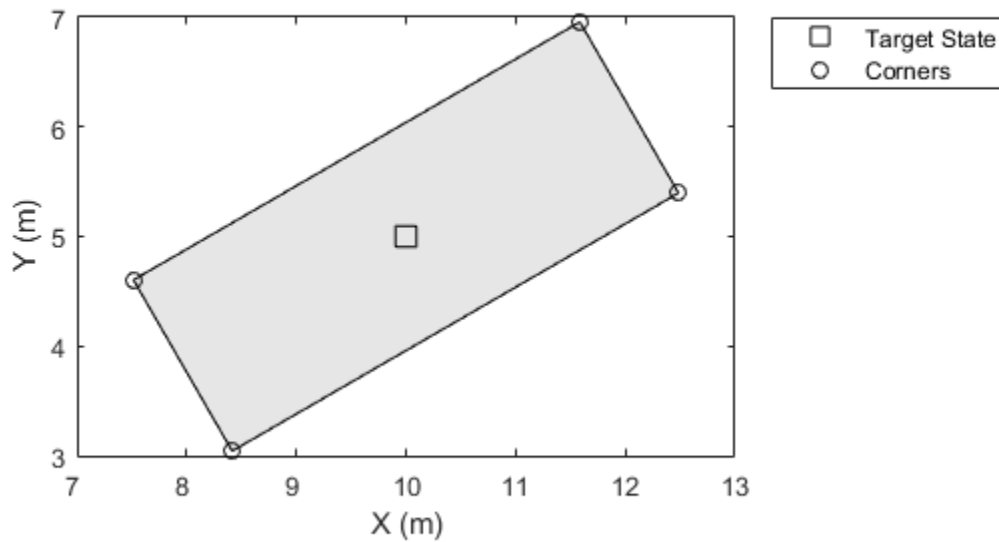

Input Arguments

states — Current rectangular target states

7-by- N real-valued matrix

Current rectangular target states, specified as a 7-by- N real-valued matrix, where N is the number of states. The seven dimensional rectangular state is defined as $[x; y; s; \theta; \omega; L; W]$. The meaning of these variables and their units are:

Variable	Meaning	Unit
x	Position of the rectangle center in x direction	m
y	Position of the rectangle center in y direction	m
s	Speed in the heading direction	m/s

θ	Orientation angle of the rectangle with respect to x direction	degree
ω	Turn-rate	degree/s
L	Length of the rectangle	m
W	Width of the rectangle	m

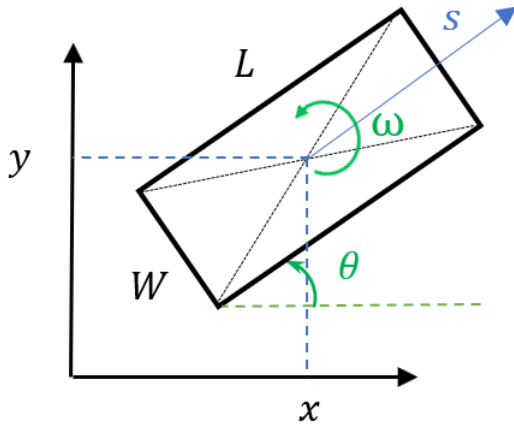

Example: [1;2;2;30;1;4.7;1.8]

Data Types: single | double

sensorParameters — Parameters for sensor transform function

structure | array of structures

Parameters for the sensor transform function, returned as a structure or an array of structures. If you only need to transform the state once, specify it as a structure. If you need to transform the state n times, specify it as an n -by-1 array of structures. For example, to transform a state from the scenario frame to the sensor frame, you usually need to first transform the state from the scenario rectangular frame to the platform rectangular frame, and then transform the state from the platform rectangular frame to the sensor spherical frame.

The fields of the structure are:

Field	Description
Frame	Child coordinate frame type, specified as 'Rectangular' or 'Spherical'.
OriginPosition	Child frame origin position expressed in the parent frame, specified as a 3-by-1 vector.
OriginVelocity	Child frame origin velocity expressed in the parent frame, specified as a 3-by-1 vector.

Orientation	Relative orientation between frames, specified as a 3-by-3 rotation matrix. If the <code>IsParentToChild</code> property is set to <code>false</code> , then specify <code>Orientation</code> as the rotation from the child frame to the parent frame. If the <code>IsParentToChild</code> property is set to <code>true</code> , then specify <code>Orientation</code> as the rotation from the parent frame to the child frame.
IsParentToChild	Flag to indicate the direction of rotation between parent and child frame, specified as <code>true</code> or <code>false</code> . The default is <code>false</code> . See description of the <code>Orientation</code> field for details.
HasAzimuth	Indicates whether outputs contain azimuth components, specified as <code>true</code> or <code>false</code> .
HasElevation	Indicates whether outputs contain elevation components, specified as <code>true</code> or <code>false</code> .
HasRange	Indicates whether outputs contain range components, specified as <code>true</code> or <code>false</code> .
HasVelocity	Indicates whether outputs contain velocity components, specified as <code>true</code> or <code>false</code> .

Note that here the scenario frame is the parent frame of the platform frame, and the platform frame is the parent frame of the sensor frame.

When frame is 'Rectangular', `HasVelocity` determines if the measurement is returned in the form of $[x; y; z; v_x; v_y; v_z]$ or $[x; y; z]$.

When frame is 'spherical', the returned measurements are in the order of [azimuth, elevation, range, range-rate]. The elements of the returned measurements are determined by:

- `HasAzimuth` — Determines if output contains azimuth measurement.
- `HasElevation` — Determines if output contains elevation measurement.
- `HasRange` — Determines if output contains range measurement.
- `HasVelocity` — Determines if output contains range-rate measurement on the condition that `HasRange` is 'true'. If `HasRange` is 'false', the returned measurement does not contain range-rate (even though `HasVelocity` is 'true').

Data Types: `struct`

Output Arguments

zCorners — States of corners

real-valued M -by- N -by-4 array.

States of corners, returned as a real-valued M -by- N -by-4 array. Each page (an M -by- N matrix) of the array corresponds to one corner for all the states given in the states input. N is the number of states. M is the dimension of output specified by the `sensorParameters` input. If unspecified, the default value of M is three, which corresponds to 3-D Cartesian position coordinates.

Extended Capabilities

C/C++ Code Generation

Generate C and C++ code using MATLAB® Coder™.

See Also

[ctrect](#) | [ctrectjac](#) | [ctrectmeas](#) | [ctrectmeasjac](#) | [gmphd](#) | [initctrectgmphd](#) | [trackerPHD](#)

Introduced in R2018b

switchimm

Model conversion function for `trackingIMM` object

Syntax

```
x = switchimm(modelType1,x1,modelType2)
x = switchimm( ___,x2)
```

Description

`x = switchimm(modelType1,x1,modelType2)` converts the `State` or `StateCovariance` properties of the `trackingIMM` object from `modelType1` state definition to `modelType2` state definition.

- `modelType1` -- Specifies the string name of the current motion model.
- `x1` -- Specifies `State` or `StateCovariance` corresponding to `modelType1`.
- `modelType2` -- Specifies the string name of the motion model to which `x1` needs to be converted.

`x = switchimm(___,x2)` additionally lets you specify the size and type of the output. When not specified, `x` has the same data type and dimensionality as `x1`.

`x2` specifies `State` or `StateCovariance` corresponding to `modelType2`.

Examples

Convert State from Constant Acceleration to Constant Velocity

Convert state from constant acceleration model to constant velocity model using the `switchimm` function.

Initialization

Set the current model to `'constacc'` and the destination model to `'constvel'`. The variable `x1` defines the state in the current model.

```
modelType1 = 'constacc';
modelType2 = 'constvel';
x1 = single([1;2;3;4;5;6]);
```

Conversion

The `switchimm` function converts the 2-D constant acceleration state input to a 2-D constant velocity state output. The output has the same dimensionality and data type as the input `x1`.

```
x = switchimm(modelType1,x1,modelType2)
```

x = 4x1 single column vector

```
1
2
```

4
5

Convert State from Constant Acceleration to Constant Turn

Convert state from constant acceleration model to constant turn model using the `switchimm` function. Specify `x2` as an input parameter.

Initialization

Set the current model to `'constacc'` and the destination model to `'constturn'`. The variable `x1` defines the state in the current model. The size and data type of the output is determined by the optional input `x2`.

```
modelType1 = 'constacc';  
modelType2 = 'constturn';  
x1 = [1;2;3;4;5;6];  
x2 = [0;0;0;0;0;0;0];
```

Conversion

The `switchimm` function converts the 2-D constant acceleration state input to a 3-D constant turn model state output. The output has the same size and data type as the input `x2`.

```
x = switchimm(modelType1,x1,modelType2,x2)
```

```
x = 7×1
```

```
1  
2  
4  
5  
0  
0  
0
```

Input Arguments

`modelType1` — Current motion model

`'constvel'` | `'constacc'` | `'constturn'`

Current motion model, specified as:

- `'constvel'` -- Constant velocity motion model.
- `'constacc'` -- Constant-acceleration motion model.
- `'constturn'` -- Constant turn-rate motion model.

`x1` — State or state covariance of current model

vector | matrix

State vector or state covariance matrix corresponding to the current model in `modelType1`, specified as an L -by-1 real vector or an L -by- L real matrix.

The size of the state vector must fit the motion model. For example, if the `modelType` is `'constvel'`, the state vector must be of size 2, 4, or 6. Similarly, if the `modelType` is `'constacc'`, the state vector must be of size 3, 6, or 9. If the `modelType` is `'constturn'`, the state vector must be of size 5, 7, 10, 15, 14, or 21. The relationship between model type, state size, and the space dimension is given by the following table:

modelType1	Supported Space Dimension	State size
'constvel'	1-D, 2-D, 3-D	2 × Space dimension
'constacc'	1-D, 2-D, 3-D	3 × Space dimension
'constturn'	2-D and 3-D	5 for 2-D space and 7 for 3-D space

The `'constturn'` model type supports only 2-D and 3-D spaces, since a turn cannot be made in 1-D space. If the space dimension is computed to be 1-D, that is, the state size equals 5 or 7, the function treats the output dimension as 2 and the values corresponding to the second dimension are set to 0. For example, run the following in the MATLAB® command prompt:

```
switchimm('constvel', rand(2,1), 'constturn')
```

Data Types: `single` | `double`

modelType2 — Motion model to which x1 needs to be converted

`'constvel'` | `'constacc'` | `'constturn'`

Motion model to which `x1` needs to be converted, specified as:

- `'constvel'` -- Constant velocity motion model.
- `'constacc'` -- Constant-acceleration motion model.
- `'constturn'` -- Constant turn-rate motion model.

x2 — Specify size and type of output state or state covariance

`vector` | `matrix`

The optional input `x2` has the same size and data type as the output state vector or the state covariance matrix, `x`. The variable `x2` does not contain the actual output state information, but only holds the size and the data type of the output state. For example, when `x2` is set to `[0;0;0;0;0;0]`, the function determines the output state vector to be a vector of size 7 with a data type of `double`.

The size of the state vector must fit the motion model. For example, if the `modelType` is `'constvel'`, the state vector must be of size 2, 4, or 6. Similarly, if the `modelType` is `'constacc'`, the state vector must be of size 3, 6, or 9. The relationship between model type, state size, and the space dimension is given by the following table:

modelType1	Supported Space Dimension	State size
'constvel'	1-D, 2-D, 3-D	2 × Space dimension
'constacc'	1-D, 2-D, 3-D	3 × Space dimension
'constturn'	2-D and 3-D	5 for 2-D space and 7 for 3-D space

Example: `[0;0;0;0;0;0]`

Data Types: `single` | `double`

Output Arguments

x — State or state covariance corresponding to `modelType2`

vector | matrix

State vector or state covariance matrix, corresponding to the motion model specified in `modelType2`.

The relationship between model type, state size, and the space dimension is given by the following table:

modelType1	Supported Space Dimension	State size
'constvel'	1-D, 2-D, 3-D	2 × Space dimension
'constacc'	1-D, 2-D, 3-D	3 × Space dimension
'constturn'	2-D and 3-D	5 for 2-D space and 7 for 3-D space

If x2 is not specified:

Given `modelType1` and `x1`, the function determines the input state dimension based on the relationship specified in the table. For example, if `modelType1` is 'constvel', and `x1` is a 4-by-1 vector, the input state dimension is given by $4/2$, which equals 2.

If `modelType1` is 'constacc' and `x1` is a 6-by-1 vector, the input state dimension is given by $6/3$, which equals 2.

In this case when `x2` is not specified, the output `x` has the same data type as `x1` and the dimension is calculated using `modelType1` and `x1`.

If x2 is specified:

The function calculates the output space dimension using `modelType2` and `x2`. For example, if `modelType2` is 'constacc' and `x2` is a 6-by-1 vector, the output state dimension is given by $6/3$, which equals 2.

The output `x` has the same data type and dimensionality as `x2`.

Extended Capabilities

C/C++ Code Generation

Generate C and C++ code using MATLAB® Coder™.

See Also

Objects

trackingIMM

Functions

constacc | constturn | constvel | initcvmscekf

Introduced in R2018b

initcvmscekf

Constant velocity trackingMSCEKF initialization

Syntax

```
mscekf = initcvmscekf(detection)
mscekf = initcvmscekf(detection,rangeEstimation)
```

Description

`mscekf = initcvmscekf(detection)` initializes a `trackingMSCEKF` class (extended Kalman filter for tracking in modified spherical coordinates) based on information provided in an `objectDetection` object, `detection`. The function assumes a target range of $3e^4$ units and a range-covariance of $1e^{10}$ units².

The `trackingMSCEKF` object can be used with trackers for tracking targets with angle-only measurements from a single observer.

`mscekf = initcvmscekf(detection,rangeEstimation)` allows specifying the range information to the filter. The `rangeEstimation` variable is a two-element vector, where the first element specifies the range of the target, and the second element specifies the standard deviation in range.

Examples

Initialize a trackingMSCEKF Object Using Angle-Only Detection

Create an angle-only detection.

```
detection = objectDetection(0,[30;20], 'MeasurementParameters', ...
    struct('Frame', 'Spherical', 'HasRange', false));
```

Use `initcvmscekf` to create a `trackingMSCEKF` filter initialized using the angle-only detection.

```
filter = initcvmscekf(detection)

filter =
    trackingMSCEKF with properties:
        State: [6x1 double]
        StateCovariance: [6x6 double]
        StateTransitionFcn: @constvelmsc
        StateTransitionJacobianFcn: @constvelmscjac
        ProcessNoise: [3x3 double]
        HasAdditiveProcessNoise: 0
        ObserverInput: [3x1 double]
        MeasurementFcn: @cvmeasmsc
        MeasurementJacobianFcn: @cvmeasmscjac
```

```
MeasurementNoise: [2x2 double]
HasAdditiveMeasurementNoise: 1
```

Initialize trackingMSCEKF Object with Detection from Rotating Sensor

Create measurement parameters for subsequent rotation.

```
measParamSensorToPlat = struct('Frame','Spherical','HasRange',false,...
'Orientation',rotmat( quaternion([0 0 30], 'rotvecd'), 'frame'))

measParamSensorToPlat = struct with fields:
    Frame: 'Spherical'
    HasRange: 0
    Orientation: [3x3 double]

measParamPlatToScenario = struct('Frame','Rectangular','HasRange',false,...
'Orientation',rotmat( quaternion([30 0 0], 'rotvecd'), 'frame'))

measParamPlatToScenario = struct with fields:
    Frame: 'Rectangular'
    HasRange: 0
    Orientation: [3x3 double]
```

```
measParam = [measParamSensorToPlat;measParamPlatToScenario];
detection = objectDetection(0,[30;20], 'MeasurementParameters',measParam);
```

Initialize a filter.

```
filter = initcvmsckf(detection);
```

Check that filter's measurement is same as detection.

```
cvmeasmsc(filter.State,measParam)
```

```
ans = 2x1
    30.0000
    20.0000
```

Track a Constant Velocity Target Using trackerGNN

Consider a scenario when the target is moving at a constant velocity along and the observer is moving at a constant acceleration. Define target's initial state using a constant velocity model.

```
tgtState = [2000;-3;500;-5;0;0];
```

Define observer's initial state using a constant acceleration model.

```
observerState = [0;2;0;490;-10;0.2;0;0;0];
```

Create a `trackerGNN` object to use with `initcvmsckf` with some prior information about range and range-covariance.

```
range = 1000;
rangeStdDev = 1e3;
rangeEstimate = [range rangeStdDev];
tracker = trackerGNN('FilterInitializationFcn',@(det)initcvmsckf(det,rangeEstimate));
```

Simulate synthetic data by using measurement models. Get `az` and `e1` information using the `cvmeas` function.

```
syntheticParams = struct('Frame','Spherical','HasRange',false,...
    'OriginPosition',observerState(1:3:end));
meas = cvmeas(tgtState,syntheticParams);
```

Create an angle-only object `Detection` to simulate synthetic detection.

```
detection = objectDetection(0,meas,'MeasurementParameters',...
    struct('Frame','Spherical','HasRange',false),'MeasurementNoise',0.033*eye(2));
```

Create `trackPlotter` and `platformPlotter` to visualize the scenario.

```
tp = theaterPlot('XLimits',[0 2500],'YLimits',[0 1000]);
targetPlotter = platformPlotter(tp,'DisplayName','Target','MarkerFaceColor','k');
observerPlotter = platformPlotter(tp,'DisplayName','Observer','MarkerFaceColor','r');
trkPlotter = trackPlotter(tp,'DisplayName','Track','MarkerFaceColor','g','HistoryDepth',50);
tgtTrajPlotter = trajectoryPlotter(tp,'DisplayName','Target Trajectory','Color','k');
obsTrajPlotter = trajectoryPlotter(tp,'DisplayName','Observer Trajectory','Color','r');
```

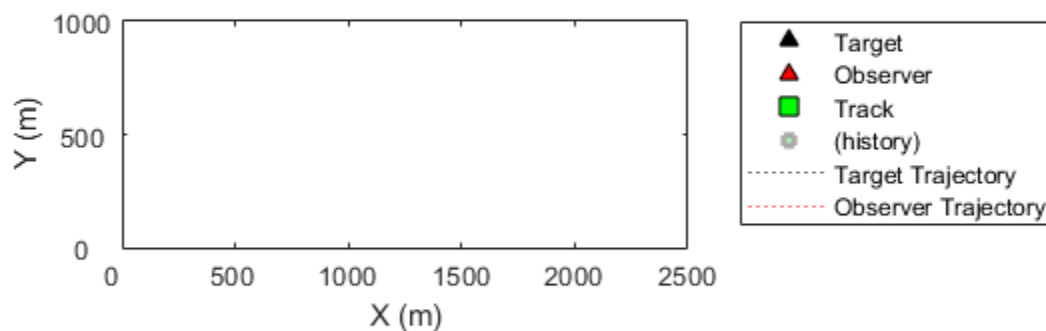

Run the tracker.

```
time = 0; dT = 0.1;
tgtPoses = [];
obsPoses = [];
while time < 50
    [confTracks,tentTracks,allTracks] = tracker(detection,time);
    for i = 1:numel(allTracks)
        setTrackFilterProperties(tracker,allTracks(i).TrackID,'ObserverInput',observerState(3:3:
    end

    % Update synthetic detection.
    observerState = constacc(observerState,dT);
    tgtState = constvel(tgtState,dT);
    syntheticParams.OriginPosition = observerState(1:3:end);
    detection.Measurement = cvmeas(tgtState,syntheticParams);
    time = time + dT;
    detection.Time = time;

    % Update plots
    tgtPoses = [tgtPoses;tgtState(1:2:end)']; %#ok
    obsPoses = [obsPoses;observerState(1:3:end)']; %#ok
    targetPlotter.plotPlatform(tgtState(1:2:end)');
    observerPlotter.plotPlatform(observerState(1:3:end)');
    tgtTrajPlotter.plotTrajectory({tgtPoses});
    obsTrajPlotter.plotTrajectory({obsPoses});
    % Plot the first track as there are no false alarms, this should be
    % the target.
    % Get positions from the MSC state of the track.
    cartState = cvmeasmsc(allTracks(i).State,'rectangular') + observerState(1:3:end);
    trkPlotter.plotTrack(cartState');
end
```

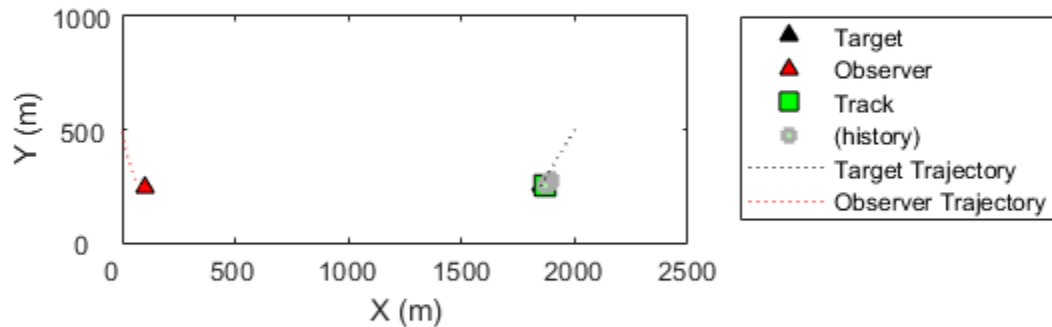

Input Arguments

detection — Detection report

`objectDetection` object

Detection report, specified as an `objectDetection` object.

Example: `detection = objectDetection(0,[1;4.5;3],'MeasurementNoise',[1.0 0 0; 0 2.0 0; 0 0 1.5])`

rangeEstimation — Range information

two-element vector

Range information, specified as a two-element vector, where the first element specifies the range of the target, and the second element specifies the standard deviation in range.

Data Types: `single` | `double`

Output Arguments

msckf — Constant velocity tracking extended Kalman filter in MSC frame

`trackingMSCEKF` object

Constant velocity tracking extended Kalman filter in an MSC frame, returned as a `trackingMSCEKF` object.

Algorithms

- The function configures the filter with process noise assuming a unit target acceleration standard deviation.
- The function configures the covariance of the state in an MSC frame by using a linear transformation of covariance in a Cartesian frame.
- You can use this function as the `FilterInitializationFcn` property of `trackerTOMHT` and `trackerGNN` System objects.
- The function initializes the `ObserverInput` of the `trackingMSCEKF` class with zero observer acceleration in all directions. You must use the `setTrackFilterProperties` function of the trackers to update the `ObserverInput`.

Extended Capabilities

C/C++ Code Generation

Generate C and C++ code using MATLAB® Coder™.

See Also

Functions

`constvelmsc` | `constvelmscjac` | `cvmeasmsc` | `cvmeasmscjac`

Objects

`objectDetection` | `trackingMSCEKF`

Introduced in R2018b

initapekf

Constant velocity angle-parameterized EKF initialization

Syntax

```
filter = initapekf(detection)
filter = initapekf(detection,numFilters)
filter = initapekf(detection,numFilters,angleLimits)
```

Description

`filter = initapekf(detection)` configures the filter with 10 extended Kalman filters (EKFs). The function configures the process noise with unit standard deviation in acceleration.

The angle-parameterized extended Kalman filter (APEKF) is a Gaussian-sum filter (`trackingGSF`) with multiple EKFs, each initialized at an estimated angular position of the target. Angle-parametrization is a commonly used technique to initialize a filter from a range-only detection.

`filter = initapekf(detection,numFilters)` specifies the number of EKFs in the filter.

`filter = initapekf(detection,numFilters,angleLimits)` specifies the limits on angular position of the target.

Examples

Initialize APEKF from Range Only Detection and Visualize Filter

The APEKF is a special type of filter that can be initialized using range-only measurements. When the 'Frame' is set to 'spherical', the detection has [azimuth elevation range range-rate] measurements. Specify the measurement parameters appropriately to define a range-only measurement.

```
measParam = struct('Frame','Spherical','HasAzimuth',false,'HasElevation',false,'HasVelocity',false)
```

The `objectDetection` class defines an interface to the range-only detection measured by the sensor. The `MeasurementParameters` field of `objectDetection` carries information about what the sensor is measuring.

```
detection = objectDetection(0,100,'MeasurementNoise',100,'MeasurementParameters',measParam)
```

```
detection =
  objectDetection with properties:
        Time: 0
      Measurement: 100
    MeasurementNoise: 100
        SensorIndex: 1
      ObjectClassID: 0
    MeasurementParameters: [1x1 struct]
      ObjectAttributes: {}
```

The `initapekf` function uses the range-only detection to initialize the APEKF.

```
apekf = initapekf(detection) %#ok

apekf =
  trackingGSF with properties:

          State: [6x1 double]
    StateCovariance: [6x6 double]

    TrackingFilters: {10x1 cell}
    ModelProbabilities: [10x1 double]

    MeasurementNoise: 100
```

You can also initialize the APEKF with 10 filters and to operate within the angular limits of [-30 30] degrees.

```
angleLimits = [-30 30];
numFilters = 10;
apekf = initapekf(detection, numFilters, angleLimits)

apekf =
  trackingGSF with properties:

          State: [6x1 double]
    StateCovariance: [6x6 double]

    TrackingFilters: {10x1 cell}
    ModelProbabilities: [10x1 double]

    MeasurementNoise: 100
```

You can also specify the `initapekf` function as a `FilterInitializationFcn` to the `trackerGNN` object.

```
funcHandle = @(detection)initapekf(detection,numFilters,angleLimits)

funcHandle = function_handle with value:
  @(detection)initapekf(detection,numFilters,angleLimits)

tracker = trackerGNN('FilterInitializationFcn',funcHandle);
```

Visualize the filter.

```
tp = theaterPlot;
componentPlot = trackPlotter(tp,'DisplayName','Individual sums','MarkerFaceColor','r');
sumPlot = trackPlotter(tp,'DisplayName','Mixed State','MarkerFaceColor','g');

indFilters = apekf.TrackingFilters;
pos = zeros(numFilters,3);
cov = zeros(3,3,numFilters);
for i = 1:numFilters
    pos(i,:) = indFilters{i}.State(1:2:end);
    cov(1:3,1:3,i) = indFilters{i}.StateCovariance(1:2:end,1:2:end);
end
```



```

componentPlot.plotTrack(pos,cov);

mixedPos = apekf.State(1:2:end)';
mixedPosCov = apekf.StateCovariance(1:2:end,1:2:end);
sumPlot.plotTrack(mixedPos,mixedPosCov);

```

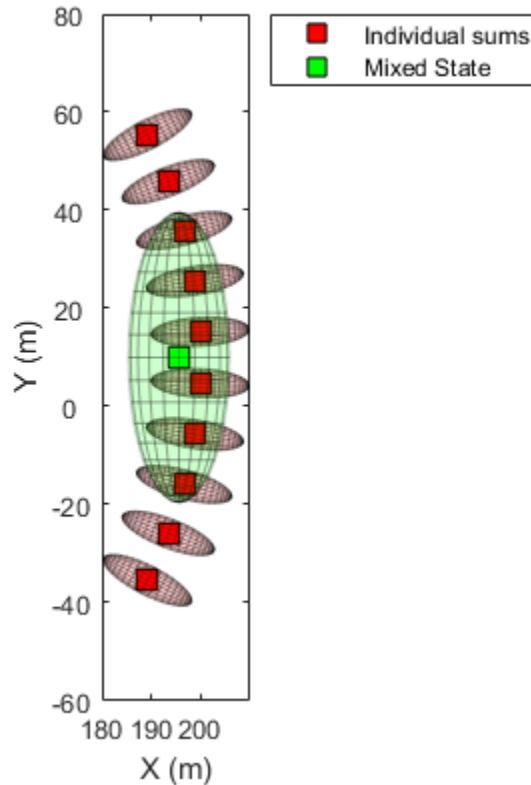

Initialize APEKF from Azimuth and Range Detection and Visualize Filter

Create an angle-parameterized EKF from an [az r] detection.

```
measParam = struct('Frame','Spherical','HasAzimuth',true,'HasElevation',false,'HasVelocity',false);
```

The `objectDetection` class defines an interface to the range-only detection measured by the sensor. The `MeasurementParameters` field of `objectDetection` carries information about what the sensor is measuring.

```
det = objectDetection(0,[30;100],'MeasurementParameters',measParam,'MeasurementNoise',10);
```

The `initapekf` function parameterizes the `apekf` filter on the elevation measurement.

```

numFilters = 10;
apekf = initapekf(det,numFilters,[-30 30]);
indFilters = apekf.TrackingFilters;
pos = zeros(numFilters,3);
cov = zeros(3,3,numFilters);

```

```

for i = 1:numFilters
    pos(i,:) = indFilters{i}.State(1:2:end);
    cov(1:3,1:3,i) = indFilters{i}.StateCovariance(1:2:end,1:2:end);
end

```

Visualize the filter.

```

tp = theaterPlot;
componentPlot = trackPlotter(tp, 'DisplayName', 'Individual sums', 'MarkerFaceColor', 'r');
sumPlot = trackPlotter(tp, 'DisplayName', 'Mixed State', 'MarkerFaceColor', 'g');
componentPlot.plotTrack(pos, cov);
mixedPos = apekf.State(1:2:end)';
mixedPosCov = apekf.StateCovariance(1:2:end,1:2:end);
sumPlot.plotTrack(mixedPos, mixedPosCov);
view(3);

```

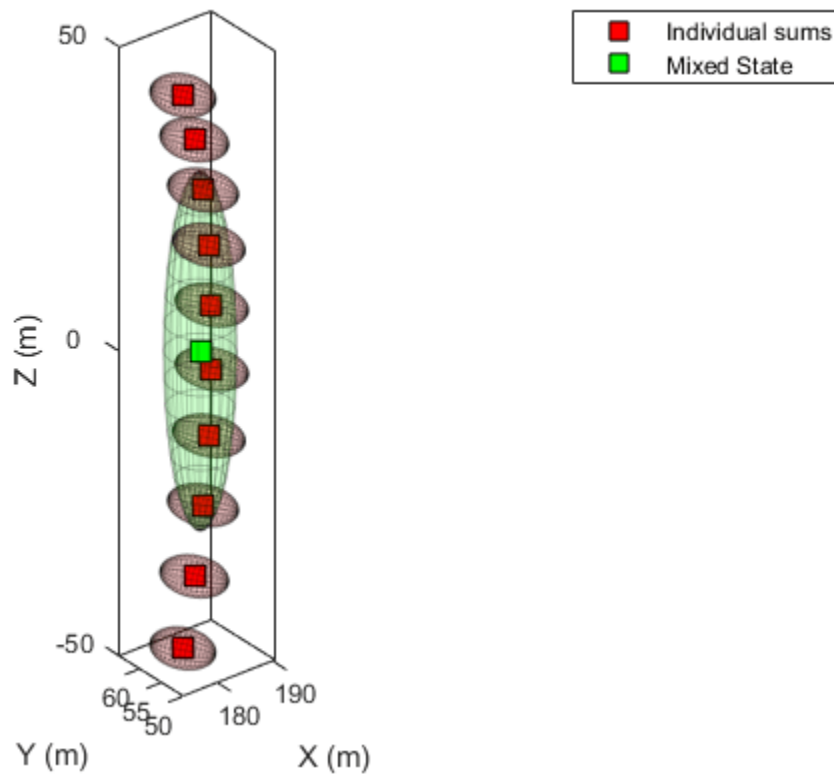

Input Arguments

detection — Detection report

objectDetection object

Detection report, specified as an objectDetection object.

Example: `detection = objectDetection(0,[1;4.5;3], 'MeasurementNoise', [1.0 0 0; 0 2.0 0; 0 0 1.5])`

numFilters — Number of EKFs

10 (default) | positive integer

Number of EKFs each initialized at an estimated angular position of the target, specified as a positive integer. When not specified, the default number of EKFs is 10.

Data Types: `single` | `double` | `int8` | `int16` | `int32` | `int64` | `uint8` | `uint16` | `uint32` | `uint64`

angleLimits — Angular limits of target

two-element vector

Angular limits of the target, specified as a two-element vector. The two elements in the vector represent the lower and upper limits of the target angular position.

When the function detects:

- Range measurements -- Default angular limits are [-180 180].
- Azimuth and range measurements -- Default angular limits are [-90 90].

Data Types: `single` | `double` | `int8` | `int16` | `int32` | `int64` | `uint8` | `uint16` | `uint32` | `uint64`

Output Arguments**filter — Constant velocity angle-parameterized EKF**

trackingGSF object

Constant velocity angle-parameterized extended Kalman filter (EKF), returned as a `trackingGSF` object.

Algorithms

The function can support the following types of measurements in the detection.

- Range measurements -- Parameterization is done on the azimuth of the target, and the angular limits are [-180 180] by default.
- Azimuth and range measurements -- Parameterization is done on the elevation of the target, and the angular limits are [-90 90] by default.

References

- [1] Ristic, Branko, Sanjeev Arulampalam, and James McCarthy. "Target motion analysis using range-only measurements: algorithms, performance and application to ISAR data." *Signal Processing* 82, no. 2 (2002): 273-296.

Extended Capabilities**C/C++ Code Generation**

Generate C and C++ code using MATLAB® Coder™.

See Also

Functions

initcvekf

Objects

objectDetection | trackingEKF | trackingGSF

Introduced in R2018b

initrpekf

Constant velocity range-parameterized EKF initialization

Syntax

```
filter = initrpekf(detection)
filter = initrpekf(detection,numFilters)
filter = initrpekf(detection,numFilters,rangeLimits)
```

Description

`filter = initrpekf(detection)` configures the filter with 6 extended Kalman filters (EKFs), and the target range is assumed to be within $1e3$ and $1e5$ scenario units. The function configures the process noise with unit standard deviation in acceleration.

The range-parameterized extended Kalman filter (RPEKF) is a Gaussian-sum filter (`trackingGSF`) with multiple EKFs, each initialized at an estimated range of the target. Range-parameterization is a commonly used technique to initialize a filter from an angle-only detection.

`filter = initrpekf(detection,numFilters)` specifies the number of EKFs in the filter.

`filter = initrpekf(detection,numFilters,rangeLimits)` specifies the range limits of the target.

Examples

Initialize RPEKF from Angle-only Detection and Visualize Filter

The RPEKF is a special type of filter that can be initialized using angle-only measurements, that is, azimuth and/or elevation. When the 'Frame' is set to 'spherical' and 'HasRange' is set to 'false', the detection has [azimuth elevation] measurements. Specify the measurement parameters appropriately to define an angle-only measurement with no range information.

```
measParam = struct('Frame','spherical','HasRange',false,'OriginPosition',[100;10;0]);
```

The `objectDetection` class defines an interface to the angle-only detection measured by the sensor. The `MeasurementParameters` field of `objectDetection` carries information about what the sensor is measuring.

```
detection = objectDetection(0,[30;30],'MeasurementParameters',measParam,'MeasurementNoise',2*eye
```

The `initrpekf` function uses the angle-only detection to initialize the RPEKF.

```
rpekf = initrpekf(detection) %#ok
```

```
rpekf =
  trackingGSF with properties:
```

```
      State: [6x1 double]
StateCovariance: [6x6 double]
```

```
TrackingFilters: {6x1 cell}
ModelProbabilities: [6x1 double]

MeasurementNoise: [2x2 double]
```

You can also initialize the RPEKF with 10 filters and to operate within the range limits of [1000, 10,000] scenario units.

```
rangeLimits = [1000 10000];
numFilters = 10;
rpekf = initrpekf(detection, numFilters, rangeLimits)

rpekf =
  trackingGSF with properties:
    State: [6x1 double]
    StateCovariance: [6x6 double]
    TrackingFilters: {10x1 cell}
    ModelProbabilities: [10x1 double]
    MeasurementNoise: [2x2 double]
```

You can also specify the `initrpekf` function as a `FilterInitializationFcn` to the `trackerGNN` object.

```
funcHandle = @(detection)initrpekf(detection,numFilters,rangeLimits)

funcHandle = function_handle with value:
  @(detection)initrpekf(detection,numFilters,rangeLimits)

tracker = trackerGNN('FilterInitializationFcn',funcHandle)

tracker =
  trackerGNN with properties:
    TrackerIndex: 0
    FilterInitializationFcn: [function_handle]
      Assignment: 'MatchPairs'
    AssignmentThreshold: [30 Inf]
    MaxNumTracks: 100
    MaxNumSensors: 20
    OOSMHandling: 'Terminate'
    TrackLogic: 'History'
    ConfirmationThreshold: [2 3]
    DeletionThreshold: [5 5]
    HasCostMatrixInput: false
    HasDetectableTrackIDsInput: false
    StateParameters: [1x1 struct]
    NumTracks: 0
```

NumConfirmedTracks: 0

Visualize the filter.

```

tp = theaterPlot;
componentPlot = trackPlotter(tp, 'DisplayName', 'Individual sums', 'MarkerFaceColor', 'r');
sumPlot = trackPlotter(tp, 'DisplayName', 'Mixed State', 'MarkerFaceColor', 'g');

indFilters = rpekf.TrackingFilters;
pos = zeros(numFilters,3);
cov = zeros(3,3,numFilters);
for i = 1:numFilters
    pos(i,:) = indFilters{i}.State(1:2:end);
    cov(1:3,1:3,i) = indFilters{i}.StateCovariance(1:2:end,1:2:end);
end
componentPlot.plotTrack(pos,cov);

mixedPos = rpekf.State(1:2:end)';
mixedPosCov = rpekf.StateCovariance(1:2:end,1:2:end);
sumPlot.plotTrack(mixedPos,mixedPosCov);

```

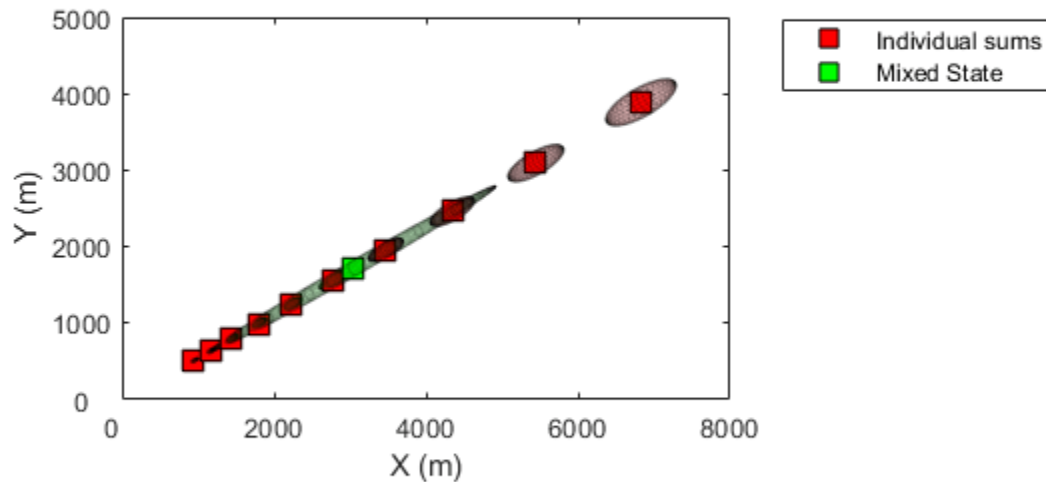

Input Arguments

detection — Detection report
objectDetection object

Detection report, specified as an `objectDetection` object.

Example: `detection = objectDetection(0,[1;4.5;3],'MeasurementNoise',[1.0 0 0; 0 2.0 0; 0 0 1.5])`

numFilters – Number of EKFs

6 (default) | positive integer

Number of EKFs each initialized at an estimated range of the target, specified as a positive integer. When not specified, the default number of EKFs is 6.

Data Types: `single` | `double` | `int8` | `int16` | `int32` | `int64` | `uint8` | `uint16` | `uint32` | `uint64`

rangeLimits – Range limits of target

[1e3 1e5] (default) | two-element vector

Range limits of the target, specified as a two-element vector. The two elements in the vector represent the lower and upper limits of the target range. When not specified, the default range limits are [1e3 1e5] scenario units.

Data Types: `single` | `double` | `int8` | `int16` | `int32` | `int64` | `uint8` | `uint16` | `uint32` | `uint64`

Output Arguments

filter – Constant velocity range-parameterized EKF

`trackingGSF` object

Constant velocity range-parameterized extended Kalman filter (EKF), returned as a `trackingGSF` object.

References

- [1] Peach, N. "Bearings-only tracking using a set of range-parameterised extended Kalman filters." IEE Proceedings-Control Theory and Applications 142, no. 1 (1995): 73-80.

Extended Capabilities

C/C++ Code Generation

Generate C and C++ code using MATLAB® Coder™.

See Also

Functions

`initapekf` | `initcvekf` | `initcvmscekf`

Objects

`objectDetection` | `trackingEKF` | `trackingGSF`

Introduced in R2018b

initekfirm

Initialize trackingIMM object

Syntax

```
imm = initekfirm(detection)
```

Description

`imm = initekfirm(detection)` initializes a constant velocity (CV), constant acceleration (CA), and a constant turn (CT) trackingIMM (`imm`) object based on information provided in an `objectDetection` object, `detection`.

The function initializes a constant velocity state $[x; v_x; y; v_y; z; v_z]$.

Examples

Detection with Position Measurement in Rectangular Frame

A 3-D position measurement in rectangular frame is provided. For example, $x = 1$, $y = 3$, and $z = 0$. Use a 3-D position measurement noise $[1 \ 0.4 \ 0; 0.4 \ 4 \ 0; 0 \ 0 \ 1]$.

```
detection = objectDetection(0, [1;3;0], 'MeasurementNoise', [1 0.4 0; 0.4 4 0; 0 0 1]);
```

Use `initekfirm` to create a trackingIMM filter initialized at the provided position and using the measurement noise defined above.

```
imm = initekfirm(detection);
```

Check the values of the state and measurement noise. Verify that the filter state, `imm.State`, has the same position components as detection measurement, `detection.Measurement`.

```
imm.State
```

```
ans = 6×1
```

```
1
0
3
0
0
0
```

Verify that the filter measurement noise, `imm.MeasurementNoise`, is the same as the `detection.MeasurementNoise` values.

```
imm.MeasurementNoise
```

```
ans = 3×3
```

```
1.0000    0.4000         0
0.4000    4.0000         0
         0         0    1.0000
```

Detection with Position Measurement in Spherical Frame

A 3-D position measurement in spherical frame is provided. For example: $az = 40$, $el = 6$, $r = 100$, $rr = 5$. Measurement noise is `diag([2.5, 2.5, 0.5, 1].^2)`.

```
meas = [40;6;100;5];
measNoise = diag([2.5,2.5,0.5,1].^2);
```

Use the `MeasurementParameters` to define the frame. You can leave out other fields of the `MeasurementParameters` struct, and they will be completed by default values. In this example, sensor position, sensor velocity, orientation, elevation, and range rate flags are default.

```
measParams = struct('Frame','spherical');
detection = objectDetection(0,meas,'MeasurementNoise',measNoise,...
    'MeasurementParameters',measParams);
```

Use `initekfirm` to create a `trackingIMM` filter initialized at the provided position and using the measurement noise defined above.

```
imm = initekfirm(detection)
```

```
imm =
    trackingIMM with properties:

        State: [6x1 double]
        StateCovariance: [6x6 double]

        TrackingFilters: {3x1 cell}
        ModelConversionFcn: @switchimm
        TransitionProbabilities: [3x3 double]

        MeasurementNoise: [4x4 double]
        ModelProbabilities: [3x1 double]

        EnableSmoothing: 0
```

Input Arguments

detection — Detection report

`objectDetection` object

Detection report, specified as an `objectDetection` object.

```
Example: detection = objectDetection(0,[1;4.5;3],'MeasurementNoise',[1.0 0 0;
0 2.0 0; 0 0 1.5])
```

Output Arguments

imm — trackingIMM object

trackingIMM object

Constant velocity (CV), constant acceleration (CA), and a constant turn (CT) trackingIMM (imm) object based on information provided in `detection`, returned as a trackingIMM object.

Extended Capabilities

C/C++ Code Generation

Generate C and C++ code using MATLAB® Coder™.

See Also

Objects

`objectDetection` | `trackingIMM`

Functions

`initcaekf` | `initctekf` | `initcvekf`

Introduced in R2018b

initcaekf

Create constant-acceleration extended Kalman filter from detection report

Syntax

```
filter = initcaekf(detection)
```

Description

`filter = initcaekf(detection)` creates and initializes a constant-acceleration extended Kalman filter from information contained in a `detection` report. For more information about the extended Kalman filter, see `trackingEKF`.

The function initializes a constant acceleration state with the same convention as `constacc` and `cameas`, $[x; v_x; a_x; y; v_y; a_y; z; v_z; a_z]$.

Examples

Initialize 3-D Constant-Acceleration Extended Kalman Filter

Create and initialize a 3-D constant-acceleration extended Kalman filter object from an initial detection report.

Create the detection report from an initial 3-D measurement, $(-200;30;0)$, of the object position. Assume uncorrelated measurement noise.

```
detection = objectDetection(0,[-200;-30;0], 'MeasurementNoise',2.1*eye(3), ...
    'SensorIndex',1, 'ObjectClassID',1, 'ObjectAttributes',{'Car',2});
```

Create the new filter from the detection report and display its properties.

```
filter = initcaekf(detection)

filter =
    trackingEKF with properties:

        State: [9x1 double]
        StateCovariance: [9x9 double]

        StateTransitionFcn: @constacc
        StateTransitionJacobianFcn: @constaccjac
        ProcessNoise: [3x3 double]
        HasAdditiveProcessNoise: 0

        MeasurementFcn: @cameas
        MeasurementJacobianFcn: @cameasjac
        MeasurementNoise: [3x3 double]
        HasAdditiveMeasurementNoise: 1

        EnableSmoothing: 0
```

Show the filter state.

```
filter.State
```

```
ans = 9×1
```

```
-200
  0
  0
 -30
  0
  0
  0
  0
  0
```

Show the state covariance matrix.

```
filter.StateCovariance
```

```
ans = 9×9
```

```
 2.1000    0    0    0    0    0    0    0    0
    0 100.0000    0    0    0    0    0    0    0
    0    0 100.0000    0    0    0    0    0    0
    0    0    0 2.1000    0    0    0    0    0
    0    0    0    0 100.0000    0    0    0    0
    0    0    0    0    0 100.0000    0    0    0
    0    0    0    0    0    0 2.1000    0    0
    0    0    0    0    0    0    0 100.0000    0
    0    0    0    0    0    0    0    0 100.0000
```

Create 3D Constant Acceleration EKF from Spherical Measurement

Initialize a 3D constant-acceleration extended Kalman filter from an initial detection report made from an initial measurement in spherical coordinates. If you want to use spherical coordinates, then you must supply a measurement parameter structure as part of the detection report with the `Frame` field set to `'spherical'`. Set the azimuth angle of the target to 45° , the elevation to 22° , the range to 1000 meters, and the range rate to -4.0 m/s.

```
frame = 'spherical';
sensorpos = [25,-40,-10].';
sensorvel = [0;5;0];
laxes = eye(3);
```

Create the measurement parameters structure. Set `'HasVelocity'` and `'HasElevation'` to true. Then, the measurement vector consists of azimuth, elevation, range, and range rate.

```
measparms = struct('Frame',frame,'OriginPosition',sensorpos, ...
    'OriginVelocity',sensorvel,'Orientation',laxes,'HasVelocity',true, ...
    'HasElevation',true);
meas = [45;22;1000;-4];
measnoise = diag([3.0,2.5,2,1.0].^2);
```

```
detection = objectDetection(0,meas,'MeasurementNoise', ...  
    measnoise,'MeasurementParameters',measparms)
```

```
detection =  
    objectDetection with properties:  
  
        Time: 0  
        Measurement: [4x1 double]  
        MeasurementNoise: [4x4 double]  
        SensorIndex: 1  
        ObjectClassID: 0  
        MeasurementParameters: [1x1 struct]  
        ObjectAttributes: {}
```

```
filter = initcaekf(detection);
```

Display the state vector.

```
disp(filter.State)
```

```
680.6180  
-2.6225  
0  
615.6180  
2.3775  
0  
364.6066  
-1.4984  
0
```

Input Arguments

detection — Detection report

objectDetection object

Detection report, specified as an objectDetection object.

Example: `detection = objectDetection(0,[1;4.5;3],'MeasurementNoise', [1.0 0 0;
0 2.0 0; 0 0 1.5])`

Output Arguments

filter — Extended Kalman filter

trackingEKF object

Extended Kalman filter, returned as a trackingEKF object.

Algorithms

- The function computes the process noise matrix assuming a one-second time step and an acceleration-rate standard deviation of 1 m/s³.
- You can use this function as the FilterInitializationFcn property of a trackerGNN or trackerTOMHT object.

Extended Capabilities

C/C++ Code Generation

Generate C and C++ code using MATLAB® Coder™.

See Also

Functions

[initcakf](#) | [initcaukf](#) | [initctekf](#) | [initctukf](#) | [initcvekf](#) | [initcvkf](#) | [initcvukf](#)

Objects

[objectDetection](#) | [trackerGNN](#) | [trackerTOMHT](#) | [trackingEKF](#) | [trackingKF](#) | [trackingUKF](#)

Introduced in R2018b

initcakf

Create constant-acceleration linear Kalman filter from detection report

Syntax

```
filter = initcakf(detection)
```

Description

`filter = initcakf(detection)` creates and initializes a constant-acceleration linear Kalman filter from information contained in a `detection` report. For more information about the linear Kalman filter, see `trackingKF`.

The function initializes a constant acceleration state with the same convention as `constacc` and `cameas`, $[x; v_x; a_x; y; v_y; a_y; z; v_z; a_z]$.

Examples

Initialize 2-D Constant-Acceleration Linear Kalman Filter

Create and initialize a 2-D constant-acceleration linear Kalman filter object from an initial detection report.

Create the detection report from an initial 2-D measurement, (10,-5), of the object position. Assume uncorrelated measurement noise.

```
detection = objectDetection(0,[10;-5], 'MeasurementNoise', eye(2), ...  
    'SensorIndex', 1, 'ObjectClassID', 1, 'ObjectAttributes', {'Car', 5});
```

Create the new filter from the detection report.

```
filter = initcakf(detection);
```

Show the filter state.

```
filter.State
```

```
ans = 6×1
```

```
    10  
     0  
     0  
    -5  
     0  
     0
```

Show the state transition model.

```
filter.StateTransitionModel
```

ans = 6×6

```

1.0000    1.0000    0.5000         0         0         0
         0    1.0000    1.0000         0         0         0
         0         0    1.0000         0         0         0
         0         0         0    1.0000    1.0000    0.5000
         0         0         0         0    1.0000    1.0000
         0         0         0         0         0    1.0000

```

Input Arguments

detection — Detection report

objectDetection object

Detection report, specified as an `objectDetection` object.

Example: `detection = objectDetection(0,[1;4.5;3],'MeasurementNoise',[1.0 0 0; 0 2.0 0; 0 0 1.5])`

Output Arguments

filter — Linear Kalman filter

trackingKF object

Linear Kalman filter, returned as a `trackingKF` object.

Algorithms

- The function computes the process noise matrix assuming a one-second time step and an acceleration rate standard deviation of 1 m/s³.
- You can use this function as the `FilterInitializationFcn` property of a `trackerGNN` or `trackerTOMHT` object.

Extended Capabilities

C/C++ Code Generation

Generate C and C++ code using MATLAB® Coder™.

See Also

Functions

`initcaekf` | `initcaukf` | `initctekf` | `initctukf` | `initcvekf` | `initcvkf` | `initcvukf`

Objects

`objectDetection` | `trackerGNN` | `trackerTOMHT` | `trackingEKF` | `trackingKF` | `trackingUKF`

Introduced in R2018b

initcaukf

Create constant-acceleration unscented Kalman filter from detection report

Syntax

```
filter = initcaukf(detection)
```

Description

`filter = initcaukf(detection)` creates and initializes a constant-acceleration unscented Kalman filter from information contained in a `detection` report. For more information about the unscented Kalman filter, see `trackingUKF`.

The function initializes a constant acceleration state with the same convention as `constacc` and `cameas`, $[x; v_x; a_x; y; v_y; a_y; z; v_z; a_z]$.

Examples

Initialize 3-D Constant-Acceleration Unscented Kalman Filter

Create and initialize a 3-D constant-acceleration unscented Kalman filter object from an initial detection report.

Create the detection report from an initial 3-D measurement, (-200,-30,5), of the object position. Assume uncorrelated measurement noise.

```
detection = objectDetection(0,[-200;-30;5], 'MeasurementNoise', 2.0*eye(3), ...
    'SensorIndex', 1, 'ObjectClassID', 1, 'ObjectAttributes', {'Car', 2});
```

Create the new filter from the detection report and display the filter properties.

```
filter = initcaukf(detection)

filter =
    trackingUKF with properties:

        State: [9x1 double]
        StateCovariance: [9x9 double]

        StateTransitionFcn: @constacc
        ProcessNoise: [3x3 double]
        HasAdditiveProcessNoise: 0

        MeasurementFcn: @cameas
        MeasurementNoise: [3x3 double]
        HasAdditiveMeasurementNoise: 1

        Alpha: 1.0000e-03
        Beta: 2
        Kappa: 0
```

```
EnableSmoothing: 0
```

Show the state.

```
filter.State
```

```
ans = 9×1
```

```
-200
  0
  0
-30
  0
  0
  5
  0
  0
```

Show the state covariance matrix.

```
filter.StateCovariance
```

```
ans = 9×9
```

```
  2.0000    0    0    0    0    0    0    0    0
    0 100.0000    0    0    0    0    0    0    0
    0    0 100.0000    0    0    0    0    0    0
    0    0    0  2.0000    0    0    0    0    0
    0    0    0    0 100.0000    0    0    0    0
    0    0    0    0    0 100.0000    0    0    0
    0    0    0    0    0    0  2.0000    0    0
    0    0    0    0    0    0    0 100.0000    0
    0    0    0    0    0    0    0    0 100.0000
```

Create 3D Constant Acceleration UKF from Spherical Measurement

Initialize a 3D constant-acceleration unscented Kalman filter from an initial detection report made from a measurement in spherical coordinates. If you want to use spherical coordinates, then you must supply a measurement parameter structure as part of the detection report with the `Frame` field set to `'spherical'`. Set the azimuth angle of the target to 45° , and the range to 1000 meters.

```
frame = 'spherical';
sensorpos = [25,-40,-10].';
sensorvel = [0;5;0];
laxes = eye(3);
```

Create the measurement structure. Set `'HasVelocity'` and `'HasElevation'` to false. Then, the measurement vector consists of azimuth angle and range.

```
measparms = struct('Frame',frame,'OriginPosition',sensorpos, ...
    'OriginVelocity',sensorvel,'Orientation',laxes,'HasVelocity',false, ...
    'HasElevation',false);
```

```
meas = [45;1000];  
measnoise = diag([3.0,2.0].^2);  
detection = objectDetection(0,meas,'MeasurementNoise', ...  
    measnoise,'MeasurementParameters',measparms)
```

```
detection =  
    objectDetection with properties:  
  
        Time: 0  
    Measurement: [2x1 double]  
    MeasurementNoise: [2x2 double]  
    SensorIndex: 1  
    ObjectClassID: 0  
    MeasurementParameters: [1x1 struct]  
    ObjectAttributes: {}
```

```
filter = initcaukf(detection);
```

Display the state vector.

```
disp(filter.State)
```

```
732.1068  
    0  
    0  
667.1068  
    0  
    0  
-10.0000  
    0  
    0
```

Input Arguments

detection — Detection report

objectDetection object

Detection report, specified as an objectDetection object.

Example: `detection = objectDetection(0,[1;4.5;3],'MeasurementNoise', [1.0 0 0;
0 2.0 0; 0 0 1.5])`

Output Arguments

filter — Unscented Kalman filter

trackingUKF object

Unscented Kalman filter, returned as a trackingUKF object.

Algorithms

- The function computes the process noise matrix assuming a one-second time step and an acceleration rate standard deviation of 1 m/s³.

- You can use this function as the `FilterInitializationFcn` property of a `trackerGNN` or `trackerTOMHT` object.

Extended Capabilities

C/C++ Code Generation

Generate C and C++ code using MATLAB® Coder™.

See Also

Functions

`initcaekf` | `initcakf` | `initctekf` | `initctukf` | `initcvekf` | `initcvkf` | `initcvukf`

Objects

`objectDetection` | `trackerGNN` | `trackerTOMHT` | `trackingEKF` | `trackingKF` | `trackingUKF`

Introduced in R2018b

initctekf

Create constant turn-rate extended Kalman filter from detection report

Syntax

```
filter = initctekf(detection)
```

Description

`filter = initctekf(detection)` creates and initializes a constant-turn-rate extended Kalman filter from information contained in a `detection` report. For more information about the extended Kalman filter, see `trackingEKF`.

The function initializes a constant turn-rate state with the same convention as `constturn` and `ctmeas`, $[x; v_x; y; v_y; \omega; z; v_z]$, where ω is the turn-rate.

Examples

Initialize 2-D Constant Turn-Rate Extended Kalman Filter

Create and initialize a 2-D constant turn-rate extended Kalman filter object from an initial detection report.

Create the detection report from an initial 2-D measurement, (-250,-40), of the object position. Assume uncorrelated measurement noise.

Extend the measurement to three dimensions by adding a z-component of zero.

```
detection = objectDetection(0, [-250; -40; 0], 'MeasurementNoise', 2.0*eye(3), ...
    'SensorIndex', 1, 'ObjectClassID', 1, 'ObjectAttributes', {'Car', 2});
```

Create the new filter from the detection report and display the filter properties.

```
filter = initctekf(detection)

filter =
    trackingEKF with properties:

        State: [7x1 double]
        StateCovariance: [7x7 double]

        StateTransitionFcn: @constturn
        StateTransitionJacobianFcn: @constturnjac
        ProcessNoise: [4x4 double]
        HasAdditiveProcessNoise: 0

        MeasurementFcn: @ctmeas
        MeasurementJacobianFcn: @ctmeasjac
        MeasurementNoise: [3x3 double]
        HasAdditiveMeasurementNoise: 1
```

```
EnableSmoothing: 0
```

Show the state.

```
filter.State
```

```
ans = 7×1
```

```
-250
  0
 -40
  0
  0
  0
  0
```

Show the state covariance matrix.

```
filter.StateCovariance
```

```
ans = 7×7
```

```
 2.0000    0    0    0    0    0    0
  0 100.0000    0    0    0    0    0
  0    0  2.0000    0    0    0    0
  0    0    0 100.0000    0    0    0
  0    0    0    0 100.0000    0    0
  0    0    0    0    0  2.0000    0
  0    0    0    0    0    0 100.0000
```

Create 2-D Constant Turnrate EKF from Spherical Measurement

Initialize a 2-D constant-turnrate extended Kalman filter from an initial detection report made from an initial measurement in spherical coordinates. If you want to use spherical coordinates, then you must supply a measurement parameter structure as part of the detection report with the `Frame` field set to `'spherical'`. Set the azimuth angle of the target to 45 degrees, the range to 1000 meters, and the range rate to -4.0 m/s.

```
frame = 'spherical';
sensorpos = [25,-40,-10].';
sensorvel = [0;5;0];
laxes = eye(3);
```

Create the measurement parameters structure. Set `'HasElevation'` to `false`. Then, the measurement consists of azimuth, range, and range rate.

```
measparms = struct('Frame',frame,'OriginPosition',sensorpos, ...
    'OriginVelocity',sensorvel,'Orientation',laxes,'HasVelocity',true, ...
    'HasElevation',false);
meas = [45;1000;-4];
measnoise = diag([3.0,2,1.0].^2);
detection = objectDetection(0,meas,'MeasurementNoise', ...
    measnoise,'MeasurementParameters',measparms)
```

```
detection =  
  objectDetection with properties:  
      Time: 0  
      Measurement: [3x1 double]  
      MeasurementNoise: [3x3 double]  
      SensorIndex: 1  
      ObjectClassID: 0  
      MeasurementParameters: [1x1 struct]  
      ObjectAttributes: {}
```

```
filter = initctekf(detection);
```

Filter state vector.

```
disp(filter.State)
```

```
732.1068  
-2.8284  
667.1068  
2.1716  
0  
-10.0000  
0
```

Input Arguments

detection — Detection report

objectDetection object

Detection report, specified as an objectDetection object.

Example: `detection = objectDetection(0,[1;4.5;3],'MeasurementNoise', [1.0 0 0;
0 2.0 0; 0 0 1.5])`

Output Arguments

filter — Extended Kalman filter

trackingEKF object

Extended Kalman filter, returned as a trackingEKF object.

Algorithms

- The function computes the process noise matrix assuming a one-second time step. The function assumes an acceleration standard deviation of 1 m/s², and a turn-rate acceleration standard deviation of 1°/s².
- You can use this function as the FilterInitializationFcn property of a trackerGNN or trackerTOMHT object.

Extended Capabilities

C/C++ Code Generation

Generate C and C++ code using MATLAB® Coder™.

See Also

Functions

[initcaekf](#) | [initcakf](#) | [initcaukf](#) | [initctukf](#) | [initcvekf](#) | [initcvkf](#) | [initcvukf](#)

Objects

[objectDetection](#) | [trackerGNN](#) | [trackerTOMHT](#) | [trackingEKF](#) | [trackingKF](#) | [trackingUKF](#)

Introduced in R2018b

initctukf

Create constant turn-rate unscented Kalman filter from detection report

Syntax

```
filter = initctukf(detection)
```

Description

`filter = initctukf(detection)` creates and initializes a constant-turn-rate unscented Kalman filter from information contained in a `detection` report. For more information about the unscented Kalman filter, see `trackingUKF`.

The function initializes a constant turn-rate state with the same convention as `constturn` and `ctmeas`, $[x; v_x; y; v_y; \omega; z; v_z]$, where ω is the turn-rate.

Examples

Initialize 2-D Constant Turn-Rate Unscented Kalman Filter

Create and initialize a 2-D constant turn-rate unscented Kalman filter object from an initial detection report.

Create the detection report from an initial 2D measurement, (-250,-40), of the object position. Assume uncorrelated measurement noise.

Extend the measurement to three dimensions by adding a z-component of zero.

```
detection = objectDetection(0,[-250;-40;0], 'MeasurementNoise',2.0*eye(3), ...
    'SensorIndex',1, 'ObjectClassID',1, 'ObjectAttributes',{'Car',2});
```

Create the new filter from the detection report and display the filter properties.

```
filter = initctukf(detection)

filter =
    trackingUKF with properties:

        State: [7x1 double]
        StateCovariance: [7x7 double]

        StateTransitionFcn: @constturn
        ProcessNoise: [4x4 double]
        HasAdditiveProcessNoise: 0

        MeasurementFcn: @ctmeas
        MeasurementNoise: [3x3 double]
        HasAdditiveMeasurementNoise: 1

        Alpha: 1.0000e-03
        Beta: 2
```

Kappa: 0

EnableSmoothing: 0

Show the filter state.

filter.State

ans = 7×1

```
-250
  0
 -40
  0
  0
  0
  0
```

Show the state covariance matrix.

filter.StateCovariance

ans = 7×7

```
 2.0000    0    0    0    0    0    0
    0 100.0000    0    0    0    0    0
    0    0  2.0000    0    0    0    0
    0    0    0 100.0000    0    0    0
    0    0    0    0 100.0000    0    0
    0    0    0    0    0  2.0000    0
    0    0    0    0    0    0 100.0000
```

Create 2-D Constant Turn-rate UKF from Spherical Measurement

Initialize a 2-D constant turn-rate extended Kalman filter from an initial detection report made from an initial measurement in spherical coordinates. If you want to use spherical coordinates, then you must supply a measurement parameter structure as part of the detection report with the `Frame` field set to `'spherical'`. Set the azimuth angle of the target to 45 degrees and the range to 1000 meters.

```
frame = 'spherical';
sensorpos = [25,-40,-10].';
sensorvel = [0;5;0];
laxes = eye(3);
```

Create the measurement parameters structure. Set `'HasVelocity'` and `'HasElevation'` to `false`. Then, the measurement consists of azimuth and range.

```
measparms = struct('Frame',frame,'OriginPosition',sensorpos, ...
    'OriginVelocity',sensorvel,'Orientation',laxes,'HasVelocity',false, ...
    'HasElevation',false);
meas = [45;1000];
measnoise = diag([3.0,2].^2);
```

```
detection = objectDetection(0,meas,'MeasurementNoise', ...  
    measnoise,'MeasurementParameters',measparms)
```

```
detection =  
    objectDetection with properties:  
  
        Time: 0  
        Measurement: [2x1 double]  
        MeasurementNoise: [2x2 double]  
        SensorIndex: 1  
        ObjectClassID: 0  
        MeasurementParameters: [1x1 struct]  
        ObjectAttributes: {}
```

```
filter = initctukf(detection);
```

Filter state vector.

```
disp(filter.State)
```

```
732.1068  
    0  
667.1068  
    0  
    0  
-10.0000  
    0
```

Input Arguments

detection – Detection report

objectDetection object

Detection report, specified as an objectDetection object.

Example: `detection = objectDetection(0,[1;4.5;3],'MeasurementNoise', [1.0 0 0;
0 2.0 0; 0 0 1.5])`

Output Arguments

filter – Unscented Kalman filter

trackingUKF object

Unscented Kalman filter, returned as a trackingUKF object.

Algorithms

- The function computes the process noise matrix assuming a one-second time step. The function assumes an acceleration standard deviation of 1 m/s², and a turn-rate acceleration standard deviation of 1°/s².
- You can use this function as the FilterInitializationFcn property of a trackerGNN or trackerTOMHT object.

Extended Capabilities

C/C++ Code Generation

Generate C and C++ code using MATLAB® Coder™.

See Also

Functions

[initcaekf](#) | [initcakf](#) | [initcaukf](#) | [initcvekf](#) | [initcvkf](#) | [initcvukf](#)

Objects

[objectDetection](#) | [trackerGNN](#) | [trackerTOMHT](#) | [trackingEKF](#) | [trackingKF](#) | [trackingUKF](#)

Introduced in R2018b

initcvekf

Create constant-velocity extended Kalman filter from detection report

Syntax

```
filter = initcvekf(detection)
```

Description

`filter = initcvekf(detection)` creates and initializes a constant-velocity extended Kalman filter from information contained in a `detection` report. For more information about the extended Kalman filter, see `trackingEKF`.

The function initializes a constant velocity state with the same convention as `constvel` and `cvmeas`, $[x; v_x; y; v_y; z; v_z]$.

Examples

Initialize 3-D Constant-Velocity Extended Kalman Filter

Create and initialize a 3-D constant-velocity extended Kalman filter object from an initial detection report.

Create the detection report from an initial 3-D measurement, (10,20,-5), of the object position.

```
detection = objectDetection(0,[10;20;-5], 'MeasurementNoise',1.5*eye(3), ...  
    'SensorIndex',1, 'ObjectClassID',1, 'ObjectAttributes',{'Sports Car',5});
```

Create the new filter from the detection report.

```
filter = initcvekf(detection)
```

```
filter =  
    trackingEKF with properties:  
  
        State: [6x1 double]  
        StateCovariance: [6x6 double]  
  
        StateTransitionFcn: @constvel  
        StateTransitionJacobianFcn: @constveljac  
        ProcessNoise: [3x3 double]  
        HasAdditiveProcessNoise: 0  
  
        MeasurementFcn: @cvmeas  
        MeasurementJacobianFcn: @cvmeasjac  
        MeasurementNoise: [3x3 double]  
        HasAdditiveMeasurementNoise: 1  
  
        EnableSmoothing: 0
```

Show the filter state.

```
filter.State
```

```
ans = 6×1
```

```
10
 0
20
 0
-5
 0
```

Show the state covariance.

```
filter.StateCovariance
```

```
ans = 6×6
```

```
1.5000    0    0    0    0    0
 0 100.0000    0    0    0    0
 0    0 1.5000    0    0    0
 0    0    0 100.0000    0    0
 0    0    0    0 1.5000    0
 0    0    0    0    0 100.0000
```

Create 3-D Constant Velocity EKF from Spherical Measurement

Initialize a 3-D constant-velocity extended Kalman filter from an initial detection report made from a 3-D measurement in spherical coordinates. If you want to use spherical coordinates, then you must supply a measurement parameter structure as part of the detection report with the `Frame` field set to `'spherical'`. Set the azimuth angle of the target to 45 degrees, the elevation to -10 degrees, the range to 1000 meters, and the range rate to -4.0 m/s.

```
frame = 'spherical';
sensorpos = [25,-40,0].';
sensorvel = [0;5;0];
laxes = eye(3);
measparms = struct('Frame',frame,'OriginPosition',sensorpos, ...
    'OriginVelocity',sensorvel,'Orientation',laxes,'HasVelocity',true, ...
    'HasElevation',true);
meas = [45;-10;1000;-4];
measnoise = diag([3.0,2.5,2,1.0].^2);
detection = objectDetection(0,meas,'MeasurementNoise', ...
    measnoise,'MeasurementParameters',measparms)
```

```
detection =
    objectDetection with properties:
```

```
Time: 0
Measurement: [4x1 double]
MeasurementNoise: [4x4 double]
SensorIndex: 1
ObjectClassID: 0
```

```
MeasurementParameters: [1x1 struct]
ObjectAttributes: {}
```

```
filter = initcvkf(detection);
```

Filter state vector.

```
disp(filter.State)
```

```
721.3642
-2.7855
656.3642
2.2145
-173.6482
0.6946
```

Input Arguments

detection — Detection report

objectDetection object

Detection report, specified as an objectDetection object.

Example: `detection = objectDetection(0,[1;4.5;3],'MeasurementNoise',[1.0 0 0; 0 2.0 0; 0 0 1.5])`

Output Arguments

filter — Extended Kalman filter

trackingEKF object

Extended Kalman filter, returned as a trackingEKF object.

Algorithms

- The function computes the process noise matrix assuming a one-second time step and an acceleration standard deviation of 1 m/s².
- You can use this function as the `FilterInitializationFcn` property of a `trackerGNN` or `trackerTOMHT` object.

Extended Capabilities

C/C++ Code Generation

Generate C and C++ code using MATLAB® Coder™.

See Also

Functions

`initcaekf` | `initcakf` | `initcaukf` | `initctekf` | `initctukf` | `initcvkf` | `initcvukf`

Objects

`objectDetection` | `trackerGNN` | `trackerTOMHT` | `trackingEKF` | `trackingKF` | `trackingUKF`

Introduced in R2018b

initcvkf

Create constant-velocity linear Kalman filter from detection report

Syntax

```
filter = initcvkf(detection)
```

Description

`filter = initcvkf(detection)` creates and initializes a constant-velocity linear Kalman filter from information contained in a detection report. For more information about the linear Kalman filter, see `trackingKF`.

The function initializes a constant velocity state with the same convention as `constvel` and `cvmeas`, $[x; v_x; y; v_y; z; v_z]$.

Examples

Initialize 2-D Constant-Velocity Linear Kalman Filter

Create and initialize a 2-D linear Kalman filter object from an initial detection report.

Create the detection report from an initial 2-D measurement, (10,20), of the object position.

```
detection = objectDetection(0,[10;20], 'MeasurementNoise',[1 0.2; 0.2 2], ...  
    'SensorIndex',1, 'ObjectClassID',1, 'ObjectAttributes',{ 'Yellow Car',5});
```

Create the new track from the detection report.

```
filter = initcvkf(detection)
```

```
filter =
```

```
trackingKF with properties:
```

```
    State: [4x1 double]  
StateCovariance: [4x4 double]  
  
    MotionModel: '2D Constant Velocity'  
    ControlModel: []  
    ProcessNoise: [4x4 double]  
  
    MeasurementModel: [2x4 double]  
    MeasurementNoise: [2x2 double]  
  
    EnableSmoothing: 0
```

Show the state.

```
filter.State
```

```
ans = 4×1
```

```
10
 0
20
 0
```

Show the state transition model.

```
filter.StateTransitionModel
```

```
ans = 4×4
```

```
 1    1    0    0
 0    1    0    0
 0    0    1    1
 0    0    0    1
```

Initialize 3-D Constant-Velocity Linear Kalman Filter

Create and initialize a 3-D linear Kalman filter object from an initial detection report.

Create the detection report from an initial 3-D measurement, (10,20,-5), of the object position.

```
detection = objectDetection(0,[10;20;-5], 'MeasurementNoise',eye(3), ...
    'SensorIndex', 1, 'ObjectClassID',1, 'ObjectAttributes', {'Green Car', 5});
```

Create the new filter from the detection report and display its properties.

```
filter = initcvkf(detection)
```

```
filter =
  trackingKF with properties:
    State: [6×1 double]
    StateCovariance: [6×6 double]
    MotionModel: '3D Constant Velocity'
    ControlModel: []
    ProcessNoise: [6×6 double]
    MeasurementModel: [3×6 double]
    MeasurementNoise: [3×3 double]
    EnableSmoothing: 0
```

Show the state.

```
filter.State
```

```
ans = 6×1
```

```
10
```

```
0
20
0
-5
0
```

Show the state transition model.

```
filter.StateTransitionModel
```

```
ans = 6×6
```

```
1    1    0    0    0    0
0    1    0    0    0    0
0    0    1    1    0    0
0    0    0    1    0    0
0    0    0    0    1    1
0    0    0    0    0    1
```

Input Arguments

detection — Detection report

objectDetection object

Detection report, specified as an objectDetection object.

Example: `detection = objectDetection(0,[1;4.5;3],'MeasurementNoise',[1.0 0 0;0 2.0 0;0 0 1.5])`

Output Arguments

filter — Linear Kalman filter

trackingKF object

Linear Kalman filter, returned as a trackingKF object.

Algorithms

- The function computes the process noise matrix assuming a one-second time step and an acceleration standard deviation of 1 m/s².
- You can use this function as the `FilterInitializationFcn` property of a `trackerGNN` or `trackerTOMHT` object.

Extended Capabilities

C/C++ Code Generation

Generate C and C++ code using MATLAB® Coder™.

See Also

Functions

[initcaekf](#) | [initcakf](#) | [initcaukf](#) | [initctekf](#) | [initctukf](#) | [initcvekf](#) | [initcvukf](#)

Objects

[objectDetection](#) | [trackerGNN](#) | [trackerTOMHT](#) | [trackingEKF](#) | [trackingKF](#) | [trackingUKF](#)

Introduced in R2018b

initcvukf

Create constant-velocity unscented Kalman filter from detection report

Syntax

```
filter = initcvukf(detection)
```

Description

`filter = initcvukf(detection)` creates and initializes a constant-velocity unscented Kalman filter from information contained in a `detection` report. For more information about the unscented Kalman filter, see `trackingUKF`.

The function initializes a constant velocity state with the same convention as `constvel` and `cvmeas`, $[x; v_x; y; v_y; z; v_z]$.

Examples

Initialize 3-D Constant-Velocity Unscented Kalman Filter

Create and initialize a 3-D constant-velocity unscented Kalman filter object from an initial detection report.

Create the detection report from an initial 3-D measurement, (10,200,-5), of the object position.

```
detection = objectDetection(0,[10;200;-5],'MeasurementNoise',1.5*eye(3), ...
    'SensorIndex',1,'ObjectClassID',1,'ObjectAttributes',{'Sports Car',5});
```

Create the new filter from the detection report and display the filter properties.

```
filter = initcvukf(detection)

filter =
    trackingUKF with properties:

        State: [6x1 double]
        StateCovariance: [6x6 double]

        StateTransitionFcn: @constvel
        ProcessNoise: [3x3 double]
        HasAdditiveProcessNoise: 0

        MeasurementFcn: @cvmeas
        MeasurementNoise: [3x3 double]
        HasAdditiveMeasurementNoise: 1

        Alpha: 1.0000e-03
        Beta: 2
        Kappa: 0
```

```
EnableSmoothing: 0
```

Display the state.

```
filter.State
```

```
ans = 6×1
```

```
10
 0
200
 0
 -5
 0
```

Show the state covariance.

```
filter.StateCovariance
```

```
ans = 6×6
```

```
1.5000    0    0    0    0    0
 0 100.0000    0    0    0    0
 0    0 1.5000    0    0    0
 0    0    0 100.0000    0    0
 0    0    0    0 1.5000    0
 0    0    0    0    0 100.0000
```

Create Constant Velocity UKF from Spherical Measurement

Initialize a constant-velocity unscented Kalman filter from an initial detection report made from an initial measurement in spherical coordinates. Because the object lies in the x-y plane, no elevation measurement is made. If you want to use spherical coordinates, then you must supply a measurement parameter structure as part of the detection report with the `Frame` field set to `'spherical'`. Set the azimuth angle of the target to 45 degrees, the range to 1000 meters, and the range rate to -4.0 m/s.

```
frame = 'spherical';
sensorpos = [25,-40,0].';
sensorvel = [0;5;0];
laxes = eye(3);
```

Create the measurement parameters structure. Set `'HasElevation'` to `false`. Then, the measurement consists of azimuth, range, and range rate.

```
measparms = struct('Frame',frame,'OriginPosition',sensorpos, ...
    'OriginVelocity',sensorvel,'Orientation',laxes,'HasVelocity',true, ...
    'HasElevation',false);
meas = [45;1000;-4];
measnoise = diag([3.0,2,1.0].^2);
detection = objectDetection(0,meas,'MeasurementNoise', ...
    measnoise,'MeasurementParameters',measparms)
```

```
detection =
    objectDetection with properties:
```

```
        Time: 0
        Measurement: [3x1 double]
MeasurementNoise: [3x3 double]
        SensorIndex: 1
        ObjectClassID: 0
MeasurementParameters: [1x1 struct]
        ObjectAttributes: {}
```

```
filter = initcvukf(detection);
```

Display filter state vector.

```
disp(filter.State)
```

```
732.1068
-2.8284
667.1068
 2.1716
      0
      0
```

Input Arguments

detection – Detection report

`objectDetection` object

Detection report, specified as an `objectDetection` object.

Example: `detection = objectDetection(0,[1;4.5;3], 'MeasurementNoise', [1.0 0 0; 0 2.0 0; 0 0 1.5])`

Output Arguments

filter – Unscented Kalman filter

`trackingUKF` object

Unscented Kalman filter, returned as a `trackingUKF` object.

Algorithms

- The function computes the process noise matrix assuming a one-second time step and an acceleration standard deviation of 1 m/s².
- You can use this function as the `FilterInitializationFcn` property of a `trackerGNN` or `trackerTOMHT` object.

Extended Capabilities

C/C++ Code Generation

Generate C and C++ code using MATLAB® Coder™.

See Also

Functions

[initcaekf](#) | [initcakf](#) | [initcaukf](#) | [initctekf](#) | [initctukf](#) | [initcvekf](#) | [initcvkf](#)

Objects

[objectDetection](#) | [trackerGNN](#) | [trackerTOMHT](#) | [trackingEKF](#) | [trackingKF](#) | [trackingUKF](#)

Introduced in R2018b

clone

Create duplicate tracking filter

Syntax

```
filterClone = clone(filter)
```

Description

`filterClone = clone(filter)` creates a copy of a tracking filter that has the same property values as the original filter.

Input Arguments

filter — Filter for object tracking

`trackingKF` object | `trackingEKF` object | `trackingUKF` object | `trackingABF` object | `trackingCKF` object | `trackingIMM` object | `trackingGSF` object | `trackingPF` object | `trackingMSCEKF` object

Filter for object tracking, specified as one of these objects:

- `trackingKF` — Linear Kalman filter
- `trackingEKF` — Extended Kalman filter
- `trackingUKF` — Unscented Kalman filter
- `trackingABF` — Alpha-beta filter
- `trackingCKF` — Cubature Kalman filter
- `trackingIMM` — Interacting multiple model (IMM) filter
- `trackingGSF` — Gaussian-sum filter
- `trackingPF` — Particle filter
- `trackingMSCEKF` — Extended Kalman filter using modified spherical coordinates (MSC)

Output Arguments

filterClone — Cloned filter

`tracking` filter object

Cloned filter, returned as a tracking filter object of the same type as `filter`. The cloned filter has the same properties as the original filter.

Extended Capabilities

C/C++ Code Generation

Generate C and C++ code using MATLAB® Coder™.

See Also

[correct](#) | [correctjpda](#) | [distance](#) | [initialize](#) | [likelihood](#) | [predict](#) | [residual](#)

Introduced in R2018b

correct

Correct state and state estimation error covariance using tracking filter

Syntax

```
[xcorr,Pcorr] = correct(filter,zmeas)
[xcorr,Pcorr] = correct(filter,zmeas,measparams)
[xcorr,Pcorr] = correct(filter,zmeas,zcov)
[xcorr,Pcorr,zcorr] = correct(filter,zmeas)
[xcorr,Pcorr,zcorr] = correct(filter,zmeas,zcov)

correct(filter, ___)
xcorr = correct(filter, ___)
```

Description

`[xcorr,Pcorr] = correct(filter,zmeas)` returns the corrected state, `xcorr`, and the corrected state estimation error covariance, `Pcorr`, for the next time step of the input tracking filter based on the current measurement, `zmeas`. The corrected values overwrite the internal state and state estimation error covariance of `filter`.

`[xcorr,Pcorr] = correct(filter,zmeas,measparams)` specifies additional parameters used by the measurement function that is defined in the `MeasurementFcn` property of `filter`. You can return any of the outputs from preceding syntaxes.

If `filter` is a `trackingKF` or `trackingABF` object, then you cannot use this syntax.

`[xcorr,Pcorr] = correct(filter,zmeas,zcov)` specifies additional measurement covariance, `zcov`, used in the `MeasurementNoise` property of `filter`.

You can use this syntax only when `filter` is a `trackingKF` object.

`[xcorr,Pcorr,zcorr] = correct(filter,zmeas)` also returns the correction of measurements, `zcorr`.

You can use this syntax only when `filter` is a `trackingABF` object.

`[xcorr,Pcorr,zcorr] = correct(filter,zmeas,zcov)` returns the correction of measurements, `zcorr`, and also specifies additional measurement covariance, `zcov`, used in the `MeasurementNoise` property of `filter`.

You can use this syntax only when `filter` is a `trackingABF` object.

`correct(filter, ___)` updates `filter` with the corrected state and state estimation error covariance without returning the corrected values. Specify the tracking filter and any of the input argument combinations from preceding syntaxes.

`xcorr = correct(filter, ___)` updates `filter` with the corrected state and state estimation error covariance but returns only the corrected state, `xcorr`.

Examples

Constant-Velocity Extended Kalman Filter

Create a two-dimensional `trackingEKF` object and use name-value pairs to define the `StateTransitionJacobianFcn` and `MeasurementJacobianFcn` properties. Use the predefined constant-velocity motion and measurement models and their Jacobians.

```
EKF = trackingEKF(@constvel,@cvmeas,[0;0;0;0], ...
    'StateTransitionJacobianFcn',@constveljac, ...
    'MeasurementJacobianFcn',@cvmeasjac);
```

Run the filter. Use the `predict` and `correct` functions to propagate the state. You may call `predict` and `correct` in any order and as many times you want. Specify the measurement in Cartesian coordinates.

```
measurement = [1;1;0];
[xpred, Ppred] = predict(EKF);
[xcorr, Pcorr] = correct(EKF,measurement);
[xpred, Ppred] = predict(EKF);
[xpred, Ppred] = predict(EKF);
```

`xpred = 4×1`

```
1.2500
0.2500
1.2500
0.2500
```

`Ppred = 4×4`

```
11.7500    4.7500         0         0
 4.7500    3.7500         0         0
         0         0    11.7500    4.7500
         0         0    4.7500    3.7500
```

Input Arguments

filter — Filter for object tracking

`trackingKF` object | `trackingEKF` object | `trackingUKF` object | `trackingABF` object | `trackingCKF` object | `trackingIMM` object | `trackingGSF` object | `trackingPF` object | `trackingMSCEKF` object

Filter for object tracking, specified as one of these objects:

- `trackingKF` — Linear Kalman filter
- `trackingEKF` — Extended Kalman filter
- `trackingUKF` — Unscented Kalman filter
- `trackingABF` — Alpha-beta filter
- `trackingCKF` — Cubature Kalman filter

- `trackingIMM` — Interacting multiple model (IMM) filter
- `trackingGSF` — Gaussian-sum filter
- `trackingPF` — Particle filter
- `trackingMSCEKF` — Extended Kalman filter using modified spherical coordinates (MSC)

zmeas — Measurement of filter

vector | matrix

Measurement of the tracked object, specified as a vector or matrix.

Data Types: `single` | `double`

measparams — Measurement parameters

comma-separated list of arguments

Measurement function arguments, specified as a comma-separated list of arguments. These arguments are the same ones that are passed into the measurement function specified by the `MeasurementFcn` property of the tracking filter. If `filter` is a `trackingKF` or `trackingABF` object, then you cannot specify `measparams`.

Suppose you set `MeasurementFcn` to `@cameas`, and then call `correct`:

```
[xcorr,Pcorr] = correct(filter,frame,sensorpos,sensorvel)
```

The `correct` function internally calls the following:

```
meas = cameas(state,frame,sensorpos,sensorvel)
```

zcov — Measurement covariance*M*-by-*M* matrix

Measurement covariance, specified as an *M*-by-*M* matrix, where *M* is the dimension of the measurement. The same measurement covariance matrix is assumed for all measurements in `zmeas`.

Data Types: `single` | `double`

Output Arguments**xcorr — Corrected state of filter**

vector | matrix

Corrected state of the filter, specified as a vector or matrix. The `State` property of the input `filter` is overwritten with this value.

Pcorr — Corrected state covariance of filter

vector | matrix

Corrected state covariance of the filter, specified as a vector or matrix. The `StateCovariance` property of the input `filter` is overwritten with this value.

zcorr — Corrected measurement of filter

vector | matrix

Corrected measurement of the filter, specified as a vector or matrix. You can return `zcorr` only when `filter` is a `trackingABF` object.

Extended Capabilities

C/C++ Code Generation

Generate C and C++ code using MATLAB® Coder™.

See Also

[clone](#) | [correctjpda](#) | [distance](#) | [initialize](#) | [likelihood](#) | [predict](#) | [residual](#)

Introduced in R2018b

correctjpda

Correct state and state estimation error covariance using tracking filter and JPDA

Syntax

```
[xcorr,Pcorr] = correctjpda(filter,zmeas)
[xcorr,Pcorr] = correctjpda(filter,zmeas,jpdacoeffs,measparams)
[xcorr,Pcorr] = correctjpda(filter,zmeas,jpdacoeffs,zcov)
[xcorr,Pcorr,zcorr] = correctjpda(filter,zmeas,jpdacoeffs)
[xcorr,Pcorr,zcorr] = correctjpda(filter,zmeas,jpdacoeffs,zcov)

correctjpda(filter,___)
xcorr = correctjpda(filter,___)
```

Description

`[xcorr,Pcorr] = correctjpda(filter,zmeas)` returns the corrected state, `xcorr`, and the corrected state estimation error covariance, `Pcorr`, for the next time step of the input tracking filter. The corrected values are based on a set of measurements, `zmeas`, and their joint probabilistic data association coefficients, `jpdacoeffs`. These values overwrite the internal state and state estimation error covariance of `filter`.

`[xcorr,Pcorr] = correctjpda(filter,zmeas,jpdacoeffs,measparams)` specifies additional parameters used by the measurement function that is defined in the `MeasurementFcn` property of the tracking filter object.

If `filter` is a `trackingKF` or `trackingABF` object, then you cannot use this syntax.

`[xcorr,Pcorr] = correctjpda(filter,zmeas,jpdacoeffs,zcov)` specifies additional measurement covariance, `zcov`, used in the `MeasurementNoise` property of `filter`.

You can use this syntax only when `filter` is a `trackingKF` object.

`[xcorr,Pcorr,zcorr] = correctjpda(filter,zmeas,jpdacoeffs)` also returns the correction of measurements, `zcorr`.

You can use this syntax only when `filter` is a `trackingABF` object.

`[xcorr,Pcorr,zcorr] = correctjpda(filter,zmeas,jpdacoeffs,zcov)` returns the correction of measurements, `zcorr`, and also specifies additional measurement covariance, `zcov`, used in the `MeasurementNoise` property of `filter`.

You can use this syntax only when `filter` is a `trackingABF` object.

`correctjpda(filter,___)` updates `filter` with the corrected state and state estimation error covariance without returning the corrected values. Specify the tracking filter and any of the input argument combinations from preceding syntaxes.

`xcorr = correctjpd(filter, ___)` updates `filter` with the corrected state and state estimation error covariance but returns only the corrected state, `xcorr`.

Input Arguments

filter — Filter for object tracking

`trackingKF` object | `trackingEKF` object | `trackingUKF` object | `trackingABF` object | `trackingCKF` object | `trackingIMM` object | `trackingGSF` object | `trackingPF` object | `trackingMSCEKF` object

Filter for object tracking, specified as one of these objects:

- `trackingKF` — Linear Kalman filter
- `trackingEKF` — Extended Kalman filter
- `trackingUKF` — Unscented Kalman filter
- `trackingABF` — Alpha-beta filter
- `trackingCKF` — Cubature Kalman filter
- `trackingIMM` — Interacting multiple model (IMM) filter
- `trackingGSF` — Gaussian-sum filter
- `trackingPF` — Particle filter
- `trackingMSCEKF` — Extended Kalman filter using modified spherical coordinates (MSC)

zmeas — Measurements

M-by-*N* matrix

Measurements, specified as an *M*-by-*N* matrix, where *M* is the dimension of a single measurement, and *N* is the number of measurements.

Data Types: `single` | `double`

jpdacoeffs — Joint probabilistic data association coefficients

(*N*+1)-element vector

Joint probabilistic data association coefficients, specified as an (*N*+1)-element vector. The *i*th (*i* = 1, ..., *N*) element of `jpdacoeffs` is the joint probability that the *i*th measurement in `zmeas` is associated with the filter. The last element of `jpdacoeffs` corresponds to the probability that no measurement is associated with the filter. The sum of all elements of `jpdacoeffs` must equal 1.

Data Types: `single` | `double`

zcov — Measurement covariance

M-by-*M* matrix

Measurement covariance, specified as an *M*-by-*M* matrix, where *M* is the dimension of the measurement. The same measurement covariance matrix is assumed for all measurements in `zmeas`.

Data Types: `single` | `double`

measparams — Measurement parameters

comma-separated list of arguments

Measurement function arguments, specified as a comma-separated list of arguments. These arguments are the same ones that are passed into the measurement function specified by the

MeasurementFcn property of the tracking filter. If `filter` is a `trackingKF` or `trackingABF` object, then you cannot specify `measparams`.

Suppose you set `MeasurementFcn` to `@cameas`, and then call `correctjpdo`:

```
[xcorr,Pcorr] = correctjpdo(filter,frame,sensorpos,sensorvel)
```

The `correctjpdo` function internally calls the following:

```
meas = cameas(state,frame,sensorpos,sensorvel)
```

Output Arguments

xcorr — Corrected state

P-element vector

Corrected state, returned as a *P*-element vector, where *P* is the dimension of the estimated state. The corrected state represents the *a posteriori* estimate of the state vector, taking into account the current measurements and their associated probabilities.

Pcorr — Corrected state error covariance

positive-definite *P*-by-*P* matrix

Corrected state error covariance, returned as a positive-definite *P*-by-*P* matrix, where *P* is the dimension of the state estimate. The corrected state covariance matrix represents the *a posteriori* estimate of the state covariance matrix, taking into account the current measurements and their associated probabilities.

zcorr — Corrected measurements

M-by-*N* matrix

Corrected measurements, returned as an *M*-by-*N* matrix, where *M* is the dimension of a single measurement, and *N* is the number of measurements. You can return `zcorr` only when `filter` is a `trackingABF` object.

More About

JPDA Correction Algorithm for Discrete Extended Kalman Filter

In the measurement update of a regular Kalman filter, the filter usually only needs to update the state and covariance based on one measurement. For instance, the equations for measurement update of a discrete extended Kalman filter can be given as

$$\begin{aligned}x_k^+ &= x_k^- + K_k(y - h(x_k^-)) \\ P_k^+ &= P_k^- - K_k S_k K_k^T\end{aligned}$$

where x_k^- and x_k^+ are the a priori and a posteriori state estimates, respectively, K_k is the Kalman gain, y is the actual measurement, and $h(x_k^-)$ is the predicted measurement. P_k^- and P_k^+ are the a priori and a posteriori state error covariance matrices, respectively. The innovation matrix S_k is defined as

$$S_k = H_k P_k^- H_k^T$$

where H_k is the Jacobian matrix for the measurement function h .

In the workflow of a JPDA tracker, the filter needs to process multiple probable measurements y_i ($i = 1, \dots, N$) with varied probabilities of association β_i ($i = 0, 1, \dots, N$). Note that β_0 is the probability that no measurements is associated with the filter. The measurement update equations for a discrete extended Kalman filter used for a JPDA tracker are

$$x_k^+ = x_k^- + K_k \sum_{i=1}^N \beta_i (y_i - h(x_k^-))$$

$$P_k^+ = P_k^- - (1 - \beta_0) K_k S_k K_k^T + P_k$$

where

$$P_k = K_k \sum_{i=1}^N \left[\beta_i (y_i - h(x_k^-))(y_i - h(x_k^-))^T - (\delta y)(\delta y)^T \right] K_k^T$$

and

$$\delta y = \sum_{j=1}^N \beta_j (y_j - h(x_k^-))$$

Note that these equations only apply to `trackingEKF` and are not the exact equations used in other tracking filters.

References

- [1] Fortmann, T., Y. Bar-Shalom, and M. Scheffe. "Sonar Tracking of Multiple Targets Using Joint Probabilistic Data Association." *IEEE Journal of Ocean Engineering*. Vol. 8, Number 3, 1983, pp. 173-184.

Extended Capabilities

C/C++ Code Generation

Generate C and C++ code using MATLAB® Coder™.

Usage notes and limitations:

`correctjpda` supports only double-precision code generation, not single-precision.

See Also

`clone` | `correct` | `distance` | `initialize` | `likelihood` | `predict` | `residual` | `trackerJPDA`

Introduced in R2019a

distance

Distances between current and predicted measurements of tracking filter

Syntax

```
dist = distance(filter,zmeas)
dist = distance(filter,zmeas,measparams)
```

Description

`dist = distance(filter,zmeas)` computes the normalized distances between one or more current object measurements, `zmeas`, and the corresponding predicted measurements computed by the input `filter`. Use this function to assign measurements to tracks.

This distance computation takes into account the covariance of the predicted state and the measurement noise.

`dist = distance(filter,zmeas,measparams)` specifies additional parameters that are used by the `MeasurementFcn` of the filter.

If `filter` is a `trackingKF` or `trackingABF` object, then you cannot use this syntax.

Input Arguments

filter — Filter for object tracking

`trackingKF` object | `trackingEKF` object | `trackingUKF` object | `trackingABF` object | `trackingCKF` object | `trackingIMM` object | `trackingGSF` object | `trackingPF` object | `trackingMSCEKF` object

Filter for object tracking, specified as one of these objects:

- `trackingKF` — Linear Kalman filter
- `trackingEKF` — Extended Kalman filter
- `trackingUKF` — Unscented Kalman filter
- `trackingABF` — Alpha-beta filter
- `trackingCKF` — Cubature Kalman filter
- `trackingIMM` — Interacting multiple model (IMM) filter
- `trackingGSF` — Gaussian-sum filter
- `trackingPF` — Particle filter
- `trackingMSCEKF` — Extended Kalman filter using modified spherical coordinates (MSC)

zmeas — Measurements of tracked objects

matrix

Measurements of tracked objects, specified as a matrix. Each row of the matrix contains a measurement vector.

measparams — Parameters for measurement function

cell array

Parameters for measurement function, specified as a cell array. The parameters are passed to the measurement function that is defined in the `MeasurementFcn` property of the `filter`. If `filter` is a `trackingKF` or `trackingABF` object, then you cannot specify `measparams`.

Suppose you set the `MeasurementFcn` property of `filter` to `@cameas`, and then set these values:

```
measurementParams = {frame,sensorpos,sensorpos}
```

The `distance` function internally calls the following:

```
cameas(state,frame,sensorpos,sensorvel)
```

Output Arguments**dist — Distances between measurements**

row vector

Distances between measurements, returned as a row vector. Each element corresponds to a distance between the predicted measurement in the input `filter` and a measurement contained in a row of `zmeas`.

Algorithms

The `distance` function computes the normalized distance between the filter object and a set of measurements. This distance computation is a variant of the Mahalanobis distance and takes into account the residual (the difference between the object measurement and the value predicted by the filter), the residual covariance, and the measurement noise.

Consider an extended Kalman filter with state x and measurement z . The equations used to compute the residual, z_{res} , and the residual covariance, S , are

$$\begin{aligned} z_{\text{res}} &= z - h(x), \\ S &= R + HPH^T, \end{aligned}$$

where:

- h is the measurement function defined in the `MeasurementFcn` property of the filter.
- R is the measurement noise covariance defined in the `MeasurementNoise` property of the filter.
- H is the Jacobian of the measurement function defined in the `MeasurementJacobianFcn` property of the filter.

The residual covariance calculation for other filters can vary slightly from the one shown because tracking filters have different ways of propagating the covariance to the measurement space. For example, instead of using the Jacobian of the measurement function to propagate the covariance, unscented Kalman filters sample the covariance, and then propagate the sampled points.

The equation for the Mahalanobis distance, d^2 , is

$$d^2 = z_{\text{res}}^T S^{-1} z_{\text{res}}$$

The distance function computes the normalized distance, d_n , as

$$d_n = d^2 + \log(|S|),$$

where $\log(|S|)$ is the logarithm of the determinant of residual covariance S .

The $\log(|S|)$ term accounts for tracks that are coasted, meaning that they are predicted but have not had an update for a long time. Tracks in this state can make S very large, resulting in a smaller Mahalanobis distance relative to the updated tracks. This difference in distance values can cause the coasted tracks to incorrectly take detections from the updated tracks. The $\log(|S|)$ term compensates for this effect by penalizing such tracks, whose predictions are highly uncertain.

Extended Capabilities

C/C++ Code Generation

Generate C and C++ code using MATLAB® Coder™.

See Also

`clone` | `correct` | `correctjpda` | `initialize` | `likelihood` | `predict` | `residual`

Introduced in R2018b

initialize

Initialize state and covariance of tracking filter

Syntax

```
initialize(filter, state, statecov)
initialize(filter, state, statecov, Name, Value)
```

Description

`initialize(filter, state, statecov)` initializes the filter by setting the `State` and `StateCovariance` properties of the filter with the corresponding `state` and `statecov` inputs.

`initialize(filter, state, statecov, Name, Value)` also initializes properties of `filter` by using one or more name-value pairs. Specify the name of the filter property and the value to which you want to initialize it. You cannot change the size or type of the properties that you initialize.

Input Arguments

filter — Filter for object tracking

`trackingKF` object | `trackingEKF` object | `trackingUKF` object | `trackingIMM` object | `trackingPF` object | `trackingMSCEKF` object

Filter for object tracking, specified as one of these objects:

- `trackingKF` — Linear Kalman filter
- `trackingEKF` — Extended Kalman filter
- `trackingUKF` — Unscented Kalman filter
- `trackingIMM` — Interacting multiple model (IMM) filter
- `trackingPF` — Particle filter
- `trackingMSCEKF` — Extended Kalman filter using modified spherical coordinates (MSC)

state — Filter state

real-valued M -element vector

Filter state, specified as a real-valued M -element vector, where M is the size of the filter state.

Example: `[200; 0.2]`

Data Types: `double`

statecov — State estimation error covariance

positive-definite real-valued M -by- M matrix

State estimation error covariance, specified as a positive-definite real-valued M -by- M matrix. M is the size of the filter state. The covariance matrix represents the uncertainty in the filter state.

Example: `[20 0.1; 0.1 1]`

Extended Capabilities

C/C++ Code Generation

Generate C and C++ code using MATLAB® Coder™.

See Also

`clone` | `correct` | `correctjpda` | `distance` | `likelihood` | `predict` | `residual`

Introduced in R2018b

likelihood

Likelihood of measurement from tracking filter

Syntax

```
measlikelihood = likelihood(filter,zmeas)
measlikelihood = likelihood(filter,zmeas,measparams)
```

Description

`measlikelihood = likelihood(filter,zmeas)` returns the likelihood of a measurement, `zmeas`, that was produced by the specified filter, `filter`.

`measlikelihood = likelihood(filter,zmeas,measparams)` specifies additional parameters that are used by the `MeasurementFcn` of the filter.

If `filter` is a `trackingKF` or `trackingABF` object, then you cannot use this syntax.

Input Arguments

filter — Filter for object tracking

`trackingKF` object | `trackingEKF` object | `trackingUKF` object | `trackingABF` object | `trackingCKF` object | `trackingIMM` object | `trackingGSF` object | `trackingPF` object | `trackingMSCEKF` object

Filter for object tracking, specified as one of these objects:

- `trackingKF` — Linear Kalman filter
- `trackingEKF` — Extended Kalman filter
- `trackingUKF` — Unscented Kalman filter
- `trackingABF` — Alpha-beta filter
- `trackingCKF` — Cubature Kalman filter
- `trackingIMM` — Interacting multiple model (IMM) filter
- `trackingGSF` — Gaussian-sum filter
- `trackingPF` — Particle filter
- `trackingMSCEKF` — Extended Kalman filter using modified spherical coordinates (MSC)

zmeas — Current measurement of tracked object

vector | matrix

Current measurement of a tracked object, specified a vector or matrix.

measparams — Parameters for measurement function

cell array

Parameters for measurement function, specified as a cell array. The parameters are passed to the measurement function that is defined in the `MeasurementFcn` of the input filter. If `filter` is a `trackingKF` or `trackingABF` object, then you cannot specify `measparams`.

Output Arguments

measlikelihood — Likelihood of measurement

scalar

Likelihood of measurement, returned as a scalar.

Extended Capabilities

C/C++ Code Generation

Generate C and C++ code using MATLAB® Coder™.

See Also

`clone` | `correct` | `correctjpda` | `distance` | `initialize` | `predict` | `residual`

Introduced in R2018b

predict

Predict state and state estimation error covariance of tracking filter

Syntax

```
[xpred,Ppred] = predict(filter)
[xpred,Ppred] = predict(filter,dt)
[xpred,Ppred] = predict(filter,predparams)

[xpred,Ppred,zpred] = predict(filter)
[xpred,Ppred,zpred] = predict(filter,dt)

predict(filter, ___)
xpred = predict(filter, ___)
```

Description

`[xpred,Ppred] = predict(filter)` returns the predicted state, `xpred`, and the predicted state estimation error covariance, `Ppred`, for the next time step of the input tracking filter. The predicted values overwrite the internal state and state estimation error covariance of `filter`.

`[xpred,Ppred] = predict(filter,dt)` specifies the time step as a positive scalar in seconds, and returns one or more of the outputs from the preceding syntaxes.

`[xpred,Ppred] = predict(filter,predparams)` specifies additional prediction parameters used by the state transition function. The state transition function is defined in the `StateTransitionFcn` property of `filter`.

`[xpred,Ppred,zpred] = predict(filter)` also returns the predicted measurement at the next time step.

You can use this syntax only when `filter` is a `trackingABF` object.

`[xpred,Ppred,zpred] = predict(filter,dt)` returns the predicted state, state estimation error covariance, and measurement at the specified time step.

You can use this syntax only when `filter` is a `trackingABF` object.

`predict(filter, ___)` updates `filter` with the predicted state and state estimation error covariance without returning the predicted values. Specify the tracking filter and any of the input argument combinations from preceding syntaxes.

`xpred = predict(filter, ___)` updates `filter` with the predicted state and state estimation error covariance but returns only the predicted state, `xpred`.

Examples

Constant-Velocity Extended Kalman Filter

Create a two-dimensional `trackingEKF` object and use name-value pairs to define the `StateTransitionJacobianFcn` and `MeasurementJacobianFcn` properties. Use the predefined constant-velocity motion and measurement models and their Jacobians.

```
EKF = trackingEKF(@constvel,@cvmeas,[0;0;0;0], ...
    'StateTransitionJacobianFcn',@constveljac, ...
    'MeasurementJacobianFcn',@cvmeasjac);
```

Run the filter. Use the `predict` and `correct` functions to propagate the state. You may call `predict` and `correct` in any order and as many times you want. Specify the measurement in Cartesian coordinates.

```
measurement = [1;1;0];
[xpred, Ppred] = predict(EKF);
[xcorr, Pcorr] = correct(EKF,measurement);
[xpred, Ppred] = predict(EKF);
[xpred, Ppred] = predict(EKF)
```

xpred = 4×1

```
1.2500
0.2500
1.2500
0.2500
```

Ppred = 4×4

```
11.7500    4.7500         0         0
 4.7500    3.7500         0         0
         0         0    11.7500    4.7500
         0         0     4.7500    3.7500
```

Input Arguments

filter — Filter for object tracking

`trackingEKF` object | `trackingUKF` object | `trackingABF` object | `trackingCKF` object | `trackingIMM` object | `trackingGSF` object | `trackingPF` object | `trackingMSCEKF` object

Filter for object tracking, specified as one of these objects:

- `trackingEKF` — Extended Kalman filter
- `trackingUKF` — Unscented Kalman filter
- `trackingABF` — Alpha-beta filter
- `trackingCKF` — Cubature Kalman filter
- `trackingIMM` — Interacting multiple model (IMM) filter
- `trackingGSF` — Gaussian-sum filter
- `trackingPF` — Particle filter
- `trackingMSCEKF` — Extended Kalman filter using modified spherical coordinates (MSC)

To use the `predict` function with a `trackingKF` linear Kalman filter, see `predict (trackingKF)`.

dt — Time step

positive scalar

Time step for next prediction, specified as a positive scalar in seconds.

predparams — Prediction parameters

comma-separated list of arguments

Prediction parameters used by the state transition function, specified as a comma-separated list of arguments. These arguments are the same arguments that are passed into the state transition function specified by the `StateTransitionFcn` property of the input `filter`.

Suppose you set the `StateTransitionFcn` property to `@constacc` and then call the `predict` function:

```
[xpred,Ppred] = predict(filter,dt)
```

The `predict` function internally calls the following:

```
state = constacc(state,dt)
```

Output Arguments

xpred — Predicted state of filter

vector | matrix

Predicted state of the filter, specified as a vector or matrix. The `State` property of the input `filter` is overwritten with this value.

Ppred — Predicted state covariance of filter

vector | matrix

Predicted state covariance of the filter, specified as a vector or matrix. The `StateCovariance` property of the input `filter` is overwritten with this value.

zpred — Predicted measurement

vector | matrix

Predicted measurement, specified as a vector or matrix. You can return `zpred` only when `filter` is a `trackingABF` object.

Extended Capabilities

C/C++ Code Generation

Generate C and C++ code using MATLAB® Coder™.

See Also

`clone` | `correct` | `correctjpda` | `distance` | `initialize` | `likelihood` | `residual`

Introduced in R2018b

predict

Predict state and state estimation error covariance of linear Kalman filter

Syntax

```
[xpred,Ppred] = predict(filter)

[xpred,Ppred] = predict(filter,u)
[xpred,Ppred] = predict(filter,F)
[xpred,Ppred] = predict(filter,F,Q)
[xpred,Ppred] = predict(filter,u,F,G)
[xpred,Ppred] = predict(filter,u,F,G,Q)

[xpred,Ppred] = predict(filter,dt)
[xpred,Ppred] = predict(filter,u,dt)

predict(filter, __)
xpred = predict(filter, __)
```

Description

`[xpred,Ppred] = predict(filter)` returns the predicted state, `xpred`, and the predicted state estimation error covariance, `Ppred`, for the next time step of the input linear Kalman filter. The predicted values overwrite the internal state and state estimation error covariance of `filter`.

This syntax applies when you set the `ControlModel` property of `filter` to an empty matrix.

`[xpred,Ppred] = predict(filter,u)` specifies a control input, or force, `u`, and returns one or more of the outputs from the preceding syntaxes.

This syntax applies when you set the `ControlModel` property of `filter` to a nonempty matrix.

`[xpred,Ppred] = predict(filter,F)` specifies the state transition model, `F`. Use this syntax to change the state transition model during a simulation.

This syntax applies when you set the `ControlModel` property of `filter` to an empty matrix.

`[xpred,Ppred] = predict(filter,F,Q)` specifies the state transition model, `F`, and the process noise covariance, `Q`. Use this syntax to change the state transition model and process noise covariance during a simulation.

This syntax applies when you set the `ControlModel` property of `filter` to an empty matrix.

`[xpred,Ppred] = predict(filter,u,F,G)` specifies the force or control input, `u`, the state transition model, `F`, and the control model, `G`. Use this syntax to change the state transition model and control model during a simulation.

This syntax applies when you set the `ControlModel` property of `filter` to a nonempty matrix.

`[xpred,Ppred] = predict(filter,u,F,G,Q)` specifies the force or control input, `u`, the state transition model, `F`, the control model, `G`, and the process noise covariance, `Q`. Use this syntax to change the state transition model, control model, and process noise covariance during a simulation.

This syntax applies when you set the `ControlModel` property of `filter` to a nonempty matrix.

`[xpred,Ppred] = predict(filter,dt)` returns the predicted outputs after time step `dt`.

This syntax applies when the `MotionModel` property of `filter` is not set to 'Custom' and the `ControlModel` property is set to an empty matrix.

`[xpred,Ppred] = predict(filter,u,dt)` also specifies a force or control input, `u`.

This syntax applies when the `MotionModel` property of `filter` is not set to 'Custom' and the `ControlModel` property is set to a nonempty matrix.

`predict(filter, __)` updates `filter` with the predicted state and state estimation error covariance without returning the predicted values. Specify the tracking filter and any of the input argument combinations from preceding syntaxes.

`xpred = predict(filter, __)` updates `filter` with the predicted state and state estimation error covariance but returns only the predicted state, `xpred`.

Examples

Constant-Velocity Linear Kalman Filter

Create a linear Kalman filter that uses a 2D Constant Velocity motion model. Assume that the measurement consists of the object's x-y location.

Specify the initial state estimate to have zero velocity.

```
x = 5.3;
y = 3.6;
initialState = [x;0;y;0];
KF = trackingKF('MotionModel','2D Constant Velocity','State',initialState);
```

Create the measured positions from a constant-velocity trajectory.

```
vx = 0.2;
vy = 0.1;
T = 0.5;
pos = [0:vx*T:2;5:vy*T:6]';
```

Predict and correct the state of the object.

```
for k = 1:size(pos,1)
    pstates(k,:) = predict(KF,T);
    cstates(k,:) = correct(KF,pos(k,:));
end
```

Plot the tracks.

```
plot(pos(:,1),pos(:,2),'k.', pstates(:,1),pstates(:,3),'+', ...
      cstates(:,1),cstates(:,3),'o')
```

```

xlabel('x [m]')
ylabel('y [m]')
grid
xt = [x-2 pos(1,1)+0.1 pos(end,1)+0.1];
yt = [y pos(1,2) pos(end,2)];
text(xt,yt,{'First measurement', 'First position', 'Last position'})
legend('Object position', 'Predicted position', 'Corrected position')

```

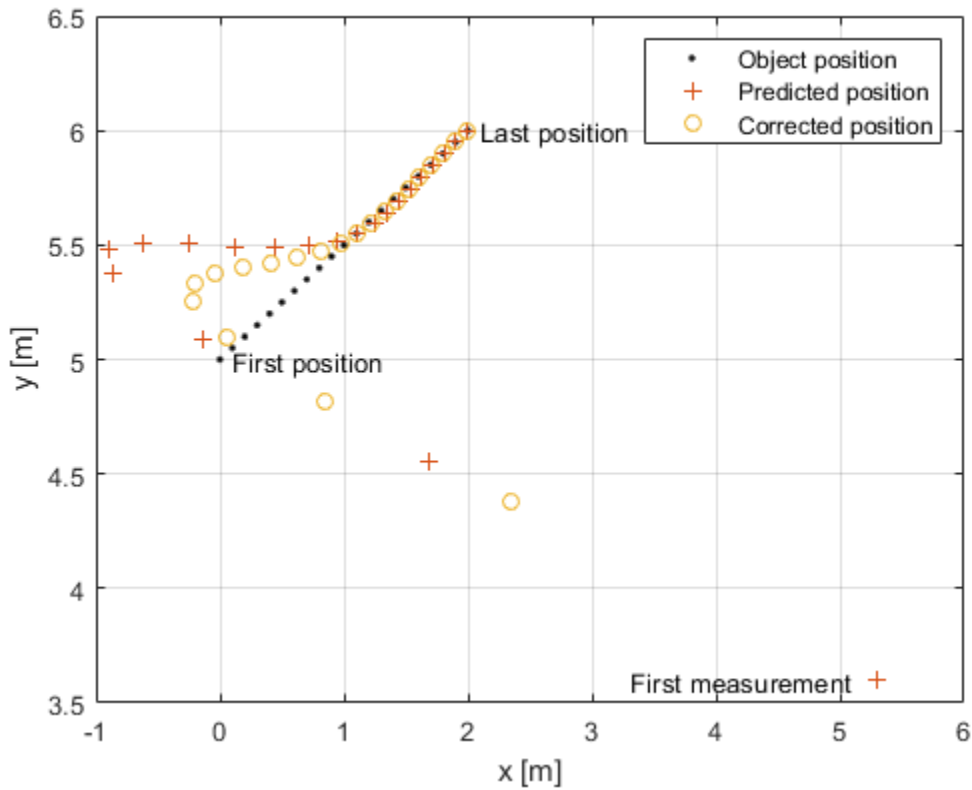

Input Arguments

filter — Linear Kalman filter for object tracking

trackingKF object

Linear Kalman filter for object tracking, specified as a trackingKF object.

u — Control vector

real-valued L -element vector

Control vector, specified as a real-valued L -element vector.

F — State transition model

real-valued M -by- M matrix

State transition model, specified as a real-valued M -by- M matrix, where M is the size of the state vector.

Q — Process noise covariance matrix

positive-definite, real-valued M -by- M matrix

Process noise covariance matrix, specified as a positive-definite, real-valued M -by- M matrix, where M is the length of the state vector.

G — Control model

real-valued M -by- L matrix

Control model, specified as a real-valued M -by- L matrix. M is the size of the state vector. L is the number of independent controls.

dt — Time step

positive scalar

Time step, specified as a positive scalar. Units are in seconds.

Output Arguments**xpred — Predicted state**

real-valued M -element vector

Predicted state, returned as a real-valued M -element vector. The predicted state represents the deducible estimate of the state vector, propagated from the previous state using the state transition and control models.

Ppred — Predicted state error covariance matrix

real-valued M -by- M matrix

Predicted state covariance matrix, specified as a real-valued M -by- M matrix. M is the size of the state vector. The predicted state covariance matrix represents the *deducible* estimate of the covariance matrix vector. The filter propagates the covariance matrix from the previous estimate.

Extended Capabilities**C/C++ Code Generation**

Generate C and C++ code using MATLAB® Coder™.

See Also

[clone](#) | [correct](#) | [correctjpda](#) | [distance](#) | [initialize](#) | [likelihood](#) | [residual](#)

Introduced in R2018b

residual

Measurement residual and residual noise from tracking filter

Syntax

```
[zres, rescov] = residual(filter, zmeas)
[zres, rescov] = residual(filter, zmeas, measparams)
```

Description

`[zres, rescov] = residual(filter, zmeas)` computes the residual and residual covariance of the current given measurement, `zmeas`, with the predicted measurement in the tracking filter, `filter`. This function applies to filters that assume a Gaussian distribution for noise.

`[zres, rescov] = residual(filter, zmeas, measparams)` specifies additional parameters that are used by the `MeasurementFcn` of the filter.

If `filter` is a `trackingKF` object, then you cannot use this syntax.

Input Arguments

filter — Filter for object tracking

`trackingKF` object | `trackingEKF` object | `trackingUKF` object | `trackingCKF` object | `trackingMSCEKF` object

Filter for object tracking, specified as one of these objects:

- `trackingKF` — Linear Kalman filter
- `trackingEKF` — Extended Kalman filter
- `trackingUKF` — Unscented Kalman filter
- `trackingCKF` — Cubature Kalman filter
- `trackingMSCEKF` — Extended Kalman filter using modified spherical coordinates (MSC)

zmeas — Current measurement of tracked object

vector | matrix

Current measurement of a tracked object, specified as a vector or matrix.

measparams — Parameters for measurement function

cell array

Parameters for measurement function, specified as a cell array. The parameters are passed to the measurement function that is defined in the `MeasurementFcn` property of the input `filter`. If `filter` is a `trackingKF` object, then you cannot specify `measparams`.

Output Arguments

zres — Residual between current and predicted measurement

matrix

Residual between current and predicted measurement, returned as a matrix.

rescov — Residual covariance

matrix

Residual covariance, returned as a matrix.

Algorithms

The residual is the difference between a measurement and the value predicted by the filter. For Kalman filters, the residual calculation depends on whether the filter is linear or nonlinear.

Linear Kalman Filters

Given a linear Kalman filter with a current measurement of z , the residual z_{res} is defined as

$$z_{\text{res}} = z - Hx,$$

where:

- H is the measurement model set by the `MeasurementModel` property of the filter.
- x is the current filter state.

The covariance of the residual, S , is defined as

$$S = R + HPHT,$$

where:

- P is the state covariance matrix.
- R is the measurement noise matrix set by the `MeasurementNoise` property of the filter.

Nonlinear Kalman Filters

Given a nonlinear Kalman filter with a current measurement of z , the residual z_{res} is defined as:

$$z_{\text{res}} = z - h(x),$$

where:

- h is the measurement function set by the `MeasurementFcn` property.
- x is the current filter state.

The covariance of the residual, S , is defined as:

$$S = R + R_p,$$

where:

- R is the measurement noise matrix set by the `MeasurementNoise` property of the filter.
- R_p is the state covariance matrix projected onto the measurement space.

Extended Capabilities

C/C++ Code Generation

Generate C and C++ code using MATLAB® Coder™.

See Also

`clone` | `correct` | `correctjpd` | `distance` | `initialize` | `likelihood` | `predict`

Introduced in R2018b

singer

Singer acceleration motion model

Syntax

```
updatedstates = singer(states)
updatedstates = singer(states,dt)
updatedstates = singer(states,dt,tau)
```

Description

`updatedstates = singer(states)` returns the updated states from the current `states` based on the Singer acceleration motion model. The default time step is 1 second.

`updatedstates = singer(states,dt)` specifies the time step, `dt`, in seconds.

`updatedstates = singer(states,dt,tau)` specifies the target maneuver time constant, `tau`, in seconds. The default target maneuver time constant is 20 seconds.

Examples

Predict Multiple Singer Acceleration States

Define a state matrix for a 2-D Singer acceleration motion.

```
states = [1 2 2.5;1 2.5 3;0 -1 2;2 3 -1;5 0 3;-2 4 2];
```

Predict the states by using a default time step interval `dt = 1` second.

```
states = singer(states)
```

```
states = 6×3
```

```

    2.0000    4.0082    6.4835
    1.0000    1.5246    4.9508
         0   -0.9512    1.9025
    6.0165    4.9671    2.9835
    3.0492    3.9016    4.9508
   -1.9025    3.8049    1.9025
```

Predict the state by using `dt = 0.1` second.

```
states = singer(states,0.1)
```

```
states = 6×3
```

```

    2.1000    4.1559    6.9881
    1.0000    1.4297    5.1406
         0   -0.9465    1.8930
    6.3119    5.3762    3.4881
```

```
2.8594    4.2812    5.1406  
-1.8930    3.7859    1.8930
```

Predict and Measure Position Using Singer Model

Define a state vector for a 2-D Singer acceleration motion.

```
state = [10;-10;3;0;10;-3];  
dt = 0.2; % time step in seconds  
tau = 10; % maneuver time in seconds
```

Use the `singer` function to create a trajectory and measure the positions using the `singermeas` function.

```
positions = zeros(2,100); % Pre-allocate memory  
measurements = zeros(3,100); % Pre-allocate memory  
for i = 1:1:100  
    state = singer(state, dt, tau);  
    positions(:,i) = [state(1); state(4)];  
    measurements(:,i) = singermeas(state);  
end
```

Visualize the results.

```
plot(positions(1,:), positions(2,:))  
hold on  
plot(measurements(1,:), measurements(2,:), '.')  
title('Singer Acceleration Model');  
xlabel('X[m]'); ylabel('Y[m]');  
legend('Trajectory', 'Measurements');
```

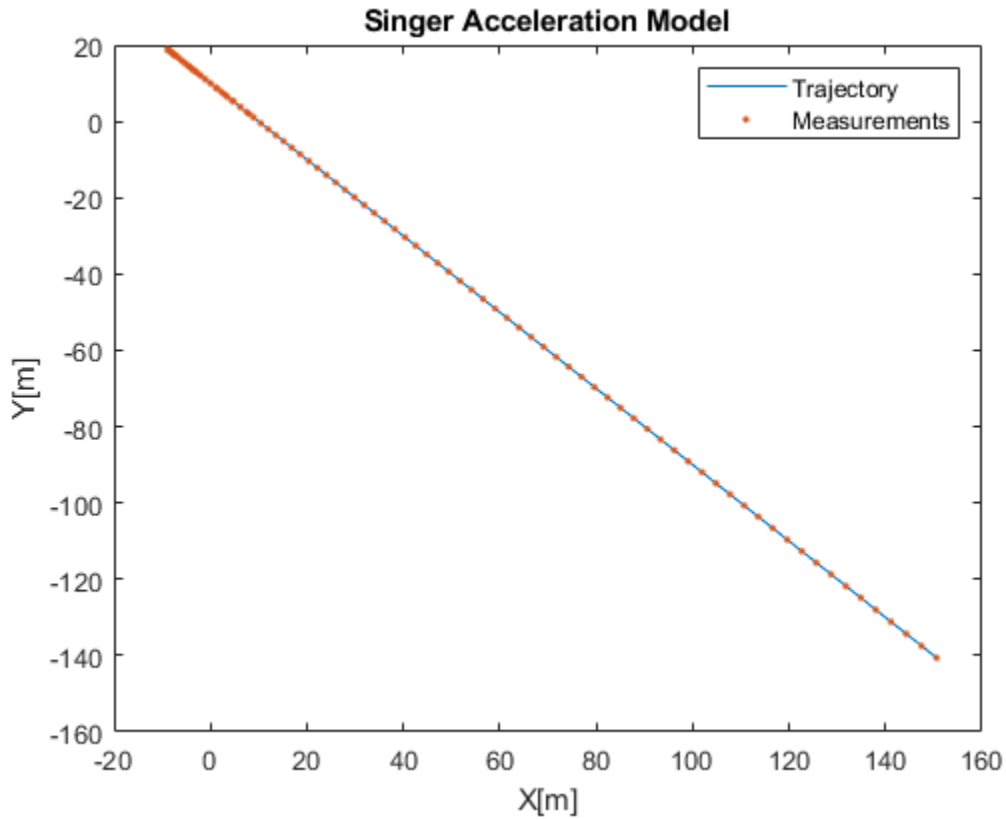

Input Arguments

states — Current states

real-valued $3N$ -by-1 vector | real-valued $3N$ -by- M matrix

Current states, specified as a real-valued $3N$ -by-1 vector or a real-valued $3N$ -by- M matrix. N is the spatial degree of the state, and M is the number of states.

The state vector in each column takes different forms based on its spatial dimensions.

Spatial Degrees	State Vector Structure
1-D	[x; vx; ax]
2-D	[x; vx; ax; y; vy; ay]
3-D	[x; vx; ax; y; vy; ay; z; vz; az]

For example, x represents the x -coordinate, v_x represents the velocity in the x -direction, and a_x represents the acceleration in the x -direction. If the motion model is in one-dimensional space, the y - and z -axes are assumed to be zero. If the motion model is in two-dimensional space, values along the z -axis are assumed to be zero. Position coordinates are in meters. Velocity coordinates are in meters/second. Acceleration coordinates are in m/s^2 .

Example: [5;0.1;0.01;0;-0.2;-0.01;-3;0.05;0]

dt — Time step

1.0 (default) | positive scalar

Time step, specified as a positive scalar in seconds.

Example: 0.5

tau — Target maneuver time constant20 (default) | positive scalar | N -element vector of scalarTarget maneuver time constant, specified as a positive scalar or an N -element vector of scalars in seconds. N is the spatial degree of the state. When specified as a vector, each element applies to the corresponding spatial dimension.

Example: 30

Output Arguments**updatedstates — Updated states**real-valued $3N$ -by-1 vector | real-valued $3N$ -by- M matrixUpdated states, returned as a real-valued $3N$ -by-1 vector or a real-valued $3N$ -by- M matrix. N is the spatial degree of the state, and M is the number of states. The `updatedStates` output has the exactly same form as the `states` input.**Algorithms**The Singer acceleration model assumes the acceleration at time step $k+1$, which depends on the acceleration at time step k with exponential decay as:

$$a(k+1) = a(k) * \exp(-T/\tau)$$

where $a(k)$ is the acceleration at time step k , T is the time step, and τ is the target maneuver time constant.For a 1-D singer model state $p = [x, vx, ax]^T$, the state propagation is:

$$p(k) = \begin{bmatrix} 1 & T & (\alpha T - 1 - e^{-\alpha T})/\alpha^2 \\ 0 & 1 & (1 - e^{-\alpha T})/\alpha \\ 0 & 0 & e^{-\alpha T} \end{bmatrix} p(k) + w(k)$$

where $\alpha = 1/\tau$ is the reciprocal of the target maneuver time constant and $w(k)$ is the Singer model process noise at time step k . See `singerProcessNoise` for more details on the process noise.**References**

- [1] Singer, Robert A. "Estimating optimal tracking filter performance for manned maneuvering targets." IEEE Transactions on Aerospace and Electronic Systems 4 (1970): 473-483.
- [2] Blackman, Samuel S., and Robert Popoli. "Design and analysis of modern tracking systems." (1999).

- [3] Li, X. Rong, and Vesselin P. Jilkov. "*Survey of maneuvering target tracking: dynamic models.*" Signal and Data Processing of Small Targets 2000, vol. 4048, pp. 212-235. International Society for Optics and Photonics, 2000.

Extended Capabilities

C/C++ Code Generation

Generate C and C++ code using MATLAB® Coder™.

See Also

`initsingerekf` | `singerProcessNoise` | `singerjac` | `singermeas` | `singermeasjac`

Introduced in R2020b

singerjac

Jacobian of Singer acceleration motion model

Syntax

```
jacobian = singerjac(state)
jacobian = singerjac(state,dt)
jacobian = singerjac(state,dt,tau)
```

Description

`jacobian = singerjac(state)` returns the Jacobian matrix of the Singer motion model with respect to the state vector. The default time step is 1 second.

`jacobian = singerjac(state,dt)` specifies the time step `dt` in seconds.

`jacobian = singerjac(state,dt,tau)` specifies the target maneuver time constant, `tau`, in seconds. The default target maneuver time constant is 20 seconds.

Examples

Jacobian of Singer Model

Define a state for a 2-D Singer acceleration motion.

```
state = [1;1;1;2;1;0];
```

Calculate the Jacobian matrix assuming `dt = 1` second.

```
jac1 = singerjac(state)
```

```
jac1 = 6×6
```

```
    1.0000    1.0000    0.4918         0         0         0
         0    1.0000    0.9754         0         0         0
         0         0    0.9512         0         0         0
         0         0         0    1.0000    1.0000    0.4918
         0         0         0         0    1.0000    0.9754
         0         0         0         0         0    0.9512
```

Calculate the Jacobian matrix assuming `dt = 0.1` second.

```
jac2 = singerjac(state, 0.1)
```

```
jac2 = 6×6
```

```
    1.0000    0.1000    0.0050         0         0         0
         0    1.0000    0.0998         0         0         0
         0         0    0.9950         0         0         0
         0         0         0    1.0000    0.1000    0.0050
```

```

0      0      0      0      1.0000      0.0998
0      0      0      0      0      0.9950

```

Input Arguments

state — Current state

real-valued $3N$ -by-1 vector

Current state, specified as a real-valued $3N$ -by-1 vector. N is the spatial degree of the state. The state vector takes the different forms based on its dimensions.

Spatial Degrees	State Vector Structure
1-D	[x; vx; ax]
2-D	[x; vx; ax; y; vy; ay]
3-D	[x; vx; ax; y; vy; ay; z; vz; az]

For example, x represents the x -coordinate, v_x represents the velocity in the x -direction, and a_x represents the acceleration in the x -direction. If the motion model is in one-dimensional space, the y - and z -axes are assumed to be zero. If the motion model is in two-dimensional space, values along the z -axis are assumed to be zero. Position coordinates are in meters. Velocity coordinates are in m/s. Acceleration coordinates are in m/s^2 .

Example: [5;0.1;0.01;0;-0.2;-0.01;-3;0.05;0]

dt — Time step

1.0 (default) | positive scalar

Time step, specified as a positive scalar in seconds.

Example: 0.5

tau — Target maneuver time constant

20 (default) | positive scalar | N -element vector of scalar

Target maneuver time constant, specified as a positive scalar or an N -element vector of scalars in seconds. N is the spatial degree of the state. When specified as a vector, each element applies to the corresponding spatial dimension.

Example: 30

Output Arguments

jacobian — Jacobian matrix of Singer model

$3N$ -by- $3N$ matrix of real scalar

The Jacobian matrix of a Singer model, returned as a $3N$ -by- $3N$ matrix of real scalars. N is the spatial degree of the state input.

Algorithms

Given the dimension of the state space, the Jacobian of a Singer model takes different forms.

For 1-D state space, the Jacobian matrix is calculated as

$$J_1 = \begin{bmatrix} 1 & T & \tau^2(-T/\tau + \beta) \\ 0 & 1 & \tau(1 - \beta) \\ 0 & 0 & 0 \end{bmatrix}$$

where T is the time step interval, τ is the target maneuver time constant, and $\beta = \exp(-T/\tau)$.

For 2-D state space, the Jacobian matrix is calculated as

$$J_2 = \begin{bmatrix} J_1 & 0 \\ 0 & J_1 \end{bmatrix}$$

For 3-D state space, the Jacobian matrix is calculated as

$$J_3 = \begin{bmatrix} J_1 & 0 & 0 \\ 0 & J_1 & 0 \\ 0 & 0 & J_1 \end{bmatrix}$$

References

- [1] Singer, Robert A. "*Estimating optimal tracking filter performance for manned maneuvering targets.*" IEEE Transactions on Aerospace and Electronic Systems 4 (1970): 473-483.
- [2] Blackman, Samuel S., and Robert Popoli. "*Design and analysis of modern tracking systems.*" (1999).
- [3] Li, X. Rong, and Vesselin P. Jilkov. "*Survey of maneuvering target tracking: dynamic models.*" Signal and Data Processing of Small Targets 2000, vol. 4048, pp. 212-235. International Society for Optics and Photonics, 2000.

Extended Capabilities

C/C++ Code Generation

Generate C and C++ code using MATLAB® Coder™.

See Also

`initsingerekf` | `singer` | `singerProcessNoise` | `singermeas` | `singermeasjac`

Introduced in R2020b

singermeas

Measurement function for Singer acceleration motion model

Syntax

```
measurements = singermeas(states)
measurements = singermeas(states, frame)
measurements = singermeas(states, frame, sensorpos, sensorvel)
measurements = singermeas(states, frame, sensorpos, sensorvel, laxes)
measurements = singermeas(states, measurementParameters)
```

Description

`measurements = singermeas(states)` returns the measurements in rectangular coordinates for the Singer motion model based on the current states.

`measurements = singermeas(states, frame)` specifies the measurement output coordinate system, `frame`.

`measurements = singermeas(states, frame, sensorpos, sensorvel)` also specifies the sensor position, `sensorpos`, and the sensor velocity, `sensorvel`.

`measurements = singermeas(states, frame, sensorpos, sensorvel, laxes)` specifies the local sensor axes orientation, `laxes`.

`measurements = singermeas(states, measurementParameters)` specifies the measurement parameters, `measurementParameters`.

Examples

Measurements for Singer Model

Define a state for a 2-D Singer acceleration motion.

```
state = [1;10;3;2;20;5];
```

Obtain the measurement in a rectangular frame.

```
measurement = singermeas(state)
```

```
measurement = 3×1
```

```
  1
  2
  0
```

Obtain the measurement in a spherical frame.

```
measurement = singermeas(state, 'spherical')
```

```
measurement = 4×1
63.4349
0
2.2361
22.3607
```

Obtain the measurement in a spherical frame relative to a stationary sensor located at [1;-2;0].

```
measurement = singermeas(state, 'spherical', [1;-2;0], [0;0;0])
measurement = 4×1
```

```
90
0
4
20
```

Obtain the measurement in a spherical frame relative to a stationary sensor located at [1;-2;0] that is rotated by 90 degrees around the z axis relative to the global frame.

```
laxes = [0 -1 0; 1 0 0; 0 0 1];
measurement = singermeas(state, 'spherical', [1;-2;0], [0;0;0], laxes)
```

```
measurement = 4×1
0
0
4
20
```

Obtain measurements from multiple 2D states in a rectangular frame.

```
states = [1 2 3; 10 20 30; 2 4 5; 20 30 40; 5 6 11; 1 3 1.5];
measurements = singermeas(states)
```

```
measurements = 3×3
1    2    3
20   30   40
0    0    0
```

Input Arguments

states — Current states

real-valued $3N$ -by-1 vector | real-valued $3N$ -by- M matrix

Current states, specified as a real-valued $3N$ -by-1 vector or a real-valued $3N$ -by- M matrix. N is the spatial degree of the state, and M is the number of states.

The state vector in each column takes different forms based on its spatial dimensions.

Spatial Degrees	State Vector Structure
1-D	[x;vx;ax]
2-D	[x;vx;ax;y;vy;ay]
3-D	[x;vx;ax;y;vy;ay;z;vz;az]

For example, x represents the x -coordinate, v_x represents the velocity in the x -direction, and a_x represents the acceleration in the x -direction. If the motion model is in one-dimensional space, the y - and z -axes are assumed to be zero. If the motion model is in two-dimensional space, values along the z -axis are assumed to be zero. Position coordinates are in meters. Velocity coordinates are in meters/second. Acceleration coordinates are in m/s^2 .

Example: [5;0.1;0.01;0;-0.2;-0.01;-3;0.05;0]

frame — Measurement output frame

'rectangular' (default) | 'spherical'

Measurement output frame, specified as 'rectangular' or 'spherical'. When the frame is 'rectangular', a measurement consists of x , y , and z Cartesian coordinates. When specified as 'spherical', a measurement consists of azimuth, elevation, range, and range rate.

Data Types: char

sensorpos — Sensor position

[0;0;0] (default) | real-valued 3-by-1 column vector

Sensor position with respect to the navigation frame, specified as a real-valued 3-by-1 column vector. Units are in meters.

Data Types: double

sensorvel — Sensor velocity

[0;0;0] (default) | real-valued 3-by-1 column vector

Sensor velocity with respect to the navigation frame, specified as a real-valued 3-by-1 column vector. Units are in m/s .

Data Types: double

laxes — Local sensor coordinate axes

[1,0,0;0,1,0;0,0,1] (default) | 3-by-3 orthogonal matrix

Local sensor coordinate axes, specified as a 3-by-3 orthogonal matrix. Each column specifies the direction of the local x -, y -, and z -axes, respectively, with respect to the navigation frame. That is, the matrix is the rotation matrix from the global frame to the sensor frame.

Data Types: double

measurementParameters — Measurement parameters

structure | array of structure

Measurement parameters, specified as a structure or an array of structures. For more details, see "Measurement Parameters" on page 1-409.

Data Types: struct

Output Arguments

measurements — Measurements

N-by-1 column vector of scalar | *N*-by-*M* matrix of scalar

Measurement vector, returned as an *N*-by-1 column vector of scalars or an *N*-by-*M* matrix of scalars. The form of the measurement depends upon which syntax you use.

- When the syntax does not use the `measurementParameters` argument, the measurement vector is `[x,y,z]` when the `frame` input argument is set to `'rectangular'` and `[az;el;r;rr]` when the `frame` is set to `'spherical'`.
- When the syntax uses the `measurementParameters` argument, the size of the measurement vector depends on the values of the `Frame`, `HasVelocity`, and `HasElevation` fields in the `measurementParameters` structure.

Frame	Measurement															
'spherical'	<p>Specifies the azimuth angle, <code>az</code>, elevation angle, <code>el</code>, range, <code>r</code>, and range rate, <code>rr</code> of the measurements.</p> <p>Spherical Measurements</p> <table border="1"> <thead> <tr> <th></th> <th></th> <th colspan="2">HasElevation</th> </tr> </thead> <tbody> <tr> <td></td> <td></td> <td>false</td> <td>true</td> </tr> <tr> <td rowspan="2">HasVelocity</td> <td>false</td> <td>[az;r]</td> <td>[az;el;r]</td> </tr> <tr> <td>true</td> <td>[az;r;rr]</td> <td>[az;el;r;rr]</td> </tr> </tbody> </table> <p>Angle units are in degrees, range units are in meters, and range rate units are in m/s.</p>			HasElevation				false	true	HasVelocity	false	[az;r]	[az;el;r]	true	[az;r;rr]	[az;el;r;rr]
		HasElevation														
		false	true													
HasVelocity	false	[az;r]	[az;el;r]													
	true	[az;r;rr]	[az;el;r;rr]													
'rectangular'	<p>Specifies the Cartesian position and velocity coordinates of the measurements.</p> <p>Rectangular Measurements</p> <table border="1"> <thead> <tr> <th>HasVelocity</th> <th></th> <th></th> </tr> </thead> <tbody> <tr> <td>false</td> <td></td> <td>[x;y;z]</td> </tr> <tr> <td>true</td> <td></td> <td>[x;y;z;vx;vy;vz]</td> </tr> </tbody> </table> <p>Position units are in meters and velocity units are in m/s.</p>	HasVelocity			false		[x;y;z]	true		[x;y;z;vx;vy;vz]						
HasVelocity																
false		[x;y;z]														
true		[x;y;z;vx;vy;vz]														

Data Types: `double`

More About

Azimuth and Elevation Angle Definitions

Define the azimuth and elevation angles used in the toolbox.

The azimuth angle of a vector is the angle between the x -axis and its orthogonal projection onto the xy plane. The angle is positive in going from the x axis toward the y axis. Azimuth angles lie between -180 and 180 degrees. The elevation angle is the angle between the vector and its orthogonal projection onto the xy -plane. The angle is positive when going toward the positive z -axis from the xy plane.

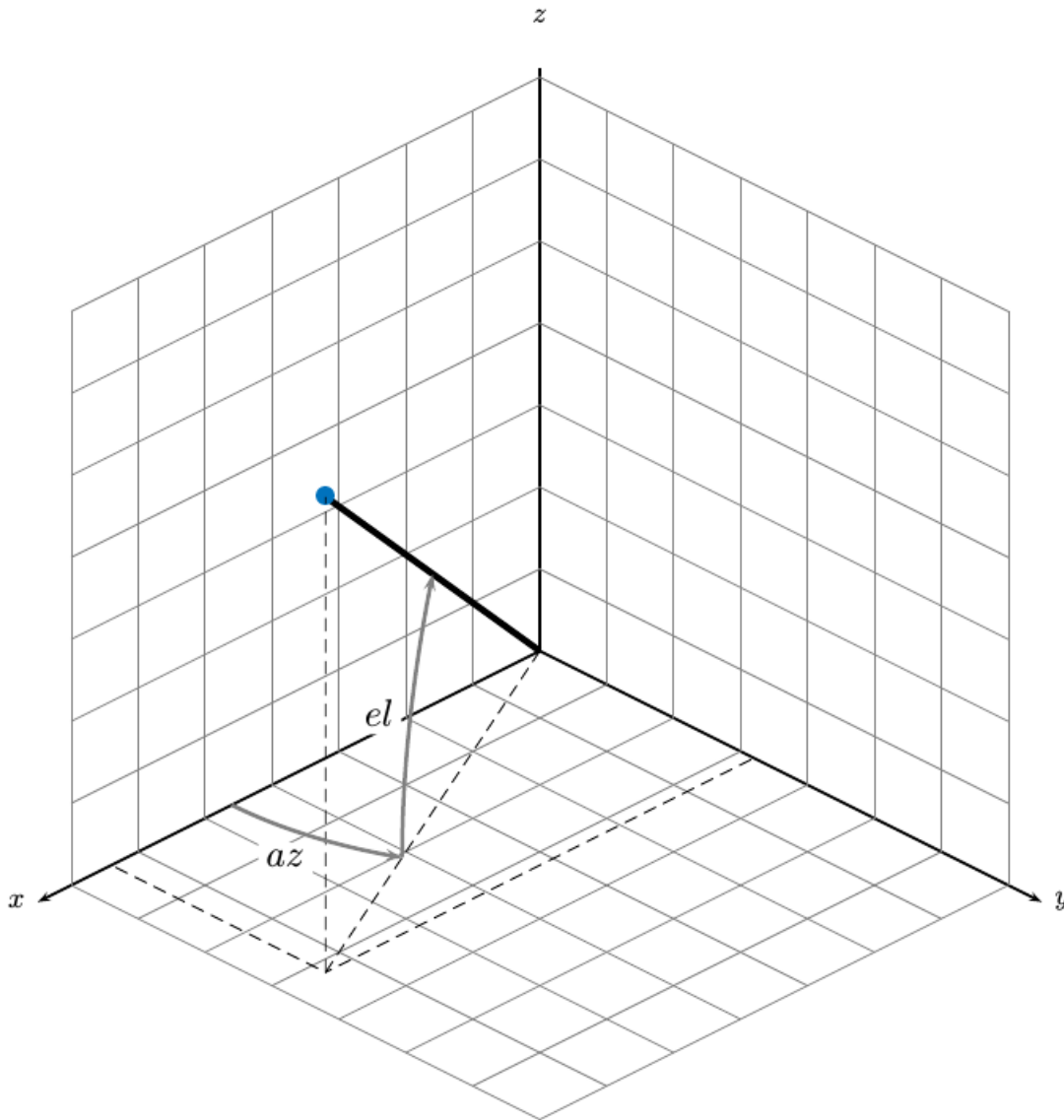

Measurement Parameters

The `MeasurementParameters` property consists of an array of structures that describe a sequence of coordinate transformations from a child frame to a parent frame or the inverse transformations (see “Frame Rotation”). If `MeasurementParameters` only contains one structure, then it represents the rotation from one frame to the other. If `MeasurementParameters` contains an array of structures, then it represents rotations between multiple frames.

The fields of `MeasurementParameters` are shown here. Not all fields have to be present in the structure.

Field	Description
Frame	Enumerated type indicating the frame used to report measurements. When detections are reported using a rectangular coordinate system, <code>Frame</code> is set to 'rectangular'. When detections are reported in spherical coordinates, <code>Frame</code> is set 'spherical' for the first <code>struct</code> .
OriginPosition	Position offset of the origin of the child frame relative to the parent frame, represented as a 3-by-1 vector.
OriginVelocity	Velocity offset of the origin of the child frame relative to the parent frame, represented as a 3-by-1 vector.
Orientation	3-by-3 real-valued orthonormal frame rotation matrix. The direction of the rotation depends on the <code>IsParentToChild</code> field.
IsParentToChild	A logical scalar indicating if <code>Orientation</code> performs a frame rotation from the parent coordinate frame to the child coordinate frame. If <code>false</code> , <code>Orientation</code> performs a frame rotation from the child coordinate frame to the parent coordinate frame.
HasElevation	A logical scalar indicating if elevation is included in the measurement. For measurements reported in a rectangular frame, and if <code>HasElevation</code> is <code>false</code> , the measurements are reported assuming 0 degrees of elevation.
HasAzimuth	A logical scalar indicating if azimuth is included in the measurement.
HasRange	A logical scalar indicating if range is included in the measurement.
HasVelocity	A logical scalar indicating if the reported detections include velocity measurements. For measurements reported in the rectangular frame, if <code>HasVelocity</code> is <code>false</code> , the measurements are reported as <code>[x y z]</code> . If <code>HasVelocity</code> is <code>true</code> , measurements are reported as <code>[x y z vx vy vz]</code> .

References

- [1] Singer, Robert A. "Estimating optimal tracking filter performance for manned maneuvering targets." *IEEE Transactions on Aerospace and Electronic Systems* 4 (1970): 473-483.
- [2] Blackman, Samuel S., and Robert Popoli. "Design and analysis of modern tracking systems." (1999).

- [3] Li, X. Rong, and Vesselin P. Jilkov. "*Survey of maneuvering target tracking: dynamic models.*" Signal and Data Processing of Small Targets 2000, vol. 4048, pp. 212-235. International Society for Optics and Photonics, 2000.

Extended Capabilities

C/C++ Code Generation

Generate C and C++ code using MATLAB® Coder™.

See Also

`initsingerekf` | `singer` | `singerProcessNoise` | `singerjac` | `singermeasjac`

Introduced in R2020b

singermeasjac

Jacobian of measurement function for Singer acceleration motion model

Syntax

```
jacobian = singermeasjac(state)
jacobian = singermeasjac(state, frame)
jacobian = singermeasjac(state, frame, sensorpos, sensorvel)
jacobian = singermeasjac(state, frame, sensorpos, sensorvel, laxes)
jacobian = singermeasjac(state, measurementParameters)
```

Description

`jacobian = singermeasjac(state)` returns the measurement Jacobian in rectangular coordinates with respect to the `state` for the Singer acceleration motion model.

`jacobian = singermeasjac(state, frame)` specifies the measurement Jacobian output coordinate system, `frame`.

`jacobian = singermeasjac(state, frame, sensorpos, sensorvel)` specifies the sensor position, `sensorpos`, and the sensor velocity, `sensorvel`.

`jacobian = singermeasjac(state, frame, sensorpos, sensorvel, laxes)` specifies the local sensor axes orientation, `laxes`.

`jacobian = singermeasjac(state, measurementParameters)` specifies the measurement parameters, `measurementParameters`.

Examples

Obtain Measurement Jacobian Matrix of Singer Model

Define a state for 2-D Singer acceleration motion.

```
state = [1;10;0;2;20;1];
```

Obtain the measurement Jacobian in a rectangular frame.

```
jacobian = singermeasjac(state)
```

```
jacobian = 3×6
```

```
    1    0    0    0    0    0
    0    0    0    1    0    0
    0    0    0    0    0    0
```

Obtain the measurement Jacobian in a spherical frame.

```
jacobian = singermeasjac(state, 'spherical')
```

```
jacobian = 4×6
```

```
-22.9183      0      0      11.4592      0      0
      0      0      0      0      0      0
      0.4472    0      0      0.8944      0      0
      0.0000    0.4472    0      0.0000    0.8944      0
```

Obtain the measurement Jacobian in a spherical frame relative to a stationary sensor located at [1;-2;0].

```
jacobian = singermeasjac(state, 'spherical', [1;-2;0], [0;0;0])
```

```
jacobian = 4×6
```

```
-14.3239      0      0      0      0      0
      0      0      0      0      0      0
      0      0      0      1.0000    0      0
      2.5000    0      0      0      1.0000    0
```

Obtain the measurement Jacobian in a spherical frame relative to a stationary sensor located at [1;-2;0] that is rotated by 90 degrees around the z axis relative to the global frame.

```
laxes = [0 -1 0; 1 0 0; 0 0 1];
```

```
jacobian = singermeasjac(state, 'spherical', [1;-2;0], [0;0;0], laxes)
```

```
jacobian = 4×6
```

```
-14.3239      0      0      0      0      0
      0      0      0      0      0      0
      0      0      0      1.0000    0      0
      2.5000    0      0      0      1.0000    0
```

Input Arguments

state — Current state

real-valued $3N$ -by-1 vector

Current state, specified as a real-valued $3N$ -by-1 vector. N is the spatial degree of the state. The state vector takes the different forms based on its dimensions.

Spatial Degrees	State Vector Structure
1-D	[x;vx;ax]
2-D	[x;vx;ax;y;vy;ay]
3-D	[x;vx;ax;y;vy;ay;z;vz;az]

For example, x represents the x -coordinate, v_x represents the velocity in the x -direction, and a_x represents the acceleration in the x -direction. If the motion model is in one-dimensional space, the y - and z -axes are assumed to be zero. If the motion model is in two-dimensional space, values along the z -axis are assumed to be zero. Position coordinates are in meters. Velocity coordinates are in m/s. Acceleration coordinates are in m/s^2 .

Example: [5;0.1;0.01;0;-0.2;-0.01;-3;0.05;0]

frame — Measurement output frame

'rectangular' (default) | 'spherical'

Measurement output frame, specified as 'rectangular' or 'spherical'. When the frame is 'rectangular', a measurement consists of x , y , and z Cartesian coordinates. When specified as 'spherical', a measurement consists of azimuth, elevation, range, and range rate.

Data Types: char

sensorpos — Sensor position

[0;0;0] (default) | real-valued 3-by-1 column vector

Sensor position with respect to the navigation frame, specified as a real-valued 3-by-1 column vector. Units are in meters.

Data Types: double

sensorvel — Sensor velocity

[0;0;0] (default) | real-valued 3-by-1 column vector

Sensor velocity with respect to the navigation frame, specified as a real-valued 3-by-1 column vector. Units are in m/s.

Data Types: double

laxes — Local sensor coordinate axes

[1,0,0;0,1,0;0,0,1] (default) | 3-by-3 orthogonal matrix

Local sensor coordinate axes, specified as a 3-by-3 orthogonal matrix. Each column specifies the direction of the local x -, y -, and z -axes, respectively, with respect to the navigation frame. That is, the matrix is the rotation matrix from the global frame to the sensor frame.

Data Types: double

measurementParameters — Measurement parameters

structure | array of structure

Measurement parameters, specified as a structure or an array of structures. For more details, see "Measurement Parameters" on page 1-416.

Data Types: struct

Output Arguments**jacobian — Measurement Jacobian**real-valued 3-by- N matrix | real-valued 4-by- N matrix

The measurement Jacobian for a Singer model, returned as a real-valued 3-by- N for a rectangular frame or 4-by- N matrix for a spherical frame. N is the dimension of the state vector. The interpretation of the rows and columns depends on the `frame` argument, as described in this table.

Frame	Measurement Jacobian
'rectangular'	Jacobian of the measurements $[x; y; z]$ with respect to the state vector. Coordinates are in meters.

Frame	Measurement Jacobian
'spherical'	Jacobian of the measurement vector $[az; el; r; rr]$ with respect to the state vector. Measurement vector is the azimuth angle, elevation angle, range, and range rate of the object in the local sensor coordinate system. Angle units are in degrees. Range units are in meters and range rate units are in ms/s.

More About

Azimuth and Elevation Angle Definitions

Define the azimuth and elevation angles used in the toolbox.

The azimuth angle of a vector is the angle between the x -axis and its orthogonal projection onto the xy plane. The angle is positive in going from the x axis toward the y axis. Azimuth angles lie between -180 and 180 degrees. The elevation angle is the angle between the vector and its orthogonal projection onto the xy -plane. The angle is positive when going toward the positive z -axis from the xy plane.

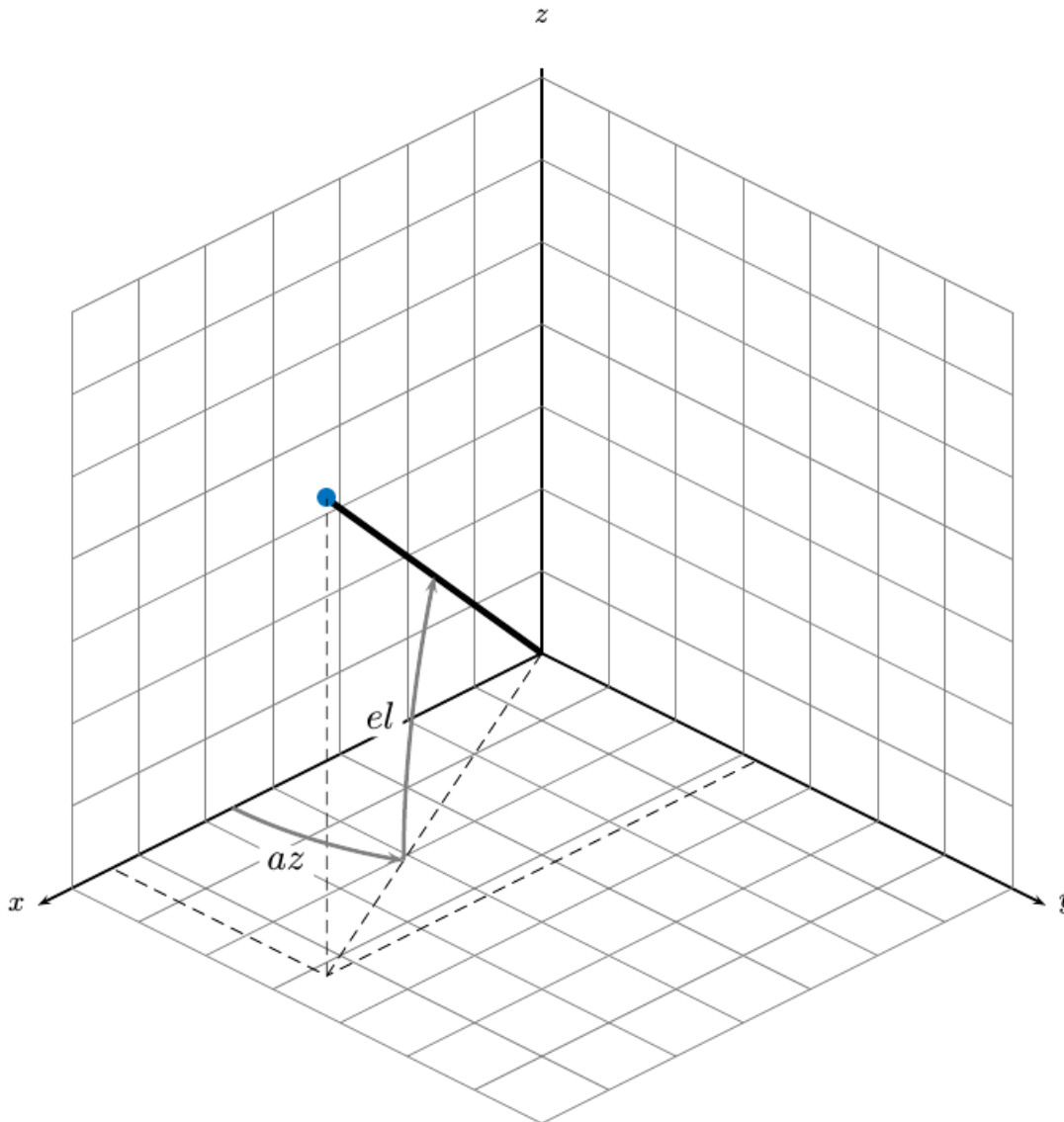

Measurement Parameters

The `MeasurementParameters` property consists of an array of structures that describe a sequence of coordinate transformations from a child frame to a parent frame or the inverse transformations (see “Frame Rotation”). If `MeasurementParameters` only contains one structure, then it represents the rotation from one frame to the other. If `MeasurementParameters` contains an array of structures, then it represents rotations between multiple frames.

The fields of `MeasurementParameters` are shown here. Not all fields have to be present in the structure.

Field	Description
-------	-------------

Frame	Enumerated type indicating the frame used to report measurements. When detections are reported using a rectangular coordinate system, Frame is set to 'rectangular'. When detections are reported in spherical coordinates, Frame is set to 'spherical' for the first struct.
OriginPosition	Position offset of the origin of the child frame relative to the parent frame, represented as a 3-by-1 vector.
OriginVelocity	Velocity offset of the origin of the child frame relative to the parent frame, represented as a 3-by-1 vector.
Orientation	3-by-3 real-valued orthonormal frame rotation matrix. The direction of the rotation depends on the IsParentToChild field.
IsParentToChild	A logical scalar indicating if Orientation performs a frame rotation from the parent coordinate frame to the child coordinate frame. If false, Orientation performs a frame rotation from the child coordinate frame to the parent coordinate frame.
HasElevation	A logical scalar indicating if elevation is included in the measurement. For measurements reported in a rectangular frame, and if HasElevation is false, the measurements are reported assuming 0 degrees of elevation.
HasAzimuth	A logical scalar indicating if azimuth is included in the measurement.
HasRange	A logical scalar indicating if range is included in the measurement.
HasVelocity	A logical scalar indicating if the reported detections include velocity measurements. For measurements reported in the rectangular frame, if HasVelocity is false, the measurements are reported as [x y z]. If HasVelocity is true, measurements are reported as [x y z vx vy vz].

References

- [1] Singer, Robert A. "Estimating optimal tracking filter performance for manned maneuvering targets." IEEE Transactions on Aerospace and Electronic Systems 4 (1970): 473-483.
- [2] Blackman, Samuel S., and Robert Popoli. "Design and analysis of modern tracking systems." (1999).

[3] Li, X. Rong, and Vesselin P. Jilkov. "*Survey of maneuvering target tracking: dynamic models.*" Signal and Data Processing of Small Targets 2000, vol. 4048, pp. 212-235. International Society for Optics and Photonics, 2000.

Extended Capabilities

C/C++ Code Generation

Generate C and C++ code using MATLAB® Coder™.

See Also

`initsingerekf` | `singer` | `singerProcessNoise` | `singerjac` | `singermeas`

Introduced in R2020b

singerProcessNoise

Process noise matrix for Singer acceleration model

Syntax

```
processNoise = singerProcessNoise(state)
processNoise = singerProcessNoise(state,dt)
processNoise = singerProcessNoise(state,dt,tau)
processNoise = singerProcessNoise(state,dt,tau,sigma)
```

Description

`processNoise = singerProcessNoise(state)` returns the process noise matrix for the Singer acceleration model based on the current state. For more details, see Reference [3].

`processNoise = singerProcessNoise(state,dt)` specifies the time step `dt`. The default time step is 1 second.

`processNoise = singerProcessNoise(state,dt,tau)` specifies the target maneuver time constant `tau`. The default maneuver time constant is 20 seconds.

`processNoise = singerProcessNoise(state,dt,tau,sigma)` specifies the target maneuver standard deviation `sigma`. The default maneuver standard deviation is 1 meter per second squared.

Examples

Process Noise Matrix for Singer Acceleration Model

Obtain the Singer process noise for a 3-D Singer state that has a default time step, a target maneuver time constant, and a standard deviation.

```
Q1 = singerProcessNoise((1:9)')
```

```
Q1 = 9×9
```

```

0.0049    0.0121    0.0159         0         0         0         0         0         0
0.0121    0.0321    0.0476         0         0         0         0         0         0
0.0159    0.0476    0.0952         0         0         0         0         0         0
         0         0         0    0.0049    0.0121    0.0159         0         0         0
         0         0         0    0.0121    0.0321    0.0476         0         0         0
         0         0         0    0.0159    0.0476    0.0952         0         0         0
         0         0         0         0         0         0    0.0049    0.0121    0.0159
         0         0         0         0         0         0    0.0121    0.0321    0.0476
         0         0         0         0         0         0    0.0159    0.0476    0.0952
```

Set the time step as 2 seconds. Set the target maneuver time constant as 10 seconds in x- and y- axes and as 100 seconds in z-axis. Set the target maneuver standard deviation as 1m/s^2 in x- and y- axes and 0 m/s^2 in z-axis.

```
Q2 = singerProcessNoise((1:9)', 2, [10 10 100], [1 1 0])
```

```
Q2 = 9×9
```

```

0.2868    0.3508    0.2188         0         0         0         0         0
0.3508    0.4603    0.3286         0         0         0         0         0
0.2188    0.3286    0.3297         0         0         0         0         0
         0         0         0    0.2868    0.3508    0.2188         0         0
         0         0         0    0.3508    0.4603    0.3286         0         0
         0         0         0    0.2188    0.3286    0.3297         0         0
         0         0         0         0         0         0         0         0
         0         0         0         0         0         0         0         0
         0         0         0         0         0         0         0         0

```

Input Arguments

state — Current state

real-valued $3N$ -by-1 vector

Current state, specified as a real-valued $3N$ -by-1 vector. N is the spatial degree of the state. The state vector takes the different forms based on its dimensions.

Spatial Degrees	State Vector Structure
1-D	[x; vx; ax]
2-D	[x; vx; ax; y; vy; ay]
3-D	[x; vx; ax; y; vy; ay; z; vz; az]

For example, x represents the x -coordinate, vx represents the velocity in the x -direction, and ax represents the acceleration in the x -direction. If the motion model is in one-dimensional space, the y - and z -axes are assumed to be zero. If the motion model is in two-dimensional space, values along the z -axis are assumed to be zero. Position coordinates are in meters. Velocity coordinates are in m/s. Acceleration coordinates are in m/s^2 .

Example: [5;0.1;0.01;0;-0.2;-0.01;-3;0.05;0]

dt — Time step

1.0 (default) | positive scalar

Time step, specified as a positive scalar in seconds.

Example: 0.5

tau — Target maneuver time constant

20 (default) | positive scalar | N -element vector of scalar

Target maneuver time constant, specified as a positive scalar or an N -element vector of scalars in seconds. N is the spatial degree of the state. When specified as a vector, each element applies to the corresponding spatial dimension.

Example: 30

sigma — Maneuver standard deviation

1 (default) | positive scalar | N -element vector of scalar

Maneuver standard deviation, specified as a positive scalar or an N -element vector of scalars in m/s^2 . N is the spatial degree of the state. When specified as a vector, each element applies to the corresponding spatial dimension.

Example: 3

Output Arguments

processNoise — Process noise for Singer acceleration model

N -by- N matrix of nonnegative scalars

Process noise for a Singer acceleration model, returned as an N -by- N matrix of nonnegative scalars. N is the spatial dimension of the `state` input.

References

- [1] Singer, Robert A. "Estimating optimal tracking filter performance for manned maneuvering targets." IEEE Transactions on Aerospace and Electronic Systems 4 (1970): 473-483.
- [2] Blackman, Samuel S., and Robert Popoli. "Design and analysis of modern tracking systems." (1999).
- [3] Li, X. Rong, and Vesselin P. Jilkov. "Survey of maneuvering target tracking: dynamic models." Signal and Data Processing of Small Targets 2000, vol. 4048, pp. 212-235. International Society for Optics and Photonics, 2000.

Extended Capabilities

C/C++ Code Generation

Generate C and C++ code using MATLAB® Coder™.

See Also

`initsingerekf` | `singer` | `singerjac` | `singermeas` | `singermeasjac`

Introduced in R2020b

tunerPlotPose

Plot filter pose estimates during tuning

Syntax

```
stopTuning = tunerPlotPose(params,tunerValues)
```

Description

`stopTuning = tunerPlotPose(params,tunerValues)` plots the current pose estimate, consisting of orientation (and possibly position, depending on the filter), and the ground truth values. `params` contains the best estimates of the filter parameters during the current tuning iteration. `tunerValues` contains information on the tuner configuration, sensor data, and ground truth data. Use this function as the value for the `OutputFcn` property of the `tunerconfig` object to plot the tuning results during iterations.

Examples

Visualize Tuning Results Using tunerPlotPose

Create a `tunerconfiguration` object. Set the `tunerPlotPose` function as the output function of the object.

```
tc = tunerconfig('imufilter','OutputFcn',@tunerPlotPose)
```

```
tc =
  tunerconfig with properties:
          Filter: "imufilter"
  TunableParameters: [1x5 string]
      StepForward: 1.1000
      StepBackward: 0.5000
      MaxIterations: 20
      ObjectiveLimit: 0.1000
      FunctionTolerance: 0
          Display: iter
              Cost: RMS
      OutputFcn: @tunerPlotPose
```

Load prerecorded sensor data.

```
ld = load('imufilterTuneData.mat');
```

Tune an `imufilter` object using the sensor data. The truth data and the estimates are shown in a figure.

```
tune(imufilter,ld.sensorData,ld.groundTruth,tc)
```

Iteration	Parameter	Metric
_____	_____	_____

1	AccelerometerNoise	0.1149
1	GyroscopeNoise	0.1146
1	GyroscopeDriftNoise	0.1146
1	LinearAccelerationNoise	0.1122
1	LinearAccelerationDecayFactor	0.1103
2	AccelerometerNoise	0.1102
2	GyroscopeNoise	0.1098
2	GyroscopeDriftNoise	0.1098
2	LinearAccelerationNoise	0.1070
2	LinearAccelerationDecayFactor	0.1053
3	AccelerometerNoise	0.1053
3	GyroscopeNoise	0.1048
3	GyroscopeDriftNoise	0.1048
3	LinearAccelerationNoise	0.1016
3	LinearAccelerationDecayFactor	0.1002
4	AccelerometerNoise	0.1001
4	GyroscopeNoise	0.0996

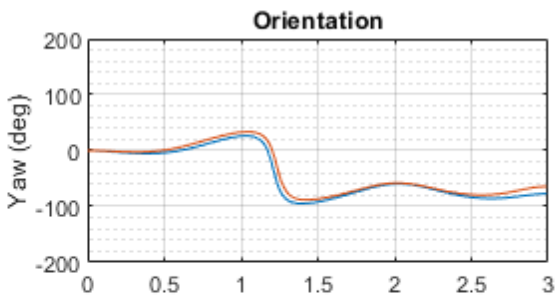

Iteration: 4
RMS Orientation Error (deg): 5.7042

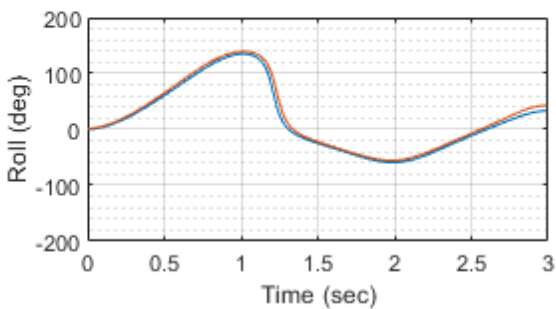
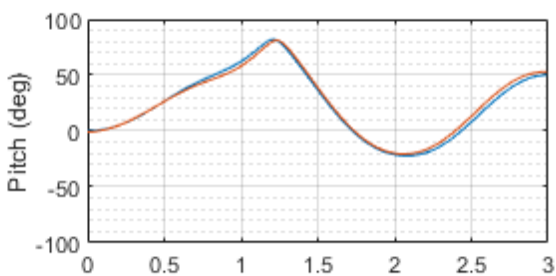

Input Arguments

params — Estimates of filter parameters

structure

Estimates of filter parameters during the current iteration of the tuning process, specified as a structure. The structure contains one field for every public property of the filter and additional fields for any required measurement noise. The exact field names vary depending on the filter being tuned.

tunerValues — Tuner values

structure

Tuner values, specified as a structure. The structure has these fields:

Field Name	Description
Iteration	Iteration count of the tuner, specified as a positive integer
SensorData	Sensor data input to the tune function
GroundTruth	Ground truth input to the tune function
Configuration	tunerconfig object used for tuning
Cost	Tuning cost at the end of the current iteration

Output Arguments

stopTuning — Stop tuning process

false

Stop the tuning process, returned as false. As a result, using the tunerPlotPose function as the output function of a tunerconfig object never terminates the tuning process of a fusion filter.

See Also

ahrs10filter | ahrsfilter | imufilter | insfilterAsync | insfilterErrorState | insfilterMARG | insfilterNonholonomic | tunerconfig | tunernoise

Introduced in R2021a

assignauction

Assignment using auction global nearest neighbor

Syntax

```
[assignments,unassignedrows,unassignedcolumns] = assignauction(costmatrix,
costofnonassignment)
```

Description

[assignments,unassignedrows,unassignedcolumns] = assignauction(costmatrix, costofnonassignment) returns a table of assignments of detections to tracks derived based on the forward/reverse auction algorithm. The auction algorithm finds a suboptimal solution to the global nearest neighbor (GNN) assignment problem by minimizing the total cost of assignment. While suboptimal, the auction algorithm is faster than the Munkres algorithm for large GNN assignment problems, for example, when there are more than 50 rows and columns in the cost matrix.

The cost of each potential assignment is contained in the cost matrix, `costmatrix`. Each matrix entry represents the cost of a possible assignments. Matrix rows represent tracks and columns represent detections. All possible assignments are represented in the cost matrix. The lower the cost, the more likely the assignment is to be made. Each track can be assigned to at most one detection and each detection can be assigned to at most one track. If the number of rows is greater than the number of columns, some tracks are unassigned. If the number of columns is greater than the number of rows, some detections are unassigned. You can set an entry of `costmatrix` to `Inf` to prohibit an assignment.

`costofnonassignment` represents the cost of leaving tracks or detections unassigned. Higher values increase the likelihood that every existing object is assigned.

The function returns a list of unassigned tracks, `unassignedrows`, and a list of unassigned detections, `unassignedcolumns`.

Examples

Assign Detections to Tracks Using Auction Algorithm

Use `assignAuction` to assign three detections to two tracks.

Start with two predicted track locations in x-y coordinates.

```
tracks = [1,1; 2,2];
```

Assume three detections are received. At least one detection will not be assigned.

```
dets = [1.1, 1.1; 2.1, 2.1; 1.5, 3];
```

Construct a cost matrix by defining the cost of assigning a detection to a track as the Euclidean distance between them. Set the cost of non-assignment to 0.2.

```
for i = size(tracks, 1):-1:1
    delta = dets - tracks(i, :);
    costMatrix(i, :) = sqrt(sum(delta .^ 2, 2));
end
costofnonassignment = 0.2;
```

Use the Auction algorithm to assign detections to tracks.

```
[assignments, unassignedTracks, unassignedDetections] = ...
    assignauction(costMatrix, costofnonassignment);
```

Display the assignments.

```
disp(assignments)
```

```
 1  1
 2  2
```

Show that there are no unassigned tracks.

```
disp(unassignedTracks)
```

Display the unassigned detections.

```
disp(unassignedDetections)
```

```
 3
```

Plot detection to track assignments.

```
plot(tracks(:, 1), tracks(:, 2), '*', dets(:, 1), dets(:, 2), 'o')
hold on
xlim([0, 4])
ylim([0, 4])
legend('tracks', 'detections')
assignStr = strsplit(num2str(1:size(assignments,1)));
text(tracks(assignments(:, 1),1) + 0.1, ...
     tracks(assignments(:, 1),2) - 0.1, assignStr);
text(dets(assignments(:, 2),1) + 0.1, ...
     dets(assignments(:, 2),2) - 0.1, assignStr);
text(dets(unassignedDetections(:,1) + 0.1, ...
         dets(unassignedDetections(:,2) + 0.1, 'unassigned');
```

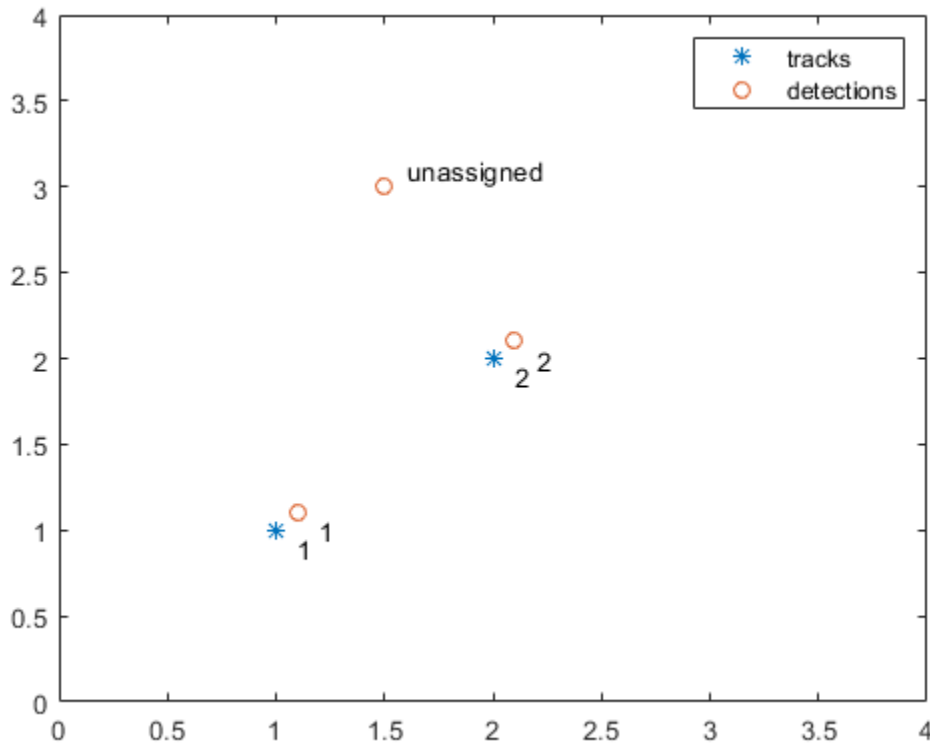

The track to detection assignments are:

- 1 Detection 1 is assigned to track 1.
- 2 Detection 2 is assigned to track 2.
- 3 Detection 3 is not assigned.

Input Arguments

costmatrix — Cost matrix

real-valued M -by- N

Cost matrix, specified as an M -by- N matrix. M is the number of tracks to be assigned and N is the number of detections to be assigned. Each entry in the cost matrix contains the cost of a track and detection assignment. The matrix may contain `Inf` entries to indicate that an assignment is prohibited. The cost matrix cannot be a sparse matrix.

Data Types: `single` | `double`

costofnonassignment — cost of non-assignment of tracks and detections

scalar

Cost of non-assignment, specified as a scalar. The cost of non-assignment represents the cost of leaving tracks or detections unassigned. Higher values increase the likelihood that every object is assigned. The value cannot be set to `Inf`.

Data Types: `single` | `double`

Output Arguments

assignments — Assignment of tracks to detections

integer-valued L -by-2 matrix

Assignment of detections to track, returned as an integer-valued L -by-2 matrix where L is the number of assignments. The first column of the matrix contains the assigned track indices and the second column contains the assigned detection indices.

Data Types: `uint32`

unassignedrows — Indices of unassigned tracks

integer-valued P -by-1 column vector

Indices of unassigned tracks, returned as an integer-valued P -by-1 column vector.

Data Types: `uint32`

unassignedcolumns — Indices of unassigned detections

integer-valued Q -by-1 column vector

Indices of unassigned detections, returned as an integer-valued Q -by-1 column vector.

Data Types: `uint32`

References

[1] Samuel S. Blackman and Popoli, R. *Design and Analysis of Modern Tracking Systems*. Artech House: Norwood, MA. 1999.

Extended Capabilities

C/C++ Code Generation

Generate C and C++ code using MATLAB® Coder™.

See Also

Functions

`assignTOMHT` | `assignjv` | `assignkbest` | `assignkbestsd` | `assignmunkres` | `assignsd` | `trackerGNN` | `trackerTOMHT`

Introduced in R2018b

assignjv

Jonker-Volgenant global nearest neighbor assignment algorithm

Syntax

```
[assignments,unassignedrows,unassignedcolumns] = assignjv(costmatrix,
costofnonassignment)
```

Description

[assignments,unassignedrows,unassignedcolumns] = assignjv(costmatrix, costofnonassignment) returns a table of assignments of detections to tracks using the Jonker-Volgenant algorithm. The JV algorithm finds an optimal solution to the global nearest neighbor (GNN) assignment problem by finding the set of assignments that minimize the total cost of the assignments. The Jonker-Volgenant algorithm solves the GNN assignment in two phases: begin with the auction algorithm and end with the Dijkstra shortest path algorithm.

The cost of each potential assignment is contained in the cost matrix, `costmatrix`. Each matrix entry represents the cost of a possible assignments. Matrix rows represent tracks and columns represent detections. All possible assignments are represented in the cost matrix. The lower the cost, the more likely the assignment is to be made. Each track can be assigned to at most one detection and each detection can be assigned to at most one track. If the number of rows is greater than the number of columns, some tracks are unassigned. If the number of columns is greater than the number of rows, some detections are unassigned. You can set an entry of `costmatrix` to `Inf` to prohibit an assignment.

`costofnonassignment` represents the cost of leaving tracks or detections unassigned. Higher values increase the likelihood that every existing object is assigned.

The function returns a list of unassigned tracks, `unassignedrows`, and a list of unassigned detections, `unassignedcolumns`.

Examples

Assign Detections to Tracks Using Jonker-Volgenant Algorithm

Use `assignjv` to assign three detections to two tracks.

Start with two predicted track locations in x-y coordinates.

```
tracks = [1,1; 2,2];
```

Assume three detections are received. At least one detection will not be assigned.

```
dets = [1.1, 1.1; 2.1, 2.1; 1.5, 3];
```

Construct a cost matrix by defining the cost of assigning a detection to a track as the Euclidean distance between them. Set the cost of non-assignment to 0.2.

```
for i = size(tracks,1):-1:1
    delta = dets - tracks(i,:);
    costMatrix(i,:) = sqrt(sum(delta .^ 2,2));
end
costofnonassignment = 0.2;
```

Use the Auction algorithm to assign detections to tracks.

```
[assignments, unassignedTracks, unassignedDetections] = ...
    assignjv(costMatrix,costofnonassignment);
```

Display the assignments.

```
disp(assignments)
```

```
 1  1
 2  2
```

Show that there are no unassigned tracks.

```
disp(unassignedTracks)
```

Display the unassigned detections.

```
disp(unassignedDetections)
```

```
 3
```

Plot the detection to track assignments.

```
plot(tracks(:, 1), tracks(:, 2), '*', dets(:, 1), dets(:, 2), 'o')
hold on
xlim([0,4])
ylim([0,4])
legend('tracks', 'detections')
assignStr = strsplit(num2str(1:size(assignments,1)));
text(tracks(assignments(:,1),1) + 0.1, ...
     tracks(assignments(:,1),2) - 0.1, assignStr);
text(dets(assignments(:,2),1) + 0.1, ...
     dets(assignments(:,2),2) - 0.1, assignStr);
text(dets(unassignedDetections(:,1)) + 0.1, ...
     dets(unassignedDetections(:,2)) + 0.1, 'unassigned');
```

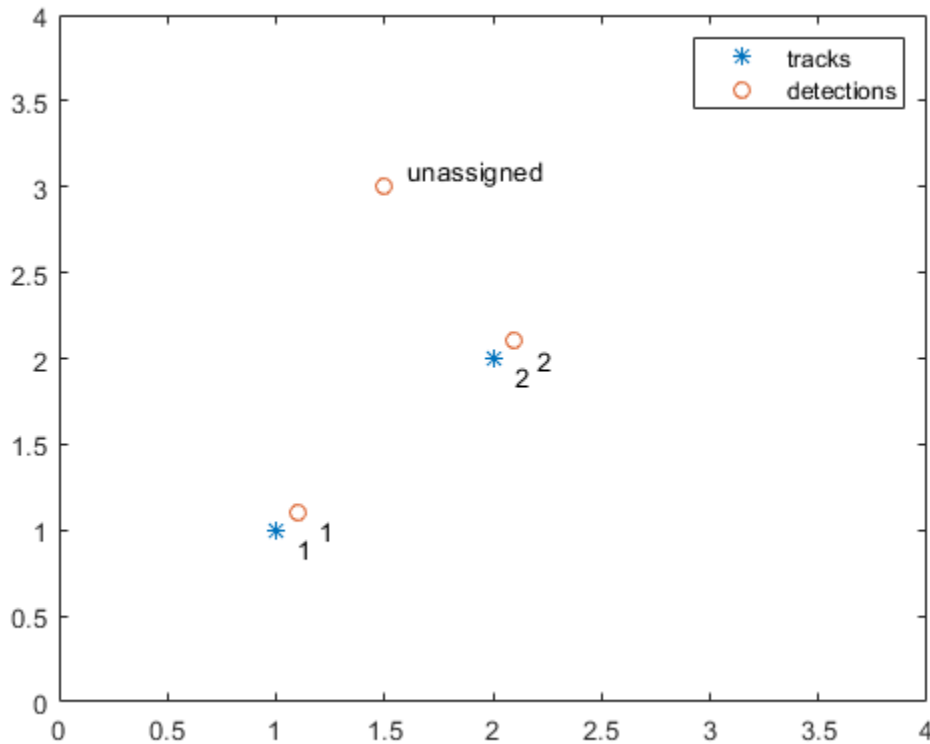

The track to detection assignments are:

- 1 Detection 1 is assigned to track 1.
- 2 Detection 2 is assigned to track 2.
- 3 Detection 3 is not assigned.

Input Arguments

costmatrix — Cost matrix

real-valued M -by- N

Cost matrix, specified as an M -by- N matrix. M is the number of tracks to be assigned and N is the number of detections to be assigned. Each entry in the cost matrix contains the cost of a track and detection assignment. The matrix may contain `Inf` entries to indicate that an assignment is prohibited. The cost matrix cannot be a sparse matrix.

Data Types: `single` | `double`

costofnonassignment — cost of non-assignment of tracks and detections

scalar

Cost of non-assignment, specified as a scalar. The cost of non-assignment represents the cost of leaving tracks or detections unassigned. Higher values increase the likelihood that every object is assigned. The value cannot be set to `Inf`.

Data Types: `single` | `double`

Output Arguments

assignments — Assignment of tracks to detections

integer-valued L -by-2 matrix

Assignment of detections to track, returned as an integer-valued L -by-2 matrix where L is the number of assignments. The first column of the matrix contains the assigned track indices and the second column contains the assigned detection indices.

Data Types: `uint32`

unassignedrows — Indices of unassigned tracks

integer-valued P -by-1 column vector

Indices of unassigned tracks, returned as an integer-valued P -by-1 column vector.

Data Types: `uint32`

unassignedcolumns — Indices of unassigned detections

integer-valued Q -by-1 column vector

Indices of unassigned detections, returned as an integer-valued Q -by-1 column vector.

Data Types: `uint32`

References

[1] Samuel S. Blackman and Popoli, R. *Design and Analysis of Modern Tracking Systems*. Artech House: Norwood, MA. 1999.

Extended Capabilities

C/C++ Code Generation

Generate C and C++ code using MATLAB® Coder™.

See Also

Functions

`assignTOMHT` | `assignauction` | `assignkbest` | `assignkbestsd` | `assignmunkres` | `assignsd` | `trackerGNN` | `trackerTOMHT`

Introduced in R2018b

assignkbest

Assignment using k-best global nearest neighbor

Syntax

```
[assignments,unassignedrows,unassignedcolumns,cost] = assignkbest(costmatrix,
costofnonassignment)
[assignments,unassignedrows,unassignedcolumns,cost] = assignkbest(costmatrix,
costofnonassignment,k)
[assignments,unassignedrows,unassignedcolumns,cost] = assignkbest(costmatrix,
costofnonassignment,k,algorithm)
```

Description

`[assignments,unassignedrows,unassignedcolumns,cost] = assignkbest(costmatrix, costofnonassignment)` returns a table of assignments, `assignments`, of detections to tracks using the Jonker-Volgenant algorithm. The algorithm finds the global nearest neighbor (GNN) solution that minimizes the total cost of the assignments.

The cost of each potential assignment is contained in the cost matrix, `costmatrix`. Each matrix entry represents the cost of a possible assignments. Matrix rows represent tracks and columns represent detections. All possible assignments are represented in the cost matrix. The lower the cost, the more likely the assignment is to be made. Each track can be assigned to at most one detection and each detection can be assigned to at most one track. If the number of rows is greater than the number of columns, some tracks are unassigned. If the number of columns is greater than the number of rows, some detections are unassigned. You can set an entry of `costmatrix` to `Inf` to prohibit an assignment.

`costofnonassignment` represents the cost of leaving tracks or detections unassigned. Higher values increase the likelihood that every existing object is assigned.

All inputs must all be single precision or all be double precision.

The function returns a list of unassigned tracks, `unassignedrows`, a list of unassigned detections, `unassignedcolumns`, and the cost of assignment, `cost`.

`[assignments,unassignedrows,unassignedcolumns,cost] = assignkbest(costmatrix, costofnonassignment,k)` also specifies the number, `k`, of `k`-best global nearest neighbor solutions that minimize the total cost of assignments. In addition to the best solution, the function uses the Murty algorithm to find the remaining `k-1` solutions.

`[assignments,unassignedrows,unassignedcolumns,cost] = assignkbest(costmatrix, costofnonassignment,k,algorithm)` also specifies the algorithm, `algorithm`, for finding the assignments.

Examples

Find Five Best Solutions Using Assignkbest

Create a cost matrix containing prohibited assignments. Then, use the `assignkbest` function to find the 5 best solutions.

Set up the cost matrix to contain some prohibited or invalid assignments by inserting `Inf` into the matrix.

```
costMatrix = [10 5 8 9; 7 Inf 20 Inf; Inf 21 Inf Inf; Inf 15 17 Inf; Inf inf 16 22];  
costOfNonAssignment = 100;
```

Find the 5 best assignments.

```
[assignments,unassignedrows,unassignedcols,cost] = ...  
    assignkbest(costMatrix,costOfNonAssignment,5)
```

```
assignments=5×1 cell array  
    {4×2 uint32}  
    {4×2 uint32}  
    {4×2 uint32}  
    {4×2 uint32}  
    {4×2 uint32}
```

```
unassignedrows=5×1 cell array  
    {[3]}  
    {[3]}  
    {[3]}  
    {[4]}  
    {[5]}
```

```
unassignedcols=5×1 cell array  
    {0×1 uint32}  
    {0×1 uint32}  
    {0×1 uint32}  
    {0×1 uint32}  
    {0×1 uint32}
```

```
cost = 5×1
```

```
147  
151  
152  
153  
154
```

Input Arguments

costmatrix — Cost matrix

real-valued M -by- N

Cost matrix, specified as an M -by- N matrix. M is the number of tracks to be assigned and N is the number of detections to be assigned. Each entry in the cost matrix contains the cost of a track and

detection assignment. The matrix may contain `Inf` entries to indicate that an assignment is prohibited. The cost matrix cannot be a sparse matrix.

Data Types: `single` | `double`

costofnonassignment — cost of non-assignment of tracks and detections

scalar | two-element vector of scalars | two-element cell array of vectors

Cost of non-assignment, specified as a scalar, a two-element vector of scalars, or a two-element cell array of vectors.

- When specified as a scalar, it represents the cost of leaving tracks or detections unassigned. Higher values increase the likelihood that every object is assigned. The value cannot be set to `Inf`.
- When specified as a two-element scalars, the first element represents the cost of leaving detections unassigned and the second element represents the cost of leaving tracks unassigned.
- When specified as a two-element cell of vectors, each element in the first vector represents the cost of leaving the specific detection unassigned and each element of the second vector represents the cost of leaving the specific track unassigned. The length of the first vector is equal to the number of detections and the length of the second vector is equal to the number of tracks.

Data Types: `single` | `double`

k — Number of best solutions

positive integer

Number of best solutions, specified as a positive integer.

Data Types: `single` | `double`

algorithm — Assignment algorithm

'jv' (default) | 'munkres' | 'auction' | 'matchpair'

Assignment algorithm, specified as 'jv' for the Jonker-Volgenant algorithm, 'munkres' for the Munkres algorithm, 'auction' for the Auction algorithm, or 'matchpair' for the match pair algorithm. When 'jv' is selected, the function uses heuristics defined in [3] to improve the algorithm performance.

Example: 'jv'

Data Types: `char` | `string`

Output Arguments

assignments — Assignment of tracks to detections

k-element cell array

Assignment of tracks to detections, returned as a *k*-element cell array. *k* is the number of best solutions. Each cell contains an L_i -by-2 matrix of pairs of track indices and assigned detection indices. L_i is the number of assignment pairs in the i^{th} solution cell. The first column of each matrix contains the track indices and the second column contains the assigned detection indices.

unassignedrows — Indices of unassigned tracks

k-element cell array

Indices of unassigned tracks, returned as a k -element cell array. Each cell is a P_i vector where $P_i = M - L_i$ is the number of unassigned rows in the i^{th} cell. Each element is the index of a row to which no columns are assigned. k is the number of best solutions.

Data Types: `uint32`

unassignedcolumns — Indices of unassigned detections

k -element cell array

Indices of unassigned detections, returned as a k -element cell array. Each cell is a Q_i vector where $Q_i = M - L_i$ is the number of unassigned detections in the i^{th} cell. Each element is the index of a column to which no rows are assigned. k is the number of best solutions.

Data Types: `uint32`

cost — Total cost of solutions

k -element vector (default)

Total cost of solutions, returned as a k -element vector. Each element is a scalar value summarizing the total cost of the solution to the assignment problem.

Data Types: `single` | `double`

References

- [1] Murty, Katta G. "An algorithm for ranking all the assignments in order of increasing cost." *Operations research* 16, no. 3 (1968): 682-687.
- [2] Samuel Blackman and Robert Popoli. *Design and Analysis of Modern Tracking Systems*, Artech House, 1999.
- [3] Miller, M. L., et al. "Optimizing Murty's Ranked Assignment Method." *IEEE Transactions on Aerospace and Electronic Systems*, vol. 33, no. 3, July 1997, pp. 851-62. DOI.org (Crossref), doi:10.1109/7.599256.

Extended Capabilities

C/C++ Code Generation

Generate C and C++ code using MATLAB® Coder™.

See Also

Functions

`assignTOMHT` | `assignauction` | `assignjv` | `assignkbestsd` | `assignmunkres` | `assignsd` | `trackerGNN` | `trackerTOMHT`

Introduced in R2018b

assignkbestsd

K-best S-D solution that minimizes total cost of assignment

Syntax

```
[assignments, cost, solutionGap] = assignkbestsd(costmatrix)
[assignments, cost, solutionGap] = assignkbestsd(costmatrix, k)
[assignments, cost, solutionGap] = assignkbestsd(costmatrix, k, desiredGap)
[assignments, cost, solutionGap] = assignkbestsd(costmatrix, k, desiredGap,
maxIterations)
[assignments, cost, solutionGap] = assignkbestsd(costmatrix, k, desiredGap,
maxIterations, algorithm)
```

Description

[assignments, cost, solutionGap] = assignkbestsd(costmatrix) returns a table of assignments of detections to tracks by finding the best S-D solution that minimizes the total cost of the assignments. The algorithm uses Lagrangian relaxation to convert the S-D assignment problem to a corresponding 2-D assignment problem and then solves the 2-D problem. The cost of each potential assignment is contained in the cost matrix, `costmatrix`.

`costmatrix` is an n -dimensional cost matrix where `costmatrix(i, j, k, ...)` defines the cost of the n -tuple (i, j, k, \dots) in assignment. The index '1' on all dimensions in `costmatrix` represents dummy measurement or a false track and is used to complete the assignment problem. The index 1, being a dummy, can be a part of multiple n -tuples. The index can be assigned more than once. A typical cost value for `costmatrix(1, 1, 1, 1, ...)` is 0.

The function also returns the solution gap, `solutionGap`, and the cost of assignments, `cost`.

[assignments, cost, solutionGap] = assignkbestsd(costmatrix, k) also specifies the number, k , of K -best S-D solutions. The function finds K optimal solutions that minimize the total cost. First, the function finds the best solution. Then, the function uses the Murty algorithm to generate partitioned cost matrices. Finally, the function obtains the remaining $K - 1$ minimum cost solutions for each partitioned matrix.

[assignments, cost, solutionGap] = assignkbestsd(costmatrix, k, desiredGap) also specifies the desired maximum gap, `desiredGap`, between the dual solution and the feasible solution. The gap controls the quality of the solution. Values usually range from 0 to 1. A value of 0 means the dual and feasible solutions are the same.

[assignments, cost, solutionGap] = assignkbestsd(costmatrix, k, desiredGap, maxIterations) also specifies the maximum number of iterations allowed. The `desiredGap` and `maxIterations` arguments define the terminating conditions for the S-D algorithm.

[assignments, cost, solutionGap] = assignkbestsd(costmatrix, k, desiredGap, maxIterations, algorithm) also specifies the `algorithm` for finding the assignments.

Examples

Assign Detections to Tracks Using K-Best SD

Find the first 5 best assignments of the S-D assignment problem. Set the desired gap to 0.01 and the maximum number of iterations to 100.

Load the cost matrix.

```
load passiveAssociationCostMatrix.mat
```

Find the 5 best solutions.

```
[assignments,cost,solutionGap] = assignkbestsd(costMatrix,5,0.01,100)
```

```
assignments=5×1 cell array
    {2×3 uint32}
    {3×3 uint32}
    {3×3 uint32}
    {3×3 uint32}
    {3×3 uint32}
```

```
cost = 5×1
```

```
-34.7000
-31.7000
-29.1000
-28.6000
-28.0000
```

```
solutionGap = 5×1
```

```
0
0.0552
0.0884
0.1075
0.1964
```

Input Arguments

costmatrix — Cost matrix

real-valued M -by- N

Cost matrix, specified as an n -dimensional array where `costmatrix(i,j,k ...)` defines the cost of the n -tuple (i,j,k, \dots) in an assignment. The index '1' on all dimensions in `costmatrix` represents a dummy measurement or a false track and is used to complete the assignment problem. The index 1, being a dummy, can be a part of multiple n -tuples. The index can be assigned more than once. A typical cost value for `costmatrix(1,1,1,1, ...)` is 0.

Data Types: `single` | `double`

k — Number of best solutions

1 (default) | positive integer

Number of best solutions, specified as a positive integer.

Data Types: `single` | `double`

desiredGap — Desired maximal gap

0.01 (default) | nonnegative scalar

Desired maximum gap between the dual and feasible solutions, specified as a nonnegative scalar.

Example: 0.05

Data Types: `single` | `double`

maxIterations — Maximum number of iterations

100 (default) | positive integer

Maximum number of iterations, specified as a positive integer.

Example: 50

Data Types: `single` | `double`

algorithm — Assignment algorithm

'auction' (default) | 'munkres' | 'jv'

Assignment algorithm for solving the 2-D assignment problem, specified as 'munkres' for the Munkres algorithm, 'jv' for the Jonker-Volgenant algorithm, or 'auction' for the Auction algorithm.

Example: 'jv'

Output Arguments

assignments — Assignment of tracks to detections

K -element cell array

Assignments of tracks to detections, returned as a K -element cell array. Each cell is an P -by- N list of assignments. Assignments of the type $[1 \ 1 \ Q \ 1]$ from a four-dimensional cost matrix can be seen as a $Q-1$ entity from dimension 3 that was left unassigned. The cost value at $(1, 1, Q, 1)$ defines the cost of not assigning the $(Q-1)^{\text{th}}$ entity from dimension 3.

cost — Total cost of solutions

K -element array

Total cost of solutions, returned as a K -element vector where K is the number of best solutions. Each element is a scalar value summarizing the total cost of the solution to the assignment problem.

Data Types: `single` | `double`

solutionGap — Solution gap

real-valued K -element array

Solution gap, returned as a positive-valued K -element array where K is the number of best solutions. Each element is the duality gap achieved between the feasible and dual solution. A gap value near zero indicates the quality of solution.

Data Types: `single` | `double`

Algorithms

All numeric inputs can be single or double precision, but they all must have the same precision.

References

- [1] Popp, R.L., Pattipati, K., and Bar Shalom, Y. "*M-best S=D Assignment Algorithm with Application to Multitarget Tracking*". IEEE Transactions on Aerospace and Electronic Systems, 37(1), 22-39. 2001.
- [2] Deb, S., Yeddanapudi, M., Pattipati, K., & Bar-Shalom, Y. (1997). "*A generalized SD assignment algorithm for multisensor-multitarget state estimation*". IEEE Transactions on Aerospace and Electronic Systems, 33(2), 523-538.

Extended Capabilities

C/C++ Code Generation

Generate C and C++ code using MATLAB® Coder™.

See Also

Functions

`assignTOMHT` | `assignauction` | `assignjv` | `assignkbest` | `assignmunkres` | `assignsd` | `trackerGNN` | `trackerTOMHT`

Introduced in R2018b

assignmunkres

Munkres global nearest neighbor assignment algorithm

Syntax

```
[assignments,unassignedrows,unassignedcolumns] = assignmunkres(costmatrix,
costofnonassignment)
```

Description

`[assignments,unassignedrows,unassignedcolumns] = assignmunkres(costmatrix, costofnonassignment)` returns a table of assignments of detections to tracks using the Munkres algorithm. The Munkres algorithm obtains an optimal solution to the global nearest neighbor (GNN) assignment problem. An optimal solution minimizes the total cost of the assignments.

The cost of each potential assignment is contained in the cost matrix, `costmatrix`. Each matrix entry represents the cost of a possible assignments. Matrix rows represent tracks and columns represent detections. All possible assignments are represented in the cost matrix. The lower the cost, the more likely the assignment is to be made. Each track can be assigned to at most one detection and each detection can be assigned to at most one track. If the number of rows is greater than the number of columns, some tracks are unassigned. If the number of columns is greater than the number of rows, some detections are unassigned. You can set an entry of `costmatrix` to `Inf` to prohibit an assignment.

`costofnonassignment` represents the cost of leaving tracks or detections unassigned. Higher values increase the likelihood that every existing object is assigned.

The function returns a list of unassigned tracks, `unassignedrows`, and a list of unassigned detections, `unassignedcolumns`

Examples

Assign Detections to Tracks Using Munkres Algorithm

Use `assignMunkres` to assign three detections to two tracks.

Start with two predicted track locations in x-y coordinates.

```
tracks = [1,1; 2,2];
```

Assume three detections are received. At least one detection will not be assigned.

```
dets = [1.1, 1.1; 2.1, 2.1; 1.5, 3];
```

Construct a cost matrix by defining the cost of assigning a detection to a track as the Euclidean distance between them. Set the cost of non-assignment to 0.2.

```
for i = size(tracks, 1):-1:1
    delta = dets - tracks(i, :);
    costMatrix(i, :) = sqrt(sum(delta .^ 2, 2));
```

```
end
```

```
costofnonassignment = 0.2;
```

Use the Auction algorithm to assign detections to tracks.

```
[assignments, unassignedTracks, unassignedDetections] = ...  
    assignmentmunkres(costMatrix, costofnonassignment);
```

Display the assignments.

```
disp(assignments)
```

```
 1  1  
 2  2
```

Show that there are no unassigned tracks.

```
disp(unassignedTracks)
```

Display the unassigned detections.

```
disp(unassignedDetections)
```

```
 3
```

Plot detection to track assignments.

```
plot(tracks(:, 1), tracks(:, 2), '*', dets(:, 1), dets(:, 2), 'o')  
hold on  
xlim([0, 4])  
ylim([0, 4])  
legend('tracks', 'detections')  
assignStr = strsplit(num2str(1:size(assignments,1)));  
text(tracks(assignments(:, 1),1) + 0.1, ...  
     tracks(assignments(:, 1),2) - 0.1, assignStr);  
text(dets(assignments(:, 2),1) + 0.1, ...  
     dets(assignments(:, 2),2) - 0.1, assignStr);  
text(dets(unassignedDetections(:,1) + 0.1, ...  
     dets(unassignedDetections(:,2) + 0.1, 'unassigned');
```

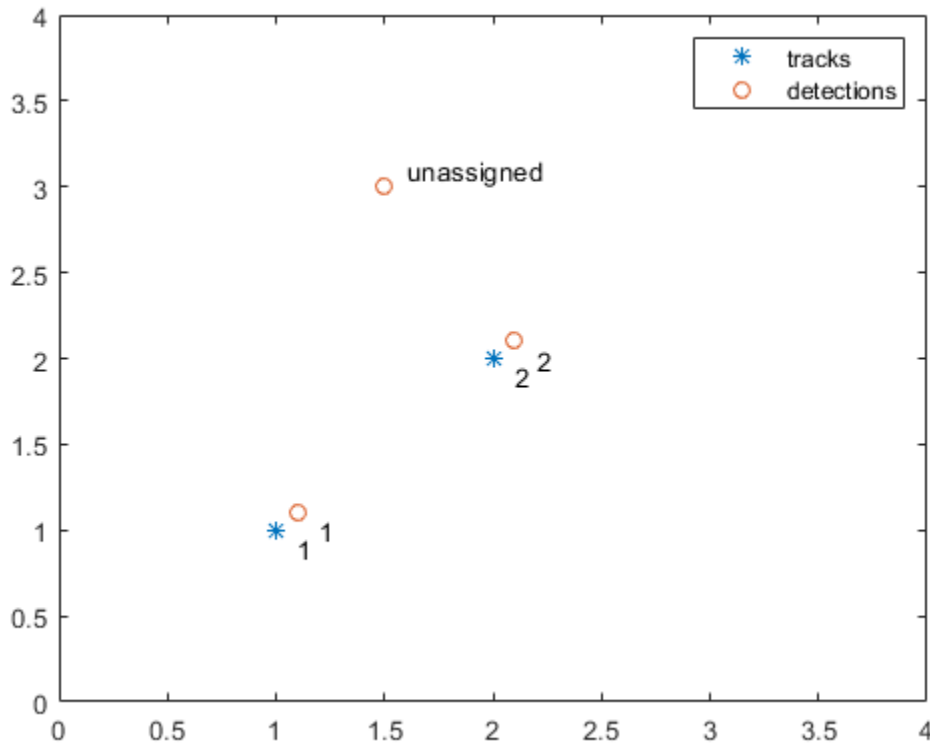

The track to detection assignments are:

- 1 Detection 1 is assigned to track 1.
- 2 Detection 2 is assigned to track 2.
- 3 Detection 3 is not assigned.

Input Arguments

costmatrix — Cost matrix

real-valued M -by- N

Cost matrix, specified as an M -by- N matrix. M is the number of tracks to be assigned and N is the number of detections to be assigned. Each entry in the cost matrix contains the cost of a track and detection assignment. The matrix may contain `Inf` entries to indicate that an assignment is prohibited. The cost matrix cannot be a sparse matrix.

Data Types: `single` | `double`

costofnonassignment — cost of non-assignment of tracks and detections

scalar

Cost of non-assignment, specified as a scalar. The cost of non-assignment represents the cost of leaving tracks or detections unassigned. Higher values increase the likelihood that every object is assigned. The value cannot be set to `Inf`.

Data Types: `single` | `double`

Output Arguments

assignments — Assignment of tracks to detections

integer-valued L -by-2 matrix

Assignment of detections to track, returned as an integer-valued L -by-2 matrix where L is the number of assignments. The first column of the matrix contains the assigned track indices and the second column contains the assigned detection indices.

Data Types: `uint32`

unassignedrows — Indices of unassigned tracks

integer-valued P -by-1 column vector

Indices of unassigned tracks, returned as an integer-valued P -by-1 column vector.

Data Types: `uint32`

unassignedcolumns — Indices of unassigned detections

integer-valued Q -by-1 column vector

Indices of unassigned detections, returned as an integer-valued Q -by-1 column vector.

Data Types: `uint32`

References

[1] Samuel S. Blackman and Popoli, R. *Design and Analysis of Modern Tracking Systems*. Artech House: Norwood, MA. 1999.

Extended Capabilities

C/C++ Code Generation

Generate C and C++ code using MATLAB® Coder™.

See Also

Functions

`assignTOMHT` | `assignauction` | `assignjv` | `assignkbest` | `assignkbestsd` | `assignsd` | `trackerGNN` | `trackerTOMHT`

Introduced in R2018b

assignsd

S-D assignment using Lagrangian relaxation

Syntax

```
[assignments, cost, solutionGap] = assignsd(costmatrix)
[assignments, cost, solutionGap] = assignsd(costmatrix, desiredGap)
[assignments, cost, solutionGap] = assignsd(costmatrix, desiredGap,
maxIterations)
[assignments, cost, solutionGap] = assignsd(costmatrix, desiredGap,
maxIterations, algorithm)
```

Description

`[assignments, cost, solutionGap] = assignsd(costmatrix)` returns a table of assignments, `assignments`, of detections to tracks by finding a suboptimal solution to the S-D assignment problem using Lagrangian relaxation. The cost of each potential assignment is contained in the cost matrix, `costmatrix`. The algorithm terminates when the gap reaches below 0.01 (1 percent) or if the number of iterations reaches 100.

`costmatrix` is an n-dimensional cost matrix where `costmatrix(i, j, k ...)` defines the cost of the n-tuple `(i, j, k, ...)` in assignment. The index '1' on all dimensions in `costmatrix` represents dummy measurement or a false track and is used to complete the assignment problem. The index 1, being a dummy, can be a part of multiple n-tuples. The index can be assigned more than once. A typical cost value for `costmatrix(1, 1, 1, 1, ...)` is 0.

All inputs can be single or double precision, but they all must be of the same precision.

The function also returns the solution gap, `solutionGap`, and the total cost of assignments, `cost`.

`[assignments, cost, solutionGap] = assignsd(costmatrix, desiredGap)` also specifies the desired maximum gap, `desiredGap`, between the dual and the feasible solutions as a scalar. The gap controls the quality of the solution. Values usually range from 0 to 1. A value of 0 means the dual and feasible solutions are the same.

`[assignments, cost, solutionGap] = assignsd(costmatrix, desiredGap, maxIterations)` also specifies the maximum number of iterations, `maxIterations`.

`[assignments, cost, solutionGap] = assignsd(costmatrix, desiredGap, maxIterations, algorithm)` also specifies the assignment algorithm, `algorithm`.

Examples

Assign Detections to Tracks Using assignsd Algorithm

Use `assignsd` to perform strict assignment without index 1.

Not having dummy index means that no entity is left unassigned. Therefore, define the cost matrix to be equi-dimensional.

```
costMatrix = rand(6,6,6);
```

Initialize the `fullMatrix` to all Inf. The `fullMatrix` is one size larger than the cost matrix in all dimensions.

```
fullMatrix = inf(7,7,7);
```

Set the inner matrix to `costMatrix` to force the assignments involving index 1 to have infinite cost.

```
fullMatrix(2:end,2:end,2:end) = costMatrix;  
fullMatrix(1,1,1) = 0;  
[assignments,cost,gapAchieved] = assignsd(fullMatrix,0.01,100);
```

Restore the actual indices.

```
assignments = assignments - 1
```

```
assignments = 6x3 uint32 matrix
```

```
 1  6  6  
 2  4  3  
 3  3  4  
 4  1  2  
 5  2  1  
 6  5  5
```

Input Arguments

costmatrix — Cost matrix

real-valued M -by- N

Cost matrix, specified as an n -dimensional array where `costmatrix(i,j,k ...)` defines the cost of the n -tuple (i,j,k, \dots) in an assignment. The index '1' on all dimensions in `costmatrix` represents a dummy measurement or a false track and is used to complete the assignment problem. The index 1, being a dummy, can be a part of multiple n -tuples. The index can be assigned more than once. A typical cost value for `costmatrix(1,1,1,1, ...)` is 0.

Data Types: `single` | `double`

desiredGap — Desired maximal gap

0.01 (default) | nonnegative scalar

Desired maximum gap between the dual and feasible solutions, specified as a nonnegative scalar.

Example: 0.05

Data Types: `single` | `double`

maxIterations — Maximum number of iterations

100 (default) | positive integer

Maximum number of iterations, specified as a positive integer.

Example: 50

Data Types: `single` | `double`

algorithm — Assignment algorithm

'auction' (default) | 'munkres' | 'jv'

Assignment algorithm for solving the 2-D assignment problem, specified as 'munkres' for the Munkres algorithm, 'jv' for the Jonker-Volgenant algorithm, or 'auction' for the Auction algorithm.

Example: 'jv'

Output Arguments**assignments — Assignment of tracks to detections***P*-by-*N* matrix

Assignments of tracks to detections, returned as a *P*-by-*N* list of assignments. Assignments of the type [1 1 *Q* 1] from a four-dimensional cost matrix can be seen as a *Q*-1 entity from dimension 3 that was left unassigned. The cost value at (1, 1, *Q*, 1) defines the cost of not assigning the (*Q*-1)th entity from dimension 3.

cost — Total cost of assignment solution

positive scalar

Total cost of solutions, returned as a *K*-element vector where *K* is the number of best solutions. Each element is a scalar value summarizing the total cost of the solution to the assignment problem.

Data Types: single | double

solutionGap — Solution gap

positive scalar (default)

Solution gap, returned as a positive scalar. The solution gap is the duality gap achieved between the feasible and dual solution. A gap value near zero indicates the quality of solution.

Data Types: single | double

Algorithms

- The Lagrangian relaxation method computes a suboptimal solution to the S-D assignment problem. The method relaxes the S-D assignment problem to a 2-D assignment problem using a set of Lagrangian multipliers. The relaxed 2-D assignment problem is commonly known as the dual problem, which can be solved optimally using algorithms like the Munkres algorithm. Constraints are then enforced on the dual solution by solving multiple 2-D assignment problems to obtain a feasible solution to the original problem. The cost of the dual solution and the feasible solution serves as lower and upper bounds on the optimal cost, respectively. The algorithm iteratively tries to minimize the gap between the dual and feasible solutions, commonly known as the dual gap. The iteration stops when the dual gap is below a desired gap or the maximum number of iterations have reached.
- When using the auction algorithm, the assignsd function uses the Heuristic Price Update algorithm to update the Lagrangian multipliers. When using the Munkres and JV algorithms, the function uses the Accelerated Subgradient Update algorithm.
- For cost matrices with well-defined solutions, such as passive association with high-precision sensors, the solution gap converges to within 0.05 (5 percent) in approximately 100 iterations.

- As the optimal solution is unknown, the solution gap can be non-zero even when the returned solution is optimal.

References

- [1] Deb, S., Yeddanapudi, M., Pattipati, K., and Bar-Shalom, Y. (1997). *A generalized SD assignment algorithm for multisensor-multitarget state estimation*. IEEE Transactions on Aerospace and Electronic Systems, 33(2), 523-538.
- [2] Blackman, Samuel, and Robert Popoli. *Design and analysis of modern tracking systems*. Norwood, MA: Artech House, 1999. (1999)

Extended Capabilities

C/C++ Code Generation

Generate C and C++ code using MATLAB® Coder™.

- In the generated code, `assignsd` returns an output with a fixed number of columns because it does not drop trailing singleton dimensions of variable-size arrays. In MATLAB, `assignsd` returns a variable-length output because it drops trailing singleton dimensions.

See Also

Functions

`assignTOMHT` | `assignauction` | `assignjv` | `assignkbest` | `assignkbestsd` | `assignmunkres` | `trackerGNN` | `trackerTOMHT`

Introduced in R2018b

assignTOMHT

Track-oriented multi-hypotheses tracking assignment

Syntax

```
[assignments,unassignedrows,unassignedcolumns] = assignTOMHT(costmatrix,
costThreshold)
```

Description

[assignments,unassignedrows,unassignedcolumns] = assignTOMHT(costmatrix, costThreshold) returns a table of assignments, assignments, of detections to tracks using a track-oriented multi-hypothesis algorithm (TOMHT).

The cost of each potential assignment is contained in the cost matrix, `costmatrix`. Each matrix entry represents the cost of a possible assignments. Matrix rows represent tracks and columns represent detections. All possible assignments are represented in the cost matrix. The lower the cost, the more likely the assignment is to be made. Each track can be assigned to at most one detection and each detection can be assigned to at most one track. If the number of rows is greater than the number of columns, some tracks are unassigned. If the number of columns is greater than the number of rows, some detections are unassigned. You can set an entry of `costmatrix` to `Inf` to prohibit an assignment.

`costThreshold` represents the set of three gates used for assigning detections to tracks.

The function returns a list of unassigned tracks, `unassignedrows`, and a list of unassigned detections, `unassignedcolumns`.

Examples

Assignment Using AssignTOMHT

Find the assignments from a cost matrix using `assignTOMHT` with a nonzero C1 gate and a nonzero C2 gate.

Create a cost matrix that assigns:

- Track 1 to detection 1 within the C1 gate and detection 2 within the C2 gate.
- Track 2 to detection 2 within the C2 gate and detection 3 within the C3 gate.
- Track 3 is unassigned.
- Detection 4 is unassigned.

```
costMatrix = [4 9 200 Inf; 300 12 28 Inf; 32 100 210 1000];
costThresh = [5 10 30];
```

Calculate the assignments.

```
[assignments, unassignedTracks, unassignedDets] = assignTOMHT(costMatrix,costThresh)
```

`assignments = 4x2 uint32 matrix`

```
1 1
1 2
2 2
2 3
```

`unassignedTracks = 2x1 uint32 column vector`

```
2
3
```

`unassignedDets = 2x1 uint32 column vector`

```
3
4
```

Tracks that are assigned detections within the C1 gate are not considered as unassigned. For example, track 1. Detections that are assigned to tracks within the C2 gate are not considered as unassigned. For example, detections 1 and 2.

Input Arguments

costmatrix — Cost matrix

real-valued M -by- N

Cost matrix, specified as an M -by- N matrix. M is the number of tracks to be assigned and N is the number of detections to be assigned. Each entry in the cost matrix contains the cost of a track and detection assignment. The matrix may contain `Inf` entries to indicate that an assignment is prohibited. The cost matrix cannot be a sparse matrix.

Data Types: `single` | `double`

costThreshold — Assignment gates

positive, real-valued 3-element vector

Assignment gates, specified as a positive, real-valued three-element vector `[c1gate,c2gate,c3gate]` where `c1gate <= c2gate <= c3gate`.

Example: `[0.1,0.3,0.5]`

Data Types: `single` | `double`

Output Arguments

assignments — Assignment of tracks to detections

integer-valued L -by-2 matrix

Assignment of detections to track, returned as an integer-valued L -by-2 matrix where L is the number of assignments. The first column of the matrix contains the assigned track indices and the second column contains the assigned detection indices.

Data Types: `uint32`

unassignedrows — Indices of unassigned tracks

integer-valued P -by-1 column vector

Indices of unassigned tracks, returned as an integer-valued P -by-1 column vector.

Data Types: uint32

unassignedcolumns — Indices of unassigned detections

integer-valued Q -by-1 column vector

Indices of unassigned detections, returned as an integer-valued Q -by-1 column vector.

Data Types: uint32

Algorithms

Assignment Thresholds for Multi-Hypothesis Tracker

Three assignment thresholds, C_1 , C_2 , and C_3 , control (1) the assignment of a detection to a track, (2) the creation of a new branch from a detection, and (3) the creation of a new branch from an unassigned track. The threshold values must satisfy: $C_1 \leq C_2 \leq C_3$.

If the cost of an assignment is $C = \text{costmatrix}(i, j)$, the following hypotheses are created based on comparing the cost to the values of the assignment thresholds. Below each comparison, there is a list of the possible hypotheses.

- Track
- Detection

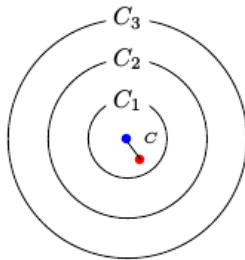

$$C \leq C_1$$

Single Hypothesis

- (1) Detection is assigned to track. A branch is created updating the track with this detection.

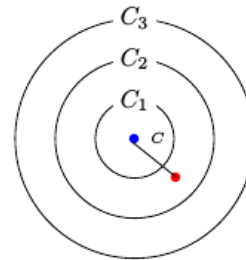

$$C_1 < C \leq C_2$$

Two Hypotheses

- (1) Detection is assigned to track. A branch is created updating the track with this detection.
- (2) Track is not assigned to detection and is coasted.

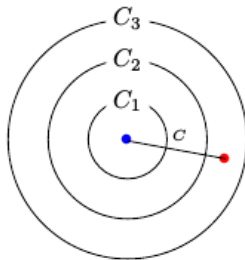

$$C_2 < C \leq C_3$$

Three Hypotheses

- (1) Detection is assigned to track. A branch is created updating the track with this detection.
- (2) Track is not assigned to detection and is coasted.
- (3) Detection is not assigned and creates a new track (branch).

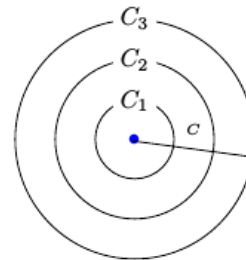

$$C_3 < C$$

Single Hypothesis

- (1) Detection is not assigned and creates a new track (branch).

Tips:

- Increase the value of C_3 if there are detections that should be assigned to tracks but are not. Decrease the value if there are detections that are assigned to tracks they should not be assigned to (too far away).
- Increasing the values C_1 and C_2 helps control the number of track branches that are created. However, doing so reduces the number of branches (hypotheses) each track has.
- To allow each track to be unassigned, set $C_1 = 0$.
- To allow each detection to be unassigned, set $C_2 = 0$.

References

- [1] Werthmann, John R. "*Step-by-step description of a computationally efficient version of multiple hypothesis tracking.*" In *Signal and Data Processing of Small Targets 1992*, vol. 1698, pp. 288-300. International Society for Optics and Photonics, 1992.

Extended Capabilities

C/C++ Code Generation

Generate C and C++ code using MATLAB® Coder™.

See Also

Functions

`assignauction` | `assignjv` | `assignkbest` | `assignkbestsd` | `assignmunkres` | `assignsd` | `trackerGNN` | `trackerTOMHT`

Introduced in R2018b

fusecovint

Covariance fusion using covariance intersection

Syntax

```
[fusedState,fusedCov] = fusecovint(trackState,trackCov)
[fusedState,fusedCov] = fusecovint(trackState,trackCov,minProp)
```

Description

`[fusedState,fusedCov] = fusecovint(trackState,trackCov)` fuses the track states in `trackState` and their corresponding covariance matrices `trackCov`. The function computes the fused state and covariance as an intersection of the individual covariances. It creates a convex combination of the covariances and finds weights that minimize the determinant of the fused covariance matrix.

`[fusedState,fusedCov] = fusecovint(trackState,trackCov,minProp)` estimates the fused covariance by minimizing `minProp`, which can be either the determinant or the trace of the fused covariance matrix.

Examples

Covariance Intersection Fusion Using Default Values

Define a state vector of tracks.

```
x(:,1) = [1;2;0];
x(:,2) = [2;2;0];
x(:,3) = [2;3;0];
```

Define the covariance matrices of the tracks.

```
p(:,:,1) = [10 5 0; 5 10 0; 0 0 1];
p(:,:,2) = [10 -5 0; -5 10 0; 0 0 1];
p(:,:,3) = [12 9 0; 9 12 0; 0 0 1];
```

Estimate the fused state vector and its covariance.

```
[fusedState,fusedCov] = fusecovint(x,p);
```

Use `trackPlotter` to plot the results.

```
tPlotter = theaterPlot('XLim',[-10 10],'YLim',[-10 10],'ZLim',[-10 10]);
tPlotter1 = trackPlotter(tPlotter, ...
    'DisplayName','Input Tracks','MarkerEdgeColor',[0.000 0.447 0.741]);
tPlotter2 = trackPlotter(tPlotter,'DisplayName', ...
    'Fused Track','MarkerEdgeColor',[0.850 0.325 0.098]);
plotTrack(tPlotter1,x',p)
plotTrack(tPlotter2,fusedState',fusedCov)
title('Covariance Intersection Fusion')
```

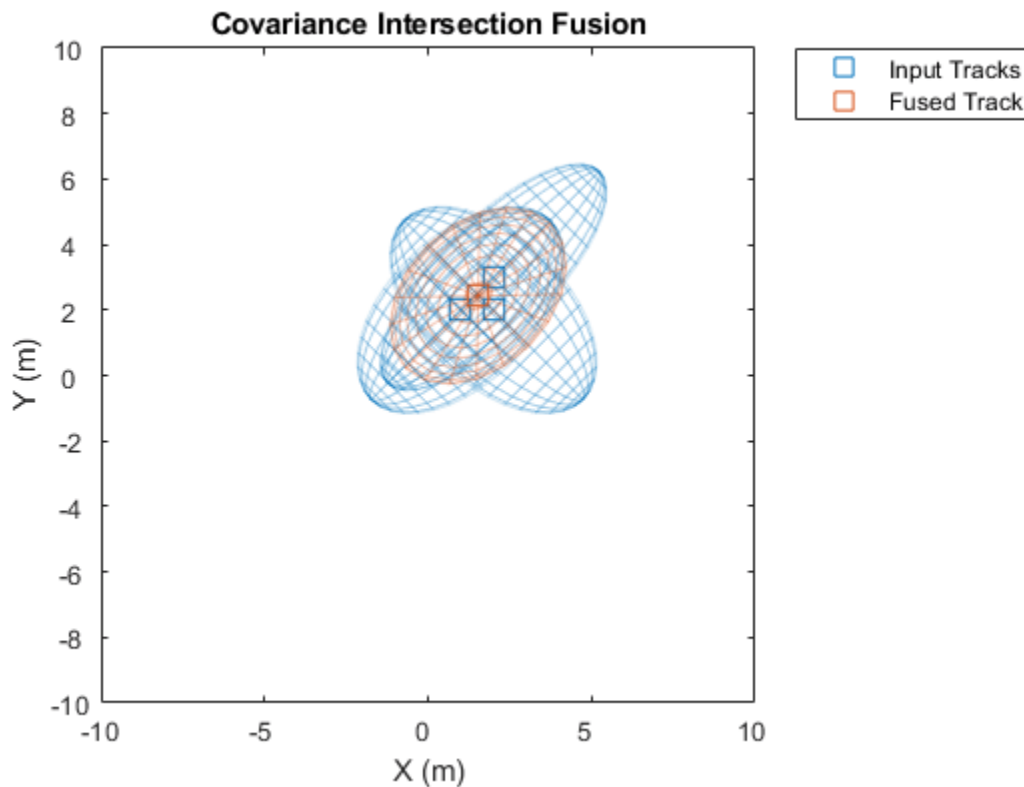

Covariance Intersection Fusion Using Trace Minimization

Define a state vector of tracks.

```
x(:,1) = [1;2;0];
x(:,2) = [2;2;0];
x(:,3) = [2;3;0];
```

Define the covariance matrices of the tracks.

```
p(:,:,1) = [10 5 0; 5 10 0; 0 0 1];
p(:,:,2) = [10 -5 0; -5 10 0; 0 0 1];
p(:,:,3) = [12 9 0; 9 12 0; 0 0 1];
```

Estimate the fused state vector and its covariance. Combine the original covariances so that the trace of the fused covariance matrix is minimized.

```
[fusedState,fusedCov] = fusecovint(x,p,'trace');
```

Use trackPlotter to plot the results.

```
tPlotter = theaterPlot('XLim',[-10 10],'YLim',[-10 10],'ZLim',[-10 10]);
tPlotter1 = trackPlotter(tPlotter, ...
    'DisplayName','Input Tracks','MarkerEdgeColor',[0.000 0.447 0.741]);
tPlotter2 = trackPlotter(tPlotter, ...
```

```

'DisplayName', 'Fused Track', 'MarkerEdgeColor', [0.850 0.325 0.098]);
plotTrack(tPlotter1,x',p)
plotTrack(tPlotter2,fusedState',fusedCov)
title('Covariance Intersection Fusion')

```

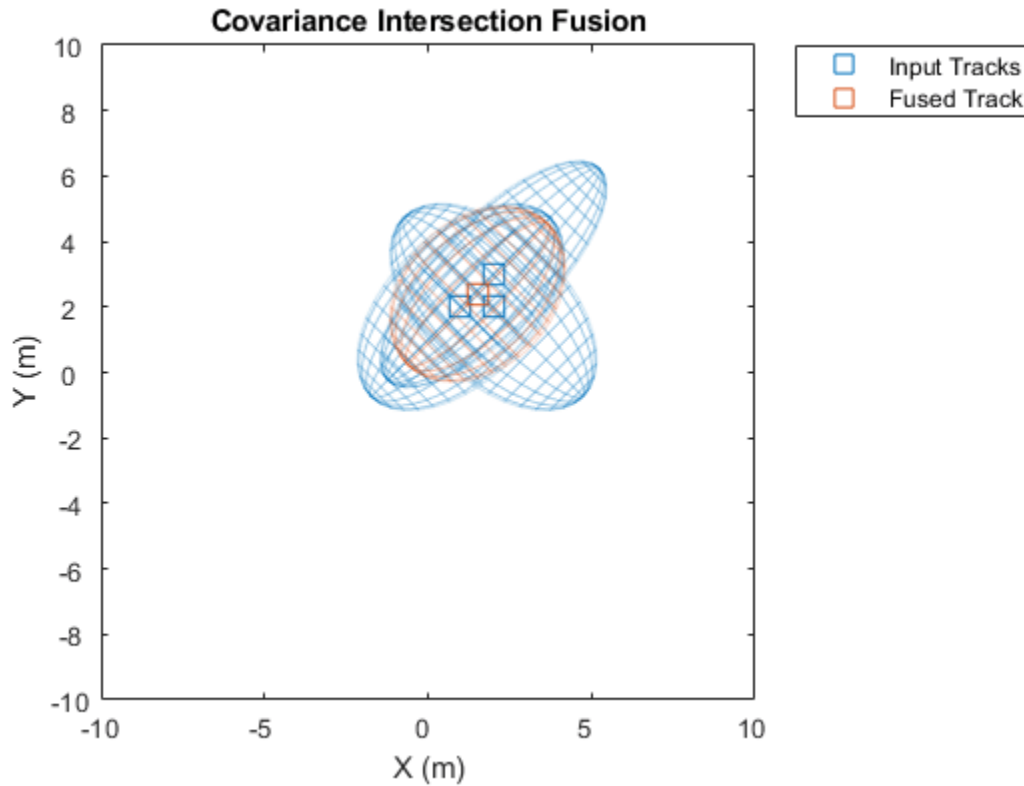

Input Arguments

trackState — Track states

N -by- M matrix

Track states, specified as an N -by- M matrix, where N is the dimension of the state and M is the number of tracks.

Data Types: single | double

trackCov — Track covariance matrices

N -by- N -by- M array

Track covariance matrices, specified as an N -by- N -by- M array, where N is the dimension of the state and M is the number of tracks.

Data Types: single | double

minProp — Property to minimize

'det' (default) | 'trace'

Property to minimize when estimating the fused covariance, specified as 'det' or 'trace'.

.

Data Types: char | string

Output Arguments

fusedState — Fused state

N -by-1 vector

Fused state, returned as an N -by-1 vector, where N is the dimension of the state.

fusedCov — Fused covariance matrix

N -by- N matrix

Fused covariance matrix, returned as an N -by- N matrix, where N is the dimension of the state.

References

- [1] Matzka, Stephan, and Richard Altendorfer. "A comparison of track-to-track fusion algorithms for automotive sensor fusion." In *Multisensor Fusion and Integration for Intelligent Systems*, pp. 69-81. Springer, Berlin, Heidelberg, 2009.
- [2] Julier, Simon, and Jeffrey K. Uhlmann. "General decentralized data fusion with covariance intersection." In *Handbook of multisensor data fusion*, pp. 339-364. CRC Press, 2017.

Extended Capabilities

C/C++ Code Generation

Generate C and C++ code using MATLAB® Coder™.

See Also

fusecovunion | fusexcov

Introduced in R2018b

fusecovunion

Covariance fusion using covariance union

Syntax

```
[fusedState,fusedCov] = fusecovunion(trackState,trackCov)
```

Description

[fusedState,fusedCov] = fusecovunion(trackState,trackCov) fuses the track states in trackState and their corresponding covariance matrices trackCov. The function estimates the fused state and covariance in a way that maintains consistency. For more details, see “Consistent Estimator” on page 1-460.

Examples

Covariance Union Fusion

Define a state vector of tracks.

```
x(:,1) = [1;2;0];  
x(:,2) = [2;2;0];  
x(:,3) = [2;3;0];
```

Define the covariance matrices of the tracks.

```
p(:,:,1) = [10 5 0; 5 10 0;0 0 1];  
p(:,:,2) = [10 -5 0; -5 10 0;0 0 1];  
p(:,:,3) = [12 9 0; 9 12 0;0 0 1];
```

Estimate the fused state vector and its covariance.

```
[fusedState,fusedCov] = fusecovunion(x,p);
```

Use trackPlotter to plot the results.

```
tPlotter = theaterPlot('XLim',[-10 10],'YLim',[-10 10],'ZLim',[-10 10]);  
tPlotter1 = trackPlotter(tPlotter, ...  
    'DisplayName','Input Tracks','MarkerEdgeColor',[0.000 0.447 0.741]);  
tPlotter2 = trackPlotter(tPlotter, ...  
    'DisplayName','Fused Track','MarkerEdgeColor',[0.850 0.325 0.098]);  
plotTrack(tPlotter1,x',p)  
plotTrack(tPlotter2, fusedState', fusedCov)  
title('Covariance Union Fusion')
```

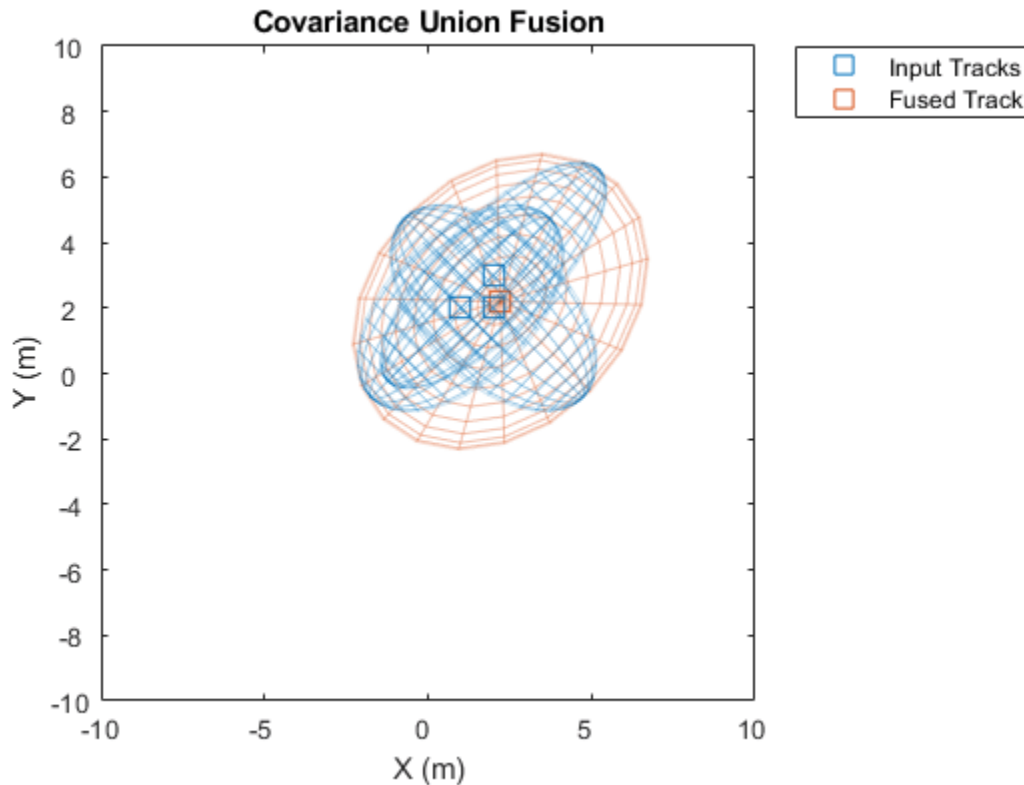

Input Arguments

trackState — Track states

N -by- M matrix

Track states, specified as an N -by- M matrix, where N is the dimension of the state and M is the number of tracks.

Data Types: `single` | `double`

trackCov — Track covariance matrices

N -by- N -by- M array

Track covariance matrices, specified as an N -by- N -by- M array, where N is the dimension of the state and M is the number of tracks.

Data Types: `single` | `double`

Output Arguments

fusedState — Fused state

N -by-1 vector

Fused state, returned as an N -by-1 vector, where N is the dimension of the state.

fusedCov — Fused covariance matrix*N*-by-*N* matrix

Fused covariance matrix, returned as an *N*-by-*N* matrix, where *N* is the dimension of the state.

More About**Consistent Estimator**

A *consistent estimator* is an estimator that converges in probability to the quantity being estimated as the sample size grows. In the case of tracking, a position estimate is consistent if its covariance (error) matrix is not smaller than the covariance of the actual distribution of the true state about the estimate. The covariance union method guarantees consistency by ensuring that all the individual means and covariances are bounded by the fused mean and covariance.

References

- [1] Reece, Steven, and Stephen Rogers. "Generalised Covariance Union: A Unified Approach to Hypothesis Merging in Tracking." *IEEE® Transactions on Aerospace and Electronic Systems*. Vol. 46, No. 1, Jan. 2010, pp. 207-221.

Extended Capabilities**C/C++ Code Generation**

Generate C and C++ code using MATLAB® Coder™.

See Also

fusecovint | fusexcov

Introduced in R2018b

fusexcov

Covariance fusion using cross-covariance

Syntax

```
[fusedState,fusedCov] = fusexcov(trackState,trackCov)
[fusedState,fusedCov] = fusexcov(trackState,trackCov,crossCovFactor)
```

Description

`[fusedState,fusedCov] = fusexcov(trackState,trackCov)` fuses the track states in `trackState` and their corresponding covariance matrices `trackCov`. The function estimates the fused state and covariance within a Bayesian framework in which the cross-correlation between tracks is unknown.

`[fusedState,fusedCov] = fusexcov(trackState,trackCov,crossCovFactor)` specifies a cross-covariance factor for the effective correlation coefficient when computing the cross-covariance.

Examples

Cross-Covariance Fusion Using Default Values

Define a state vector of tracks.

```
x(:,1) = [1;2;0];
x(:,2) = [2;2;0];
x(:,3) = [2;3;0];
```

Define the covariance matrices of the tracks.

```
p(:,:,1) = [10 5 0; 5 10 0;0 0 1];
p(:,:,2) = [10 -5 0; -5 10 0;0 0 1];
p(:,:,3) = [12 9 0; 9 12 0;0 0 1];
```

Estimate the fused state vector and its covariance.

```
[fusedState,fusedCov] = fusexcov(x,p);
```

Use `trackPlotter` to plot the results.

```
tPlotter = theaterPlot('XLim',[-10 10],'YLim',[-10 10],'ZLim',[-10 10]);
tPlotter1 = trackPlotter(tPlotter, ...
    'DisplayName','Input Tracks','MarkerEdgeColor',[0.000 0.447 0.741]);
tPlotter2 = trackPlotter(tPlotter, ...
    'DisplayName','Fused Track','MarkerEdgeColor',[0.850 0.325 0.098]);
plotTrack(tPlotter1,x',p)
plotTrack(tPlotter2,fusedState',fusedCov)
title('Cross-Covariance Fusion')
```

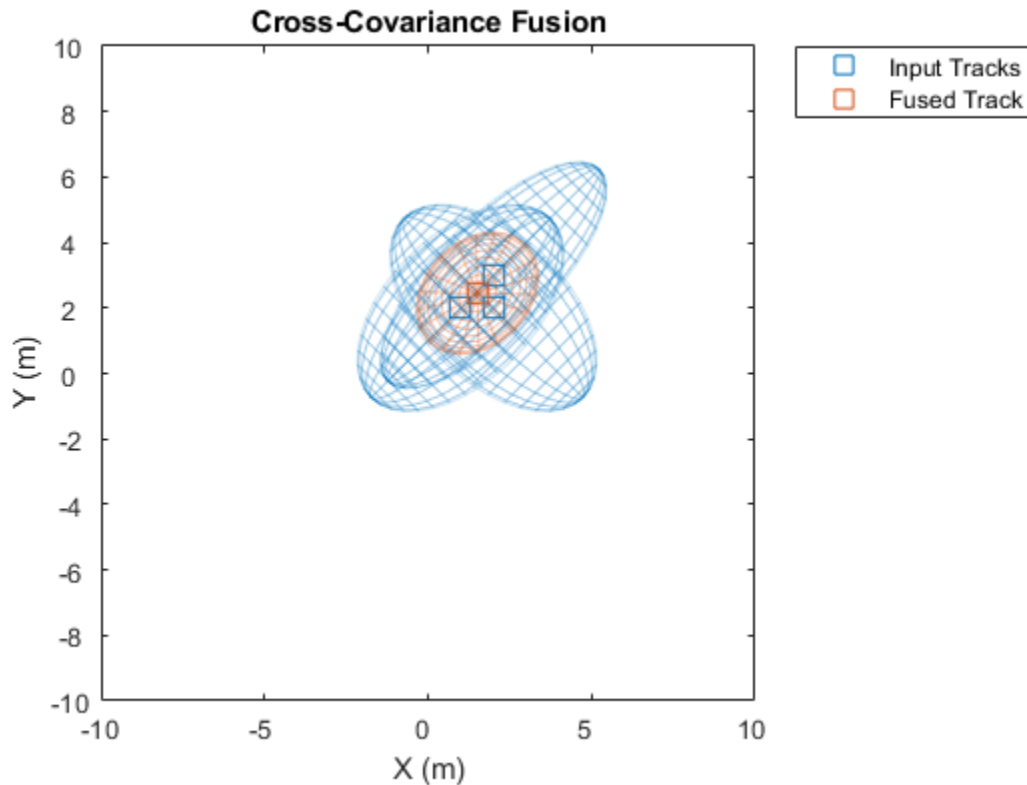

Cross-Covariance Fusion Using Cross-Covariance Factor

Define a state vector of tracks.

```
x(:,1) = [1;2;0];
x(:,2) = [2;2;0];
x(:,3) = [2;3;0];
```

Define the covariance matrices of the tracks.

```
p(:,:,1) = [10 5 0; 5 10 0; 0 0 1];
p(:,:,2) = [10 -5 0; -5 10 0; 0 0 1];
p(:,:,3) = [12 9 0; 9 12 0; 0 0 1];
```

Estimate the fused state vector and its covariance. Specify a cross-covariance factor of 0.5.

```
[fusedState,fusedCov] = fusexcov(x,p,0.5);
```

Use trackPlotter to plot the results.

```
tPlotter = theaterPlot('XLim',[-10 10],'YLim',[-10 10],'ZLim',[-10 10]);
tPlotter1 = trackPlotter(tPlotter, ...
    'DisplayName','Input Tracks','MarkerEdgeColor',[0.000 0.447 0.741]);
tPlotter2 = trackPlotter(tPlotter, ...
    'DisplayName','Fused Track','MarkerEdgeColor',[0.850 0.325 0.098]);
```

```

plotTrack(tPlotter1,x',p)
plotTrack(tPlotter2, fusedState', fusedCov)
title('Cross-Covariance Fusion')

```

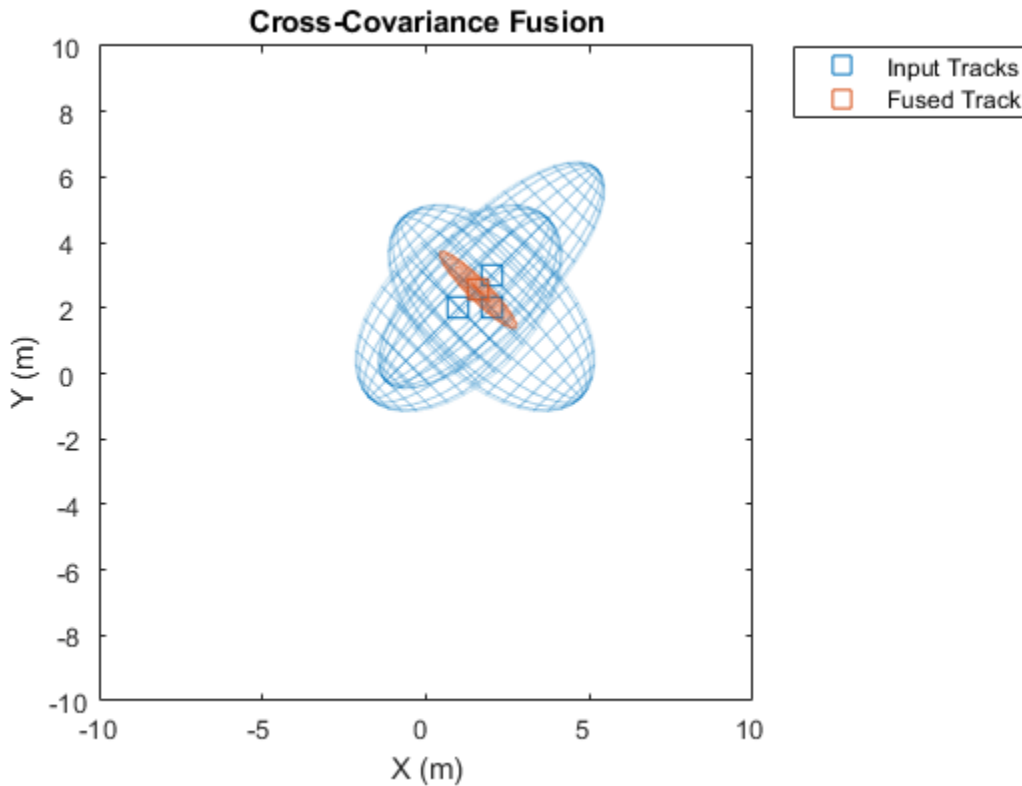

Input Arguments

trackState — Track states

N -by- M matrix

Track states, specified as an N -by- M matrix, where N is the dimension of the state and M is the number of tracks.

Data Types: single | double

trackCov — Track covariance matrices

N -by- N -by- M array

Track covariance matrices, specified as an N -by- N -by- M array, where N is the dimension of the state and M is the number of tracks.

Data Types: single | double

crossCovFactor — Cross-covariance factor

0.4 (default) | scalar

Cross-covariance factor, specified as a scalar.

Data Types: `single` | `double`

Output Arguments

fusedState — Fused state

N -by-1 vector

Fused state, returned as an N -by-1 vector, where N is the dimension of the state.

fusedCov — Fused covariance matrix

N -by- N matrix

Fused covariance matrix, returned as an N -by- N matrix, where N is the dimension of the state.

References

- [1] Bar-Shalom, Yaakov, and Xiao-Rong Li. *Multitarget-multisensor tracking: principles and techniques*. Vol. 19. Storrs, CT: YBs, 1995.
- [2] Weng, Zhiyuan, and Petar M. Djurić. "A bayesian approach to covariance estimation and data fusion." In 2012 Proceedings of the 20th European Signal Processing Conference , pp. 2352-2356. IEEE, 2012.
- [3] Matzka, Stephan, and Richard Altendorfer. "A comparison of track-to-track fusion algorithms for automotive sensor fusion." In *Multisensor Fusion and Integration for Intelligent Systems*, pp. 69-81. Springer, Berlin, Heidelberg, 2009.

Extended Capabilities

C/C++ Code Generation

Generate C and C++ code using MATLAB® Coder™.

See Also

`fusecovint` | `fusecovunion`

Introduced in R2018b

clusterTrackBranches

Cluster track-oriented multi-hypothesis history

Syntax

```
[clusters,incompatibleBranches] = clusterTrackBranches(branchHistory)
[clusters,incompatibleBranches] = clusterTrackBranches(
branchHistory,'OutputForm',out)
```

Description

`[clusters,incompatibleBranches] = clusterTrackBranches(branchHistory)` computes the clusters and incompatibility matrix for a set of branches.

Branches i , j , and k belong to the same cluster if branches i and j are pairwise-incompatible and branches j and k are pairwise-incompatible. Two branches are pairwise-incompatible if they share a track ID (the first column of `branchHistory`) or if they share detections that fall in their gates during the number of recent scans as specified by the history depth.

`[clusters,incompatibleBranches] = clusterTrackBranches(branchHistory,'OutputForm',out)` returns the clusters in the format specified by `out`.

Examples

Compute Clusters of Branches

Create a branch history matrix for 12 branches. For this example, the branch history matrix has 11 columns that represent the history of 2 sensors with a history depth of 4.

```
branchHistory = uint32([
    4     9     9     0     0     1     0     0     0     0     0
    5    10    10     0     0     0     2     0     0     0     0
    6    11    11     0     0     3     0     0     0     0     0
    1    12    12     0     0     1     0     1     0     0     0
    1    13    13     0     0     0     2     1     0     0     0
    1    14    14     0     0     1     2     1     0     0     0
    2    15    15     0     0     3     0     3     0     0     0
    3    16    16     0     0     0     4     0     4     0     0
    7     0    17     1     0     0     0     0     0     0     0
    1     5    18     1     0     0     0     0     2     0     0
    1     5    19     0     2     0     0     0     2     0     0
    1     5    20     1     2     0     0     0     2     0     0]);
```

Get the list of clusters and the list of incompatible branches. The `clusters` matrix has three columns, therefore there are three clusters.

```
[clusters,incompBranches] = clusterTrackBranches(branchHistory);
size(clusters)
```

```
ans = 1x2
```

12 3

Show the incompatible branches as a graph. The numeric branch IDs are in the third column of `branchHistory`. To display the IDs of the branches on the graph, convert the IDs to character vectors. You can see the three distinct clusters.

```
branchIDs = cellstr(num2str(branchHistory(:,3)));
g = graph(incompBranches,branchIDs,'omitselfloops');
plot(g)
```

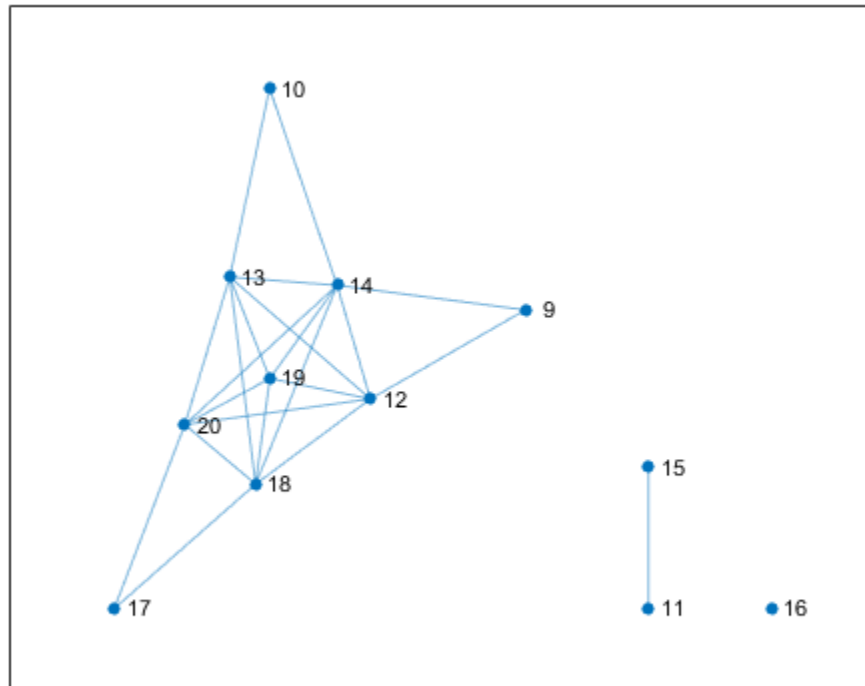

Input Arguments

branchHistory — Branch history

matrix of integers

Branch history, specified as a matrix of integers. Each row of `branchHistory` represents a unique track branch. `branchHistory` must have $3+(D \times S)$ columns, where D is the number of maintained scans (the history depth) and S is the maximum number of maintained sensors. For more information, see the history output of the `trackBranchHistory` system object.

out — Output form

'logical' (default) | 'vector' | 'cell'

Output form of the returned clusters, specified as 'logical', 'vector', or 'cell'.

Output Arguments

clusters – Clusters

M-by-*P* logical matrix | *M*-element numeric vector | cell array

Clusters, returned as one of the following. The format of `clusters` is specified by `out`.

- An *M*-by-*P* logical matrix. *M* is the number of branches (rows) in `branchHistory` and *P* is the number of clusters. The (*i,j*) element is `true` if branch *j* is contained in cluster *i*. The value of *P* is less than or equal to *M*.
- A vector of length *M*, where the *i*-th element gives the index of the cluster that contains branch *i*.
- A cell array `c`, where `c{j}` contains the IDs of all the branches in cluster *j*.

Data Types: `logical`

incompatibleBranches – Incompatible branches

M-by-*M* symmetric logical matrix

Incompatible branches, returned as an *M*-by-*M* symmetric logical matrix. The (*i,j*) element is `true` if branches *i* and *j* are pairwise-incompatible.

Data Types: `logical`

References

- [1] Werthmann, John R. "A Step-by-Step Description of a Computationally Efficient Version of Multiple Hypothesis Tracking." In *Proceedings of SPIE Vol. 1698, Signal and Processing of Small Targets*. 1992, pp. 288-300. doi: 10.1117/12.139379.

Extended Capabilities

C/C++ Code Generation

Generate C and C++ code using MATLAB® Coder™.

Usage notes and limitations:

- Code generation only supports the `'logical'` value of output form `out`.

See Also

`compatibleTrackBranches` | `pruneTrackBranches` | `trackBranchHistory` | `trackerTOMHT`

Introduced in R2018b

compatibleTrackBranches

Formulate global hypotheses from clusters

Syntax

```
[hypotheses, hypScores] = compatibleTrackBranches(clusters,
incompatibleBranches, scores, maxNumHypotheses)
```

Description

[hypotheses, hypScores] = compatibleTrackBranches(clusters, incompatibleBranches, scores, maxNumHypotheses) returns the list of hypotheses hypotheses and their scores hypScores from information about clusters of branches and incompatibility of branches.

Hypotheses are sets of compatible track branches, which are branches that do not belong to the same track or share a detection in their history. The score of each hypothesis is the sum of scores of all branches included in the hypothesis.

Examples

Get Hypotheses of Branches

Create a branch history matrix for 12 branches. For this example, the branch history matrix has 11 columns that represent the history of 2 sensors with a history depth of 4.

```
branchHistory = uint32([
    4     9     9     0     0     1     0     0     0     0     0
    5    10    10     0     0     0     2     0     0     0     0
    6    11    11     0     0     3     0     0     0     0     0
    1    12    12     0     0     1     0     1     0     0     0
    1    13    13     0     0     0     2     1     0     0     0
    1    14    14     0     0     1     2     1     0     0     0
    2    15    15     0     0     3     0     3     0     0     0
    3    16    16     0     0     0     4     0     4     0     0
    7     0    17     1     0     0     0     0     0     0     0
    1     5    18     1     0     0     0     0     2     0     0
    1     5    19     0     2     0     0     0     2     0     0
    1     5    20     1     2     0     0     0     2     0     0]);
```

Get the list of clusters and the list of incompatible branches. The clusters matrix has three columns, therefore there are three clusters.

```
[clusters, incompBranches] = clusterTrackBranches(branchHistory);
```

Specify a 12-by-1 column vector containing the branch scores.

```
scores = [81.4; 90.5; 12.7; 91.3; 63.2; 9.7; 27.8; 54.6; 95.7; 96.4; 15.7; 97.1];
```

Specify the number of global hypotheses.

```
numHypotheses = 6;
```

Get a matrix of hypotheses and the score of each hypothesis.

```
[hyps, hypScores] = compatibleTrackBranches(clusters, incompBranches, scores, numHypotheses)
```

hyps = 12x6 logical array

```

1  0  1  1  1  0
1  1  1  1  1  1
0  0  0  0  1  1
0  1  0  0  0  1
0  0  0  0  0  0
0  0  0  0  0  0
1  1  1  1  0  0
1  1  1  1  1  1
1  1  0  0  1  1
0  0  0  1  0  0
:

```

hypScores = 1x6

```
365.7000  359.9000  351.4000  350.7000  350.6000  344.8000
```

Input Arguments

clusters — Clusters

M-by-*P* logical matrix | *M*-element numeric vector | cell array

Clusters, specified as one of the following.

- An *M*-by-*P* logical matrix. *M* is the number of branches and *P* is the number of clusters. The (*i*,*j*) element is `true` if branch *j* is contained in cluster *i*. The value of *P* is less than or equal to *M*.
- A vector of length *M*, where the *i*-th element gives the index of the cluster that contains branch *i*.
- A cell array *c*, where *c*{*j*} contains the IDs of all the branches in cluster *j*.

You can use `clusterTrackBranches` to compute the clusters from a branch history matrix.

Data Types: `logical`

incompatibleBranches — Incompatible branches

M-by-*M* symmetric logical matrix

Incompatible branches, specified as an *M*-by-*M* symmetric logical matrix. The (*i*,*j*) element is `true` if branches *i* and *j* are pairwise-incompatible.

You can use `clusterTrackBranches` to compute incompatible branches from a branch history matrix.

Data Types: `logical`

scores — Branch scores

M-by-1 numeric vector | *M*-by-2 numeric matrix

Branch scores, specified as an M -by-1 numeric vector or an M -by-2 numeric matrix.

Note If you specify `scores` as an M -by-2 numeric matrix, then the first column specifies the current score of each branch and the second column specifies the maximum score. `compatibleTrackBranches` ignores the second column.

Data Types: `single` | `double`

maxNumHypotheses — Maximum number of hypotheses

positive integer

Maximum number of hypotheses, specified as a positive integer.

Output Arguments

hypotheses — Hypotheses

M -by- H logical matrix

Hypotheses, returned as an M -by- H logical matrix, where M is the number of branches and H is the value of `maxNumHypotheses`.

hypScores — Hypotheses score

1-by- H numeric vector

Hypotheses score, returned as a 1-by- H numeric vector.

References

[1] Werthmann, John R. "A Step-by-Step Description of a Computationally Efficient Version of Multiple Hypothesis Tracking." In *Proceedings of SPIE Vol. 1698, Signal and Processing of Small Targets*. 1992, pp. 288-300. doi: 10.1117/12.139379.

Extended Capabilities

C/C++ Code Generation

Generate C and C++ code using MATLAB® Coder™.

Usage notes and limitations:

- Code generation only supports `clusters` specified as an M -by- P logical matrix.

See Also

`clusterTrackBranches` | `pruneTrackBranches` | `trackBranchHistory` | `trackerTOMHT`

Introduced in R2018b

pruneTrackBranches

Prune track branches with low likelihood

Syntax

```
[toPrune,globalProbability] = pruneTrackBranches(branchHistory,scores,
hypotheses)
[toPrune,globalProbability] = pruneTrackBranches(branchHistory,scores,
hypotheses,Name,Value)
[toPrune,globalProbability,info] = pruneTrackBranches( ___ )
```

Description

[toPrune,globalProbability] = pruneTrackBranches(branchHistory,scores,hypotheses) returns a logical flag, toPrune, that indicates which branches should be pruned based on the branch history, branch scores, and hypotheses. pruneTrackBranches also returns the global branch probabilities, globalProbability.

[toPrune,globalProbability] = pruneTrackBranches(branchHistory,scores,hypotheses,Name,Value) uses name-value pairs to modify how branches are pruned.

[toPrune,globalProbability,info] = pruneTrackBranches(___) returns additional information, info, about the pruned branches.

Examples

Prune Branches For Single Sensor Using N-Scan Pruning

Create a branch history matrix for a single sensor with 20 branches. For this example, the history depth is 4 therefore the matrix has 7 columns.

```
history = [
    8    14    14    0    0    2    0
    1    23    23    0    0    2    1
    2    24    24    0    0    1    2
    9    25    25    0    1    0    0
   10    26    26    0    2    0    0
    1    28    28    0    1    0    1
    4    33    33    0    1    2    1
    1    34    34    0    1    2    1
    2    35    35    0    2    1    2
   11     0    36    1    0    0    0
   12     0    37    2    0    0    0
    8    14    38    2    0    2    0
    1    23    39    2    0    2    1
    2    24    40    1    0    1    2
    9    25    41    2    1    0    0
   10    26    42    1    2    0    0
    1    28    43    2    1    0    1
    4    33    44    2    1    2    1
```

```

1   34   45   2   1   2   1
2   35   46   1   2   1   2];

```

Get the list of clusters and the list of incompatible branches. The `clusters` matrix has two columns, therefore there are two clusters.

```
[clusters,incompBranches] = clusterTrackBranches(history);
```

Specify a 20-by-1 column vector containing branch scores.

```
scores = [4.5 44.9 47.4 6.8 6.8 43.5 50.5 61.9 64.7 9.1 9.1 19 61.7 ...
63.5 21.2 20.5 60.7 67.3 79.2 81.5]';
```

Get a matrix of hypothesis.

```
hypotheses = compatibleTrackBranches(clusters,incompBranches,scores,10);
```

Prune the track branches, using name-value pair arguments to specify a single sensor and the 'Hypothesis' method of N-scan pruning. Return the pruning flag, global probability, and pruning information about each branch. To make the information easier to compare, convert the information from a struct to a table.

The i -th value of `toPrune` is true if any of 'PrunedByProbability', 'PrunedByNScan', or 'PrunedByNumBranches' are true in the i -th row of the information table.

```
[toPrune,probs,info] = pruneTrackBranches(history,scores,hypotheses, ...
'NumSensors',1,'NScanPruning','Hypothesis');
infoTable = struct2table(info)
```

```
infoTable=20x6 table
   BranchID   PriorProbability   GlobalProbability   PrunedByProbability   PrunedByNScan
   _____   _____   _____   _____   _____
    14         0.98901         0.098901         false         false
    23          1         0.1         false         false
    24          1         0.1         false         false
    25         0.99889         0.099889         false         false
    26         0.99889         0.099889         false         false
    28          1         0         true         true
    33          1         0         true         false
    34          1         0.2         false         false
    35          1         0.2         false         false
    36         0.99989         0.19998         false         false
    37         0.99989         0.19998         false         false
    38          1         0         true         false
    39          1         0.1         false         false
    40          1         0.1         false         false
    41          1         0.1         false         false
    42          1         0.1         false         false
    :
```

Input Arguments

branchHistory — Branch history

matrix of integers

Branch history, specified as a matrix of integers. Each row of `branchHistory` represents a unique track branch. `branchHistory` must have $3+(D \times S)$ columns, where D is the number of maintained scans (the history depth) and S is the maximum number of maintained sensors. For more information, see the `history` output of the `trackBranchHistory` system object.

scores — Branch scores

M-by-1 numeric vector | *M*-by-2 numeric matrix

Branch scores, specified as an *M*-by-1 numeric vector or an *M*-by-2 numeric matrix.

Note If you specify `scores` as an *M*-by-2 numeric matrix, then the first column specifies the current score of each branch and the second column specifies the maximum score. `pruneTrackBranches` ignores the second column.

Data Types: `single` | `double`

hypotheses — Hypotheses

M-by-*H* logical matrix

Hypotheses, returned as an *M*-by-*H* logical matrix, where M is the number of branches and H is the number of global hypotheses. You can use `clusterTrackBranches` to compute the clusters from a branch history matrix, then use `compatibleTrackBranches` to compute the hypotheses from the clusters.

Name-Value Pair Arguments

Specify optional comma-separated pairs of `Name`, `Value` arguments. `Name` is the argument name and `Value` is the corresponding value. `Name` must appear inside quotes. You can specify several name and value pair arguments in any order as `Name1, Value1, ..., NameN, ValueN`.

Example: `[toPrune, probs] = pruneTrackBranches(branchHistory, scores, hypotheses, 'MinBranchProbability', 2e-3);`

MinBranchProbability — Minimum branch probability

1e-3 (default) | number in the range [0,1)

Minimum branch probability threshold, specified as the comma-separated pair consisting of `'MinBranchProbability'` and a number in the range [0,1). Typical values are between 1e-3 and 5e-3. The `pruneTrackBranches` function prunes branches with global probability less than the threshold.

MaxNumTrackBranches — Maximum number of branches

3 (default) | positive integer

Maximum number of branches to keep per track, specified as the comma-separated pair consisting of `'MaxNumTrackBranches'` and a positive integer. Typical values are between 2 and 6. If a track has more than this number of branches, then `pruneTrackBranches` prunes branches with the lowest initial score.

NScanPruning — N-scan pruning method

'None' (default) | 'Hypothesis'

N-scan pruning method, specified as the comma-separated pair consisting of 'NScanPruning' and 'None' or 'Hypothesis'. If you specify 'Hypothesis', then `pruneTrackBranches` prunes branches that are incompatible with the current most likely branch in the most recent N scans. By default, `pruneTrackBranches` does not use N-scan pruning.

NumSensors — Number of sensors

20 (default) | positive integer

Number of sensors in history, specified as the comma-separated pair consisting of 'NumSensors' and a positive integer.

Output Arguments

toPrune — Branches to prune

M -by-1 logical vector

Branches to prune, returned as an M -by-1 logical vector. A value of `true` indicates that the branch should be pruned.

Data Types: `logical`

globalProbability — Global branch probabilities

M -by-1 numeric vector

Global branch probabilities, returned as an M -by-1 numeric vector.

info — Pruning information

struct

Pruning information about each branch, returned as a struct with the following fields.

- **BranchID** — An M -by-1 numeric vector. Each value specifies the ID of a track branch. The IDs come from the third column of `branchHistory`.
- **PriorProbability** — An M -by-1 numeric vector. Each value specifies the branch prior probability from the branch score.
- **GlobalProbability** — An M -by-1 numeric vector. Each value specifies the branch global probability, which considers the hypotheses that contain the branch and their scores.
- **PrunedByProbability** — An M -by-1 logical vector. A value of `true` indicates that the branch is pruned by `MinBranchProbability`.
- **PrunedByNScan** — An M -by-1 logical vector. A value of `true` indicates that the branch is pruned by `NScanPruning`.
- **PrunedByNumBranches** — An M -by-1 logical vector. A value of `true` indicates that the branch is pruned by `MaxNumTrackBranches`.

References

- [1] Werthmann, John R. "A Step-by-Step Description of a Computationally Efficient Version of Multiple Hypothesis Tracking." In *Proceedings of SPIE Vol. 1698, Signal and Processing of Small Targets*. 1992, pp. 288-300. doi: 10.1117/12.139379.
- [2] Blackman, Samuel, and Robert Popoli. "Design and Analysis of Modern Tracking Systems." Artech House, 1999.

Extended Capabilities

C/C++ Code Generation

Generate C and C++ code using MATLAB® Coder™.

See Also

[clusterTrackBranches](#) | [compatibleTrackBranches](#) | [trackBranchHistory](#) | [trackerTOMHT](#)

Introduced in R2018b

triangulateLOS

Triangulate multiple line-of-sight detections

Syntax

```
estPos = triangulateLOS(detections)
[estPos,estCov] = triangulateLOS(detections)
```

Description

`estPos = triangulateLOS(detections)` estimates the position of a target in a global Cartesian coordinate frame by triangulating a set of angle-only detections. Angle-only detections are also known as line-of-sight (LOS) detections. For more details, see “Algorithms” on page 1-479.

`[estPos,estCov] = triangulateLOS(detections)` also returns `estCov`, the covariance of the error in target position. The function uses a Taylor-series approximation to estimate the error covariance.

Examples

Triangulate Line-of-Sight Measurements from Three Sensors

Load a MAT-file containing a set of line-of-sight detections stored in the variable `detectionSet`.

```
load angleOnlyDetectionFusion.mat
```

Plot the angle-only detections and the sensor positions. Specify a range of 5 km for plotting the direction vector. To specify the position of the origin, use the second measurement parameter because the sensor is located at the center of the platform. Convert the azimuth and elevation readings to Cartesian coordinates.

```
rPlot = 5000;

for i = 1:numel(detectionSet)
    originPos = detectionSet{i}.MeasurementParameters(2).OriginPosition;

    az = detectionSet{i}.Measurement(1);
    el = detectionSet{i}.Measurement(2);
    [xt, yt, zt] = sph2cart(deg2rad(az), deg2rad(el), rPlot);

    positionData(:, i) = originPos;
    plotData(:, 3*i+(-2:0)) = [xt yt zt]' .* [1 0 NaN] + originPos;
end

plot3(positionData(1,:), positionData(2,:), positionData(3,:), '*')
hold on
plot3(plotData(1,:), plotData(2,:), plotData(3,:))
```

Triangulate the detections by using `triangulateLOS`. Plot the triangulated position.

```
[estPos,estCov] = triangulateLOS(detectionSet);

plot3(estPos(1),estPos(2),estPos(3),'pk','MarkerFaceColor','k')
hold off

legend('Sensor Positions','Angle-Only Detections','Triangulated Position', ...
'location','southeast')
xlabel('x [m]')
ylabel('y [m]')
view(2)
```

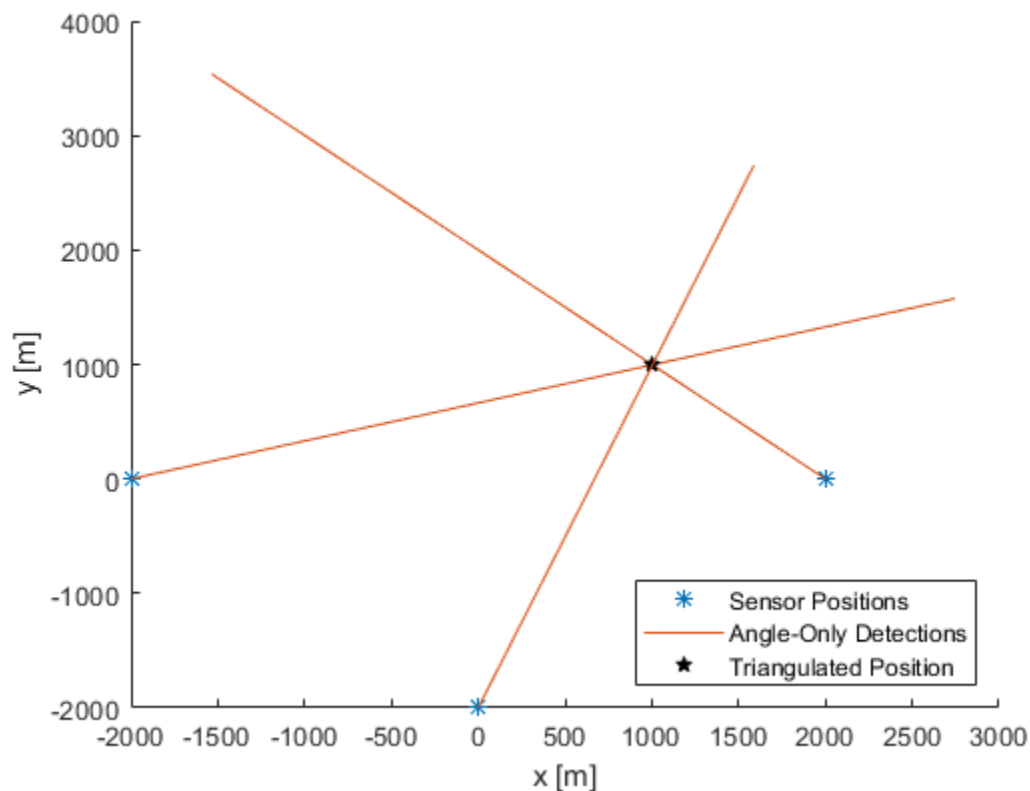

Input Arguments

detections — Line-of-sight measurements

cell array of objectDetection objects

Line-of-sight measurements, specified as a cell array of objectDetection objects. Each object has the properties listed in the table.

Property	Definition
Time	Measurement time
Measurement	Object measurements
MeasurementNoise	Measurement noise covariance matrix

Property	Definition
SensorIndex	Unique ID of the sensor
ObjectClassID	Object classification
ObjectAttributes	Additional information passed to tracker
MeasurementParameters	Parameters used by initialization functions of nonlinear Kalman tracking filters

Each detection must specify the `MeasurementParameters` property as a structure with the fields described in the table.

Parameter	Definition
Frame	Frame used to report measurements. Specify <code>Frame</code> as 'spherical' for the first structure.
OriginPosition	Position offset of the origin of the frame relative to the parent frame, represented as a 3-by-1 real vector.
OriginVelocity	Velocity offset of the origin of the frame relative to the parent frame, represented as a 3-by-1 real vector.
Orientation	A 3-by-3 real-valued orthonormal frame orientation matrix.
IsParentToChild	A logical scalar that indicates if <code>Orientation</code> is given as a frame rotation from the parent coordinate frame to the child coordinate frame. If <code>false</code> , then <code>Orientation</code> is given as a frame rotation from the child coordinate frame to the parent coordinate frame.
HasElevation	A logical scalar that indicates if elevation is included in the measurements. This parameter is <code>true</code> by default.
HasAzimuth	A logical scalar that indicates if azimuth is included in the measurements. This parameter is <code>true</code> by default. If specified as a field, it must be set to <code>true</code> .
HasRange	A logical scalar that indicates if range is included in the measurements. This parameter must be specified as a field and set to <code>false</code> .
HasVelocity	A logical scalar that indicates if velocity is included in the measurements. This parameter is <code>false</code> by default. If specified as a field, it must be set to <code>false</code> .

The function provides default values for fields left unspecified.

Output Arguments

estPos — Estimated position

3-by-1 vector

Estimated position of the target, returned as a 3-by-1 vector.

estCov — Estimated error covariance

3-by-3 matrix

Estimated error covariance of the target position, returned as a 3-by-3 matrix.

Algorithms

Multiple angle-only or line-of-sight measurements result in lines in space. These lines might or might not intersect because of measurement noise. `triangulateLOS` uses a suboptimal linear least-squares method to minimize the distance of miss between multiple detections. The formulation makes these assumptions:

- All detections report measurements with approximately the same accuracy in azimuth and elevation (if measured).
- The distances from the different sensors to the triangulated target are all of the same order.

References

- [1] Blackman, Samuel, and Robert Popoli. "*Design and analysis of modern tracking systems.*" Norwood, MA: Artech House, 1999. (1999).

Extended Capabilities

C/C++ Code Generation

Generate C and C++ code using MATLAB® Coder™.

See Also

Objects

`objectDetection` | `staticDetectionFuser`

Introduced in R2018b

underwaterChannel

Propagated and reflected sonar signals

Syntax

```
sonarsigout = underwaterChannel(sonarsigin,platforms)
```

Description

The `underwaterChannel` function models underwater sonar signal propagation based on a time varying acoustic Green's function approach and uses the image method to account for multipath signal transmission. The function makes these assumptions:

- The function assumes a shallow water (depth less than 200 meters) environment, in which an isospeed channel is valid.
- The function assumes flat and uniform ocean floor and surface and does not account signal loss due to surface interaction.

For more details, see these "References" on page 1-483.

`sonarsigout = underwaterChannel(sonarsigin,platforms)` returns sonar signals, `sonarsigout`, as combinations of signals, `sonarsigin`, reflected from platforms, `platforms`.

Examples

Reflect Sonar Emission From Platform

Create a sonar emission and a platform and reflect the emission from the platform.

Create a sonar emission object.

```
sonarSig = sonarEmission('PlatformID',1,'EmitterIndex',1,'OriginPosition',[0 0 0]);
```

Create a platform structure.

```
platfm = struct('PlatformID',2,'Position',[10 0 0],'Signatures',tsSignature());
```

Reflect the emission from the platform.

```
sigs = underwaterChannel(sonarSig,platfm)
```

```
sigs =  
    2x1 sonarEmission array with properties:
```

```
    SourceLevel  
    TargetStrength  
    PlatformID  
    EmitterIndex  
    OriginPosition  
    OriginVelocity
```



```

Orientation
FieldOfView
CenterFrequency
Bandwidth
WaveformType
ProcessingGain
PropagationRange
PropagationRangeRate

```

Reflect Sonar Emission from Platform within Tracking Scenario

Reflect a sonar emission from a platform defined within a trackingScenario.

Create a tracking scenario object.

```
scenario = trackingScenario;
```

Create an sonarEmitter.

```
emitter = sonarEmitter(1);
```

Mount the emitter on a platform within the scenario.

```
plat = platform(scenario, 'Emitters', emitter);
```

Add another platform to reflect the emitted signal.

```
tgt = platform(scenario);
tgt.Trajectory.Position = [30 0 0];
```

Emit the signal using the emit object function of a platform .

```
txSigs = emit(plat, scenario.SimulationTime)
```

```
txSigs = 1x1 cell array
        {1x1 sonarEmission}
```

Reflect the signal from the platforms in the scenario.

```
sigs = underwaterChannel(txSigs, scenario.Platforms)
```

```
sigs = 1x1 cell array
        {1x1 sonarEmission}
```

Input Arguments

sonarsigin — Input sonar signals

array of sonarEmission objects

Input sonar signals, specified as an array of sonarEmission objects.

platforms – Reflector platform

cell array of Platform objects | array of Platform structures

Reflector platforms, specified as a cell array of Platform objects, Platform, or an array of Platform structures:

Field	Description
PlatformID	Unique identifier for the platform, specified as a scalar positive integer. This is a required field which has no default value.
ClassID	User-defined integer used to classify the type of target, specified as a nonnegative integer. Zero is reserved for unclassified platform types and is the default value.
Position	Position of target in scenario coordinates, specified as a real-valued 1-by-3 vector. This is a required field. There is no default value. Units are in meters.
Velocity	Velocity of platform in scenario coordinates, specified as a real-valued 1-by-3 vector. Units are in meters per second. The default is [0 0 0].
Speed	Speed of the platform in the scenario frame specified as a real scalar. When speed is specified, the platform velocity is aligned with its orientation. Specify either the platform speed or velocity, but not both. Units are in meters per second The default is 0.
Acceleration	Acceleration of the platform in scenario coordinates specified as a 1-by-3 row vector in meters per second-squared. The default is [0 0 0].
Orientation	Orientation of the platform with respect to the local scenario NED coordinate frame, specified as a scalar quaternion or a 3-by-3 rotation matrix. Orientation defines the frame rotation from the local NED coordinate system to the current platform body coordinate system. Units are dimensionless. The default is quaternion(1,0,0,0).
AngularVelocity	Angular velocity of platform in scenario coordinates, specified as a real-valued 1-by-3 vector. The magnitude of the vector defines the angular speed. The direction defines the axis of clockwise rotation. Units are in degrees per second. The default is [0 0 0].

Field	Description
Signatures	Cell array of signatures defining the visibility of the platform to emitters and sensors in the scenario. The default is the cell array {rcsSignature, irSignature, tsSignature}.

If you specify an array of platform structures, set a unique `PlatformID` for each platform and set the `Position` field for each platform. Any other fields not specified are assigned default values.

Output Arguments

sonarsigout — Reflected sonar signals

array of `sonarEmission` objects

Reflected sonar signals, specified as an array of `sonarEmission` objects.

References

- [1] Hung, Wen-Liang, and Shou-Jen Chang-Chien. "Learning-Based EM Algorithm for Normal-Inverse Gaussian Mixture Model with Application to Extrasolar Planets." *Journal of Applied Statistics*, vol. 44, no. 6, Apr. 2017, pp. 978–99. .
- [2] Stojanovic, M., and J. Preisig. "Underwater Acoustic Communication Channels: Propagation Models and Statistical Characterization." *IEEE Communications Magazine*, vol. 47, no. 1, Jan. 2009, pp. 84–89.
- [3] Allen, Jont B., and David A. Berkley. "Image Method for Efficiently Simulating Small-room Acoustics." *The Journal of the Acoustical Society of America*, vol. 65, no. 4, Apr. 1979, pp. 943–50.

Extended Capabilities

C/C++ Code Generation

Generate C and C++ code using MATLAB® Coder™.

See Also

`sonarEmission` | `sonarEmitter` | `sonarSensor`

Introduced in R2018b

emissionsInBody

Transform emissions to body frame of platform

Syntax

```
embody = emissionsInBody(emscene, bodyframe)
```

Description

`embody = emissionsInBody(emscene, bodyframe)` converts emissions, `emscene`, referenced to scenario coordinates into emissions, `embody`, referenced to platform body coordinates. `bodyframe` specifies the position, velocity, and orientation of the platform body.

Examples

Convert Radar Emission to Body Frame

Convert a radar emission from scenario coordinates to body frame.

Define a radar emission with respect to the scenario frame.

```
emScene = radarEmission('PlatformID',1,'EmitterIndex',1, ...
    'OriginPosition',[0 0 0])
```

```
emScene =
    radarEmission with properties:

        PlatformID: 1
        EmitterIndex: 1
        OriginPosition: [0 0 0]
        OriginVelocity: [0 0 0]
        Orientation: [1x1 quaternion]
        FieldOfView: [180 180]
        CenterFrequency: 300000000
        Bandwidth: 3000000
        WaveformType: 0
        ProcessingGain: 0
        PropagationRange: 0
        PropagationRangeRate: 0
        EIRP: 0
        RCS: 0
```

Define the position, velocity, and orientation, of the body relative to the scenario frame.

```
bodyFrame = struct( ...
    'Position',[10 0 0], ...
    'Velocity',[5 5 0], ...
    'Orientation',quaternion([45 0 0], 'eulerd', 'zyx', 'frame'));
```

Convert the emission into the body frame.

```

emBody = emissionsInBody(emScene,bodyFrame)

emBody =
    radarEmission with properties:

        PlatformID: 1
        EmitterIndex: 1
        OriginPosition: [-7.0711 7.0711 0]
        OriginVelocity: [-7.0711 4.4409e-16 0]
        Orientation: [1x1 quaternion]
        FieldOfView: [180 180]
        CenterFrequency: 300000000
        Bandwidth: 3000000
        WaveformType: 0
        ProcessingGain: 0
        PropagationRange: 0
        PropagationRangeRate: 0
        EIRP: 0
        RCS: 0

```

Convert Sonar Emission into Body Frame

Convert a sonar emission from scenario coordinates into body coordinates. Use `trackingScenario` to defined the motion of the body and use `sonarEmitter` to create the emission.

Set up a tracking scenario.

```
scene = trackingScenario;
```

Create a sonar emitter to mount on a platform.

```
emitter = sonarEmitter(1,'No scanning');
```

Mount the emitter on a platform in the scenario 100 meters below sea-level.

```
platTx = platform(scene,'Emitters',emitter);
platTx.Trajectory.Position = [10 0 100];
```

Create another platform in the scenario.

```
platRx = platform(scene);
platRx.Trajectory.Position = [100 0 100];
platRx.Trajectory.Orientation = quaternion([45 0 0],'eulerd', ...
    'zyx','frame');
```

Emit a signal. The emitted signal is in the scenario frame.

```
emScene = emit(platTx,scene.SimulationTime)
```

```
emScene = 1x1 cell array
    {1x1 sonarEmission}
```

Propagate the emission through an underwater channel.

```
emPropScene = underwaterChannel(emScene,scene.Platforms)
```

```
emPropScene=2x1 cell array
    {1x1 sonarEmission}
    {1x1 sonarEmission}
```

Convert the emission to the body frame of the second platform.

```
emBodyRx = emissionsInBody(emPropScene, platRx);
disp(emBodyRx(1))

    {1x1 sonarEmission}
```

Input Arguments

emscene — Emissions in scenario coordinates

emission object

Emissions in scenario coordinates, specified as a cell array of `radarEmission` or `sonarEmission` emission objects.

bodyframe — Body frame

structure | Platform object

Body frame, specified as a structure or `Platform` object. You can use a `Platform` object because it contains the necessary information. The body frame structure must contain at least these fields:

Field	Description
Position	Position of body in scenario coordinates, specified as a real-valued 1-by-3 vector. This field is required. There is no default value. Units are in meters.
Velocity	Velocity of body in scenario coordinates, specified as a real-valued 1-by-3 vector. Units are in meters per second. The default is <code>[0 0 0]</code> .
Orientation	Orientation of body with respect to the scenario coordinate frame, specified as a scalar quaternion or a 3-by-3 rotation matrix. Orientation defines the frame rotation from the scenario coordinate system to the body coordinate system. Units are dimensionless. The default is <code>quaternion(1,0,0,0)</code> or, equivalently, <code>eye(3)</code> .

Because the fields in the body frame structure are a subset of the fields in a platform structure, you can use the platform structure output from the `platformPoses` method of `trackingScenario` as the input `bodyframe`.

Output Arguments

embody — Emissions in body coordinates

emission object

Emissions in body coordinates, returned as a cell array of `radarEmission` and `sonarEmission` emission objects.

Extended Capabilities

C/C++ Code Generation

Generate C and C++ code using MATLAB® Coder™.

See Also

Functions

`radarChannel` | `underwaterChannel`

Objects

`Platform` | `radarEmission` | `radarEmitter` | `sonarEmission` | `sonarEmitter` | `trackingScenario`

Introduced in R2018b

enu2lla

Transform local east-north-up coordinates to geodetic coordinates

Syntax

```
lla = enu2lla(xyzENU,lla0,method)
```

Description

`lla = enu2lla(xyzENU,lla0,method)` transforms the local east-north-up (ENU) Cartesian coordinates `xyzENU` to geodetic coordinates `lla`. Specify the origin of the local ENU system as the geodetic coordinates `lla0`.

Note

- The latitude and longitude values in the geodetic coordinate system use the World Geodetic System of 1984 (WGS84) standard.
 - Specify altitude as height in meters above the WGS84 reference ellipsoid.
-

Examples

Transform ENU Coordinates to Geodetic Coordinates

Specify the geodetic coordinates of the local origin in Zermatt, Switzerland.

```
lla0 = [46.017 7.750 1673]; % [lat0 lon0 alt0]
```

Specify the ENU coordinates of a point of interest, in meters. In this case, the point of interest is the Matterhorn.

```
xyzENU = [-7134.8 -4556.3 2852.4]; % [xEast yNorth zUp]
```

Transform the local ENU coordinates to geodetic coordinates using flat earth approximation.

```
lla = enu2lla(xyzENU,lla0,'flat')
```

```
lla = 1×3  
103 ×
```

```
    0.0460    0.0077    4.5254
```

Input Arguments

xyzENU — Local ENU Cartesian coordinates

three-element row vector | n -by-3 matrix

Local ENU Cartesian coordinates, specified as a three-element row vector or an n -by-3 matrix. n is the number of points to transform. Specify each point in the form $[xEast\ yNorth\ zUp]$. $xEast$, $yNorth$, and zUp are the respective x -, y -, and z -coordinates, in meters, of the point in the local ENU system.

Data Types: `double`

lla0 — Origin of local ENU system in geodetic coordinates

three-element row vector | n -by-3 matrix

Origin of the local ENU system in the geodetic coordinates, specified as a three-element row vector or an n -by-3 matrix. n is the number of origin points. Specify each point in the form $[lat0\ lon0\ alt0]$. $lat0$ and $lon0$ specify the latitude and longitude of the origin, respectively, in degrees. $alt0$ specifies the altitude of the origin in meters.

Data Types: `double`

method — Transformation method

'flat' | 'ellipsoid'

Transformation method, specified as 'flat' or 'ellipsoid'. This argument specifies whether the function assumes the planet is flat or ellipsoidal.

The flat Earth transformation method has these limitations:

- Assumes that the flight path and bank angle are zero.
- Assumes that the flat Earth z -axis is normal to the Earth at only the initial geodetic latitude and longitude. This method has higher accuracy over small distances from the initial geodetic latitude and longitude, and closer to the equator. The method calculates a longitude with higher accuracy when the variation in latitude is smaller.
- Latitude values of +90 and -90 may return unexpected values because of singularity at the poles.

Data Types: `char` | `string`

Output Arguments

lla — Geodetic coordinates

three-element row vector | n -by-3 matrix

Geodetic coordinates, returned as a three-element row vector or an n -by-3 matrix. n is the number of transformed points. Each point is in the form $[lat\ lon\ alt]$. lat and lon specify the latitude and longitude, respectively, in degrees. alt specifies the altitude in meters.

Data Types: `double`

Extended Capabilities

C/C++ Code Generation

Generate C and C++ code using MATLAB® Coder™.

See Also

Functions

lla2enu | lla2ned | ned2lla

ned2lla

Transform local north-east-down coordinates to geodetic coordinates

Syntax

```
lla = ned2lla(xyzNED,lla0,method)
```

Description

`lla = ned2lla(xyzNED,lla0,method)` transforms the local north-east-down (NED) Cartesian coordinates `xyzNED` to geodetic coordinates `lla`. Specify the origin of the local NED system as the geodetic coordinates `lla0`.

Note

- The latitude and longitude values in the geodetic coordinate system use the World Geodetic System of 1984 (WGS84) standard.
 - Specify altitude as height in meters above the WGS84 reference ellipsoid.
-

Examples

Transform NED Coordinates to Geodetic Coordinates

Specify the geodetic coordinates of the local origin in Zermatt, Switzerland.

```
lla0 = [46.017 7.750 1673]; % [lat0 lon0 alt0]
```

Specify the NED coordinates of a point of interest, in meters. In this case, the point of interest is the Matterhorn.

```
xyzNED = [-4556.3 -7134.8 -2852.4]; % [xNorth yEast zDown]
```

Transform the local NED coordinates to geodetic coordinates using flat earth approximation.

```
lla = ned2lla(xyzNED,lla0,'flat')
```

```
lla = 1×3  
103 ×
```

```
    0.0460    0.0077    4.5254
```

Input Arguments

xyzNED — Local NED Cartesian coordinates

three-element row vector | n -by-3 matrix

Local NED Cartesian coordinates, specified as a three-element row vector or an n -by-3 matrix. n is the number of points to transform. Specify each point in the form $[xNorth\ yEast\ zDown]$. $xNorth$, $yEast$, and $zDown$ are the respective x -, y -, and z -coordinates, in meters, of the point in the local NED system.

Data Types: double

lla0 — Origin of local NED system in geodetic coordinates

three-element row vector | n -by-3 matrix

Origin of the local NED system with the geodetic coordinates, specified as a three-element row vector or an n -by-3 matrix. n is the number of origin points. Specify each point in the form $[lat0\ lon0\ alt0]$. $lat0$ and $lon0$ specify the latitude and longitude respectively in degrees. $alt0$ specifies the altitude in meters.

Data Types: double

method — Transformation method

'flat' | 'ellipsoid'

Transformation method, specified as 'flat' or 'ellipsoid'. This argument specifies whether the function assumes the planet is flat or ellipsoidal.

The flat Earth transformation method has these limitations:

- Assumes that the flight path and bank angle are zero.
- Assumes that the flat Earth z -axis is normal to the Earth at only the initial geodetic latitude and longitude. This method has higher accuracy over small distances from the initial geodetic latitude and longitude, and closer to the equator. The method calculates a longitude with higher accuracy when the variation in latitude is smaller.
- Latitude values of +90 and -90 may return unexpected values because of singularity at the poles.

Data Types: char | string

Output Arguments

lla — Geodetic coordinates

three-element row vector | n -by-3 matrix

Geodetic coordinates, returned as a three-element row vector or an n -by-3 matrix. n is the number of transformed points. Each point is in the form $[lat\ lon\ alt]$. lat and lon specify the latitude and longitude, respectively, in degrees. alt specifies the altitude in meters.

Data Types: double

Extended Capabilities

C/C++ Code Generation

Generate C and C++ code using MATLAB® Coder™.

See Also

Functions

enu2lla | lla2enu | lla2ned

lla2enu

Transform geodetic coordinates to local east-north-up coordinates

Syntax

```
xyzENU = lla2enu(lla,lla0,method)
```

Description

`xyzENU = lla2enu(lla,lla0,method)` transforms the geodetic coordinates `lla` to local east-north-up (ENU) Cartesian coordinates `xyzENU`. Specify the origin of the local ENU system as the geodetic coordinates `lla0`.

Note

- The latitude and longitude values in the geodetic coordinate system use the World Geodetic System of 1984 (WGS84) standard.
 - Specify altitude as height in meters above the WGS84 reference ellipsoid.
-

Examples

Transform Geodetic Coordinates to ENU Coordinates

Specify the geodetic coordinates of the local origin in Zermatt, Switzerland.

```
lla0 = [46.017 7.750 1673]; % [lat0 lon0 alt0]
```

Specify the geodetic coordinates of a point of interest. In this case, the point of interest is the Matterhorn.

```
lla = [45.976 7.658 4531]; % [lat lon alt]
```

Transform the geodetic coordinates to local ENU coordinates using flat earth approximation.

```
xyzENU = lla2enu(lla,lla0,'flat')
```

```
xyzENU = 1×3  
103 ×
```

```
    -7.1244    -4.5572     2.8580
```

Input Arguments

lla — Geodetic coordinates

three-element row vector | n -by-3 matrix

Geodetic coordinates, specified as a three-element row vector or an n -by-3 matrix. n is the number of points to transform. Specify each point in the form `[lat lon alt]`. *lat* and *lon* specify the latitude and longitude respectively in degrees. *alt* specifies the altitude in meters.

Data Types: double

lla0 — Origin of local ENU system in geodetic coordinates

three-element row vector | n -by-3 matrix

Origin of the local ENU system in the geodetic coordinates, specified as a three-element row vector or an n -by-3 matrix. n is the number of origin points. Specify each point in the form `[lat0 lon0 alt0]`. *lat0* and *lon0* specify the latitude and longitude of the origin, respectively, in degrees. *alt0* specifies the altitude of the origin in meters.

Data Types: double

method — Transformation method

'flat' | 'ellipsoid'

Transformation method, specified as 'flat' or 'ellipsoid'. This argument specifies whether the function assumes the planet is flat or ellipsoidal.

The flat Earth transformation method has these limitations:

- Assumes that the flight path and bank angle are zero.
- Assumes that the flat Earth z -axis is normal to the Earth at only the initial geodetic latitude and longitude. This method has higher accuracy over small distances from the initial geodetic latitude and longitude, and closer to the equator. The method calculates a longitude with higher accuracy when the variation in latitude is smaller.
- Latitude values of +90 and -90 may return unexpected values because of singularity at the poles.

Data Types: char | string

Output Arguments

xyzENU — Local ENU Cartesian coordinates

three-element row vector | n -by-3 matrix

Local ENU Cartesian coordinates, returned as a three-element row vector or an n -by-3 matrix. n is the number of transformed points. Each point is in the form `[xEast yNorth zUp]`. *xEast*, *yNorth*, and *zUp* are the respective x -, y -, and z -coordinates, in meters, of the point in the local ENU system.

Data Types: double

Extended Capabilities

C/C++ Code Generation

Generate C and C++ code using MATLAB® Coder™.

See Also

Functions

enu2lla | lla2ned | ned2lla

lla2ned

Transform geodetic coordinates to local north-east-down coordinates

Syntax

```
xyzNED = lla2ned(lla,lla0,method)
```

Description

`xyzNED = lla2ned(lla,lla0,method)` transforms the geodetic coordinates `lla` to local north-east-down (NED) Cartesian coordinates `xyzNED`. Specify the origin of the local NED system as the geodetic coordinates `lla0`.

Note

- The latitude and longitude values in the geodetic coordinate system use the World Geodetic System of 1984 (WGS84) standard.
 - Specify altitude as height in meters above the WGS84 reference ellipsoid.
-

Examples

Transform Geodetic Coordinates to NED Coordinates

Specify the geodetic coordinates of the local origin in Zermatt, Switzerland.

```
lla0 = [46.017 7.750 1673]; % [lat0 lon0 alt0]
```

Specify the geodetic coordinates of a point of interest. In this case, the point of interest is the Matterhorn.

```
lla = [45.976 7.658 4531]; % [lat lon alt]
```

Transform the geodetic coordinates to local NED coordinates using flat earth approximation.

```
xyzNED = lla2ned(lla,lla0,'flat')
```

```
xyzNED = 1×3  
103 ×
```

```
    -4.5572    -7.1244    -2.8580
```

Input Arguments

lla — Geodetic coordinates

three-element row vector | n -by-3 matrix

Geodetic coordinates, specified as a three-element row vector or an n -by-3 matrix. n is the number of points to transform. Specify each point in the form `[lat lon alt]`. *lat* and *lon* specify the latitude and longitude respectively in degrees. *alt* specifies the altitude in meters.

Data Types: double

lla0 — Origin of local NED system in geodetic coordinates

three-element row vector | n -by-3 matrix

Origin of the local NED system with the geodetic coordinates, specified as a three-element row vector or an n -by-3 matrix. n is the number of origin points. Specify each point in the form `[lat0 lon0 alt0]`. *lat0* and *lon0* specify the latitude and longitude respectively in degrees. *alt0* specifies the altitude in meters.

Data Types: double

method — Transformation method

'flat' | 'ellipsoid'

Transformation method, specified as 'flat' or 'ellipsoid'. This argument specifies whether the function assumes the planet is flat or ellipsoidal.

The flat Earth transformation method has these limitations:

- Assumes that the flight path and bank angle are zero.
- Assumes that the flat Earth z -axis is normal to the Earth at only the initial geodetic latitude and longitude. This method has higher accuracy over small distances from the initial geodetic latitude and longitude, and closer to the equator. The method calculates a longitude with higher accuracy when the variation in latitude is smaller.
- Latitude values of +90 and -90 may return unexpected values because of singularity at the poles.

Data Types: char | string

Output Arguments

xyzNED — Local NED Cartesian coordinates

three-element row vector | n -by-3 matrix

Local NED Cartesian coordinates, returned as a three-element row vector or an n -by-3 matrix. n is the number of transformed points. Each point is in the form `[xNorth yEast zDown]`. *xNorth*, *yEast*, and *zDown* are the respective x -, y -, and z -coordinates, in meters, of the point in the local NED system.

Data Types: double

Extended Capabilities

C/C++ Code Generation

Generate C and C++ code using MATLAB® Coder™.

See Also

Functions

enu2lla | lla2enu | ned2lla

Classes

adsbCategory

Enumeration of Automatic Dependent Surveillance-Broadcast categories

Description

The `adsbCategory` enumeration class implements the list of categories used by the International Civil Aviation Organization (ICAO) and described in ICAO Document 9871.

Creation

Description

`cat = adsbCategory(category)` creates an `adsbCategory` enumeration object with the specified `category`. `category` argument must be a valid category name, specified as a character vector or a string scalar. For example, `adsbCategory('Obstacle')` creates an `Obstacle` category. For a list of valid category names, see ADS-B Categories and Category Indices.

`cat = adsbCategory(categoryIndex)` creates an `adsbCategory` enumeration object using the specified category index. A valid `categoryIndex` is an integer from 0 to 15. For details, see ADS-B Categories and Category Indices.

The table lists the valid `category` names and their corresponding `categoryIndex` values. The argument values in the same row result in equivalent `adsbCategory` object creation.

ADS-B Categories and Category Indices

Category Name	Category Index Value
No_Category_Information	0
Light	1
Small	2
Large	3
High_Vortex_Large	4
Heavy	5
High_Performance	6
Rotorcraft	7
Glider_Sailplane	8
Lighter_than_air	9
Parachutist_Skydiver	10
Ultralight	11
Unmanned_Aerial_Vehicle	12
Space_Vehicle	13
Surface_Vehicle	14
Obstacle	15

Examples

Create ADS-B Categories

Create a UAV category using its category name.

```
uavCat = adsbCategory('Unmanned_Aerial_Vehicle')
uavCat =
Unmanned_Aerial_Vehicle
```

Create a UAV category using its category index.

```
uavCatByIndex = adsbCategory(12)
uavCatByIndex =
Unmanned_Aerial_Vehicle
```

Extended Capabilities

C/C++ Code Generation

Generate C and C++ code using MATLAB® Coder™.

See Also

adsbReceiver | adsbTransponder

Introduced in R2021a

ahrs10filter

Height and orientation from MARG and altimeter readings

Description

The `ahrs10filter` object fuses MARG and altimeter sensor data to estimate device height and orientation. MARG (magnetic, angular rate, gravity) data is typically derived from magnetometer, gyroscope, and accelerometer sensors. The filter uses an 18-element state vector to track the orientation quaternion, vertical velocity, vertical position, MARG sensor biases, and geomagnetic vector. The `ahrs10filter` object uses an extended Kalman filter to estimate these quantities.

Creation

Syntax

```
FUSE = ahrs10filter
FUSE = ahrs10filter('ReferenceFrame', RF)
FUSE = ahrs10filter(___, Name, Value)
```

Description

`FUSE = ahrs10filter` returns an extended Kalman filter object, `FUSE`, for sensor fusion of MARG and altimeter readings to estimate device height and orientation.

`FUSE = ahrs10filter('ReferenceFrame', RF)` returns an extended Kalman filter object that estimates device height and orientation relative to the reference frame `RF`. Specify `RF` as `'NED'` (North-East-Down) or `'ENU'` (East-North-Up). The default value is `'NED'`.

`FUSE = ahrs10filter(___, Name, Value)` sets each property `Name` to the specified `Value`. Unspecified properties have default values.

Properties

IMUSampleRate — Sample rate of the IMU (Hz)

100 (default) | positive scalar

Sample rate of the IMU in Hz, specified as a positive scalar.

Data Types: `single` | `double`

GyroscopeNoise — Multiplicative process noise variance from gyroscope ((rad/s)²)

[1e-9, 1e-9, 1e-9] (default) | scalar | three-element row vector

Multiplicative process noise variance from the gyroscope in (rad/s)², specified as positive real finite numbers.

Data Types: `single` | `double`

AccelerometerNoise — Multiplicative process noise variance from accelerometer ((m/s²)²)
 [1e-4, 1e-4, 1e-4] (default) | scalar | three-element row vector

Multiplicative process noise variance from the accelerometer in (m/s²)², specified as positive real finite numbers.

Data Types: single | double

GyroscopeBiasNoise — Multiplicative process noise variance from gyroscope bias ((rad/s²)²)
 [1e-10, 1e-10, 1e-10] (default) | scalar | three-element row vector

Multiplicative process noise variance from the gyroscope bias in (rad/s²)², specified as positive real finite numbers.

Data Types: single | double

AccelerometerBiasNoise — Multiplicative process noise variance from accelerometer bias ((m/s²)²)
 [1e-4, 1e-4, 1e-4] (default) | scalar | three-element row vector

Multiplicative process noise variance from the accelerometer bias in (m/s²)², specified as positive real finite numbers.

Data Types: single | double

GeomagneticVectorNoise — Additive process noise for geomagnetic vector (μT²)
 [1e-6, 1e-6, 1e-6] (default) | scalar | three-element row vector

Additive process noise for geomagnetic vector in μT², specified as positive real finite numbers.

Data Types: single | double

MagnetometerBiasNoise — Additive process noise for magnetometer bias (μT²)
 [0.1, 0.1, 0.1] (default) | scalar | three-element row vector

Additive process noise for magnetometer bias in μT², specified as positive real finite numbers.

Data Types: single | double

State — State vector of extended Kalman filter

18-element column vector

State vector of the extended Kalman filter. The state values represent:

State	Units	Index
Orientation (quaternion parts)	N/A	1:4
Altitude (NED or ENU)	m	5
Vertical Velocity (NED or ENU)	m/s	6
Delta Angle Bias (XYZ)	rad/s	7:9
Delta Velocity Bias (XYZ)	m/s	10:12
Geomagnetic Field Vector (NED or ENU)	μT	13:15
Magnetometer Bias (XYZ)	μT	16:18

The default initial state corresponds to an object at rest located at $[0 \ 0 \ 0]$ in geodetic LLA coordinates.

Data Types: `single` | `double`

StateCovariance — State error covariance for extended Kalman filter

`eye(18)*1e-6` (default) | 18-by-18 matrix

State error covariance for the Kalman filter, specified as an 18-by-18-element matrix of real numbers.

Data Types: `single` | `double`

Object Functions

<code>predict</code>	Update states using accelerometer and gyroscope data for <code>ahrs10filter</code>
<code>fusemag</code>	Correct states using magnetometer data for <code>ahrs10filter</code>
<code>fusealtimeter</code>	Correct states using altimeter data for <code>ahrs10filter</code>
<code>correct</code>	Correct states using direct state measurements for <code>ahrs10filter</code>
<code>residual</code>	Residuals and residual covariances from direct state measurements for <code>ahrs10filter</code>
<code>residualmag</code>	Residuals and residual covariance from magnetometer measurements for <code>ahrs10filter</code>
<code>residualaltimeter</code>	Residuals and residual covariance from altimeter measurements for <code>ahrs10filter</code>
<code>pose</code>	Current orientation and position estimate for <code>ahrs10filter</code>
<code>reset</code>	Reset internal states for <code>ahrs10filter</code>
<code>stateinfo</code>	Display state vector information for <code>ahrs10filter</code>
<code>tune</code>	Tune <code>ahrs10filter</code> parameters to reduce estimation error
<code>copy</code>	Create copy of <code>ahrs10filter</code>

Examples

Estimate Pose of UAV

Load logged sensor data, ground truth pose, and initial state and initial state covariance. Calculate the number of IMU samples per altimeter sample and the number of IMU samples per magnetometer sample.

```
load('fuse10exampledata.mat', ...
     'imuFs','accelData','gyroData', ...
     'magnetometerFs','magData', ...
     'altimeterFs','altData', ...
     'expectedHeight','expectedOrient', ...
     'initstate','initcov');
```

```
imuSamplesPerAlt = fix(imuFs/altimeterFs);
imuSamplesPerMag = fix(imuFs/magnetometerFs);
```

Create an AHRS filter that fuses MARG and altimeter readings to estimate height and orientation. Set the sampling rate and measurement noises of the sensors. The values were determined from datasheets and experimentation.

```
filt = ahrs10filter('IMUSampleRate',imuFs, ...
                  'AccelerometerNoise',0.1, ...
                  'State',initstate, ...
                  'StateCovariance',initcov);
```

```
Ralt = 0.24;
Rmag = 0.9;
```

Preallocate variables to log height and orientation.

```
numIMUSamples = size(accelData,1);
estHeight = zeros(numIMUSamples,1);
estOrient = zeros(numIMUSamples,1,'quaternion');
```

Fuse accelerometer, gyroscope, magnetometer and altimeter data. The outer loop predicts the filter forward at the fastest sample rate (the IMU sample rate).

```
for ii = 1:numIMUSamples

    % Use predict to estimate the filter state based on the accelerometer and
    % gyroscope data.
    predict(filt,accelData(ii,:),gyroData(ii,:));

    % Magnetometer data is collected at a lower rate than IMU data. Fuse
    % magnetometer data at the lower rate.
    if ~mod(ii,imuSamplesPerMag)
        fusemag(filt,magData(ii,:),Rmag);
    end

    % Altimeter data is collected at a lower rate than IMU data. Fuse
    % altimeter data at the lower rate.
    if ~mod(ii,imuSamplesPerAlt)
        fusealtimeter(filt,altData(ii),Ralt);
    end

    % Log the current height and orientation estimate.
    [estHeight(ii),estOrient(ii)] = pose(filt);
end
```

Calculate the RMS errors between the known true height and orientation and the output from the AHRS filter.

```
pErr = expectedHeight - estHeight;
qErr = rad2deg(dist(expectedOrient,estOrient));
```

```
pRMS = sqrt(mean(pErr.^2));
qRMS = sqrt(mean(qErr.^2));
```

```
fprintf('Altitude RMS Error\n');
```

```
Altitude RMS Error
```

```
fprintf('\t%.2f (meters)\n\n',pRMS);
```

```
    0.38 (meters)
```

Visualize the true and estimated height over time.

```
t = (0:(numIMUSamples-1))/imuFs;
plot(t,expectedHeight);hold on
plot(t,estHeight);hold off
legend('Ground Truth','Estimated Height','location','best')
ylabel('Height (m)')
```

```
xlabel('Time (s)')
grid on
```

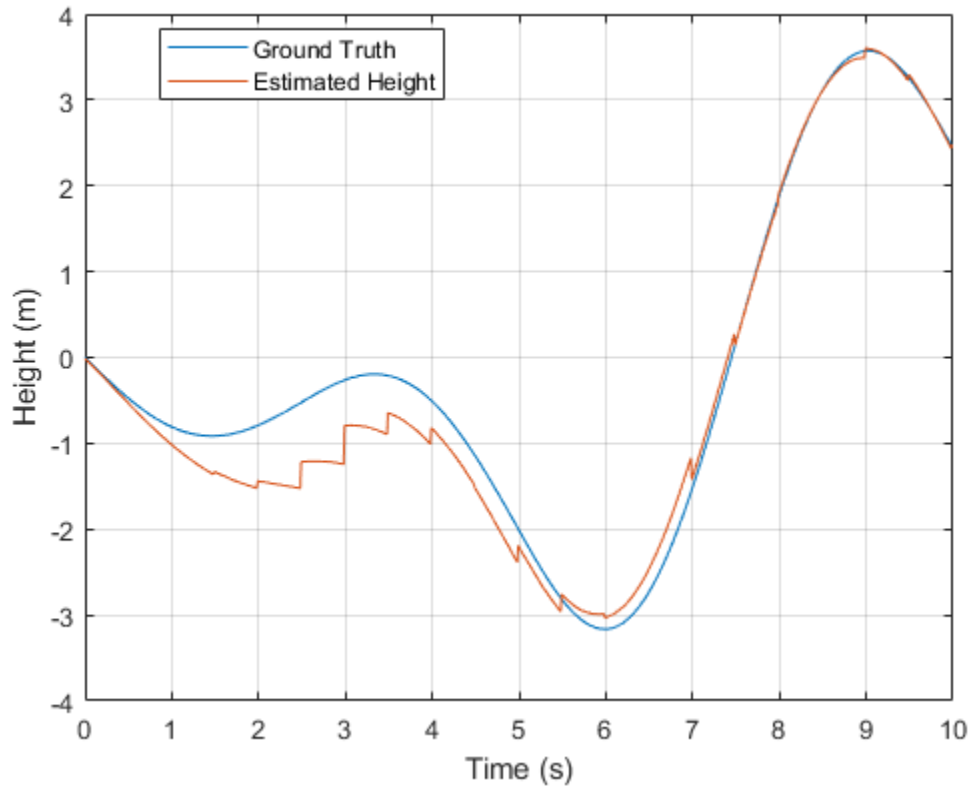

```
fprintf('Quaternion Distance RMS Error\n');
```

```
Quaternion Distance RMS Error
```

```
fprintf('\t%.2f (degrees)\n\n', qRMS);
```

```
2.93 (degrees)
```

Extended Capabilities

C/C++ Code Generation

Generate C and C++ code using MATLAB® Coder™.

See Also

ahrsfilter | insfilter

Introduced in R2019a

copy

Create copy of `ahrs10filter`

Syntax

```
newFilter = copy(filter)
```

Description

`newFilter = copy(filter)` returns a copy of the `ahrs10filter`, `filter`, with the exactly same property values.

Input Arguments

filter — Filter to be copied

`ahrs10filter`

Filter to be copied, specified as an `ahrs10filter` object.

Output Arguments

newFilter — New copied filter

`ahrs10filter`

New copied filter, returned as an `ahrs10filter` object.

See Also

`ahrs10filter`

Introduced in R2020b

reset

Reset internal states for `ahrs10filter`

Syntax

```
reset(FUSE)
```

Description

`reset(FUSE)` resets the `State`, `StateCovariance`, and internal integrators to their default values.

Input Arguments

FUSE — `ahrs10filter` object

object

Object of `ahrs10filter`.

Extended Capabilities

C/C++ Code Generation

Generate C and C++ code using MATLAB® Coder™.

See Also

`ahrs10filter` | `insfilter`

Introduced in R2019a

predict

Update states using accelerometer and gyroscope data for `ahrs10filter`

Syntax

```
predict(FUSE, accelReadings, gyroReadings)
```

Description

`predict(FUSE, accelReadings, gyroReadings)` fuses accelerometer and gyroscope data to update the state estimate.

Input Arguments

FUSE — `ahrs10Filter` object

object

Object of `ahrs10filter`.

accelReadings — Accelerometer readings in the sensor body coordinate system (m/s²)

N-by-3 matrix

Accelerometer readings in local sensor body coordinate system in m/s², specified as an *N*-by-3 matrix. *N* is the number of samples, and the three columns of `accelReadings` represent the [*x y z*] measurements. Accelerometer readings are assumed to correspond to the sample rate specified by the `IMUSampleRate` property.

Data Types: `single` | `double`

gyroReadings — Gyroscope readings in the sensor body coordinate system (rad/s)

N-by-3 matrix

Gyroscope readings in the sensor body coordinate system in rad/s, specified as an *N*-by-3 matrix. *N* is the number of samples, and the three columns of `gyroReadings` represent the [*x y z*] measurements. Gyroscope readings are assumed to correspond to the sample rate specified by the `IMUSampleRate` property.

Data Types: `single` | `double`

Extended Capabilities

C/C++ Code Generation

Generate C and C++ code using MATLAB® Coder™.

See Also

`ahrs10filter` | `insfilter`

Introduced in R2019a

pose

Current orientation and position estimate for `ahrs10filter`

Syntax

```
[position, orientation, velocity] = pose(FUSE)
[position, orientation, velocity] = pose(FUSE, format)
```

Description

`[position, orientation, velocity] = pose(FUSE)` returns the current estimate of the pose.

`[position, orientation, velocity] = pose(FUSE, format)` returns the current estimate of the pose with orientation in the specified orientation format.

Input Arguments

FUSE — `ahrs10filter` object

object

Object of `ahrs10filter`.

format — Output orientation format

'quaternion' (default) | 'rotmat'

Output orientation format, specified as either 'quaternion' for a quaternion or 'rotmat' for a rotation matrix.

Data Types: char | string

Output Arguments

position — Vertical position estimate in the local NED coordinate system (m)

scalar

Vertical position estimate in the local NED coordinate system in meters, returned as a scalar.

Data Types: single | double

orientation — Orientation estimate in the local NED coordinate system

quaternion (default) | 3-by-3 rotation matrix

Orientation estimate in the local NED coordinate system, returned as a scalar quaternion or 3-by-3 rotation matrix. The quaternion or rotation matrix represents a frame rotation from the local NED reference frame to the body reference frame.

Data Types: single | double | quaternion

velocity — Vertical velocity estimate in the local NED coordinate system (m/s)

scalar

Vertical velocity estimate in the local NED coordinate system in m/s, returned as a scalar.

Data Types: `single` | `double`

Extended Capabilities

C/C++ Code Generation

Generate C and C++ code using MATLAB® Coder™.

See Also

`ahrs10filter` | `insfilter`

Introduced in R2019a

fusemag

Correct states using magnetometer data for `ahrs10filter`

Syntax

```
[res,resCov] = fusemag(FUSE,magReadings,magReadingsCovariance)
```

Description

`[res,resCov] = fusemag(FUSE,magReadings,magReadingsCovariance)` fuses magnetometer data to correct the state estimate.

Input Arguments

FUSE — ahrs10filter object

object

Object of `ahrs10filter`.

magReadings — Magnetometer readings (μT)

3-element row vector

Magnetometer readings in μT , specified as a 3-element row vector of finite real numbers.

Data Types: `single` | `double`

magReadingsCovariance — Magnetometer readings error covariance (μT^2)

scalar | 3-element row vector | 3-by-3 matrix

Magnetometer readings error covariance in μT^2 , specified as a scalar, 3-element row vector, or 3-by-3 matrix.

Data Types: `single` | `double`

res — Residual

1-by-3 vector of real values

Residual, returned as a 1-by-3 vector of real values in μT .

Data Types: `single` | `double`

resCov — Residual covariance

3-by-3 matrix of real values

Residual covariance, returned a 3-by-3 matrix of real values in $(\mu\text{T})^2$.

Extended Capabilities

C/C++ Code Generation

Generate C and C++ code using MATLAB® Coder™.

See Also

`ahrs10filter` | `insfilter`

Introduced in R2019a

residualmag

Residuals and residual covariance from magnetometer measurements for `ahrs10filter`

Syntax

```
[res,resCov] = residualmag(FUSE,magReadings,magReadingsCovariance)
```

Description

`[res,resCov] = residualmag(FUSE,magReadings,magReadingsCovariance)` computes the residual, `residual`, and the residual covariance, `resCov`, based on the magnetometer readings and the corresponding covariance.

Input Arguments

FUSE — ahrs10filter

`ahrs10filter` | object

`ahrs10filter`, specified as an object.

magReadings — Magnetometer readings (μT)

3-element row vector

Magnetometer readings in μT , specified as a 3-element row vector of finite real numbers.

Data Types: `single` | `double`

magReadingsCovariance — Magnetometer readings error covariance (μT^2)

scalar | 3-element row vector | 3-by-3 matrix

Magnetometer readings error covariance in μT^2 , specified as a scalar, 3-element row vector, or 3-by-3 matrix.

Data Types: `single` | `double`

Output Arguments

res — Residual

1-by-3 vector of real values

Residual, returned as a 1-by-3 vector of real values in μT .

Data Types: `single` | `double`

resCov — Residual covariance

3-by-3 matrix of real values

Residual covariance, returned a 3-by-3 matrix of real values in $(\mu\text{T})^2$.

Extended Capabilities

C/C++ Code Generation

Generate C and C++ code using MATLAB® Coder™.

See Also

`ahrs10filter`

Introduced in R2020a

tune

Tune `ahrs10filter` parameters to reduce estimation error

Syntax

```
tunedMeasureNoise = tune(filter,measureNoise,sensorData,groundTruth)
tunedMeasureNoise = tune( __ ,config)
```

Description

`tunedMeasureNoise = tune(filter,measureNoise,sensorData,groundTruth)` adjusts the properties of the `ahrs10filter` filter object, `filter`, and measurement noises to reduce the root-mean-squared (RMS) state estimation error between the fused sensor data and the ground truth. The function also returns the tuned measurement noise, `tunedMeasureNoise`. The function uses the property values in the filter and the measurement noise provided in the `measureNoise` structure as the initial estimate for the optimization algorithm.

`tunedMeasureNoise = tune(__ ,config)` specifies the tuning configuration based on a `tunerconfig` object, `config`.

Examples

Tune `ahrs10filter` to Optimize Pose Estimate

Load the recorded sensor data and ground truth data.

```
load('ahrs10filterTuneData.mat');
```

Create tables for the sensor data and the truth data.

```
sensorData = table(Accelerometer,Gyroscope,...
    Magnetometer,Altimeter);
groundTruth = table(Orientation, Altitude);
```

Create an `ahrs10filter` filter object.

```
filter = ahrs10filter('State', initialState, ...
    'StateCovariance', initialStateCovariance);
```

Create a tuner configuration object for the filter. Set the maximum iterations to ten and set the objective limit to 0.001.

```
cfg = tunerconfig('ahrs10filter','MaxIterations',10,...
    'ObjectiveLimit',1e-3);
```

Use the tuner noise function to obtain a set of initial sensor noises used in the filter.

```
measNoise = tunernoise('ahrs10filter')
```

```
measNoise = struct with fields:
    MagnetometerNoise: 1
```

```
AltimeterNoise: 1
```

Tune the filter and obtain the tuned parameters.

```
tunedNoise = tune(filter, measNoise, sensorData, ...
    groundTruth, cfg);
```

Iteration	Parameter	Metric
1	AccelerometerNoise	0.0526
1	GyroscopeNoise	0.0526
1	MagnetometerNoise	0.0523
1	AltimeterNoise	0.0515
1	AccelerometerBiasNoise	0.0510
1	GyroscopeBiasNoise	0.0510
1	GeomagneticVectorNoise	0.0510
1	MagnetometerBiasNoise	0.0508
2	AccelerometerNoise	0.0508
2	GyroscopeNoise	0.0508
2	MagnetometerNoise	0.0504
2	AltimeterNoise	0.0494
2	AccelerometerBiasNoise	0.0490
2	GyroscopeBiasNoise	0.0490
2	GeomagneticVectorNoise	0.0490
2	MagnetometerBiasNoise	0.0487
3	AccelerometerNoise	0.0487
3	GyroscopeNoise	0.0487
3	MagnetometerNoise	0.0482
3	AltimeterNoise	0.0472
3	AccelerometerBiasNoise	0.0467
3	GyroscopeBiasNoise	0.0467
3	GeomagneticVectorNoise	0.0467
3	MagnetometerBiasNoise	0.0463
4	AccelerometerNoise	0.0463
4	GyroscopeNoise	0.0463
4	MagnetometerNoise	0.0456
4	AltimeterNoise	0.0446
4	AccelerometerBiasNoise	0.0442
4	GyroscopeBiasNoise	0.0442
4	GeomagneticVectorNoise	0.0442
4	MagnetometerBiasNoise	0.0437
5	AccelerometerNoise	0.0437
5	GyroscopeNoise	0.0437
5	MagnetometerNoise	0.0428
5	AltimeterNoise	0.0417
5	AccelerometerBiasNoise	0.0413
5	GyroscopeBiasNoise	0.0413
5	GeomagneticVectorNoise	0.0413
5	MagnetometerBiasNoise	0.0408
6	AccelerometerNoise	0.0408
6	GyroscopeNoise	0.0408
6	MagnetometerNoise	0.0397
6	AltimeterNoise	0.0385
6	AccelerometerBiasNoise	0.0381
6	GyroscopeBiasNoise	0.0381
6	GeomagneticVectorNoise	0.0381
6	MagnetometerBiasNoise	0.0375

7	AccelerometerNoise	0.0375
7	GyroscopeNoise	0.0375
7	MagnetometerNoise	0.0363
7	AltimeterNoise	0.0351
7	AccelerometerBiasNoise	0.0347
7	GyroscopeBiasNoise	0.0347
7	GeomagneticVectorNoise	0.0347
7	MagnetometerBiasNoise	0.0342
8	AccelerometerNoise	0.0342
8	GyroscopeNoise	0.0342
8	MagnetometerNoise	0.0331
8	AltimeterNoise	0.0319
8	AccelerometerBiasNoise	0.0316
8	GyroscopeBiasNoise	0.0316
8	GeomagneticVectorNoise	0.0316
8	MagnetometerBiasNoise	0.0313
9	AccelerometerNoise	0.0313
9	GyroscopeNoise	0.0313
9	MagnetometerNoise	0.0313
9	AltimeterNoise	0.0301
9	AccelerometerBiasNoise	0.0298
9	GyroscopeBiasNoise	0.0298
9	GeomagneticVectorNoise	0.0298
9	MagnetometerBiasNoise	0.0296
10	AccelerometerNoise	0.0296
10	GyroscopeNoise	0.0296
10	MagnetometerNoise	0.0296
10	AltimeterNoise	0.0285
10	AccelerometerBiasNoise	0.0283
10	GyroscopeBiasNoise	0.0283
10	GeomagneticVectorNoise	0.0283
10	MagnetometerBiasNoise	0.0282

Fuse the sensor data using the tuned filter.

```

N = size(sensorData,1);
qEstTuned = quaternion.zeros(N,1);
altEstTuned = zeros(N,1);
for ii=1:N
    predict(filter,Accelerometer(ii,:),Gyroscope(ii,:));
    if all(~isnan(Magnetometer(ii,1)))
        fusemag(filter, Magnetometer(ii,:),tunedNoise.MagnetometerNoise);
    end
    if ~isnan(Altimeter(ii))
        fusealtimeter(filter, Altimeter(ii),tunedNoise.AltimeterNoise);
    end
    [altEstTuned(ii), qEstTuned(ii)] = pose(filter);
end

```

Compute the RMS errors.

```

orientationErrorTuned = rad2deg(dist(qEstTuned, Orientation));
rmsOrientationErrorTuned = sqrt(mean(orientationErrorTuned.^2))

rmsOrientationErrorTuned = 2.2899

positionErrorTuned = altEstTuned - Altitude;
rmsPositionErrorTuned = sqrt(mean( positionErrorTuned.^2))

```

```
rmsPositionErrorTuned = 0.0199
```

Visualize the results.

```
figure;
t = (0:N-1)./ filter.IMUSampleRate;
subplot(2,1,1)
plot(t, positionErrorTuned, 'b');
title("Tuned ahrs10filter" + newline + ...
      "Altitude Error")
xlabel('Time (s)');
ylabel('Position Error (meters)')
subplot(2,1,2)
plot(t, orientationErrorTuned, 'b');
title("Orientation Error")
xlabel('Time (s)');
ylabel('Orientation Error (degrees)');
```

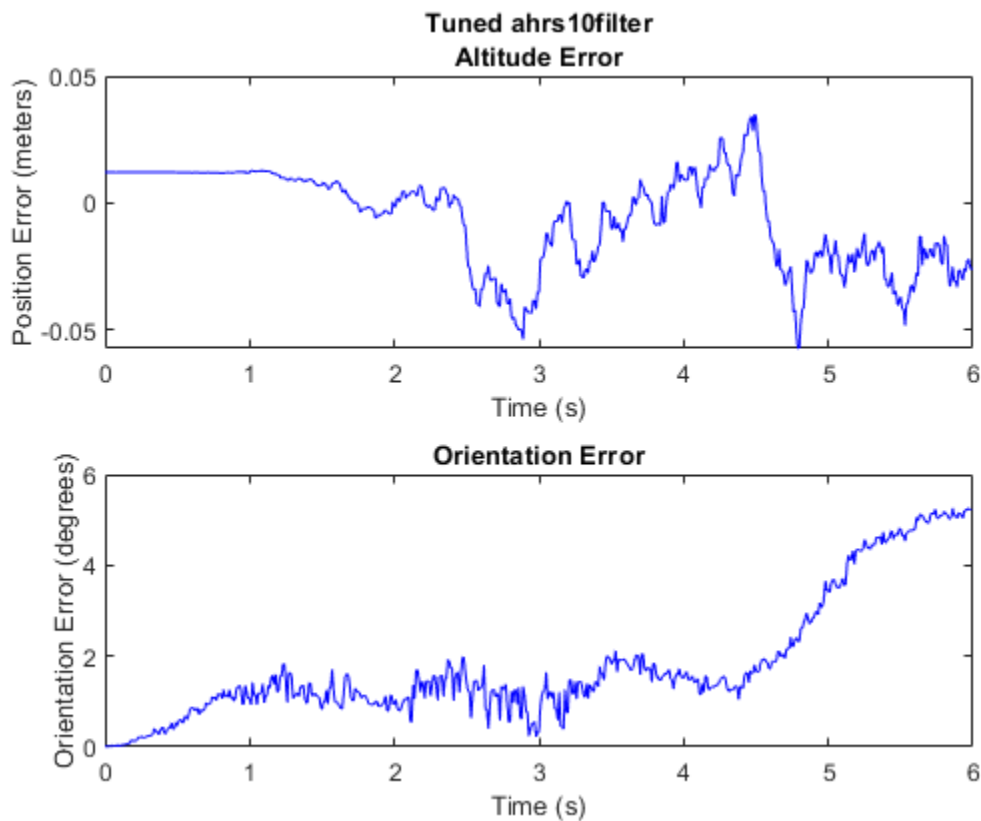

Input Arguments

filter – Filter object

ahrs10filter object

Filter object, specified as an ahrs10filter object.

measureNoise — Measurement noise

structure

Measurement noise, specified as a structure. The function uses the measurement noise input as the initial guess for tuning the measurement noise. The structure must contain these fields:

Field name	Description
MagnetometerNoise	Variance of magnetometer noise, specified as a scalar in $(\mu\text{T})^2$
AltimeterNoise	Variance of altimeter noise, specified as a scalar in m^2

sensorData — Sensor data

table

Sensor data, specified as a table. In each row, the sensor data is specified as:

- **Accelerometer** — Accelerometer data, specified as a 1-by-3 vector of scalars in m^2/s .
- **Gyroscope**— Gyroscope data, specified as a 1-by-3 vector of scalars in rad/s .
- **Magnetometer** — Magnetometer data, specified as a 1-by-3 vector of scalars in μT .
- **Altimeter** — Altimeter data, specified as a scalar in meters.

If the magnetometer does not produce measurements, specify the corresponding entry as NaN. If you set the `Cost` property of the tuner configuration input, `config`, to `Custom`, then you can use other data types for the `sensorData` input based on your choice.

groundTruth — Ground truth data

table

Ground truth data, specified as a table. In each row, the table can optionally contain any of these variables:

- **Orientation** — Orientation from the navigation frame to the body frame, specified as a quaternion or a 3-by-3 rotation matrix.
- **Altitude** — Altitude, specified as a scalar in meters.
- **VerticalVelocity** — Velocity in the vertical direction, specified as a scalar in m/s .
- **DeltaAngleBias** — Delta angle bias, specified as a 1-by-3 vector of scalars in radians.
- **DeltaVelocityBias** — Delta velocity bias, specified as a 1-by-3 vector of scalars in m/s .
- **GeomagneticFieldVector** — Geomagnetic field vector in navigation frame, specified as a 1-by-3 vector of scalars.
- **MagnetometerBias** — Magnetometer bias in body frame, specified as a 1-by-3 vector of scalars in μT .

The function processes each row of the `sensorData` and `groundTruth` tables sequentially to calculate the state estimate and RMS error from the ground truth. State variables not present in `groundTruth` input are ignored for the comparison. The `sensorData` and the `groundTruth` tables must have the same number of rows.

If you set the `Cost` property of the tuner configuration input, `config`, to `Custom`, then you can use other data types for the `groundTruth` input based on your choice.

config – Tuner configuration

tunerconfig object

Tuner configuration, specified as a tunerconfig object.

Output Arguments**tunedMeasureNoise – Tuned measurement noise**

structure

Tuned measurement noise, returned as a structure. The structure contains these fields.

Field name	Description
MagnetometerNoise	Variance of magnetometer noise, specified as a scalar in $(\mu\text{T})^2$
AltimeterNoise	Variance of altimeter noise, specified as a scalar in m^2

References

[1] Abbeel, P., Coates, A., Montemerlo, M., Ng, A.Y. and Thrun, S. Discriminative Training of Kalman Filters. In *Robotics: Science and systems*, Vol. 2, pp. 1, 2005.

See Also

tunerconfig | tunernoise

Introduced in R2021a

fusealtimeter

Correct states using altimeter data for `ahrs10filter`

Syntax

```
[res,resCov] = fusealtimeter(FUSE,altimeterReadings,  
altimeterReadingsCovariance)
```

Description

```
[res,resCov] = fusealtimeter(FUSE,altimeterReadings,  
altimeterReadingsCovariance) fuses altimeter data to correct the state estimate.
```

Input Arguments

FUSE — ahrs10filter object

object

Object of `ahrs10filter`.

altimeterReadings — Altimeter readings (m)

real scalar

Altimeter readings in meters, specified as a real scalar.

Data Types: `single` | `double`

altimeterReadingsCovariance — Altimeter readings error covariance (m²)

real scalar

Altimeter readings error covariance in m², specified as a real scalar.

Data Types: `single` | `double`

Output Arguments

res — Measurement residual

scalar

Measurement residual, returned as a scalar in meters.

resCov — Residual covariance

nonnegative scalar

Residual covariance, returned as a nonnegative scalar in m².

Extended Capabilities

C/C++ Code Generation

Generate C and C++ code using MATLAB® Coder™.

See Also

`ahrs10filter` | `insfilter`

Introduced in R2019a

residualaltimeter

Residuals and residual covariance from altimeter measurements for `ahrs10filter`

Syntax

```
[res,resCov] = residualaltimeter(FUSE,altimeterReadings,  
altimeterReadingsCovariance)
```

Description

`[res,resCov] = residualaltimeter(FUSE,altimeterReadings, altimeterReadingsCovariance)` computes the residual, `res`, and the innovation covariance, `resCov`, based on the magnetometer readings and the corresponding covariance.

Input Arguments

FUSE — ahrs10filter

`ahrs10filter` | object

`ahrs10filter`, specified as an object.

altimeterReadings — Altimeter readings (m)

real scalar

Altimeter readings in meters, specified as a real scalar.

Data Types: `single` | `double`

altimeterReadingsCovariance — Altimeter readings error covariance (m²)

real scalar

Altimeter readings error covariance in m², specified as a real scalar.

Data Types: `single` | `double`

Output Arguments

res — Measurement residual

scalar

Measurement residual, returned as a scalar in meters.

resCov — Residual covariance

nonnegative scalar

Residual covariance, returned as a nonnegative scalar in m².

Extended Capabilities

C/C++ Code Generation

Generate C and C++ code using MATLAB® Coder™.

See Also

`ahrs10filter` | `insfilter`

Introduced in R2020a

correct

Correct states using direct state measurements for `ahrs10filter`

Syntax

```
correct(FUSE, idx, measurement, measurementCovariance)
```

Description

`correct(FUSE, idx, measurement, measurementCovariance)` corrects the state and state estimation error covariance based on the measurement and measurement covariance. The measurement maps directly to the state specified by the indices `idx`.

Input Arguments

FUSE — `ahrs10filter` object

object

Object of `ahrs10filter`.

idx — State vector index of measurement to correct

N -element vector of increasing integers in the range [1,18]

State vector index of measurement to correct, specified as an N -element vector of increasing integers in the range [1,18].

The state values represent:

State	Units	Index
Orientation (quaternion parts)	N/A	1:4
Altitude (NED)	m	5
Vertical Velocity (NED)	m/s	6
Delta Angle Bias (XYZ)	rad/s	7:9
Delta Velocity Bias (XYZ)	m/s	10:12
Geomagnetic Field Vector (NED)	μT	13:15
Magnetometer Bias (XYZ)	μT	16:18

Data Types: `single` | `double`

measurement — Direct measurement of state

N -element vector

Direct measurement of state, specified as a N -element vector. N is the number of elements of the index argument, `idx`.

Data Types: `single` | `double`

measurementCovariance — Covariance of measurementscalar | N -element vector | N -by- N matrix

Covariance of measurement, specified as a scalar, N -element vector, or N -by- N matrix. N is the number of elements of the index argument, `idx`.

Data Types: `single` | `double`**Extended Capabilities****C/C++ Code Generation**

Generate C and C++ code using MATLAB® Coder™.

See Also`ahrs10filter` | `insfilter`**Introduced in R2019a**

stateinfo

Display state vector information for `ahrs10filter`

Syntax

```
stateinfo(FUSE)
info = stateinfo(FUSE)
```

Description

`stateinfo(FUSE)` displays the meaning of each index of the State property and the associated units.

`info = stateinfo(FUSE)` returns a structure with fields containing descriptions of the elements of the state vector of the filter, FUSE.

Examples

State information of `ahrs10filter`

Create an `ahrs10filter` object.

```
filter = ahrs10filter;
```

Display the state information of the created filter.

```
stateinfo(filter)

States                Units    Index
Orientation (quaternion parts)
Altitude (NAV)        m        5
Vertical Velocity (NAV) m/s      6
Delta Angle Bias (XYZ) rad       7:9
Delta Velocity Bias (XYZ) m/s     10:12
Geomagnetic Field Vector (NAV)  $\mu$ T    13:15
Magnetometer Bias (XYZ)  $\mu$ T    16:18
```

Output the state information of the filter as a structure.

```
info = stateinfo(filter)

info = struct with fields:
    Orientation: [1 2 3 4]
    Altitude: 5
    VerticalVelocity: 6
    DeltaAngleBias: [7 8 9]
    DeltaVelocityBias: [10 11 12]
    GeomagneticFieldVector: [13 14 15]
    MagnetometerBias: [16 17 18]
```

Input Arguments

FUSE — `ahrs10filter` object
object

Object of `ahrs10filter`.

Output Arguments

info — State information
structure

State information, returned as a structure with fields containing descriptions of the elements of the state vector of the filter. The values of each field are the corresponding indices of the state vector.

Extended Capabilities

C/C++ Code Generation

Generate C and C++ code using MATLAB® Coder™.

See Also

`ahrs10filter` | `insfilter`

Introduced in R2019a

residual

Residuals and residual covariances from direct state measurements for `ahrs10filter`

Syntax

```
[res, resCov]= residual(FUSE,idx,measurement,measurementCovariance)
```

Description

`[res, resCov]= residual(FUSE,idx,measurement,measurementCovariance)` computes the residual, `res`, and the residual covariance, `resCov`, based on the direct state measurement and measurement covariance. The measurement maps directly to the states specified by indices, `idx`.

Input Arguments

FUSE — ahrs10filter

`ahrs10filter` | object

`ahrs10filter`, specified as an object.

idx — State vector index of measurement to correct

N -element vector of increasing integers in the range [1,18]

State vector index of measurement to correct, specified as an N -element vector of increasing integers in the range [1,18].

The state values represent:

State	Units	Index
Orientation (quaternion parts)	N/A	1:4
Altitude (NED)	m	5
Vertical Velocity (NED)	m/s	6
Delta Angle Bias (XYZ)	rad/s	7:9
Delta Velocity Bias (XYZ)	m/s	10:12
Geomagnetic Field Vector (NED)	μT	13:15
Magnetometer Bias (XYZ)	μT	16:18

measurement — Direct measurement of state

N -element vector

Direct measurement of state, specified as a N -element vector. N is the number of elements of the index argument, `idx`.

measurementCovariance — Covariance of measurement

N -by- N matrix

Covariance of measurement, specified as an N -by- N matrix. N is the number of elements of the index argument, `idx`.

Output Arguments

res — Measurement residual

1-by- N vector of real values

Measurement residual, returned as a 1-by- N vector of real values.

resCov — Residual covariance

N -by- N matrix of real values

Residual covariance, returned as a N -by- N matrix of real values.

Extended Capabilities

C/C++ Code Generation

Generate C and C++ code using MATLAB® Coder™.

See Also

`ahrs10filter`

Introduced in R2020a

trackingSensorConfiguration

Represent sensor configuration for tracking

Description

The `trackingSensorConfiguration` object creates the configuration for a sensor used with a `trackerPHD System` object™. It allows you to specify the sensor parameters such as clutter density, sensor limits, sensor resolution. You can also specify how a tracker perceives the detections from the sensor using properties such as `FilterInitializationFcn`, `SensorTransformFcn`, and `SensorTransformParameters`. See “Create a Tracking Sensor Configuration” on page 2-41 for more details. The `trackingSensorConfiguration` object enables the tracker to perform three main routine operations:

- Evaluate the probability of detection at points in state-space.
- Initiate components in the probability hypothesis density.
- Obtain the clutter density of the sensor.

Creation

Syntax

```
config = trackingSensorConfiguration(SensorIndex)
config = trackingSensorConfiguration(SensorIndex,Name,Value)
```

Description

`config = trackingSensorConfiguration(SensorIndex)` creates a `trackingSensorConfiguration` object with a specified sensor index, `SensorIndex`, and default property values.

`config = trackingSensorConfiguration(SensorIndex,Name,Value)` allows you to set properties using one or more name-value pairs.

Properties

SensorIndex — Unique sensor identifier

positive integer

Unique sensor identifier, specified as a positive integer. This property distinguishes detections that come from different sensors in a multi-sensor system. When creating a `trackingSensorConfiguration` object, you must specify the `SensorIndex` as the first input argument in the creation syntax.

Example: 2

Data Types: double

IsValidTime — Indicate detection reporting status

false (default) | true

Indicate the detection reporting status of the sensor, specified as `false` or `true`. Set this property to `true` when the sensor must report detections within its sensor limits to the tracker. If a track or target was supposed to be detected by a sensor but the sensor reported no detections, then this information is used to count against the probability of existence of the track when the `IsValidTime` property is set to `true`.

Data Types: logical

FilterInitializationFcn — Filter initialization function

@initcvggiwphd (default) | function handle | character vector

Filter initialization function, specified as a function handle or as a character vector containing the name of a valid filter initialization function. The function initializes the PHD filter used by `trackerPHD`. The function must support the following syntaxes:

```
filter = filterInitializationFcn()
filter = filterInitializationFcn(detections)
```

`filter` is a valid PHD filter with components for new-born targets, and `detections` is a cell array of `objectDetection` objects. The first syntax allows you to specify the predictive birth density in the PHD filter without using detections. The second syntax allows the filter to initialize the adaptive birth density using detection information. See the “BirthRate” on page 3-0 property of `trackerPHD` for more details. If you create your own `FilterInitializationFcn`, you must also provide a transform function using the `SensorTransformFcn` property. Other than the default filter initialization function `initcvggiwphd`, Sensor Fusion and Tracking Toolbox also provides other initialization functions, such as `initctrectgmphd`, `initctgmphd`, `initcvgmphd`, `initcagmphd`, `initctggiwphd` and `initcaggiwphd`.

Data Types: function_handle | char

SensorTransformFcn — Sensor transform function

@cvmeas | function handle | character vector

Sensor transform function, specified as a function handle or as a character vector containing the name of a valid sensor transform function. The function transforms a track's state into the sensor's detection state. For example, the function transforms the track's state in the scenario Cartesian frame to the sensor's spherical frame. You can create your own sensor transform function, but it must support the following syntax:

```
detStates = SensorTransformFcn(trackStates,params)
```

`params` are the parameters stored in the `SensorTransformParameters` property. Notice that the signature of the function is similar to a measurement function. Therefore, you can use a measurement function (such as `cvmeas`, `ctmeas`, or `cameas`) as the `SensorTransformFcn`.

Depending on the filter type and the target type, the output, `detStates`, needs to return differently.

- When used with `gmphd` for non-extended targets or with `ggiwphd`, `detStates` is a N -by- M matrix, where N is the number of rows in the `SensorLimits` property and M is the number of input states in `trackStates`. For `gmphd`, non-extended targets refer to point targets and extended targets whose `MeasurementOrigin` is 'center'.
- When used with `gmphd` for extended targets, the `SensorTransformFcn` allows you to specify multiple `detStates` per `trackState`. In this case, `detStates` is a N -by- M -by- S matrix, where S

is the number of detectable sources on the extended target. For example, if the target is described by a rectangular state, the detectable sources can be the corners of the rectangle.

If any of the source falls inside the `SensorLimits`, the target is declared detectable. The functions uses the spread (maximum coordinate – minimum coordinate) of each `detStates` and the ratio between the spread and sensor resolution on each sensor limit to calculate the expected number of detections from each extended target. You can override this default setting by providing an optional output in the `SensorTransformFcn` as:

```
[..., Nexpt] = SensorTransformFcn(trackStates, params)
```

where `Nexpt` is the expected number of detections from each extended track state.

Note that the default `SensorTransformFcn` is the sensor transform function of the filter returned by `FilterInitializationFcn`. For example, the `initicvvggiwphd` function returns the default `cvmeas`, whereas `initictggiwphd` and `initicaggiwphd` functions return `ctmeas` and `cameas`, respectively.

Data Types: `function_handle` | `char`

SensorTransformParameters — Parameters for sensor transform function

structure | array of structures

Parameters for the sensor transform function, returned as a structure or an array of structures. If you only need to transform the state once, specify it as a structure. If you need to transform the state n times, specify it as an n -by-1 array of structures. For example, to transform a state from the scenario frame to the sensor frame, you usually need to first transform the state from the scenario rectangular frame to the platform rectangular frame, and then transform the state from the platform rectangular frame to the sensor spherical frame. The fields of the structure are:

Field	Description
Frame	Child coordinate frame type, specified as 'Rectangular' or 'Spherical'.
OriginPosition	Child frame origin position expressed in the Parent frame, specified as a 3-by-1 vector.
OriginVelocity	Child frame origin velocity expressed in the parent frame, specified as a 3-by-1 vector.
Orientation	Relative orientation between frames, specified as a 3-by-3 rotation matrix. If the <code>IsParentToChild</code> property is set to <code>false</code> , then specify <code>Orientation</code> as the rotation from the child frame to the parent frame. If the <code>IsParentToChild</code> property is set to <code>true</code> , then specify <code>Orientation</code> as the rotation from the parent frame to the child frame.
IsParentToChild	Flag to indicate the direction of rotation between parent and child frame, specified as <code>true</code> or <code>false</code> . The default is <code>false</code> . See description of the <code>Orientation</code> field for details.
HasAzimuth	Indicates whether outputs contain azimuth components, specified as <code>true</code> or <code>false</code> .

HasElevation	Indicates whether outputs contain elevation components, specified as <code>true</code> or <code>false</code> .
HasRange	Indicates whether outputs contain range components, specified as <code>true</code> or <code>false</code> .
HasVelocity	Indicates whether outputs contains velocity components, specified as <code>true</code> or <code>false</code> .

Note that here the scenario frame is the parent frame of the platform frame, and the platform frame is the parent frame of the sensor frame.

The default values for `SensorTransformParameters` are a 2-by-1 array of structures as:

Fields	Struct 1	Struct 2
Frame	'Spherical'	'Rectangular'
OriginPosition	[0;0;0]	[0;0;0]
OriginVelocity	[0;0;0]	[0;0;0]
Orientation	<code>eye(3)</code>	<code>eye(3)</code>
IsParentToChild	<code>false</code>	<code>false</code>
HasAzimuth	<code>true</code>	<code>true</code>
HasElevation	<code>true</code>	<code>true</code>
HasRange	<code>true</code>	<code>true</code>
HasVelocity	<code>false</code>	<code>true</code>

In this table, Struct 2 accounts for the transformation from the scenario rectangular frame to the platform rectangular frame, and Struct 1 accounts for the transformation from the platform rectangular frame to the sensor spherical frame, given the `isParentToChild` property is set to `false`.

Data Types: `struct`

SensorLimits – Sensor's detection limits

3-by-2 matrix (default) | N -by-2 matrix

Sensor's detection limits, specified as an N -by-2 matrix, where N is the output dimension of the sensor transform function. The matrix must describe the lower and upper detection limits of the sensor in the same order as the outputs of the sensor transform function.

If you use `cvmeas`, `cameas`, or `ctmeas` as the sensor transform function, then you need to provide the sensor limits in order as:

$$\text{SensorLimits} = \begin{bmatrix} \text{minAz} & \text{maxAz} \\ \text{minEl} & \text{maxEl} \\ \text{minRng} & \text{maxRng} \\ \text{minRr} & \text{maxRr} \end{bmatrix}$$

The description of these limits and their default values are given in the following table. Note that the default values for `SensorLimits` are a 3-by-2 matrix including the top six elements in the table. Moreover, if you use these three functions, you can specify the matrix to be in other sizes (1-by-2, 2-by-2, or 3-by-4), but you have to specify these limits in the sequence shown in the `SensorLimits` matrix.

Limits	Description	Default values
minAz	Minimum detectable azimuth in degrees.	-10
maxAz	Maximum detectable azimuth in degrees.	10
minEl	Minimum detectable elevation in degrees.	-2.5
maxEl	Maximum detectable elevation in degrees.	2.5
minRng	Minimum detectable range in meters.	0
maxRng	Maximum detectable range in meters.	1000
minRr	Minimum detectable range rate in meters per second.	N/A
maxRr	Maximum detectable range rate in meters per second.	N/A

Data Types: double

SensorResolution — Resolution of sensor

[4;2;10] (default) | *N*-element positive-valued vector

Resolution of a sensor, specified as a *N*-element positive-valued vector, where *N* is the number of parameters specified in the `SensorLimits` property. If you want to assign only one resolution cell for a parameter, simply specify its resolution as the difference between the maximum limit and the minimum limit of the parameter.

Data Types: double

MaxNumDetsPerObject — Maximum number of detections per object

Inf (default) | positive integer

Maximum number of detections the sensor can report per object, specified as a positive integer.

Example: 3

Data Types: double

ClutterDensity — Expected number of false alarms per unit volume

1e-3 (default) | positive scalar

Expected number of false alarms per unit volume from the sensor, specified as a positive scalar.

Example: 2e-3

Data Types: double

MinDetectionProbability — Probability of detecting track estimated to be outside of sensor limits

0.05 (default) | positive scalar

Probability of detecting a target estimated to be outside of the sensor limits, specified as a positive scalar. This property allows a `trackerPHD` object to consider that the estimated target, which is outside the sensor limits, may be detectable.

Example: 0.03

Data Types: double

Examples

Create Radar Sensor Configuration

Consider a radar with the following sensor limits and sensor resolution.

```
azLimits = [-10 10];
elLimits = [-2.5 2.5];
rangeLimits = [0 500];
rangeRateLimits = [-50 50];
sensorLimits = [azLimits;elLimits;rangeLimits;rangeRateLimits];
sensorResolution = [5 2 10 3];
```

Specifying the sensor transform function that transforms the Cartesian coordinates [x;y;vx;vy] in the scenario frame to the spherical coordinates [az;el;range;rr] in the sensor's frame. You can use the measurement function `cvmeas` as the sensor transform function.

```
transformFcn = @cvmeas;
```

To specify the parameters required for `cvmeas`, use the `SensorTransformParameters` property. Here, you assume the sensor is mounted at the center of the platform and the platform located at [100;30;20] is moving with a velocity of [-5;4;2] units per second in the scenario frame.

The first structure defines the sensor's location, velocity, and orientation in the platform frame.

```
params(1) = struct('Frame','Spherical','OriginPosition',[0;0;0],...
    'OriginVelocity',[0;0;0],'Orientation',eye(3),'HasRange',true,...
    'HasVelocity',true);
```

The second structure defines the platform's location, velocity, and orientation in the scenario frame.

```
params(2) = struct('Frame','Rectangular','OriginPosition',[100;30;20],...
    'OriginVelocity',[-5;4;2],'Orientation',eye(3),'HasRange',true,...
    'HasVelocity',true);
```

Create the configuration.

```
config = trackingSensorConfiguration('SensorIndex',3,'SensorLimits',sensorLimits,...
    'SensorResolution',sensorResolution,...
    'SensorTransformParameters',params,...
    'SensorTransformFcn',@cvmeas,...
    'FilterInitializationFcn',@initcvggiwphd)
```

```
config =
trackingSensorConfiguration with properties:
```

```
    SensorIndex: 3
    IsValidTime: 0

    SensorLimits: [4x2 double]
    SensorResolution: [4x1 double]
    SensorTransformFcn: @cvmeas
    SensorTransformParameters: [1x2 struct]

    FilterInitializationFcn: @initcvggiwphd
    MaxNumDetsPerObject: Inf

    ClutterDensity: 1.0000e-03
    DetectionProbability: 0.9000
    MinDetectionProbability: 0.0500
```

More About

Create a Tracking Sensor Configuration

To create the configuration for a sensor, you first need to specify the sensor transform function, which is usually given as:

$$Y = g(x, p)$$

where x denotes the tracking state, Y denotes detection states, and p denotes the required parameters. For object tracking applications, you mainly focus on obtaining an object's tracking state.

For example, a radar sensor can measure an object's azimuth, elevation, range, and possibly range-rate. Using a `trackingSensorConfiguration` object, you can specify a radar's transform function using the `SensorTransformFcn` property and specify the radar's mounting location, orientation, and velocity using corresponding fields in the `SensorTransformParameters` property. If the object is moving at a constant velocity, constant acceleration, or constant turning, you can use the built-in measurement function - `cvmeas`, `cameas`, or `ctmeas`, respectively - as the `SensorTransformFcn`. To set up the exact outputs of these three functions, specify the `hasAzimuth`, `hasElevation`, `hasRange`, and `hasVelocity` fields as `true` or `false` in the `SensorTransformParameters` property.

To set up the configuration of a sensor, you also need to specify the sensor's detection ability. Primarily, you need to specify the sensor's detection limits. For all the outputs of the sensor transform function, you need to provide the detection limits in the same order of these outputs using the `SensorLimits` property. For example, for a radar sensor, you might need to provide its azimuth, elevation, range, and range-rate limits. You can also specify the radar's `SensorResolution` and `MaxNumDetsPerObject` properties if you want to consider extended object detection. You might also want to specify other properties, such as `ClutterDensity`, `IsValidTime`, and `MinDetectionProbability` to further clarify the sensor's detection ability.

Extended Capabilities

C/C++ Code Generation

Generate C and C++ code using MATLAB® Coder™.

See Also

`cameas` | `ctmeas` | `cvmeas` | `ggiwphd` | `trackerPHD`

Introduced in R2019a

dynamicEvidentialGridMap

Dynamic grid map output from trackerGridRFS

Description

The `dynamicEvidentialGridMap` object represents the dynamic map estimate obtained from the grid-based tracker, `trackerGridRFS`. You can visualize the dynamic map and obtain the estimated values by using the object functions of `dynamicEvidentialGridMap`. The `dynamicEvidentialGridMap` object is a handle object.

Creation

You can generate a `dynamicEvidentialGridMap` object using a `trackerGridRFS` object. See the “Usage” on page 3-500 syntax of `trackerGridRFS` and the Obtain Estimated Values at Grid Level using `dynamicEvidentialGridMap` on page 2-44 example for details.

Properties

MotionModel — Motion model for tracking

'constant-velocity' | 'constant-acceleration' | 'constant-turn-rate'

This property is read-only.

Motion model for tracking, specified as 'constant-velocity', 'constant-acceleration', or 'constant-turn-rate'. The particle state and object state for each motion model are:

MotionModel	Particle State	Object State
'constant-velocity'	[x; vx; y; vy]	[x; vx; y; vy; yaw; L; W]
'constant-acceleration'	[x; vx; ax; y; vy; ay]	[x; vx; ax; y; vy; ay; yaw; L; W]
'constant-turn-rate'	[x; vx; y; vy; w]	[x; vx; y; vy; w; yaw; L; W]

where:

- x — Position of the object in the x direction of the tracking frame (m)
- y — Position of the object in the y direction of the tracking frame (m)
- vx — Velocity of the object in the x direction of the tracking frame (m/s)
- vy — Velocity of the object in the y direction of the tracking frame (m/s)
- ax — Acceleration of the object in the x direction of the tracking frame (m/s^2)
- ay — Acceleration of the object in the y direction of the tracking frame (m/s^2)
- w — Yaw-rate of the object in the tracking frame (degree/s)

- `yaw` — Yaw angle of the object in the tracking frame (deg)
- `L` — Length of the object (m)
- `W` — Width of the object (m)

NumStateVariables — Number of state variables

positive integer

This property is read-only.

Number of state variables corresponding to the motion model specified in the `MotionModel` property, specified as a positive integer.

Example: 6

GridLength — x-direction dimension of grid

100 (default) | positive scalar

This property is read-only.

x-direction dimension of the grid in the local coordinates, specified as a positive scalar in meters.

GridWidth — y-direction dimension of grid

100 (default) | positive scalar

This property is read-only.

y-direction dimension of the grid in the local coordinates, specified as a positive scalar in meters.

GridResolution — Resolution of grid

1 (default) | positive scalar

This property is read-only.

Resolution of the grid, specified as a positive scalar. `GridResolution` represents the number of cells per meter of the grid for both the x- and y-direction of the grid.

GridOriginInLocal — Location of grid origin in local coordinate frame

[-50 -50] (default) | two-element real-valued vector

This property is read-only.

Location of the grid origin in the local coordinate frame, specified as a two-element real-valued vector in meters. The grid origin represents the bottom-left corner of the grid map.

Object Functions

<code>getEvidences</code>	Get estimated occupancy and free evidences
<code>getOccupancy</code>	Get estimated occupancy probabilities
<code>getState</code>	Get full estimated state and associated uncertainty
<code>getVelocity</code>	Get estimated velocity and associated uncertainty
<code>show</code>	Visualize dynamic evidential grid map

Examples

Obtain Estimated Values at Grid Level using dynamicEvidentialGridMap

Create a tracking scenario.

```
rng(2021);% For reproducible results
scene = trackingScenario('UpdateRate',5,'StopTime',5);
```

Add a platform. Mount a lidar sensor on the platform.

```
plat = platform(scene);
lidar = monostaticLidarSensor(1,'DetectionCoordinates','Body');
```

Add two targets and define their position, velocity, orientation, dimension, and meshes.

```
for i = 1:2
    target = platform(scene);
    x = 50*(2*rand-1);
    y = 50*(2*rand-1);
    vx = 5*(2*rand-1);
    vy = 5*(2*rand-1);
    target.Trajectory.Position = [x y 0];
    target.Trajectory.Velocity = [vx vy 0];
    target.Trajectory.Orientation = quaternion([atan2d(vy,vx),0,0],'eulerd','ZYX','frame');
    target.Mesh = extendedObjectMesh('sphere');
    target.Dimensions = struct('Length',4, ...
        'Width',4, ...
        'Height',2, ...
        'OriginOffset',[0 0 0]);
end
```

Define the configuration of the sensor.

```
config = trackingSensorConfiguration(1, ...
    'SensorLimits',[-180 180;0 100], ...
    'SensorTransformParameters',struct, ...
    'IsValidTime',true);
```

Create a grid-based tracker.

```
tracker = trackerGridRFS('SensorConfigurations',config, ...
    'AssignmentThreshold',5, ...
    'MinNumCellsPerCluster',4, ...
    'ClusteringThreshold',3);
```

Advance scenario and run the tracker based on the lidar data.

```
while advance(scene)
    % Current time
    time = scene.SimulationTime;

    % Generate point cloud
    tgtMeshes = targetMeshes(plat);
    [ptCloud, config] = lidar(tgtMeshes, time);

    % Format the data for the tracker
    sensorData = struct('Time',time, ...
        'SensorIndex',1, ...
        'Measurement',ptCloud, ...
        'MeasurementParameters',struct ...
```

```

    );

    % Call tracker using sensorData to obtain the map in addition
    % to tracks
    [tracks, ~, ~, map] = tracker(sensorData,time);

    % Obtain the estimated occupancy probability of each cell
    P_occ = getOccupancy(map);

    % Obtain the estimated evidences for each cell
    [m_occ, m_free] = getEvidences(map);

    % Obtain the estimated velocity for each cell
    [v, Pv] = getVelocity(map);

    % Obtain the estimated state for each cell
    [x, P] = getState(map);

    % Show the map
    show(map, 'InvertColors',true)
end

```

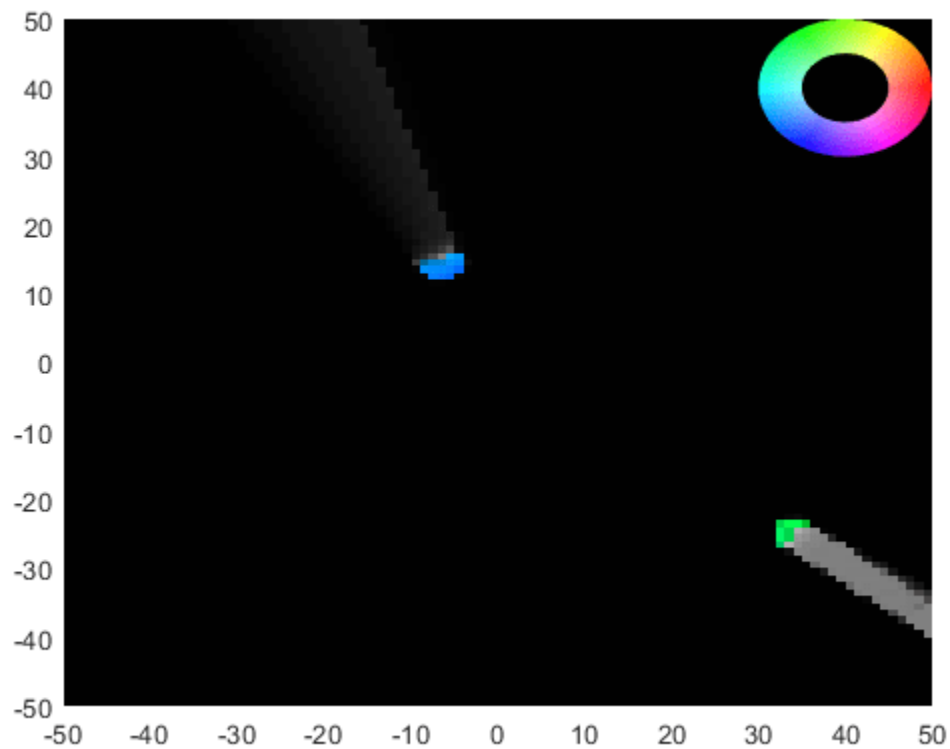

Extended Capabilities

C/C++ Code Generation

Generate C and C++ code using MATLAB® Coder™.

- The `dynamicEvidentialGridMap` object is a handle object, which cannot be used as an entry-point input or output in code generation.
- The `show` object function does not support code generation.

See Also

`predictMapToTime` | `trackerGridRFS`

Introduced in R2021a

getEvidences

Get estimated occupancy and free evidences

Syntax

```
[m0ccupy,mFree] = getEvidences(map)
[m0ccupy,mFree] = getEvidences(map,coordinates,'local')
[m0ccupy,mFree] = getEvidences(map,indices,'grid')
```

Description

[m0ccupy,mFree] = getEvidences(map) returns the occupied evidence m0ccupy and free evidence mFree for each grid cells on the dynamic evidential grid map.

[m0ccupy,mFree] = getEvidences(map,coordinates,'local') returns the occupied evidence m0ccupy and free evidence mFree for points specified by the local coordinates.

[m0ccupy,mFree] = getEvidences(map,indices,'grid') returns the occupied evidence m0ccupy and free evidence mFree for grid cells specified by the cell indices.

Examples

Get Evidences From Grid Map

Load an evidentialGridMap object from a data file.

```
load gridMapData.mat
map
map =
  dynamicEvidentialGridMap with properties:
    NumStateVariables: 4
    MotionModel: 'constant-velocity'
    GridLength: 100
    GridWidth: 100
    GridResolution: 1
    GridOriginInLocal: [-50 -50]
```

Get estimated occupancy and free evidences for the whole map, specific coordinates, and specific indices.

```
[m0ccupy,mFree] = getEvidences(map)
```

```
m0ccupy = 100x100
```

```
0 0 0 0 0 0 0 0 0
0 0 0 0 0 0 0 0 0
0 0 0 0 0 0 0 0 0
0 0 0 0 0 0 0 0 0
```

```

    0      0      0      0      0      0      0      0      0      0
    0      0      0      0      0      0      0      0      0      0
    0      0      0      0      0      0      0      0      0      0
    0      0      0      0      0      0      0      0      0      0
    0      0      0      0      0      0      0      0      0      0
    0      0      0      0      0      0      0      0      0      0
    :
mFree = 100x100
0.9952  0.9952  0.9952  0.9952  0.9952  0.9952  0.9952  0.9952  0.9952  0.9
0.9952  0.9952  0.9952  0.9952  0.9952  0.9952  0.9952  0.9952  0.9952  0.9
0.9952  0.9952  0.9952  0.9952  0.9952  0.9952  0.9952  0.9952  0.9952  0.9
0.9952  0.9952  0.9952  0.9952  0.9952  0.9952  0.9952  0.9952  0.9952  0.9
0.9952  0.9952  0.9952  0.9952  0.9952  0.9952  0.9952  0.9952  0.9952  0.9
0.9952  0.9952  0.9952  0.9952  0.9952  0.9952  0.9952  0.9952  0.9952  0.9
0.9952  0.9952  0.9952  0.9952  0.9952  0.9952  0.9952  0.9952  0.9952  0.9
0.9952  0.9952  0.9952  0.9952  0.9952  0.9952  0.9952  0.9952  0.9952  0.9
0.9952  0.9952  0.9952  0.9952  0.9952  0.9952  0.9952  0.9952  0.9952  0.9
0.9952  0.9952  0.9952  0.9952  0.9952  0.9952  0.9952  0.9952  0.9952  0.9
    :

```

```
[m0occupy,mFree] = getEvidences(map,[10 10;20 20], 'local')
```

```
m0occupy = 2x1
```

```
0
0
```

```
mFree = 2x1
```

```
0.9952
0.9952
```

```
[m0occupy,mFree] = getEvidences(map,[10 10; 72 8], 'grid')
```

```
m0occupy = 2x1
```

```
10-3 x
```

```
0.7801
0
```

```
mFree = 2x1
```

```
0.9952
0.9952
```

Input Arguments

map — Dynamic evidential grid map
dynamicEvidentialGridMap object

Dynamic evidential grid map, specified as a `dynamicEvidentialGridMap` object.

coordinates — Coordinates of local reference frame

N-by-2 real-valued matrix

Coordinates of local reference frame, specified as an *N*-by-2 real-valued matrix.

Example: [1 1;2.5 3]

indices — Grid cell indices

N-by-2 matrix of positive integers

Grid cell indices, specified as an *N*-by-2 matrix of positive integers.

Example: [1 1;2 3]

Output Arguments

mOccupancy — Occupied evidence

N-by-*M* matrix in range [0,1] | *N*-by-1 vector in range [0,1]

Occupied evidence of cells or points in the map, returned as an *N*-by-*M* matrix in range [0,1] or an *N*-by-1 vector in range [0,1].

- If the input is only the map, `mOccupancy` is returned as an *N*-by-*M* matrix, where *N* is the number of cells in the x-direction of the map and *M* is the number of cells in the y-direction of the map.
- If the input contains `coordinates`, `mOccupancy` is returned as an *N*-by-1 vector, where *N* is the number of coordinates specified by the `coordinates` argument.
- If the input contains `indices`, `mOccupancy` is returned as an *N*-by-1 vector, where *N* is the number of cells specified by the `indices` argument.

mFree — Free evidence

N-by-*M* matrix in range [0,1] | *N*-by-1 vector in range [0,1]

Free evidence of cells or points in the map, returned as an *N*-by-*M* matrix in range [0,1] or an *N*-by-1 vector in range [0,1].

- If the input is the map only, `mFree` is returned as an *N*-by-*M* matrix, where *N* is the number of cells in the x-direction of the map and *M* is the number of cells in the y-direction of the map.
- If the input contains `coordinates`, `mFree` is returned as an *N*-by-1 vector, where *N* is the number of coordinates specified by the `coordinates` argument.
- If the input contains `indices`, `mFree` is returned as an *N*-by-1 vector, where *N* is the number of cells specified by the `indices` argument.

See Also

`dynamicEvidentialGridMap` | `getOccupancy` | `getState` | `getVelocity` | `show`

Introduced in R2021a

getOccupancy

Get estimated occupancy probabilities

Syntax

```
p0occupancy = getOccupancy(map)
p0occupancy = getOccupancy(map,coordinates,'local')
p0occupancy = getOccupancy(map,indices,'grid')
```

Description

`p0occupancy = getOccupancy(map)` returns the occupancy probabilities of all grid cells in the map.

`p0occupancy = getOccupancy(map,coordinates,'local')` returns the occupancy probabilities for points specified by the local coordinates.

`p0occupancy = getOccupancy(map,indices,'grid')` returns the occupancy probabilities for grid cells specified by the cell indices.

Examples

Get Occupancy Probabilities From Grid Map

Load an `evidentialGridMap` object from a data file.

```
load gridMapData.mat
map
map =
  dynamicEvidentialGridMap with properties:
    NumStateVariables: 4
    MotionModel: 'constant-velocity'
    GridLength: 100
    GridWidth: 100
    GridResolution: 1
    GridOriginInLocal: [-50 -50]
```

Get estimated occupancy probabilities for the whole map, specific coordinates, and specific indices.

```
p0occupancy = getOccupancy(map)
```

```
p0occupancy = 100×100
```

```
0.0024    0.0024    0.0024    0.0024    0.0024    0.0024    0.0024    0.0024    0.0024    0.0024
0.0024    0.0024    0.0024    0.0024    0.0024    0.0024    0.0024    0.0024    0.0024    0.0024
0.0024    0.0024    0.0024    0.0024    0.0024    0.0024    0.0024    0.0024    0.0024    0.0024
0.0024    0.0024    0.0024    0.0024    0.0024    0.0024    0.0024    0.0024    0.0024    0.0024
0.0024    0.0024    0.0024    0.0024    0.0024    0.0024    0.0024    0.0024    0.0024    0.0024
```

```

0.0024  0.0024  0.0024  0.0024  0.0024  0.0024  0.0024  0.0024  0.0024  0.
0.0024  0.0024  0.0024  0.0024  0.0024  0.0024  0.0024  0.0024  0.0024  0.
0.0024  0.0024  0.0024  0.0024  0.0024  0.0024  0.0024  0.0024  0.0024  0.
0.0024  0.0024  0.0024  0.0024  0.0024  0.0024  0.0024  0.0024  0.0024  0.
0.0024  0.0024  0.0024  0.0024  0.0024  0.0024  0.0024  0.0024  0.0024  0.
  ⋮

```

```
p0occupancy = getOccupancy(map, [10 10; 20 20], 'local')
```

```
p0occupancy = 2×1
```

```

0.0024
0.0024

```

```
p0occupancy = getOccupancy(map, [10 10; 72 8], 'grid')
```

```
p0occupancy = 2×1
```

```

0.0028
0.0024

```

Input Arguments

map — Dynamic evidential grid map

dynamicEvidentialGridMap object

Dynamic evidential grid map, specified as a dynamicEvidentialGridMap object.

coordinates — Coordinates of local reference frame

N -by-2 real-valued matrix

Coordinates of local reference frame, specified as an N -by-2 real-valued matrix.

Example: [1 1; 2.5 3]

indices — Grid cell indices

N -by-2 matrix of positive integers

Grid cell indices, specified as an N -by-2 matrix of positive integers.

Example: [1 1; 2 3]

Output Arguments

p0occupancy — Occupancy probability

N -by- M matrix in range [0,1] | N -by-1 vector in range [0,1]

Occupancy probability of cells or points in the map, returned as an N -by- M matrix in range [0,1] or an N -by-1 vector in range [0,1].

- If the input is the map only, p0occupancy is returned as an N -by- M matrix, where N is the number of cells in the x-direction of the map and M is the number of cells in the y-direction of the map.

- If the input contains `coordinates`, `pOccupancy` is returned as an N -by-1 vector, where N is the number of coordinates specified in the `coordinates` argument.
- If the input contains `indices`, `pOccupancy` is returned as an N -by-1 vector, where N is the number of cells specified in the `indices` argument.

See Also

`dynamicEvidentialGridMap` | `getEvidences` | `getState` | `getVelocity` | `show`

Introduced in R2021a

getState

Get full estimated state and associated uncertainty

Syntax

```
state = getState(map)
state = getState(map,coordinates,'local')
state = getState(map,indices,'grid')
[state,stateVariance] = getState( ___ )
```

Description

`state = getState(map)` returns state estimates of all grid cells in the map.

`state = getState(map,coordinates,'local')` returns state estimates for points specified by the local coordinates.

`state = getState(map,indices,'grid')` returns state estimates for grid cells specified by the cell indices.

`[state,stateVariance] = getState(___)` additionally returns the variance of the state estimates.

Examples

Get State From Grid Map

Load an `evidentialGridMap` object from a data file.

```
load gridMapData.mat
map
map =
  dynamicEvidentialGridMap with properties:
    NumStateVariables: 4
    MotionModel: 'constant-velocity'
    GridLength: 100
    GridWidth: 100
    GridResolution: 1
    GridOriginInLocal: [-50 -50]
```

Get estimated state for the whole map, specific coordinates, and specific indices.

```
state = getState(map)

state =
state(:,:,1) =
    NaN    NaN    NaN    NaN    NaN    NaN    NaN    NaN    NaN
```



```
state = getState(map,[10 10;20 20], 'local');
squeeze(state(1,1,:))
```

```
ans = 4×1
```

```
NaN
NaN
NaN
NaN
```

```
state= getState(map,[10 10; 72 8], 'grid');
squeeze(state(1,1,:))
```

```
ans = 4×1
```

```
-40.5690
-0.4961
40.6397
9.8387
```

Input Arguments

map — Dynamic evidential grid map

dynamicEvidentialGridMap object

Dynamic evidential grid map, specified as a dynamicEvidentialGridMap object.

coordinates — Coordinates of local reference frame

N -by-2 real-valued matrix

Coordinates of local reference frame, specified as an N -by-2 real-valued matrix.

Example: [1 1;2.5 3]

indices — Grid cell indices

N -by-2 matrix of positive integers

Grid cell indices, specified as an N -by-2 matrix of positive integers.

Example: [1 1;2 3]

Output Arguments

state — State estimates of points or grid cells

N -by- M -by- D array | N -by-1-by- D array

State estimates of points or grid cells, returned as an N -by- M -by- D array or an N -by-1-by- D array .

- If the input is the map only, state is returned as an N -by- M -by- D array, where N is the number of cells in the x-direction of the map, M is the number of cells in the y-direction of the map, and D is the dimension of the state determined by the MotionModel property of the map.
- If the input contains coordinates, state is returned as an N -by-1-by- D array, where N is the number of coordinates specified in the coordinates argument and D is the dimension of the state determined by the MotionModel property of the map.

- If the input contains `indices`, `state` is returned as an N -by-1-by- D array, where N is the number of cells specified in the `indices` argument and D is the dimension of the state determined by the `MotionModel` property of the map.

stateVariance — Covariance of state estimates

N -by- M -by- D -by- D array | N -by-1-by- D -by- D array

Covariance of state estimates, returned as an N -by- M -by- D -by- D array or an N -by-1-by- D -by- D array.

- If the input is the `map` only, `stateVariance` is returned as an N -by- M -by- D -by- D array, where N is the number of cells in the x-direction of the map, M is the number of cells in the y-direction of the map, and D is the dimension of the state determined by the `MotionModel` property of the map.
- If the input contains `coordinates`, `variance` is returned as an N -by-1-by- D -by- D array, where N is the number of coordinates specified in the `coordinates` argument and D is the dimension of the state determined by the `MotionModel` property of the map.
- If the input contains `indices`, `stateVariance` is returned as an N -by-1-by- D -by- D array, where N is the number of cells specified in the `indices` argument and D is the dimension of the state determined by the `MotionModel` property of the map.

See Also

`dynamicEvidentialGridMap` | `getEvidences` | `getOccupancy` | `getVelocity` | `show`

Introduced in R2021a

getVelocity

Get estimated velocity and associated uncertainty

Syntax

```
velocity = getVelocity(map)
velocity = getVelocity(map,coordinates,'local')
velocity = getVelocity(map,indices,'grid')
[velocity,velocityVariance] = getVelocity( __ )
```

Description

`velocity = getVelocity(map)` returns velocity estimates of all grid cells in the map.

`velocity = getVelocity(map,coordinates,'local')` returns velocity estimates for points specified by the local coordinates.

`velocity = getVelocity(map,indices,'grid')` returns velocity estimates for grid cells specified by the cell indices.

`[velocity,velocityVariance] = getVelocity(__)` additionally returns the variance of the velocity estimates.

Examples

Get Velocity From Grid Map

Load an `evidentialGridMap` object from a data file.

```
load gridMapData.mat
map
map =
  dynamicEvidentialGridMap with properties:
    NumStateVariables: 4
    MotionModel: 'constant-velocity'
    GridLength: 100
    GridWidth: 100
    GridResolution: 1
    GridOriginInLocal: [-50 -50]
```

Get estimated velocity for the whole map, specific coordinates, and specific indices.

```
velocity = getVelocity(map)

velocity =
velocity(:,:,1) =
    NaN    NaN    NaN    NaN    NaN    NaN    NaN    NaN    NaN
```



```
velocity = getVelocity(map,[10 10;20 20], 'local');  
squeeze(velocity(1,1,:))
```

```
ans = 2×1
```

```
NaN  
NaN
```

```
velocity= getVelocity(map,[10 10; 72 8], 'grid');  
squeeze(velocity(1,1,:))
```

```
ans = 2×1
```

```
-0.4961  
9.8387
```

Input Arguments

map — Dynamic evidential grid map

dynamicEvidentialGridMap object

Dynamic evidential grid map, specified as a dynamicEvidentialGridMap object.

coordinates — Coordinates of local reference frame

N -by-2 real-valued matrix

Coordinates of local reference frame, specified as an N -by-2 real-valued matrix of.

Example: [1 1;2.5 3]

indices — Grid cell indices

N -by-2 matrix of positive integers

Grid cell indices, specified as an N -by-2 matrix of positive integers.

Example: [1 1;2 3]

Output Arguments

velocity — Velocity estimates of points or grid cells

N -by- M -by-2 array | N -by-1-by-2 array

Velocity estimates of points or grid cells, returned as an N -by- M -by-2 array or an N -by-1-by-2 array.

- If the input is the map only, `velocity` is returned as an N -by- M -by-2 array, where N is the number of cells in the x-direction of the map, and M is the number of cells in the y-direction of the map.
- If the input contains `coordinates`, `velocity` is returned as an N -by-1-by-2 array, where N is the number of coordinates specified in the `coordinates` argument.
- If the input contains `indices`, `velocity` is returned as an N -by-1-by-2 array, where N is the number of cells specified in the `indices` argument.

velocityVariance — Covariance of velocity estimates

N -by- M -by-2-by-2 array | N -by-1-by-2-by-2 array

Covariance of velocity estimates, returned as an N -by- M -by-2-by-2 array or an N -by-1-by-2-by-2 array.

- If the input is the map only, `velocityVariance` is returned as an N -by- M -by-2-by-2 array, where N is the number of cells in the x-direction of the map, and M is the number of cells in the y-direction of the map.
- If the input contains `coordinates`, `variance` is returned as an N -by-1-by-2-by-2 array, where N is the number of coordinates specified in the `coordinates` argument.
- If the input contains `indices`, `velocityVariance` is returned as an N -by-1-by- K -by- K array, where N is the number of cells specified in the `indices` argument.

See Also

`dynamicEvidentialGridMap` | `getEvidences` | `getOccupancy` | `getState` | `show`

Introduced in R2021a

show

Visualize dynamic evidential grid map

Syntax

```
show(map)
show(map, Name, Value)
```

Description

`show(map)` plots the dynamic occupancy grid map in local coordinates. The static cells are shown using grayscale images, in which the grayness represents the occupancy probability of the cell. The dynamic cells are shown using HSV (hue, saturation, and value) values on an RGB colormap:

- Hue — The orientation angle of the velocity vector divided by 360. As hue increases from 0 to 1, the color changes in the order of red to orange, yellow, green, cyan, blue, magenta, and back to red.
- Saturation — The Mahalanobis distance (d) between the velocity distribution of the grid cell and the zero velocity. A cell with $d > 4$ is drawn with full saturation.
- Value — The occupancy probability of the cell.

`show(map, Name, Value)` specifies options using one or more name-value pair arguments. Enclose each Name in quotes. For example, `show(myMap, 'PlotVelocity', true)` plots the dynamic map for `myMap` with velocity plotting enabled.

Examples

Show Evidential Grid Map

Load a `dynamicEvidentialGridMap` object from a data file.

```
load gridMapData.mat
map

map =
  dynamicEvidentialGridMap with properties:

    NumStateVariables: 4
    MotionModel: 'constant-velocity'
    GridLength: 100
    GridWidth: 100
    GridResolution: 1
    GridOriginInLocal: [-50 -50]
```

Show the grid map.

```
figure
show(map)
```

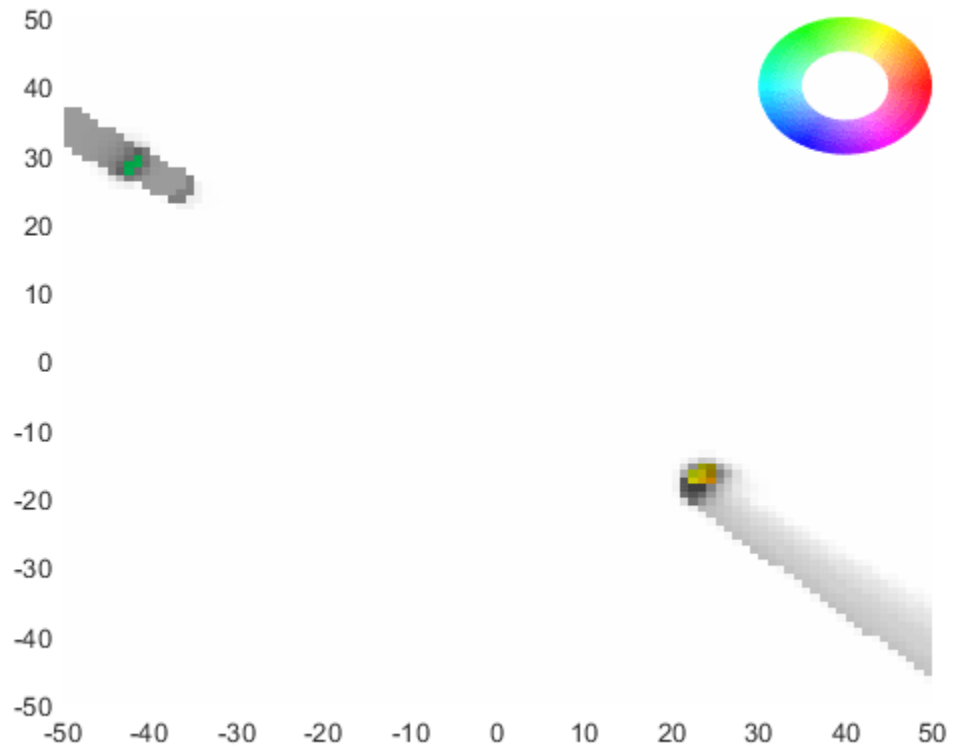
Show the grid map with velocity plotted and color inverted.

```
figure  
show(map, 'PlotVelocity', true, 'InvertColors', true)
```

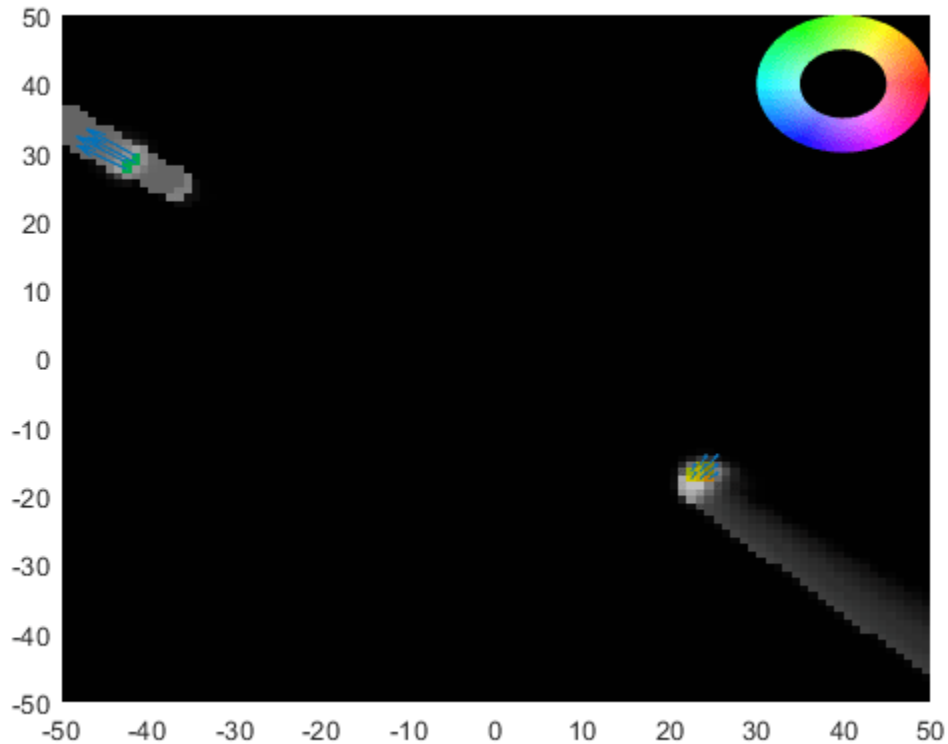

Input Arguments

map — Dynamic evidential grid map
dynamicEvidentialGridMap object

Dynamic evidential grid map, specified as a dynamicEvidentialGridMap object.

Name-Value Pair Arguments

Specify optional comma-separated pairs of `Name`, `Value` arguments. `Name` is the argument name and `Value` is the corresponding value. `Name` must appear inside quotes. You can specify several name and value pair arguments in any order as `Name1, Value1, ..., NameN, ValueN`.

Example: `showDynamicMap(myTracker, 'PlotVelocity', false)` plots the dynamic map for `myTracker` with velocity plotting enabled.

PlotVelocity — Enable velocity plotting
`false` (default) | `true`

Enable velocity plotting, specified as `true` or `false`. When specified as `true`, the velocity vector for each dynamic cell is plotted at the center of the grid cell. The length of the plotted vector represents the magnitude of the velocity.

Parent — Parent axes
`gca` (default) | axes handle

Parent axes on which to plot the map, specified as an axes handle.

FastUpdate — Enable updating from previous map`true (default) | false`

Enable updating from previous map, specified as `true` or `false`. When specified as `true`, the function plots the map via a lightweight update to the previous map in the figure. When specified as `false`, the function plots a new map on the figure every time.

InvertColors — Enable inverted colors`false (default) | true`

Enable inverted colors on the map, specified as `true` or `false`. When specified as `false`, the function plots empty space in white and occupied space in black. When specified as `true`, the function plots empty space in black and occupied space in white.

See Also`dynamicEvidentialGridMap | trackerGridRFS`**Introduced in R2021a**

pose

Current orientation and position estimate for `insfilterErrorState`

Syntax

```
[position,orientation,velocity] = pose(FUSE)
[position,orientation,velocity] = pose(FUSE,format)
```

Description

`[position,orientation,velocity] = pose(FUSE)` returns the current estimate of the pose of the object tracked by FUSE, an `insfilterErrorState` object.

`[position,orientation,velocity] = pose(FUSE,format)` returns the current estimate of the pose with orientation in the specified orientation format.

Input Arguments

FUSE — INS filter object

`insfilterErrorState`

`insfilterErrorState`, specified as an object.

format — Output orientation format

'quaternion' (default) | 'rotmat'

Output orientation format, specified as either 'quaternion' for a quaternion or 'rotmat' for a rotation matrix.

Data Types: char | string

Output Arguments

position — Position estimate in local NED coordinate system (m)

3-element row vector

Position estimate in the local NED coordinate system in meters, returned as a 3-element row vector.

Data Types: single | double

orientation — Orientation estimate in local NED coordinate system

quaternion (default) | 3-by-3 rotation matrix

Orientation estimate in the local NED coordinate system, returned as a scalar quaternion or 3-by-3 rotation matrix, depending on the specified orientation format. The quaternion or rotation matrix represents a frame rotation from the local NED reference frame to the body reference frame.

Data Types: single | double | quaternion

velocity — Velocity estimate in local NED coordinate system (m/s)

3-element row vector

Velocity estimate in the local NED coordinate system in m/s, returned as a 3-element row vector.

Data Types: `single` | `double`

Extended Capabilities

C/C++ Code Generation

Generate C and C++ code using MATLAB® Coder™.

See Also

`insfilter` | `insfilterErrorState`

Introduced in R2019a

copy

Create copy of `insfilterErrorState`

Syntax

```
newFilter = copy(filter)
```

Description

`newFilter = copy(filter)` returns a copy of the `insfilterErrorState`, `filter`, with the exactly same property values.

Input Arguments

filter — Filter to be copied

`insfilterErrorState`

Filter to be copied, specified as an `insfilterErrorState` object.

Output Arguments

newFilter — New copied filter

`insfilterErrorState`

New copied filter, returned as an `insfilterErrorState` object.

See Also

`insfilterErrorState`

Introduced in R2020b

stateinfo

Display state vector information for `insfilterErrorState`

Syntax

```
stateinfo(FUSE)
info = stateinfo(FUSE)
```

Description

`stateinfo(FUSE)` displays the meaning of each index of the `State` property of `FUSE`, an `insfilterErrorState` object, and the associated units.

`info = stateinfo(FUSE)` returns a structure with fields containing descriptions of the elements of the state vector of the filter, `FUSE`.

Examples

State Information of `insfilterErrorState`

Create an `insfilterErrorState` object.

```
filter = insfilterErrorState;
```

Display the state information of the created filter.

```
stateinfo(filter)
```

States	Units	Index
Orientation (quaternion parts)		1:4
Position (NAV)	m	5:7
Velocity (NAV)	m/s	8:10
Gyroscope Bias (XYZ)	rad/s	11:13
Accelerometer Bias (XYZ)	m/s ²	14:16
Visual Odometry Scale		17

Output the state information of the filter as a structure.

```
info = stateinfo(filter)
```

```
info = struct with fields:
    Orientation: [1 2 3 4]
    Position: [5 6 7]
    Velocity: [8 9 10]
    GyroscopeBias: [11 12 13]
    AccelerometerBias: [14 15 16]
    VisualOdometryScale: 17
```

Input Arguments

FUSE — INS filter object

`insfilterErrorState`

`insfilterErrorState`, specified as an object.

Output Arguments

info — State information

structure

State information, returned as a structure with fields containing descriptions of the elements of the state vector of the filter. The values of each field are the corresponding indices of the state vector.

Extended Capabilities

C/C++ Code Generation

Generate C and C++ code using MATLAB® Coder™.

See Also

`insfilter` | `insfilterErrorState`

Introduced in R2019a

reset

Reset internal states for `insfilterErrorState`

Syntax

```
reset(FUSE)
```

Description

`reset(FUSE)` resets the `State`, `StateCovariance`, and internal integrators of FUSE, an `insfilterErrorState` object, to their default values.

Input Arguments

FUSE — INS filter object

`insfilterErrorState`

`insfilterErrorState`, specified as an object.

Extended Capabilities

C/C++ Code Generation

Generate C and C++ code using MATLAB® Coder™.

See Also

`insfilter` | `insfilterErrorState`

Introduced in R2019a

predict

Update states using accelerometer and gyroscope data for `insfilterErrorState`

Syntax

```
predict(FUSE, accelReadings, gyroReadings)
```

Description

`predict(FUSE, accelReadings, gyroReadings)` fuses accelerometer and gyroscope data to update the state estimate.

Input Arguments

FUSE — INS filter object

`insfilterErrorState`

`insfilterErrorState`, specified as an object.

accelReadings — Accelerometer readings in local sensor body coordinate system (m/s²)

3-element row vector

Accelerometer readings in m/s², specified as a 3-element row vector.

Data Types: `single` | `double`

gyroReadings — Gyroscope readings in local sensor body coordinate system (rad/s)

3-element row vector

Gyroscope readings in rad/s, specified as a 3-element row vector.

Data Types: `single` | `double`

Extended Capabilities

C/C++ Code Generation

Generate C and C++ code using MATLAB® Coder™.

See Also

`insfilter` | `insfilterErrorState`

Introduced in R2019a

fusemvo

Correct states using monocular visual odometry for `insfilterErrorState`

Syntax

```
[pResidual,oResidual,resCov] = fusemvo(FUSE,position,positionCovariance,ornt,orntCovariance)
```

Description

`[pResidual,oResidual,resCov] = fusemvo(FUSE,position,positionCovariance,ornt,orntCovariance)` fuses position and orientation data from monocular visual odometry (MVO) measurements to correct the state and state estimation error covariance.

Input Arguments

FUSE — INS filter object

`insfilterErrorState`

`insfilterErrorState`, specified as an object.

position — Position of camera in local NED coordinate system (m)

3-element row vector

Position of camera in the local NED coordinate system in meters, specified as a real finite 3-element row vector.

Data Types: `single` | `double`

positionCovariance — Position measurement covariance of MVO (m²)

scalar | 3-element vector | 3-by-3 matrix

Position measurement covariance of MVO in m², specified as a scalar, 3-element vector, or 3-by-3 matrix.

Data Types: `single` | `double`

ornt — Orientation of camera with respect to local NED coordinate system

scalar quaternion | rotation matrix

Orientation of the camera with respect to the local NED coordinate system, specified as a scalar quaternion or 3-by-3 rotation matrix. The quaternion or rotation matrix is a frame rotation from the NED coordinate system to the current camera coordinate system.

Data Types: `quaternion` | `single` | `double`

orntCovariance — Orientation measurement covariance of monocular visual odometry (rad²)

scalar | 3-element vector | 3-by-3 matrix

Orientation measurement covariance of monocular visual odometry in rad², specified as a scalar, 3-element vector, or 3-by-3 matrix.

Data Types: `single` | `double`

Output Arguments

pResidual — Position residual

1-by-3 vector of real values

Position residual, returned as a 1-by-3 vector of real values in m.

oResidual — Rotation vector residual

1-by-3 vector of real values

Rotation vector residual, returned as a 1-by-3 vector of real values in radians.

resCov — Residual covariance

6-by-6 matrix of real values

Residual covariance, returned as a 6-by-6 matrix of real values.

Extended Capabilities

C/C++ Code Generation

Generate C and C++ code using MATLAB® Coder™.

See Also

`insfilter` | `insfilterErrorState`

Introduced in R2019a

residualmvo

Residuals and residual covariance from monocular visual odometry measurements for `insfilterErrorState`

Syntax

```
[pResidual,oResidual,resCov] = residualmvo(FUSE,position,positionCovariance,
ornt,orntCovariance)
```

Description

`[pResidual,oResidual,resCov] = residualmvo(FUSE,position,positionCovariance, ornt,orntCovariance)` computes the residual information based on the monocular visual odometry measurements and covariance.

Input Arguments

FUSE — INS filter object

`insfilterErrorState`

`insfilterErrorState`, specified as an object.

position — Position of camera in local NED coordinate system (m)

3-element row vector

Position of camera in the local NED coordinate system in meters, specified as a real finite 3-element row vector.

Data Types: `single` | `double`

positionCovariance — Position measurement covariance of MVO (m²)

scalar | 3-element vector | 3-by-3 matrix

Position measurement covariance of MVO in m², specified as a scalar, 3-element vector, or 3-by-3 matrix.

Data Types: `single` | `double`

ornt — Orientation of camera with respect to local NED coordinate system

scalar quaternion | rotation matrix

Orientation of the camera with respect to the local NED coordinate system, specified as a scalar quaternion or 3-by-3 rotation matrix. The quaternion or rotation matrix is a frame rotation from the NED coordinate system to the current camera coordinate system.

Data Types: `quaternion` | `single` | `double`

orntCovariance — Orientation measurement covariance of monocular visual odometry (rad²)

scalar | 3-element vector | 3-by-3 matrix

Orientation measurement covariance of monocular visual odometry in rad^2 , specified as a scalar, 3-element vector, or 3-by-3 matrix.

Data Types: `single` | `double`

Output Arguments

pResidual — Position residual

1-by-3 vector of real values

Position residual, returned as a 1-by-3 vector of real values in meters.

oResidual — Rotation vector residual

1-by-3 vector of real values

Rotation vector residual, returned as a 1-by-3 vector of real values in radians.

resCov — Residual covariance

6-by-6 matrix of real values

Residual covariance, returned as a 6-by-6 matrix of real values.

Extended Capabilities

C/C++ Code Generation

Generate C and C++ code using MATLAB® Coder™.

See Also

`insfilter` | `insfilterErrorState`

Introduced in R2020a

fusegps

Correct states using GPS data for `insfilterErrorState`

Syntax

```
[res,resCov] = fusegps(FUSE,position,positionCovariance)
[res,resCov] = fusegps(FUSE,position,positionCovariance,velocity,
velocityCovariance)
```

Description

`[res,resCov] = fusegps(FUSE,position,positionCovariance)` fuses GPS position data to correct the state estimate.

`[res,resCov] = fusegps(FUSE,position,positionCovariance,velocity,velocityCovariance)` fuses GPS position and velocity data to correct the state estimate.

Input Arguments

FUSE — INS filter object

`insfilterErrorState`

`insfilterErrorState`, specified as an object.

position — Position of GPS receiver (LLA)

3-element row vector

Position of GPS receiver in geodetic latitude, longitude, and altitude (LLA) specified as a real finite 3-element row vector. Latitude and longitude are in degrees with north and east being positive. Altitude is in meters.

Data Types: `single` | `double`

positionCovariance — Position measurement covariance of GPS receiver (m²)

scalar | 3-element row vector | 3-by-3 matrix

Position measurement covariance of GPS receiver in m², specified as a 3-by-3 matrix.

Data Types: `single` | `double`

velocity — Velocity of GPS receiver in local NED coordinate system (m/s)

3-element row vector

Velocity of the GPS receiver in the local NED coordinate system in m/s, specified as a 3-element row vector.

Data Types: `single` | `double`

velocityCovariance — Velocity measurement covariance of GPS receiver (m/s)²

scalar | 3-element row vector | 3-by-3 matrix

Velocity measurement covariance of the GPS receiver in the local NED coordinate system in (m/s)², specified as a 3-by-3 matrix.

Data Types: `single` | `double`

Output Arguments

res — Position and velocity residual

1-by-6 vector of real values

Position and velocity residual, returned as a 1-by-6 vector of real values in m and m/s, respectively.

resCov — Innovation residual

6-by-6 matrix of real values

Innovation residual, returned as a 6-by-6 matrix of real values.

Extended Capabilities

C/C++ Code Generation

Generate C and C++ code using MATLAB® Coder™.

See Also

`insfilter` | `insfilterErrorState`

Introduced in R2019a

correct

Correct states using direct state measurements for `insfilterErrorState`

Syntax

```
correct(FUSE, idx, measurement, measurementCovariance)
```

Description

`correct(FUSE, idx, measurement, measurementCovariance)` corrects the state and state estimation error covariance of FUSE, an `insfilterErrorState` object, based on the measurement and measurement covariance. The measurement maps directly to the state specified by the indices `idx`.

Input Arguments

FUSE — INS filter object

`insfilterErrorState`

`insfilterErrorState`, specified as an object.

idx — State vector index of measurements to correct

N -element vector of increasing integers in the range [1, 17]

State vector index of measurements to correct, specified as an N -element vector of increasing integers in the range [1, 17].

The state values represent:

State	Units	Index
Orientation (quaternion parts)	N/A	1:4
Position (NED)	m	5:7
Velocity (NED)	m/s	8:10
Gyroscope Bias (XYZ)	rad/s	11:13
Accelerometer Bias (XYZ)	m/s ²	14:16
Visual Odometry Scale (XYZ)	N/A	17

Data Types: `single` | `double`

measurement — Direct measurement of state

N -element vector

Direct measurement of state, specified as a N -element vector. N is the number of elements of the index argument, `idx`.

Data Types: `single` | `double`

measurementCovariance — Covariance of measurement

scalar | M -element vector | M -by- M matrix

Covariance of measurement, specified as a scalar, M -element vector, or M -by- M matrix. If you correct orientation (state indices 1-4), then $M = \text{numel}(\text{idx}) - 1$. If you do not correct orientation, then $M = \text{numel}(\text{idx})$.

Data Types: `single` | `double`

Extended Capabilities

C/C++ Code Generation

Generate C and C++ code using MATLAB® Coder™.

See Also

`insfilter` | `insfilterErrorState`

Introduced in R2019a

residual

Residuals and residual covariances from direct state measurements for `insfilterErrorState`

Syntax

```
[res, resCov]= residual(FUSE,idx,measurement,measurementCovariance)
```

Description

`[res, resCov]= residual(FUSE,idx,measurement,measurementCovariance)` computes the residual, `res`, and the residual covariance, `resCov`, based on the direct state measurement and measurement covariance. The `measurement` maps directly to the states specified by indices, `idx`.

Input Arguments

FUSE — INS filter object

`insfilterErrorState`

`insfilterErrorState`, specified as an object.

idx — State vector index of measurements to correct

N-element vector of increasing integers in the range [1, 17]

State vector index of measurements to correct, specified as an *N*-element vector of increasing integers in the range [1, 17].

The state values represent:

State	Units	Index
Orientation (quaternion parts)	N/A	1:4
Position (NED)	m	5:7
Velocity (NED)	m/s	8:10
Gyroscope Bias (XYZ)	rad/s	11:13
Accelerometer Bias (XYZ)	m/s ²	14:16
Visual Odometry Scale (XYZ)	N/A	17

Data Types: `single` | `double`

measurement — Direct measurement of state

N-element vector

Direct measurement of state, specified as a *N*-element vector. *N* is the number of elements of the index argument, `idx`.

measurementCovariance — Covariance of measurement

N-by-*N* matrix

Covariance of measurement, specified as an N -by- N matrix. N is the number of elements of the index argument, `idx`.

Output Arguments

res — Measurement residual

1-by- N vector of real values

Measurement residual, returned as a 1-by- N vector of real values.

resCov — Residual covariance

N -by- N matrix of real values

Residual covariance, returned as a N -by- N matrix of real values.

Extended Capabilities

C/C++ Code Generation

Generate C and C++ code using MATLAB® Coder™.

See Also

`insfilterErrorState`

Introduced in R2020a

residualgps

Residuals and residual covariance from GPS measurements for `insfilterErrorState`

Syntax

```
[res,resCov] = residualgps(FUSE,position,positionCovariance)
[res,resCov] = residualgps(FUSE,position,positionCovariance,velocity,
velocityCovariance)
```

Description

`[res,resCov] = residualgps(FUSE,position,positionCovariance)` computes the residual, `res`, and the residual covariance, `resCov`, based on the GPS position measurement and covariance.

`[res,resCov] = residualgps(FUSE,position,positionCovariance,velocity,velocityCovariance)` computes the residual, `res`, and the residual covariance, `resCov`, based on the GPS position measurement and covariance.

Input Arguments

FUSE — INS filter object

`insfilterErrorState`

`insfilterErrorState`, specified as an object.

position — Position of GPS receiver (LLA)

3-element row vector

Position of GPS receiver in geodetic latitude, longitude, and altitude (LLA) specified as a real finite 3-element row vector. Latitude and longitude are in degrees with north and east being positive. Altitude is in meters.

Data Types: `single` | `double`

positionCovariance — Position measurement covariance of GPS receiver (m²)

3-by-3 matrix

Position measurement covariance of GPS receiver in m², specified as a 3-by-3 matrix.

Data Types: `single` | `double`

velocity — Velocity of GPS receiver in local NED coordinate system (m/s)

3-element row vector

Velocity of the GPS receiver in the local NED coordinate system in m/s, specified as a 3-element row vector.

Data Types: `single` | `double`

velocityCovariance — Velocity measurement covariance of GPS receiver (m/s²)

3-by-3 matrix

Velocity measurement covariance of the GPS receiver in the local NED coordinate system in m/s^2 , specified as a 3-by-3 matrix.

Data Types: `single` | `double`

Output Arguments

res — Position and velocity residual

1-by-3 vector of real values | 1-by-6 vector of real values

Position and velocity residual, returned as a 1-by-3 vector of real values if the inputs only contain position information, and returned as 1-by-6 vector of real values if the inputs also contain velocity information.

resCov — Residual covariance

3-by-3 matrix of real values | 6-by-6 matrix of real values

Residual covariance, returned as a 3-by-3 matrix of real values if the inputs only contain position information, and a 6-by-6 matrix of real values if the inputs also contain velocity information.

Extended Capabilities

C/C++ Code Generation

Generate C and C++ code using MATLAB® Coder™.

See Also

`insfilterErrorState`

Introduced in R2020a

tune

Tune `insfilterErrorState` parameters to reduce estimation error

Syntax

```
tunedMeasureNoise = tune(filter,measureNoise,sensorData,groundTruth)
tunedMeasureNoise = tune(___,config)
```

Description

`tunedMeasureNoise = tune(filter,measureNoise,sensorData,groundTruth)` adjusts the properties of the `insfilterErrorState` filter object, `filter`, and measurement noises to reduce the root-mean-squared (RMS) state estimation error between the fused sensor data and the ground truth. The function also returns the tuned measurement noise, `tunedMeasureNoise`. The function uses the property values in the filter and the measurement noise provided in the `measureNoise` structure as the initial estimate for the optimization algorithm.

`tunedMeasureNoise = tune(___,config)` specifies the tuning configuration based on a `tunerconfig` object, `config`.

Examples

Tune `insfilterErrorState` to Optimize Pose Estimate

Load the recorded sensor data and ground truth data.

```
load('insfilterErrorStateTuneData.mat');
```

Create tables for the sensor data and the truth data.

```
sensorData = table(Accelerometer,Gyroscope, ...
    GPSPosition,GPSVelocity,MV0Orientation, ...
    MV0Position);
groundTruth = table(Orientation,Position);
```

Create an `insfilterErrorState` filter object.

```
filter = insfilterErrorState('State',initialState, ...
    'StateCovariance',initialStateCovariance);
```

Create a tuner configuration object for the filter. Use the tuner noise function to obtain a set of initial sensor noises used in the filter.

```
cfg = tunerconfig('insfilterErrorState','MaxIterations',40);
measNoise = tunernoise('insfilterErrorState')
```

```
measNoise = struct with fields:
    MV0orientationNoise: 1
    MV0PositionNoise: 1
    GPSPositionNoise: 1
```

```
GPSVelocityNoise: 1
```

Tune the filter and obtain the tuned parameters.

```
tunedmn = tune(filter, measNoise, sensorData, ...
              groundTruth, cfg);
```

Iteration	Parameter	Metric
1	AccelerometerNoise	4.1291
1	GyroscopeNoise	4.1291
1	AccelerometerBiasNoise	4.1290
1	GyroscopeBiasNoise	4.1290
1	GPSPositionNoise	4.0213
1	GPSVelocityNoise	4.0051
1	MVOPositionNoise	3.9949
1	MVORientationNoise	3.9886
2	AccelerometerNoise	3.9886
2	GyroscopeNoise	3.9886
2	AccelerometerBiasNoise	3.9886
2	GyroscopeBiasNoise	3.9886
2	GPSPositionNoise	3.8381
2	GPSVelocityNoise	3.8268
2	MVOPositionNoise	3.8219
2	MVORientationNoise	3.8035
3	AccelerometerNoise	3.8035
3	GyroscopeNoise	3.8035
3	AccelerometerBiasNoise	3.8035
3	GyroscopeBiasNoise	3.8035
3	GPSPositionNoise	3.6299
3	GPSVelocityNoise	3.6276
3	MVOPositionNoise	3.6241
3	MVORientationNoise	3.5911
4	AccelerometerNoise	3.5911
4	GyroscopeNoise	3.5911
4	AccelerometerBiasNoise	3.5911
4	GyroscopeBiasNoise	3.5911
4	GPSPositionNoise	3.1728
4	GPSVelocityNoise	3.1401
4	MVOPositionNoise	2.7686
4	MVORientationNoise	2.6632
5	AccelerometerNoise	2.6632
5	GyroscopeNoise	2.6632
5	AccelerometerBiasNoise	2.6632
5	GyroscopeBiasNoise	2.6632
5	GPSPositionNoise	2.3242
5	GPSVelocityNoise	2.2291
5	MVOPositionNoise	2.2291
5	MVORientationNoise	2.0904
6	AccelerometerNoise	2.0903
6	GyroscopeNoise	2.0903
6	AccelerometerBiasNoise	2.0903
6	GyroscopeBiasNoise	2.0903
6	GPSPositionNoise	2.0903
6	GPSVelocityNoise	2.0141
6	MVOPositionNoise	1.9952
6	MVORientationNoise	1.8497

7	AccelerometerNoise	1.8497
7	GyroscopeNoise	1.8496
7	AccelerometerBiasNoise	1.8496
7	GyroscopeBiasNoise	1.8496
7	GPSPositionNoise	1.8398
7	GPSVelocityNoise	1.7528
7	MVOPositionNoise	1.7362
7	MVORIENTATIONNoise	1.5762
8	AccelerometerNoise	1.5762
8	GyroscopeNoise	1.5762
8	AccelerometerBiasNoise	1.5762
8	GyroscopeBiasNoise	1.5762
8	GPSPositionNoise	1.5762
8	GPSVelocityNoise	1.5107
8	MVOPositionNoise	1.4786
8	MVORIENTATIONNoise	1.3308
9	AccelerometerNoise	1.3308
9	GyroscopeNoise	1.3308
9	AccelerometerBiasNoise	1.3308
9	GyroscopeBiasNoise	1.3308
9	GPSPositionNoise	1.3308
9	GPSVelocityNoise	1.2934
9	MVOPositionNoise	1.2525
9	MVORIENTATIONNoise	1.1462
10	AccelerometerNoise	1.1462
10	GyroscopeNoise	1.1462
10	AccelerometerBiasNoise	1.1462
10	GyroscopeBiasNoise	1.1462
10	GPSPositionNoise	1.1443
10	GPSVelocityNoise	1.1332
10	MVOPositionNoise	1.0964
10	MVORIENTATIONNoise	1.0382
11	AccelerometerNoise	1.0382
11	GyroscopeNoise	1.0382
11	AccelerometerBiasNoise	1.0382
11	GyroscopeBiasNoise	1.0382
11	GPSPositionNoise	1.0348
11	GPSVelocityNoise	1.0348
11	MVOPositionNoise	1.0081
11	MVORIENTATIONNoise	0.9734
12	AccelerometerNoise	0.9734
12	GyroscopeNoise	0.9734
12	AccelerometerBiasNoise	0.9734
12	GyroscopeBiasNoise	0.9734
12	GPSPositionNoise	0.9693
12	GPSVelocityNoise	0.9682
12	MVOPositionNoise	0.9488
12	MVORIENTATIONNoise	0.9244
13	AccelerometerNoise	0.9244
13	GyroscopeNoise	0.9244
13	AccelerometerBiasNoise	0.9244
13	GyroscopeBiasNoise	0.9244
13	GPSPositionNoise	0.9203
13	GPSVelocityNoise	0.9199
13	MVOPositionNoise	0.9045
13	MVORIENTATIONNoise	0.8846
14	AccelerometerNoise	0.8846
14	GyroscopeNoise	0.8846

14	AccelerometerBiasNoise	0.8845
14	GyroscopeBiasNoise	0.8845
14	GPSPositionNoise	0.8807
14	GPSVelocityNoise	0.8807
14	MVOPositionNoise	0.8659
14	MVORIENTATIONNoise	0.8501
15	AccelerometerNoise	0.8501
15	GyroscopeNoise	0.8501
15	AccelerometerBiasNoise	0.8500
15	GyroscopeBiasNoise	0.8500
15	GPSPositionNoise	0.8457
15	GPSVelocityNoise	0.8453
15	MVOPositionNoise	0.8299
15	MVORIENTATIONNoise	0.8173
16	AccelerometerNoise	0.8173
16	GyroscopeNoise	0.8173
16	AccelerometerBiasNoise	0.8172
16	GyroscopeBiasNoise	0.8172
16	GPSPositionNoise	0.8122
16	GPSVelocityNoise	0.8116
16	MVOPositionNoise	0.7961
16	MVORIENTATIONNoise	0.7858
17	AccelerometerNoise	0.7858
17	GyroscopeNoise	0.7858
17	AccelerometerBiasNoise	0.7857
17	GyroscopeBiasNoise	0.7857
17	GPSPositionNoise	0.7807
17	GPSVelocityNoise	0.7800
17	MVOPositionNoise	0.7655
17	MVORIENTATIONNoise	0.7572
18	AccelerometerNoise	0.7572
18	GyroscopeNoise	0.7572
18	AccelerometerBiasNoise	0.7570
18	GyroscopeBiasNoise	0.7570
18	GPSPositionNoise	0.7525
18	GPSVelocityNoise	0.7520
18	MVOPositionNoise	0.7401
18	MVORIENTATIONNoise	0.7338
19	AccelerometerNoise	0.7337
19	GyroscopeNoise	0.7337
19	AccelerometerBiasNoise	0.7335
19	GyroscopeBiasNoise	0.7335
19	GPSPositionNoise	0.7293
19	GPSVelocityNoise	0.7290
19	MVOPositionNoise	0.7185
19	MVORIENTATIONNoise	0.7140
20	AccelerometerNoise	0.7138
20	GyroscopeNoise	0.7138
20	AccelerometerBiasNoise	0.7134
20	GyroscopeBiasNoise	0.7134
20	GPSPositionNoise	0.7086
20	GPSVelocityNoise	0.7068
20	MVOPositionNoise	0.6956
20	MVORIENTATIONNoise	0.6926
21	AccelerometerNoise	0.6922
21	GyroscopeNoise	0.6922
21	AccelerometerBiasNoise	0.6916
21	GyroscopeBiasNoise	0.6916

21	GPSPositionNoise	0.6862
21	GPSVelocityNoise	0.6822
21	MVOPositionNoise	0.6682
21	MVORIENTATIONNoise	0.6667
22	AccelerometerNoise	0.6660
22	GyroscopeNoise	0.6660
22	AccelerometerBiasNoise	0.6650
22	GyroscopeBiasNoise	0.6650
22	GPSPositionNoise	0.6605
22	GPSVelocityNoise	0.6541
22	MVOPositionNoise	0.6372
22	MVORIENTATIONNoise	0.6368
23	AccelerometerNoise	0.6356
23	GyroscopeNoise	0.6356
23	AccelerometerBiasNoise	0.6344
23	GyroscopeBiasNoise	0.6344
23	GPSPositionNoise	0.6324
23	GPSVelocityNoise	0.6252
23	MVOPositionNoise	0.6087
23	MVORIENTATIONNoise	0.6087
24	AccelerometerNoise	0.6075
24	GyroscopeNoise	0.6075
24	AccelerometerBiasNoise	0.6068
24	GyroscopeBiasNoise	0.6068
24	GPSPositionNoise	0.6061
24	GPSVelocityNoise	0.6032
24	MVOPositionNoise	0.6032
24	MVORIENTATIONNoise	0.6032
25	AccelerometerNoise	0.6017
25	GyroscopeNoise	0.6017
25	AccelerometerBiasNoise	0.6012
25	GyroscopeBiasNoise	0.6012
25	GPSPositionNoise	0.6010
25	GPSVelocityNoise	0.6005
25	MVOPositionNoise	0.6005
25	MVORIENTATIONNoise	0.6005
26	AccelerometerNoise	0.5992
26	GyroscopeNoise	0.5992
26	AccelerometerBiasNoise	0.5987
26	GyroscopeBiasNoise	0.5987
26	GPSPositionNoise	0.5983
26	GPSVelocityNoise	0.5983
26	MVOPositionNoise	0.5983
26	MVORIENTATIONNoise	0.5980
27	AccelerometerNoise	0.5973
27	GyroscopeNoise	0.5973
27	AccelerometerBiasNoise	0.5972
27	GyroscopeBiasNoise	0.5972
27	GPSPositionNoise	0.5970
27	GPSVelocityNoise	0.5970
27	MVOPositionNoise	0.5970
27	MVORIENTATIONNoise	0.5970
28	AccelerometerNoise	0.5970
28	GyroscopeNoise	0.5970
28	AccelerometerBiasNoise	0.5970
28	GyroscopeBiasNoise	0.5970
28	GPSPositionNoise	0.5970
28	GPSVelocityNoise	0.5970

28	MVOPositionNoise	0.5969
28	MVORientationNoise	0.5966
29	AccelerometerNoise	0.5966
29	GyroscopeNoise	0.5966
29	AccelerometerBiasNoise	0.5966
29	GyroscopeBiasNoise	0.5966
29	GPSPositionNoise	0.5966
29	GPSVelocityNoise	0.5966
29	MVOPositionNoise	0.5965
29	MVORientationNoise	0.5965
30	AccelerometerNoise	0.5965
30	GyroscopeNoise	0.5965
30	AccelerometerBiasNoise	0.5965
30	GyroscopeBiasNoise	0.5965
30	GPSPositionNoise	0.5964
30	GPSVelocityNoise	0.5964
30	MVOPositionNoise	0.5964
30	MVORientationNoise	0.5961
31	AccelerometerNoise	0.5961
31	GyroscopeNoise	0.5961
31	AccelerometerBiasNoise	0.5960
31	GyroscopeBiasNoise	0.5960
31	GPSPositionNoise	0.5960
31	GPSVelocityNoise	0.5960
31	MVOPositionNoise	0.5960
31	MVORientationNoise	0.5958
32	AccelerometerNoise	0.5956
32	GyroscopeNoise	0.5956
32	AccelerometerBiasNoise	0.5956
32	GyroscopeBiasNoise	0.5956
32	GPSPositionNoise	0.5955
32	GPSVelocityNoise	0.5955
32	MVOPositionNoise	0.5954
32	MVORientationNoise	0.5954
33	AccelerometerNoise	0.5954
33	GyroscopeNoise	0.5954
33	AccelerometerBiasNoise	0.5953
33	GyroscopeBiasNoise	0.5953
33	GPSPositionNoise	0.5953
33	GPSVelocityNoise	0.5953
33	MVOPositionNoise	0.5952
33	MVORientationNoise	0.5950
34	AccelerometerNoise	0.5949
34	GyroscopeNoise	0.5949
34	AccelerometerBiasNoise	0.5949
34	GyroscopeBiasNoise	0.5949
34	GPSPositionNoise	0.5948
34	GPSVelocityNoise	0.5947
34	MVOPositionNoise	0.5946
34	MVORientationNoise	0.5946
35	AccelerometerNoise	0.5946
35	GyroscopeNoise	0.5946
35	AccelerometerBiasNoise	0.5946
35	GyroscopeBiasNoise	0.5946
35	GPSPositionNoise	0.5946
35	GPSVelocityNoise	0.5945
35	MVOPositionNoise	0.5944
35	MVORientationNoise	0.5943

36	AccelerometerNoise	0.5942
36	GyroscopeNoise	0.5942
36	AccelerometerBiasNoise	0.5942
36	GyroscopeBiasNoise	0.5942
36	GPSPositionNoise	0.5941
36	GPSVelocityNoise	0.5941
36	MVOPositionNoise	0.5939
36	MVORIENTATIONNoise	0.5939
37	AccelerometerNoise	0.5939
37	GyroscopeNoise	0.5939
37	AccelerometerBiasNoise	0.5939
37	GyroscopeBiasNoise	0.5939
37	GPSPositionNoise	0.5939
37	GPSVelocityNoise	0.5939
37	MVOPositionNoise	0.5937
37	MVORIENTATIONNoise	0.5937
38	AccelerometerNoise	0.5937
38	GyroscopeNoise	0.5937
38	AccelerometerBiasNoise	0.5937
38	GyroscopeBiasNoise	0.5937
38	GPSPositionNoise	0.5936
38	GPSVelocityNoise	0.5935
38	MVOPositionNoise	0.5935
38	MVORIENTATIONNoise	0.5935
39	AccelerometerNoise	0.5935
39	GyroscopeNoise	0.5935
39	AccelerometerBiasNoise	0.5935
39	GyroscopeBiasNoise	0.5935
39	GPSPositionNoise	0.5934
39	GPSVelocityNoise	0.5934
39	MVOPositionNoise	0.5934
39	MVORIENTATIONNoise	0.5934
40	AccelerometerNoise	0.5934
40	GyroscopeNoise	0.5934
40	AccelerometerBiasNoise	0.5934
40	GyroscopeBiasNoise	0.5934
40	GPSPositionNoise	0.5933
40	GPSVelocityNoise	0.5933
40	MVOPositionNoise	0.5933
40	MVORIENTATIONNoise	0.5933

Fuse the sensor data using the tuned filter.

```

N = size(sensorData,1);
qEstTuned = quaternion.zeros(N,1);
posEstTuned = zeros(N,3);
for ii=1:N
    predict(filter, Accelerometer(ii,:),Gyroscope(ii,:));
    if all(~isnan(GPSPosition(ii,1)))
        fusegps(filter,GPSPosition(ii,:), ...
            tunedmn.GPSPositionNoise,GPSVelocity(ii,:), ...
            tunedmn.GPSVelocityNoise);
    end
    if all(~isnan(MVOPosition(ii,1)))
        fusemvo(filter,MVOPosition(ii,:),tunedmn.MVOPositionNoise, ...
            MVORIENTATION{ii},tunedmn.MVORIENTATIONNoise);
    end
end

```

```
    [posEstTuned(ii,:),qEstTuned(ii,:)] = pose(filter);  
end
```

Compute the RMS errors.

```
orientationErrorTuned = rad2deg(dist(qEstTuned,Orientation));  
rmsOrientationErrorTuned = sqrt(mean(orientationErrorTuned.^2))
```

```
rmsOrientationErrorTuned = 4.2335
```

```
positionErrorTuned = sqrt(sum((posEstTuned - Position).^2,2));  
rmsPositionErrorTuned = sqrt(mean( positionErrorTuned.^2))
```

```
rmsPositionErrorTuned = 0.1024
```

Visualize the results.

```
figure;  
t = (0:N-1)./filter.IMUSampleRate;  
subplot(2,1,1)  
plot(t, positionErrorTuned,'b');  
title("Tuned insfilterErrorState" + newline + ...  
      "Euclidean Distance Position Error")  
xlabel('Time (s)');  
ylabel('Position Error (meters)')  
subplot(2,1,2)  
plot(t, orientationErrorTuned,'b');  
title("Orientation Error")  
xlabel('Time (s)');  
ylabel('Orientation Error (degrees)');
```

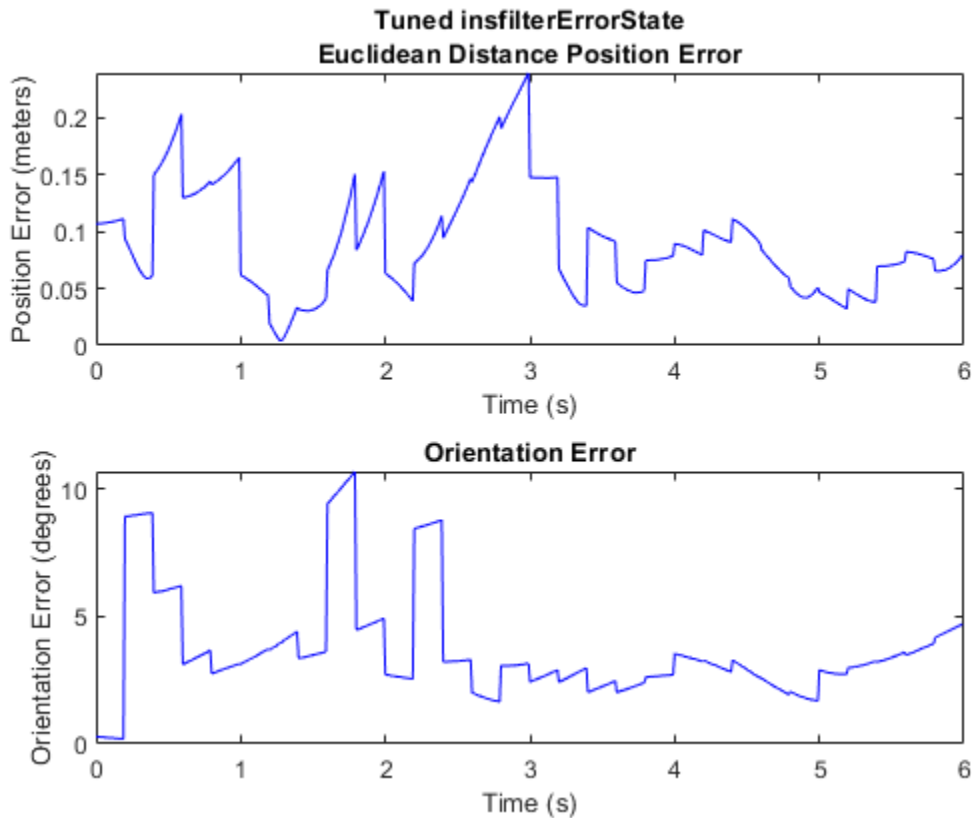

Input Arguments

filter – Filter object

`insfilterErrorState` object

Filter object, specified as an `insfilterErrorState` object.

measureNoise – Measurement noise

structure

Measurement noise, specified as a structure. The function uses the measurement noise input as the initial guess for tuning the measurement noise. The structure must contain these fields:

Field name	Description
MVORIENTATIONNoise	Orientation measurement covariance of monocular visual odometry, specified as a scalar, 3-element vector, or 3-by-3 matrix in rad^2
MVOPositionNoise	Position measurement covariance of MVO, specified as a scalar, 3-element vector, or 3-by-3 matrix in m^2
GPSPositionNoise	Variance of GPS position noise, specified as a scalar in m^2

Field name	Description
GPSVelocityNoise	Variance of GPS velocity noise, specified as a scalar in (m/s) ²

sensorData — Sensor data

table

Sensor data, specified as a table. In each row, the sensor data is specified as:

- **Accelerometer** — Accelerometer data, specified as a 1-by-3 vector of scalars in m²/s.
- **Gyroscope**— Gyroscope data, specified as a 1-by-3 vector of scalars in rad/s.
- **MVORIENTATION** — Orientation of the camera with respect to the local navigation frame, specified as a scalar quaternion or 3-by-3 rotation matrix. The quaternion or rotation matrix is a frame rotation from the local navigation frame to the current camera coordinate system.
- **MVOPosition** — Position of camera in the local navigation frame, specified as a real 3-element row vector in meters.
- **GPSPosition** — GPS position data, specified as a 1-by-3 vector of scalars in meters.
- **GPSVelocity** — GPS velocity data, specified as a 1-by-3 vector of scalars in m/s.

If the GPS sensor does not produce complete measurements, specify the corresponding entry for **GPSPosition** and/or **GPSVelocity** as **NaN**. If you set the **Cost** property of the tuner configuration input, **config**, to **Custom**, then you can use other data types for the **sensorData** input based on your choice.

groundTruth — Ground truth data

table

Ground truth data, specified as a table. In each row, the table can optionally contain any of these variables:

- **Orientation** — Orientation from the navigation frame to the body frame, specified as a quaternion or a 3-by-3 rotation matrix.
- **Position** — Position in navigation frame, specified as a 1-by-3 vector of scalars in meters.
- **Velocity** — Velocity in navigation frame, specified as a 1-by-3 vector of scalars in m/s.
- **AccelerometerBias** — Accelerometer delta angle bias in body frame, specified as a 1-by-3 vector of scalars in m²/s.
- **VisualOdometryScale** — Visual odometry scale factor, specified as a scalar.

The function processes each row of the **sensorData** and **groundTruth** tables sequentially to calculate the state estimate and RMS error from the ground truth. State variables not present in **groundTruth** input are ignored for the comparison. The **sensorData** and the **groundTruth** tables must have the same number of rows.

If you set the **Cost** property of the tuner configuration input, **config**, to **Custom**, then you can use other data types for the **groundTruth** input based on your choice.

config — Tuner configuration

tunerconfig object

Tuner configuration, specified as a **tunerconfig** object.

Output Arguments

tunedMeasureNoise — Tuned measurement noise

structure

Tuned measurement noise, returned as a structure. The structure contains these fields.

Field name	Description
MVORIENTATIONNoise	Orientation measurement covariance of monocular visual odometry, specified as a scalar, 3-element vector, or 3-by-3 matrix in rad ²
MVOPositionNoise	Position measurement covariance of MVO, specified as a scalar, 3-element vector, or 3-by-3 matrix in m ²
GPSPositionNoise	Variance of GPS position noise, specified as a scalar in m ²
GPSVelocityNoise	Variance of GPS velocity noise, specified as a scalar in (m/s) ²

References

[1] Abbeel, P., Coates, A., Montemerlo, M., Ng, A.Y. and Thrun, S. Discriminative Training of Kalman Filters. In *Robotics: Science and systems*, Vol. 2, pp. 1, 2005.

See Also

tunerconfig | tunernoise

Introduced in R2021a

insfilterErrorState

Estimate pose from IMU, GPS, and monocular visual odometry (MVO) data

Description

The `insfilterErrorState` object implements sensor fusion of IMU, GPS, and monocular visual odometry (MVO) data to estimate pose in the NED (or ENU) reference frame. The filter uses a 17-element state vector to track the orientation quaternion, velocity, position, IMU sensor biases, and the MVO scaling factor. The `insfilterErrorState` object uses an error-state Kalman filter to estimate these quantities.

Creation

Syntax

```
filter = insfilterErrorState
filter = insfilterErrorState('ReferenceFrame',RF)
filter = insfilterErrorState( ____,Name,Value)
```

Description

`filter = insfilterErrorState` creates an `insfilterErrorState` object with default property values.

`filter = insfilterErrorState('ReferenceFrame',RF)` allows you to specify the reference frame, `RF`, of the filter. Specify `RF` as 'NED' (North-East-Down) or 'ENU' (East-North-Up). The default value is 'NED'.

`filter = insfilterErrorState(____,Name,Value)` also allows you set properties of the created filter using one or more name-value pairs. Enclose each property name in single quotes.

Properties

IMUSampleRate — Sample rate of IMU (Hz)

100 (default) | positive scalar

Sample rate of the inertial measurement unit (IMU) in Hz, specified as a positive scalar.

Data Types: `single` | `double`

ReferenceLocation — Reference location (deg, deg, meters)

[0 0 0] (default) | 3-element positive row vector

Reference location, specified as a 3-element row vector in geodetic coordinates (latitude, longitude, and altitude). Altitude is the height above the reference ellipsoid model, WGS84. The reference location units are [degrees degrees meters].

Data Types: `single` | `double`

GyroscopeNoise — Multiplicative process noise variance from gyroscope ((rad/s)²)

[1e-6 1e-6 1e-6] (default) | scalar | 3-element row vector

Multiplicative process noise variance from the gyroscope in (rad/s)², specified as a scalar or 3-element row vector of positive real finite numbers.

- If **GyroscopeNoise** is specified as a row vector, the elements correspond to the noise in the x, y, and z axes of the gyroscope, respectively.
- If **GyroscopeNoise** is specified as a scalar, the single element is applied to each axis.

Data Types: single | double

GyroscopeBiasNoise — Additive process noise variance from gyroscope bias ((rad/s)²)

[1e-9 1e-9 1e-9] (default) | scalar | 3-element row vector

Additive process noise variance from the gyroscope bias in (rad/s)², specified as a scalar or 3-element row vector of positive real finite numbers.

- If **GyroscopeBiasNoise** is specified as a row vector, the elements correspond to the noise in the x, y, and z axes of the gyroscope, respectively.
- If **GyroscopeBiasNoise** is specified as a scalar, the single element is applied to each axis.

Data Types: single | double

AccelerometerNoise — Multiplicative process noise variance from accelerometer ((m/s²)²)

[1e-4 1e-4 1e-4] (default) | scalar | 3-element row vector

Multiplicative process noise variance from the accelerometer in (m/s²)², specified as a scalar or 3-element row vector of positive real finite numbers.

- If **AccelerometerNoise** is specified as a row vector, the elements correspond to the noise in the x, y, and z axes of the accelerometer, respectively.
- If **AccelerometerNoise** is specified as a scalar, the single element is applied to each axis.

Data Types: single | double

AccelerometerBiasNoise — Additive process noise variance from accelerometer bias ((m/s²)²)

[1e-4 1e-4 1e-4] (default) | scalar | 3-element row vector

Additive process noise variance from accelerometer bias in (m/s²)², specified as a scalar or 3-element row vector of positive real numbers.

- If **AccelerometerBiasNoise** is specified as a row vector, the elements correspond to the noise in the x, y, and z axes of the accelerometer, respectively.
- If **AccelerometerBiasNoise** is specified as a scalar, the single element is applied to each axis.

State — State vector of Kalman filter

[1; zeros(15, 1); 1] (default) | 17-element column vector

State vector of the extended Kalman filter, specified as a 17-element column vector. The state values represent:

State	Units	Index
Orientation (quaternion parts)	N/A	1:4
Position (NED or ENU)	m	5:7
Velocity (NED or ENU)	m/s	8:10
Gyroscope Bias (XYZ)	rad/s	11:13
Accelerometer Bias (XYZ)	m/s ²	14:16
Visual Odometry Scale (XYZ)	N/A	17

The default initial state corresponds to an object at rest located at $[0 \ 0 \ 0]$ in geodetic LLA coordinates.

Data Types: `single` | `double`

StateCovariance — State error covariance for Kalman filter

`ones(16)` (default) | 16-by-16 matrix

State error covariance for the Kalman filter, specified as a 16-by-16-element matrix of real numbers. The state error covariance values represent:

State Covariance	Row/Column Index
δ Rotation Vector (XYZ)	1:3
δ Position (NED or ENU)	4:6
δ Velocity (NED or ENU)	7:9
δ Gyroscope Bias (XYZ)	10:12
δ Accelerometer Bias (XYZ)	13:15
δ Visual Odometry Scale (XYZ)	16

Note that because this is an error-state Kalman filter, it tracks the errors in the states. δ represents the error in the corresponding state.

Data Types: `single` | `double`

Object Functions

<code>predict</code>	Update states using accelerometer and gyroscope data for <code>insfilterErrorState</code>
<code>correct</code>	Correct states using direct state measurements for <code>insfilterErrorState</code>
<code>residual</code>	Residuals and residual covariances from direct state measurements for <code>insfilterErrorState</code>
<code>fusegps</code>	Correct states using GPS data for <code>insfilterErrorState</code>
<code>residualgps</code>	Residuals and residual covariance from GPS measurements for <code>insfilterErrorState</code>
<code>fusemvo</code>	Correct states using monocular visual odometry for <code>insfilterErrorState</code>
<code>residualmvo</code>	Residuals and residual covariance from monocular visual odometry measurements for <code>insfilterErrorState</code>
<code>pose</code>	Current orientation and position estimate for <code>insfilterErrorState</code>
<code>reset</code>	Reset internal states for <code>insfilterErrorState</code>
<code>stateinfo</code>	Display state vector information for <code>insfilterErrorState</code>
<code>tune</code>	Tune <code>insfilterErrorState</code> parameters to reduce estimation error
<code>copy</code>	Create copy of <code>insfilterErrorState</code>

Examples

Estimate Pose of Ground Vehicle

Load logged data of a ground vehicle following a circular trajectory. The .mat file contains IMU and GPS sensor measurements and ground truth orientation and position.

```
load('loggedGroundVehicleCircle.mat', ...
     'imuFs','localOrigin', ...
     'initialStateCovariance', ...
     'accelData','gyroData', ...
     'gpsFs','gpsLLA','Rpos','gpsVel','Rvel', ...
     'trueOrient','truePos');
```

Create an INS filter to fuse IMU and GPS data using an error-state Kalman filter.

```
initialState = [compact(trueOrient(1)),truePos(1,:),-6.8e-3,2.5002,0,zeros(1,6),1].';
filt = insfilterErrorState;
filt.IMUSampleRate = imuFs;
filt.ReferenceLocation = localOrigin;
filt.State = initialState;
filt.StateCovariance = initialStateCovariance;
```

Preallocate variables for position and orientation. Allocate a variable for indexing into the GPS data.

```
numIMUSamples = size(accelData,1);
estOrient = ones(numIMUSamples,1,'quaternion');
estPos = zeros(numIMUSamples,3);

gpsIdx = 1;
```

Fuse accelerometer, gyroscope, and GPS data. The outer loop predicts the filter forward at the fastest sample rate (the IMU sample rate).

```
for idx = 1:numIMUSamples

    % Use predict to estimate the filter state based on the accelData and
    % gyroData arrays.
    predict(filt,accelData(idx,:),gyroData(idx,:));

    % GPS data is collected at a lower sample rate than IMU data. Fuse GPS
    % data at the lower rate.
    if mod(idx, imuFs / gpsFs) == 0
        % Correct the filter states based on the GPS data.
        fusegps(filt,gpsLLA(gpsIdx,:),Rpos,gpsVel(gpsIdx,:),Rvel);
        gpsIdx = gpsIdx + 1;
    end

    % Log the current pose estimate
    [estPos(idx,:), estOrient(idx,:)] = pose(filt);
end
```

Calculate the RMS errors between the known true position and orientation and the output from the error-state filter.

```
pErr = truePos - estPos;
qErr = rad2deg(dist(estOrient,trueOrient));
```

```
pRMS = sqrt(mean(pErr.^2));
qRMS = sqrt(mean(qErr.^2));

fprintf('Position RMS Error\n');
Position RMS Error

fprintf('\tX: %.2f, Y: %.2f, Z: %.2f (meters)\n\n', pRMS(1), pRMS(2), pRMS(3));
\tX: 0.40, Y: 0.24, Z: 0.05 (meters)

fprintf('Quaternion Distance RMS Error\n');
Quaternion Distance RMS Error

fprintf('\t%.2f (degrees)\n\n', qRMS);
\t0.30 (degrees)
```

Visualize the true position and the estimated position.

```
plot(truePos(:,1), truePos(:,2), estPos(:,1), estPos(:,2), 'r:', 'LineWidth', 2)
grid on
axis square
xlabel('N (m)')
ylabel('E (m)')
legend('Ground Truth', 'Estimation')
```

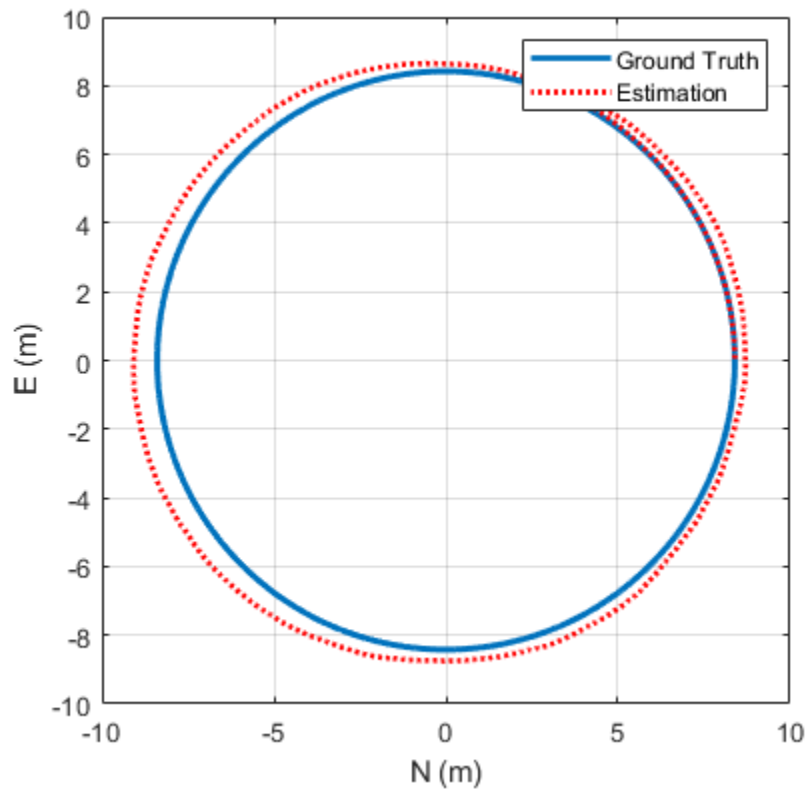

Algorithms

Note: The following algorithm only applies to an NED reference frame.

`insfilterErrorState` uses a 17-axis error state Kalman filter structure to estimate pose in the NED reference frame. The state is defined as:

$$x = \begin{bmatrix} q_0 \\ q_1 \\ q_2 \\ q_3 \\ position_N \\ position_E \\ position_D \\ v_N \\ v_E \\ v_D \\ gyrobias_x \\ gyrobias_y \\ gyrobias_z \\ accelbias_x \\ accelbias_y \\ accelbias_z \\ scaleFactor \end{bmatrix}$$

where

- q_0, q_1, q_2, q_3 -- Parts of orientation quaternion. The orientation quaternion represents a frame rotation from the platform's current orientation to the local NED coordinate system.
- $position_N, position_E, position_D$ -- Position of the platform in the local NED coordinate system.
- $gyrobias_x, gyrobias_y, gyrobias_z$ -- Bias in the gyroscope reading.
- $accelbias_x, accelbias_y, accelbias_z$ -- Bias in the accelerometer reading.
- $scaleFactor$ -- Scale factor of the pose estimate.

Given the conventional formulation of the state transition function,

$$x_{k|k-1} = f(\hat{x}_{k-1|k-1})$$

the predicted state estimate is:

$$x_{k|k-1} =$$

$$\begin{aligned}
 & \left[\begin{array}{l}
 q_0 + \Delta t * q_1(\text{gyrobias}_X/2 - \text{gyro}_X/2) + \Delta t * q_2 * (\text{gyrobias}_Y/2 - \text{gyro}_Y/2) + \Delta t * q_3 * (\text{gyrobias}_Z/2 - \text{gyro}_Z/2) \\
 q_1 - \Delta t * q_0(\text{gyrobias}_X/2 - \text{gyro}_X/2) + \Delta t * q_3 * (\text{gyrobias}_Y/2 - \text{gyro}_Y/2) - \Delta t * q_2 * (\text{gyrobias}_Z/2 - \text{gyro}_Z/2) \\
 q_2 - \Delta t * q_3(\text{gyrobias}_X/2 - \text{gyro}_X/2) - \Delta t * q_0 * (\text{gyrobias}_Y/2 - \text{gyro}_Y/2) + \Delta t * q_1 * (\text{gyrobias}_Z/2 - \text{gyro}_Z/2) \\
 q_3 + \Delta t * q_2(\text{gyrobias}_X/2 - \text{gyro}_X/2) - \Delta t * q_1 * (\text{gyrobias}_Y/2 - \text{gyro}_Y/2) - \Delta t * q_0 * (\text{gyrobias}_Z/2 - \text{gyro}_Z/2)
 \end{array} \right. \\
 & \quad \text{position}_N + \Delta t * v_N \\
 & \quad \text{position}_E + \Delta t * v_E \\
 & \quad \text{position}_D + \Delta t * v_D \\
 & \quad \left. \begin{array}{l}
 v_N - \Delta t * \left[\begin{array}{l}
 q_0 * (q_0 * (\text{accelbias}_X - \text{accel}_X) - q_3 * (\text{accelbias}_Y - \text{accel}_Y) + q_2 * (\text{accelbias}_Z - \text{accel}_Z)) + g_N + \\
 q_2 * (q_1 * (\text{accelbias}_Y - \text{accel}_Y) - q_2 * (\text{accelbias}_X - \text{accel}_X) + q_0 * (\text{accelbias}_Z - \text{accel}_Z)) + \\
 q_1 * (q_1 * (\text{accelbias}_X - \text{accel}_X) + q_2 * (\text{accelbias}_Y - \text{accel}_Y) + q_3 * (\text{accelbias}_Z - \text{accel}_Z)) - \\
 q_3 * (q_3 * (\text{accelbias}_X - \text{accel}_X) + q_0 * (\text{accelbias}_Y - \text{accel}_Y) - q_1 * (\text{accelbias}_Z - \text{accel}_Z))
 \end{array} \right] \\
 v_E - \Delta t * \left[\begin{array}{l}
 q_0 * (q_3 * (\text{accelbias}_X - \text{accel}_X) + q_0 * (\text{accelbias}_Y - \text{accel}_Y) - q_1 * (\text{accelbias}_Z - \text{accel}_Z)) + g_E - \\
 q_1 * (q_1 * (\text{accelbias}_Y - \text{accel}_Y) - q_2 * (\text{accelbias}_X - \text{accel}_X) + q_0 * (\text{accelbias}_Z - \text{accel}_Z)) + \\
 q_2 * (q_1 * (\text{accelbias}_X - \text{accel}_X) + q_2 * (\text{accelbias}_Y - \text{accel}_Y) + q_3 * (\text{accelbias}_Z - \text{accel}_Z)) + \\
 q_3 * (q_0 * (\text{accelbias}_X - \text{accel}_X) - q_3 * (\text{accelbias}_Y - \text{accel}_Y) + q_2 * (\text{accelbias}_Z - \text{accel}_Z))
 \end{array} \right] \\
 q_0 * (q_1 * (\text{accelbias}_Y - \text{accel}_Y) - q_2 * (\text{accelbias}_X - \text{accel}_X) + q_0 * (\text{accelbias}_Z - \text{accel}_Z)) + g_D + \\
 q_1 * (q_2 * (\text{accelbias}_X - \text{accel}_X) - q_3 * (\text{accelbias}_Y - \text{accel}_Y) - q_1 * (\text{accelbias}_Z - \text{accel}_Z)) -
 \end{array} \right.
 \end{aligned}$$

where

- Δt -- IMU sample time.
- g_N, g_E, g_D -- Constant gravity vector in the NED frame.

Extended Capabilities

C/C++ Code Generation

Generate C and C++ code using MATLAB® Coder™.

See Also

[insfilterAsync](#) | [insfilterMARG](#) | [insfilterNonholonomic](#)

Introduced in R2019a

copy

Create copy of `insfilterAsync`

Syntax

```
newFilter = copy(filter)
```

Description

`newFilter = copy(filter)` returns a copy of the `insfilterAsync`, `filter`, that has exactly the same property values.

Input Arguments

filter — Filter to be copied

`insfilterAsync`

Filter to be copied, specified as an `insfilterAsync` object.

Output Arguments

newFilter — New copied filter

`insfilterAsync`

New copied filter, returned as an `insfilterAsync` object.

See Also

`insfilterAsync`

Introduced in R2020b

stateinfo

Display state vector information for `insfilterAsync`

Syntax

```
stateinfo(FUSE)
info = stateinfo(FUSE)
```

Description

`stateinfo(FUSE)` displays the description of each index of the State property of the `insfilterAsync` object and the associated units.

`info = stateinfo(FUSE)` returns a structure with fields containing descriptions of the elements of the state vector of the filter, FUSE.

Examples

State Information of `insfilterAsync`

Create an `insfilterAsync` object.

```
filter = insfilterAsync;
```

Display the state information of the created filter.

```
stateinfo(filter)
```

States	Units	Index
Orientation (quaternion parts)		1:4
Angular Velocity (XYZ)	rad/s	5:7
Position (NAV)	m	8:10
Velocity (NAV)	m/s	11:13
Acceleration (NAV)	m/s ²	14:16
Accelerometer Bias (XYZ)	m/s ²	17:19
Gyroscope Bias (XYZ)	rad/s	20:22
Geomagnetic Field Vector (NAV)	μT	23:25
Magnetometer Bias (XYZ)	μT	26:28

Output the state information of the filter as a structure.

```
info = stateinfo(filter)
```

```
info = struct with fields:
    Orientation: [1 2 3 4]
    AngularVelocity: [5 6 7]
    Position: [8 9 10]
    Velocity: [11 12 13]
    Acceleration: [14 15 16]
    AccelerometerBias: [17 18 19]
    GyroscopeBias: [20 21 22]
```

GeomagneticFieldVector: [23 24 25]
MagnetometerBias: [26 27 28]

Input Arguments

FUSE — **insfilterAsync** object

object

insfilterAsync, specified as an object.

Output Arguments

info — State information

structure

State information, returned as a structure with fields containing descriptions of the elements of the state vector of the filter. The values of each field are the corresponding indices of the state vector.

Extended Capabilities

C/C++ Code Generation

Generate C and C++ code using MATLAB® Coder™.

See Also

insfilter | insfilterAsync

Introduced in R2019a

reset

Reset internal states for `insfilterAsync`

Syntax

```
reset(FUSE)
```

Description

`reset(FUSE)` resets the `State` and `StateCovariance` properties of the `insfilterAsync` object to their default values.

Input Arguments

FUSE — `insfilterAsync` object

object

`insfilterAsync`, specified as an object.

Extended Capabilities

C/C++ Code Generation

Generate C and C++ code using MATLAB® Coder™.

See Also

`insfilter` | `insfilterAsync`

Introduced in R2019a

tune

Tune `insfilterAsync` parameters to reduce estimation error

Syntax

```
tunedMeasureNoise = tune(filter,measureNoise,sensorData,groundTruth)
tunedMeasureNoise = tune(___,config)
```

Description

`tunedMeasureNoise = tune(filter,measureNoise,sensorData,groundTruth)` adjusts the properties of the `insfilterAsync` filter object, `filter`, and measurement noises to reduce the root-mean-squared (RMS) state estimation error between the fused sensor data and the ground truth. The function also returns the tuned measurement noise, `tunedMeasureNoise`. The function uses the property values in the filter and the measurement noise provided in the `measureNoise` structure as the initial estimate for the optimization algorithm.

`tunedMeasureNoise = tune(___,config)` specifies the tuning configuration based on a `tunerconfig` object, `config`.

Examples

Tune `insfilterAsync` to Optimize Pose Estimate

Load the recorded sensor data and ground truth data.

```
load('insfilterAsyncTuneData.mat');
```

Create timetables for the sensor data and the truth data.

```
sensorData = timetable(Accelerometer, Gyroscope, ...
    Magnetometer, GPSPosition, GPSVelocity, 'SampleRate', 100);
groundTruth = timetable(Orientation, Position, ...
    'SampleRate', 100);
```

Create an `insfilterAsync` filter object that has a few noise properties.

```
filter = insfilterAsync('State', initialState, ...
    'StateCovariance', initialStateCovariance, ...
    'AccelerometerBiasNoise', 1e-7, ...
    'GyroscopeBiasNoise', 1e-7, ...
    'MagnetometerBiasNoise', 1e-7, ...
    'GeomagneticVectorNoise', 1e-7);
```

Create a tuner configuration object for the filter. Set the maximum iterations to two. Also, set the tunable parameters as the unspecified properties.

```
config = tunerconfig('insfilterAsync','MaxIterations',8);
config.TunableParameters = setdiff(config.TunableParameters, ...
    {'GeomagneticVectorNoise', 'AccelerometerBiasNoise', ...
```

```

    'GyroscopeBiasNoise', 'MagnetometerBiasNoise'}));
config.TunableParameters
ans = 1x10 string
    "AccelerationNoise"    "AccelerometerNoise"    "AngularVelocityNoise"    "GPSPositionNoise"

```

Use the tuner noise function to obtain a set of initial sensor noises used in the filter.

```
measNoise = tunernoise('insfilterAsync')
```

```
measNoise = struct with fields:
```

```

    AccelerometerNoise: 1
      GyroscopeNoise: 1
    MagnetometerNoise: 1
    GPSPositionNoise: 1
    GPSVelocityNoise: 1

```

Tune the filter and obtain the tuned parameters.

```
tunedParams = tune(filter,measNoise,sensorData,groundTruth,config);
```

Iteration	Parameter	Metric
1	AccelerationNoise	2.1345
1	AccelerometerNoise	2.1264
1	AngularVelocityNoise	1.9659
1	GPSPositionNoise	1.9341
1	GPSVelocityNoise	1.8420
1	GyroscopeNoise	1.7589
1	MagnetometerNoise	1.7362
1	PositionNoise	1.7362
1	QuaternionNoise	1.7218
1	VelocityNoise	1.7218
2	AccelerationNoise	1.7190
2	AccelerometerNoise	1.7170
2	AngularVelocityNoise	1.6045
2	GPSPositionNoise	1.5948
2	GPSVelocityNoise	1.5323
2	GyroscopeNoise	1.4803
2	MagnetometerNoise	1.4703
2	PositionNoise	1.4703
2	QuaternionNoise	1.4632
2	VelocityNoise	1.4632
3	AccelerationNoise	1.4596
3	AccelerometerNoise	1.4548
3	AngularVelocityNoise	1.3923
3	GPSPositionNoise	1.3810
3	GPSVelocityNoise	1.3322
3	GyroscopeNoise	1.2998
3	MagnetometerNoise	1.2976
3	PositionNoise	1.2976
3	QuaternionNoise	1.2943
3	VelocityNoise	1.2943
4	AccelerationNoise	1.2906
4	AccelerometerNoise	1.2836
4	AngularVelocityNoise	1.2491
4	GPSPositionNoise	1.2258

4	GPSVelocityNoise	1.1880
4	GyroscopeNoise	1.1701
4	MagnetometerNoise	1.1698
4	PositionNoise	1.1698
4	QuaternionNoise	1.1688
4	VelocityNoise	1.1688
5	AccelerationNoise	1.1650
5	AccelerometerNoise	1.1569
5	AngularVelocityNoise	1.1454
5	GPSPositionNoise	1.1100
5	GPSVelocityNoise	1.0778
5	GyroscopeNoise	1.0709
5	MagnetometerNoise	1.0675
5	PositionNoise	1.0675
5	QuaternionNoise	1.0669
5	VelocityNoise	1.0669
6	AccelerationNoise	1.0634
6	AccelerometerNoise	1.0549
6	AngularVelocityNoise	1.0549
6	GPSPositionNoise	1.0180
6	GPSVelocityNoise	0.9866
6	GyroscopeNoise	0.9810
6	MagnetometerNoise	0.9775
6	PositionNoise	0.9775
6	QuaternionNoise	0.9768
6	VelocityNoise	0.9768
7	AccelerationNoise	0.9735
7	AccelerometerNoise	0.9652
7	AngularVelocityNoise	0.9652
7	GPSPositionNoise	0.9283
7	GPSVelocityNoise	0.8997
7	GyroscopeNoise	0.8947
7	MagnetometerNoise	0.8920
7	PositionNoise	0.8920
7	QuaternionNoise	0.8912
7	VelocityNoise	0.8912
8	AccelerationNoise	0.8885
8	AccelerometerNoise	0.8811
8	AngularVelocityNoise	0.8807
8	GPSPositionNoise	0.8479
8	GPSVelocityNoise	0.8238
8	GyroscopeNoise	0.8165
8	MagnetometerNoise	0.8165
8	PositionNoise	0.8165
8	QuaternionNoise	0.8159
8	VelocityNoise	0.8159

Fuse the sensor data using the tuned filter.

```
dt = seconds(diff(groundTruth.Time));
N = size(sensorData,1);
qEst = quaternion.zeros(N,1);
posEst = zeros(N,3);
% Iterate the filter for prediction and correction using sensor data.
for ii=1:N
    if ii ~= 1
        predict(filter, dt(ii-1));
    end
end
```



```

if all(~isnan(Accelerometer(ii,:)))
    fuseaccel(filter, Accelerometer(ii,:), ...
              tunedParams.AccelerometerNoise);
end
if all(~isnan(Gyroscope(ii,:)))
    fusegyro(filter, Gyroscope(ii,:), ...
             tunedParams.GyroscopeNoise);
end
if all(~isnan(Magnetometer(ii,1)))
    fusemag(filter, Magnetometer(ii,:), ...
            tunedParams.MagnetometerNoise);
end
if all(~isnan(GPSPosition(ii,1)))
    fusegps(filter, GPSPosition(ii,:), ...
            tunedParams.GPSPositionNoise, GPSVelocity(ii,:), ...
            tunedParams.GPSVelocityNoise);
end
[posEst(ii,:), qEst(ii,:)] = pose(filter);
end

```

Compute the RMS errors.

```

orientationError = rad2deg(dist(qEst, Orientation));
rmsorientationError = sqrt(mean(orientationError.^2))

```

```

rmsorientationError = 2.7801

```

```

positionError = sqrt(sum((posEst - Position).^2, 2));
rmspositionError = sqrt(mean( positionError.^2))

```

```

rmspositionError = 0.5966

```

Visualize the results.

```

figure();
t = (0:N-1)./ groundTruth.Properties.SampleRate;
subplot(2,1,1)
plot(t, positionError, 'b');
title("Tuned insfilterAsync" + newline + "Euclidean Distance Position Error")
xlabel('Time (s)');
ylabel('Position Error (meters)')
subplot(2,1,2)
plot(t, orientationError, 'b');
title("Orientation Error")
xlabel('Time (s)');
ylabel('Orientation Error (degrees)');

```

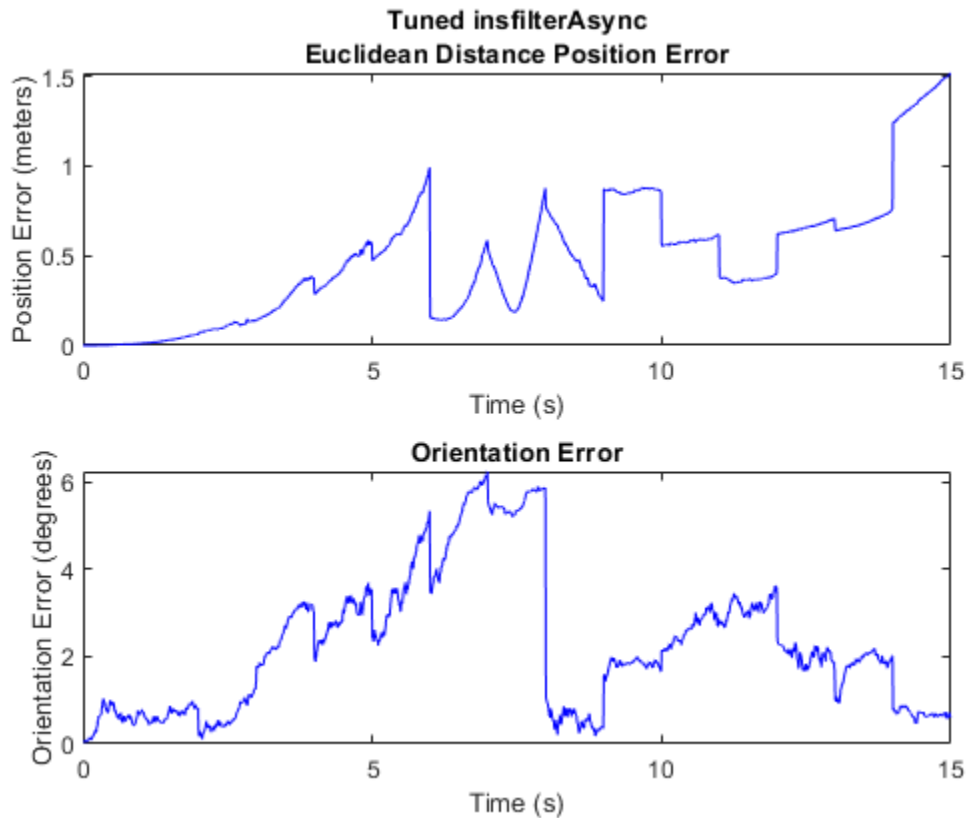

Input Arguments

filter – Filter object
`insfilterAsync` object

Filter object, specified as an `insfilterAsync` object.

measureNoise – Measurement noise
 structure

Measurement noise, specified as a structure. The function uses the measurement noise input as the initial guess for tuning the measurement noise. The structure must contain these fields:

Field name	Description
<code>AccelerometerNoise</code>	Variance of accelerometer noise, specified as a scalar in (m^2/s)
<code>GyroscopeNoise</code>	Variance of gyroscope noise, specified as a scalar in $(\text{rad}/\text{s})^2$
<code>MagnetometerNoise</code>	Variance of magnetometer noise, specified as a scalar in $(\mu\text{T})^2$
<code>GPSPositionNoise</code>	Variance of GPS position noise, specified as a scalar in m^2

Field name	Description
GPSVelocityNoise	Variance of GPS velocity noise, specified as a scalar in (m/s) ²

sensorData — Sensor data

duration

Sensor data, specified as a timetable. In each row, the time and sensor data is specified as:

- **Time** — Time at which the data is obtained, specified as a scalar in seconds.
- **Accelerometer** — Accelerometer data, specified as a 1-by-3 vector of scalars in m²/s.
- **Gyroscope** — Gyroscope data, specified as a 1-by-3 vector of scalars in rad/s.
- **Magnetometer** — Magnetometer data, specified as a 1-by-3 vector of scalars in μ T.
- **GPSPosition** — GPS position data, specified as a 1-by-3 vector of scalars in meters.
- **GPSVelocity** — GPS velocity data, specified as a 1-by-3 vector of scalars in m/s.

If a sensor does not produce measurements, specify the corresponding entry as NaN. If you set the **Cost** property of the tuner configuration input, **config**, to **Custom**, then you can use other data types for the **sensorData** input based on your choice.

groundTruth — Ground truth data

duration

Ground truth data, specified as a timetable. In each row, the table can optionally contain any of these variables:

- **Orientation** — Orientation from the navigation frame to the body frame, specified as a quaternion or a 3-by-3 rotation matrix.
- **AngularVelocity** — Angular velocity in body frame, specified as a 1-by-3 vector of scalars in rad/s.
- **Position** — Position in navigation frame, specified as a 1-by-3 vector of scalars in meters.
- **Velocity** — Velocity in navigation frame, specified as a 1-by-3 vector of scalars in m/s.
- **Acceleration** — Acceleration in navigation frame, specified as a 1-by-3 vector of scalars in m²/s.
- **AccelerometerBias** — Accelerometer delta angle bias in body frame, specified as a 1-by-3 vector of scalars in m²/s.
- **GyroscopeBias** — Gyroscope delta angle bias in body frame, specified as a 1-by-3 vector of scalars in rad/s.
- **GeomagneticFieldVector** — Geomagnetic field vector in navigation frame, specified as a 1-by-3 vector of scalars.
- **MagnetometerBias** — Magnetometer bias in body frame, specified as a 1-by-3 vector of scalars in μ T.

The function processes each row of the **sensorData** and **groundTruth** tables sequentially to calculate the state estimate and RMS error from the ground truth. State variables not present in **groundTruth** input are ignored for the comparison. The **sensorData** and the **groundTruth** tables must have the same time steps.

If you set the **Cost** property of the tuner configuration input, **config**, to **Custom**, then you can use other data types for the **groundTruth** input based on your choice.

config – Tuner configuration

tunerconfig object

Tuner configuration, specified as a tunerconfig object.

Output Arguments**tunedMeasureNoise – Tuned measurement noise**

structure

Tuned measurement noise, returned as a structure. The structure contains these fields.

Field name	Description
AccelerometerNoise	Variance of accelerometer noise, specified as a scalar in $(\text{m}^2/\text{s})^2$
GyroscopeNoise	Variance of gyroscope noise, specified as a scalar in $(\text{rad}/\text{s})^2$
MagnetometerNoise	Variance of magnetometer noise, specified as a scalar in $(\mu\text{T})^2$
GPSPositionNoise	Variance of GPS position noise, specified as a scalar in m^2
GPSVelocityNoise	Variance of GPS velocity noise, specified as a scalar in $(\text{m}/\text{s})^2$

References

- [1] Abbeel, P., Coates, A., Montemerlo, M., Ng, A.Y. and Thrun, S. Discriminative Training of Kalman Filters. In *Robotics: Science and systems*, Vol. 2, pp. 1, 2005.

See Also

tunerconfig | tunernoise

Introduced in R2020b

predict

Update states based on motion model for `insfilterAsync`

Syntax

```
predict(FUSE,dt)
```

Description

`predict(FUSE,dt)` updates states based on the motion model.

Input Arguments

FUSE — `insfilterAsync` object

object

`insfilterAsync`, specified as an object.

dt — Delta time to propagate forward (s)

scalar

Delta time to propagate forward in seconds, specified as a positive scalar.

Data Types: `single` | `double`

Extended Capabilities

C/C++ Code Generation

Generate C and C++ code using MATLAB® Coder™.

See Also

`insfilter` | `insfilterAsync`

Introduced in R2019a

pose

Current position, orientation, and velocity estimate for `insfilterAsync`

Syntax

```
[position,orientation,velocity] = pose(FUSE)
[position,orientation,velocity] = pose(FUSE,format)
```

Description

`[position,orientation,velocity] = pose(FUSE)` returns the current estimate of the pose.

`[position,orientation,velocity] = pose(FUSE,format)` returns the current estimate of the pose with orientation in the specified orientation format.

Input Arguments

FUSE — `insfilterAsync` object

object

`insfilterAsync`, specified as an object.

format — Output orientation format

'quaternion' (default) | 'rotmat'

Output orientation format, specified as either 'quaternion' for a quaternion or 'rotmat' for a rotation matrix.

Data Types: char | string

Output Arguments

position — Position estimate in the local NED coordinate system (m)

3-element row vector

Position estimate in the local NED coordinate system in meters, returned as a 3-element row vector.

Data Types: single | double

orientation — Orientation estimate in the local NED coordinate system

quaternion (default) | 3-by-3 rotation matrix

Orientation estimate in the local NED coordinate system, returned as a scalar quaternion or 3-by-3 rotation matrix, depending on the specified orientation format. The quaternion or rotation matrix represents a frame rotation from the local NED reference frame to the body reference frame.

Data Types: single | double | quaternion

velocity — Velocity estimate in the local NED coordinate system (m/s)

3-element row vector

Velocity estimate in the local NED coordinate system in m/s, returned as a 3-element row vector.

Data Types: `single` | `double`

Extended Capabilities

C/C++ Code Generation

Generate C and C++ code using MATLAB® Coder™.

See Also

`insfilter` | `insfilterAsync`

Introduced in R2019a

fusemag

Correct states using magnetometer data for `insfilterAsync`

Syntax

```
[res, resCov] = fusemag(FUSE, magReadings, magReadingsCovariance)
```

Description

`[res, resCov] = fusemag(FUSE, magReadings, magReadingsCovariance)` fuses magnetometer data to correct the state estimate.

Input Arguments

FUSE — `insfilterAsync` object

object

`insfilterAsync`, specified as an object.

magReadings — Magnetometer readings (μT)

3-element row vector

Magnetometer readings in μT , specified as a 3-element row vector of finite real numbers.

Data Types: `single` | `double`

magReadingsCovariance — Magnetometer readings error covariance (μT^2)

scalar | 3-element row vector | 3-by-3 matrix

Magnetometer readings error covariance in μT^2 , specified as a scalar, 3-element row vector, or 3-by-3 matrix.

Data Types: `single` | `double`

Output Arguments

res — Residual

1-by-3 vector of real values

Residual, returned a 1-by-3 vector of real values in μT .

Data Types: `single` | `double`

resCov — Residual covariance

3-by-3 matrix of real values

Residual covariance, returned a 3-by-3 matrix of real values in $(\mu\text{T})^2$.

Extended Capabilities

C/C++ Code Generation

Generate C and C++ code using MATLAB® Coder™.

See Also

`insfilter` | `insfilterAsync`

Introduced in R2019a

residualmag

Residuals and residual covariance from magnetometer measurements for `insfilterAsync`

Syntax

```
[res,resCov] = residualmag(FUSE,magReadings,magReadingsCovariance)
```

Description

`[res,resCov] = residualmag(FUSE,magReadings,magReadingsCovariance)` computes the residual, `residual`, and the residual covariance, `resCov`, based on the magnetometer readings and the corresponding covariance.

Input Arguments

FUSE — `insfilterAsync`

`ahrs10filter` | object

`insfilterAsync`, specified as an object.

magReadings — Magnetometer readings (μT)

3-element row vector

Magnetometer readings in μT , specified as a 3-element row vector of finite real numbers.

Data Types: `single` | `double`

magReadingsCovariance — Magnetometer readings error covariance (μT^2)

scalar | 3-element row vector | 3-by-3 matrix

Magnetometer readings error covariance in μT^2 , specified as a scalar, 3-element row vector, or 3-by-3 matrix.

Data Types: `single` | `double`

Output Arguments

res — Residual

1-by-3 vector of real values

Residual, returned as a 1-by-3 vector of real values in μT .

Data Types: `single` | `double`

resCov — Residual covariance

3-by-3 matrix of real values

Residual covariance, returned a 3-by-3 matrix of real values in $(\mu\text{T})^2$.

Extended Capabilities

C/C++ Code Generation

Generate C and C++ code using MATLAB® Coder™.

See Also

`insfilterAsync`

Introduced in R2020a

fusegyro

Correct states using gyroscope data for `insfilterAsync`

Syntax

```
[res,resCov] = fusegyro(FUSE,gyroReadings,gyroCovariance)
```

Description

`[res,resCov] = fusegyro(FUSE,gyroReadings,gyroCovariance)` fuses gyroscope data to correct the state estimate.

Input Arguments

FUSE — `insfilterAsync` object

object

`insfilterAsync`, specified as an object.

gyroReadings — Gyroscope readings in local sensor body coordinate system (rad/s)

3-element row vector

Gyroscope readings in local sensor body coordinate system in rad/s, specified as a 3-element row vector.

Data Types: `single` | `double`

gyroCovariance — Covariance of gyroscope measurement error ((rad/s)²)

scalar | 3-element row vector | 3-by-3 matrix

Covariance of gyroscope measurement error in (rad/s)², specified as a scalar, 3-element row vector, or 3-by-3 matrix.

Data Types: `single` | `double`

Output Arguments

res — Residual

1-by-3 vector of real values

Residual, returned as a 1-by-3 vector of real values in rad/s.

resCov — Residual covariance

3-by-3 matrix of real values

Residual covariance, returned as a 3-by-3 matrix of real values in (rad/s)².

Extended Capabilities

C/C++ Code Generation

Generate C and C++ code using MATLAB® Coder™.

See Also

`insfilter` | `insfilterAsync`

Introduced in R2019a

residualgyro

Residuals and residual covariance from gyroscope measurements for `insfilterAsync`

Syntax

```
[res,resCov] = residualgyro(FUSE,gyroReadings,gyroCovariance)
```

Description

`[res,resCov] = residualgyro(FUSE,gyroReadings,gyroCovariance)` computes the residual, `res`, and the innovation covariance, `resCov`, based on the gyroscope readings and the corresponding covariance.

Input Arguments

FUSE — `insfilterAsync`

`ahrs10filter` | object

`insfilterAsync`, specified as an object.

gyroReadings — Gyroscope readings in local sensor body coordinate system (rad/s)

3-element row vector

Gyroscope readings in local sensor body coordinate system in rad/s, specified as a 3-element row vector.

Data Types: `single` | `double`

gyroCovariance — Covariance of gyroscope measurement error ((rad/s)²)

scalar | 3-element row vector | 3-by-3 matrix

Covariance of gyroscope measurement error in (rad/s)², specified as a scalar, 3-element row vector, or 3-by-3 matrix.

Data Types: `single` | `double`

Output Arguments

res — Residual

1-by-3 vector of real values

Residual, returned as a 1-by-3 vector of real values in rad/s.

resCov — Residual covariance

3-by-3 matrix of real values

Residual covariance, returned as a 3-by-3 matrix of real values in (rad/s)².

Extended Capabilities

C/C++ Code Generation

Generate C and C++ code using MATLAB® Coder™.

See Also

`insfilter` | `insfilterAsync`

Introduced in R2020a

fusegps

Correct states using GPS data for `insfilterAsync`

Syntax

```
[res,resCov] = fusegps(FUSE,position,positionCovariance)
[res,resCov] = fusegps(FUSE,position,positionCovariance,velocity,
velocityCovariance)
```

Description

`[res,resCov] = fusegps(FUSE,position,positionCovariance)` fuses GPS position data to correct the state estimate.

`[res,resCov] = fusegps(FUSE,position,positionCovariance,velocity,velocityCovariance)` fuses GPS position and velocity data to correct the state estimate.

Input Arguments

FUSE — `insfilterAsync` object

object

`insfilterAsync`, specified as an object.

position — Position of GPS receiver (LLA)

3-element row vector

Position of GPS receiver in geodetic latitude, longitude, and altitude (LLA) specified as a real finite 3-element row vector. Latitude and longitude are in degrees with north and east being positive. Altitude is in meters.

Data Types: `single` | `double`

positionCovariance — Position measurement covariance of GPS receiver (m²)

3-by-3 matrix

Position measurement covariance of GPS receiver in m², specified as a 3-by-3 matrix.

Data Types: `single` | `double`

velocity — Velocity of GPS receiver in local NED coordinate system (m/s)

3-element row vector

Velocity of the GPS receiver in the local NED coordinate system in m/s, specified as a 3-element row vector.

Data Types: `single` | `double`

velocityCovariance — Velocity measurement covariance of GPS receiver (m/s²)

3-by-3 matrix

Velocity measurement covariance of the GPS receiver in the local NED coordinate system in m/s^2 , specified as a 3-by-3 matrix.

Data Types: `single` | `double`

Output Arguments

res — Position and velocity residual

1-by-6 vector of real values

Position and velocity residual, returned as a 1-by-6 vector of real values in m and m/s, respectively.

resCov — Residual covariance

6-by-6 matrix of real values

Residual covariance, returned as a 6-by-6 matrix of real values.

Extended Capabilities

C/C++ Code Generation

Generate C and C++ code using MATLAB® Coder™.

See Also

`insfilter` | `insfilterAsync` | `insfilterMARG`

Introduced in R2019a

fuseaccel

Correct states using accelerometer data for `insfilterAsync`

Syntax

```
[res,resCov] = fuseaccel(FUSE,acceleration,accelerationCovariance)
```

Description

`[res,resCov] = fuseaccel(FUSE,acceleration,accelerationCovariance)` fuses accelerometer data to correct the state estimate.

Input Arguments

FUSE — `insfilterAsync` object

object

`insfilterAsync`, specified as an object.

acceleration — Accelerometer readings in local sensor body coordinate system (m/s²)

3-element row vector

Accelerometer readings in local sensor body coordinate system in m/s², specified as a 3-element row vector

Data Types: `single` | `double`

accelerationCovariance — Acceleration error covariance of accelerometer measurement ((m/s²)²)

scalar | 3-element row vector | 3-by-3 matrix

Acceleration error covariance of the accelerometer measurement in (m/s²)², specified as a scalar, 3-element row vector, or 3-by-3 matrix.

Data Types: `single` | `double`

Output Arguments

res — Residual

1-by-3 vector of real values

Residual, returned a 1-by-3 vector of real values in m/s².

resCov — Residual covariance

3-by-3 matrix of real values

Residual covariance, returned as a 3-by-3 matrix of real values in (m/s²)².

Extended Capabilities

C/C++ Code Generation

Generate C and C++ code using MATLAB® Coder™.

See Also

`insfilter` | `insfilterAsync`

Introduced in R2019a

residualaccel

Residuals and residual covariance from accelerometer measurements for `insfilterAsync`

Syntax

```
[res,resCov] = residualaccel(FUSE,acceleration,accelerationCovariance)
```

Description

```
[res,resCov] = residualaccel(FUSE,acceleration,accelerationCovariance)
```

computes the residual, `res`, and the residual covariance, `resCov`, based on the acceleration readings and the corresponding covariance.

Input Arguments

FUSE — `insfilterAsync`

`ahrs10filter` | object

`insfilterAsync`, specified as an object.

acceleration — Accelerometer readings in local sensor body coordinate system (m/s²)

3-element row vector

Accelerometer readings in local sensor body coordinate system in m/s², specified as a 3-element row vector

Data Types: `single` | `double`

accelerationCovariance — Acceleration error covariance of accelerometer measurement ((m/s²)²)

scalar | 3-element row vector | 3-by-3 matrix

Acceleration error covariance of the accelerometer measurement in (m/s²)², specified as a scalar, 3-element row vector, or 3-by-3 matrix.

Data Types: `single` | `double`

Output Arguments

res — Residual

1-by-3 vector of real values

Residual, returned a 1-by-3 vector of real values in m/s².

resCov — Residual covariance

3-by-3 matrix of real values

Residual covariance, returned a 3-by-3 matrix of real values in (m/s²)².

Extended Capabilities

C/C++ Code Generation

Generate C and C++ code using MATLAB® Coder™.

See Also

`insfilter` | `insfilterAsync`

Introduced in R2020a

correct

Correct states using direct state measurements for `insfilterAsync`

Syntax

```
correct(FUSE, idx, measurement, measurementCovariance)
```

Description

`correct(FUSE, idx, measurement, measurementCovariance)` corrects the state and state estimation error covariance based on the measurement and measurement covariance. The measurement maps directly to the state specified by the indices `idx`.

Input Arguments

FUSE — `insfilterAsync` object

object

`insfilterAsync`, specified as an object.

idx — State vector index of measurement to correct

N -element vector of increasing integers in the range [1, 28]

State vector index of measurement to correct, specified as an N -element vector of increasing integers in the range [1, 28].

The state values represent:

State	Units	Index
Orientation (quaternion parts)	N/A	1:4
Angular Velocity (XYZ)	rad/s	5:7
Position (NED)	m	8:10
Velocity (NED)	m/s	11:13
Acceleration (NED)	m/s ²	14:16
Accelerometer Bias (XYZ)	m/s ²	17:19
Gyroscope Bias (XYZ)	rad/s	20:22
Geomagnetic Field Vector (NED)	μT	23:25
Magnetometer Bias (XYZ)	μT	26:28

Data Types: `single` | `double`

measurement — Direct measurement of state

N -element vector

Direct measurement of state, specified as an N -element vector. N is the number of elements of the index argument, `idx`.

Data Types: `single` | `double`

measurementCovariance — Covariance of measurement

scalar | N -element vector | N -by- N matrix

Covariance of measurement, specified as a scalar, N -element vector, or N -by- N matrix. N is the number of elements of the index argument, `idx`.

Data Types: `single` | `double`

Extended Capabilities

C/C++ Code Generation

Generate C and C++ code using MATLAB® Coder™.

See Also

`insfilter` | `insfilterAsync`

Introduced in R2019a

residual

Residuals and residual covariances from direct state measurements for `insfilterAsync`

Syntax

```
[res, resCov]= residual(FUSE,idx,measurement,measurementCovariance)
```

Description

`[res, resCov]= residual(FUSE,idx,measurement,measurementCovariance)` computes the residual, `res`, and the residual covariance, `resCov`, based on the direct state measurement and measurement covariance. The measurement maps directly to the states specified by indices, `idx`.

Input Arguments

FUSE — `insfilterAsync`

`ahrs10filter` | object

`insfilterAsync`, specified as an object.

idx — State vector index of measurement to correct

N -element vector of increasing integers in the range [1, 28]

State vector index of measurement to correct, specified as an N -element vector of increasing integers in the range [1, 28].

The state values represent:

State	Units	Index
Orientation (quaternion parts)	N/A	1:4
Angular Velocity (XYZ)	rad/s	5:7
Position (NED)	m	8:10
Velocity (NED)	m/s	11:13
Acceleration (NED)	m/s ²	14:16
Accelerometer Bias (XYZ)	m/s ²	17:19
Gyroscope Bias (XYZ)	rad/s	20:22
Geomagnetic Field Vector (NED)	μT	23:25
Magnetometer Bias (XYZ)	μT	26:28

Data Types: `single` | `double`

measurement — Direct measurement of state

N -element vector

Direct measurement of state, specified as a N -element vector. N is the number of elements of the index argument, `idx`.

measurementCovariance — Covariance of measurement*N*-by-*N* matrix

Covariance of measurement, specified as an *N*-by-*N* matrix. *N* is the number of elements of the index argument, `idx`.

Output Arguments**res — Measurement residual**1-by-*N* vector of real values

Measurement residual, returned as a 1-by-*N* vector of real values.

resCov — Residual covariance*N*-by-*N* matrix of real values

Residual covariance, returned as a *N*-by-*N* matrix of real values.

Extended Capabilities**C/C++ Code Generation**

Generate C and C++ code using MATLAB® Coder™.

See Also`insfilterAsync`**Introduced in R2020a**

residualgps

Residuals and residual covariance from GPS measurements for `insfilterAsync`

Syntax

```
[res,resCov] = residualgps(FUSE,position,positionCovariance)
[res,resCov] = residualgps(FUSE,position,positionCovariance,velocity,
velocityCovariance)
```

Description

`[res,resCov] = residualgps(FUSE,position,positionCovariance)` computes the residual, `res`, and the residual covariance, `resCov`, based on the GPS position measurement and covariance.

`[res,resCov] = residualgps(FUSE,position,positionCovariance,velocity,velocityCovariance)` computes the residual, `res`, and the residual covariance, `resCov`, based on the GPS position measurement and covariance.

Input Arguments

FUSE — `insfilterAsync`

`ahrs10filter` | object

`insfilterAsync`, specified as an object.

position — Position of GPS receiver (LLA)

3-element row vector

Position of GPS receiver in geodetic latitude, longitude, and altitude (LLA) specified as a real finite 3-element row vector. Latitude and longitude are in degrees with north and east being positive. Altitude is in meters.

Data Types: `single` | `double`

positionCovariance — Position measurement covariance of GPS receiver (m²)

3-by-3 matrix

Position measurement covariance of GPS receiver in m², specified as a 3-by-3 matrix.

Data Types: `single` | `double`

velocity — Velocity of GPS receiver in local NED coordinate system (m/s)

3-element row vector

Velocity of the GPS receiver in the local NED coordinate system in m/s, specified as a 3-element row vector.

Data Types: `single` | `double`

velocityCovariance — Velocity measurement covariance of GPS receiver (m/s²)

3-by-3 matrix

Velocity measurement covariance of the GPS receiver in the local NED coordinate system in m/s^2 , specified as a 3-by-3 matrix.

Data Types: `single` | `double`

Output Arguments

res — Position and velocity residual

1-by-3 vector of real values | 1-by-6 vector of real values

Position and velocity residual, returned as a 1-by-3 vector of real values if the inputs only contain position information, and returned as 1-by-6 vector of real values if the inputs also contain velocity information.

resCov — Residual covariance

3-by-3 matrix of real values | 6-by-6 matrix of real values

Residual covariance, returned as a 3-by-3 matrix of real values if the inputs only contain position information, and a 6-by-6 matrix of real values if the inputs also contain velocity information.

Extended Capabilities

C/C++ Code Generation

Generate C and C++ code using MATLAB® Coder™.

See Also

`insfilterAsync`

Introduced in R2020a

insfilterAsync

Estimate pose from asynchronous MARG and GPS data

Description

The `insfilterAsync` object implements sensor fusion of MARG and GPS data to estimate pose in the NED (or ENU) reference frame. MARG (magnetic, angular rate, gravity) data is typically derived from magnetometer, gyroscope, and accelerometer data, respectively. The filter uses a 28-element state vector to track the orientation quaternion, velocity, position, MARG sensor biases, and geomagnetic vector. The `insfilterAsync` object uses a continuous-discrete extended Kalman filter to estimate these quantities.

Creation

Syntax

```
filter = insfilterAsync
filter = insfilterAsync('ReferenceFrame',RF)
filter = insfilterAsync( ____,Name,Value)
```

Description

`filter = insfilterAsync` creates an `insfilterAsync` object to fuse asynchronous MARG and GPS data with default property values.

`filter = insfilterAsync('ReferenceFrame',RF)` allows you to specify the reference frame, RF, of the filter. Specify RF as 'NED' (North-East-Down) or 'ENU' (East-North-Up). The default value is 'NED'.

`filter = insfilterAsync(____,Name,Value)` also allows you set properties of the created filter using one or more name-value pairs. Enclose each property name in single quotes.

Properties

ReferenceLocation — Reference location (deg, deg, meters)

[0 0 0] (default) | three-element positive row vector

Reference location, specified as a three-element row vector in geodetic coordinates (latitude, longitude, and altitude). Altitude is the height above the reference ellipsoid model, WGS84. The reference location units are [degrees degrees meters].

Data Types: `single` | `double`

QuaternionNoise — Additive quaternion process noise variance

[1e-6 1e-6 1e-6 1e-6] (default) | scalar | four-element row vector

Additive quaternion process noise variance, specified as a scalar or four-element vector of quaternion parts.

Data Types: single | double

AngularVelocityNoise — Additive angular velocity process noise in local navigation coordinate system ((rad/s)²)

[0.005 0.005 0.005] (default) | scalar | three-element row vector

Additive angular velocity process noise in the local navigation coordinate system in (rad/s)², specified as a scalar or three-element row vector of positive real finite numbers.

- If **AngularVelocityNoise** is a row vector, the elements correspond to the noise in the x , y , and z axes of the local navigation coordinate system, respectively.
- If **AngularVelocityNoise** is a scalar, the single element is applied to each axis.

Data Types: single | double

PositionNoise — Additive position process noise variance in local navigation coordinate system (m²)

[1e-6 1e-6 1e-6] (default) | scalar | three-element row vector

Additive position process noise in the local navigation coordinate system in m², specified as a scalar or three-element row vector of positive real finite numbers.

- If **PositionNoise** is a row vector, the elements correspond to the noise in the x , y , and z axes of the local navigation coordinate system, respectively.
- If **PositionNoise** is a scalar, the single element is applied to each axis.

Data Types: single | double

VelocityNoise — Additive velocity process noise variance in local navigation coordinate system ((m/s)²)

[1e-6 1e-6 1e-6] (default) | scalar | three-element row vector

Additive velocity process noise in the local navigation coordinate system in (m/s)², specified as a scalar or three-element row vector of positive real finite numbers.

- If **VelocityNoise** is a row vector, the elements correspond to the noise in the x , y , and z axes of the local navigation coordinate system, respectively.
- If **VelocityNoise** is a scalar, the single element is applied to each axis.

Data Types: single | double

AccelerationNoise — Additive acceleration process noise variance in local navigation coordinate system ((m/s²)²)

[50 50 50] (default) | scalar | three-element row vector

Additive acceleration process noise in (m/s²)², specified as a scalar or three-element row vector of positive real finite numbers.

- If **AccelerationNoise** is a row vector, the elements correspond to the noise in the x , y , and z axes of the local navigation coordinate system, respectively.
- If **AccelerationNoise** is a scalar, the single element is applied to each axis.

Data Types: single | double

GyroscopeBiasNoise — Additive process noise variance from gyroscope bias ((rad/s)²)

[1e-10 1e-10 1e-10] (default) | scalar | three-element row vector

Additive process noise variance from the gyroscope bias in (rad/s)², specified as a scalar or three-element row vector of positive real finite numbers.

- If GyroscopeBiasNoise is a row vector, the elements correspond to the noise in the x, y, and z axes of the gyroscope, respectively.
- If GyroscopeBiasNoise is a scalar, the single element is applied to each axis.

Data Types: single | double

AccelerometerBiasNoise — Additive process noise variance from accelerometer bias ((m/s²)²)

[1e-4 1e-4 1e-4] (default) | positive scalar | three-element row vector

Additive process noise variance from accelerometer bias in (m/s²)², specified as a scalar or three-element row vector of positive real numbers.

- If AccelerometerBiasNoise is a row vector, the elements correspond to the noise in the x, y, and z axes of the accelerometer, respectively.
- If AccelerometerBiasNoise is a scalar, the single element is applied to each axis.

GeomagneticVectorNoise — Additive process noise variance of geomagnetic vector in local navigation coordinate system (μT²)

[1e-6 1e-6 1e-6] (default) | positive scalar | three-element row vector

Additive process noise variance of geomagnetic vector in μT², specified as a scalar or three-element row vector of positive real numbers.

- If GeomagneticVectorNoise is a row vector, the elements correspond to the noise in the x, y, and z axes of the local navigation coordinate system, respectively.
- If GeomagneticVectorNoise is a scalar, the single element is applied to each axis.

MagnetometerBiasNoise — Additive process noise variance from magnetometer bias (μT²)

[0.1 0.1 0.1] (default) | positive scalar | three-element row vector

Additive process noise variance from magnetometer bias in μT², specified as a scalar or three-element row vector of positive real numbers.

- If MagnetometerBiasNoise is a row vector, the elements correspond to the noise in the x, y, and z axes of the magnetometer, respectively.
- If MagnetometerBiasNoise is a scalar, the single element is applied to each axis.

State — State vector of extended Kalman filter

28-element column vector

State vector of the extended Kalman filter. The state values represent:

State	Units	Index
Orientation (quaternion parts)	N/A	1:4
Angular Velocity (XYZ)	rad/s	5:7

State	Units	Index
Position (NED or ENU)	m	8:10
Velocity (NED or ENU)	m/s	11:13
Acceleration (NED or ENU)	m/s ²	14:16
Accelerometer Bias (XYZ)	m/s ²	17:19
Gyroscope Bias (XYZ)	rad/s	20:22
Geomagnetic Field Vector (NED or ENU)	μT	23:25
Magnetometer Bias (XYZ)	μT	26:28

The default initial state corresponds to an object at rest located at $[0 \ 0 \ 0]$ in geodetic LLA coordinates.

Data Types: `single` | `double`

StateCovariance — State error covariance for extended Kalman filter

`eye(28)` (default) | 28-by-28 matrix

State error covariance for the extended Kalman filter, specified as a 28-by-28-element matrix of real numbers.

Data Types: `single` | `double`

Object Functions

<code>predict</code>	Update states based on motion model for <code>insfilterAsync</code>
<code>fuseaccel</code>	Correct states using accelerometer data for <code>insfilterAsync</code>
<code>fusegyro</code>	Correct states using gyroscope data for <code>insfilterAsync</code>
<code>fusemag</code>	Correct states using magnetometer data for <code>insfilterAsync</code>
<code>fusegps</code>	Correct states using GPS data for <code>insfilterAsync</code>
<code>correct</code>	Correct states using direct state measurements for <code>insfilterAsync</code>
<code>residual</code>	Residuals and residual covariances from direct state measurements for <code>insfilterAsync</code>
<code>residualaccel</code>	Residuals and residual covariance from accelerometer measurements for <code>insfilterAsync</code>
<code>residualgps</code>	Residuals and residual covariance from GPS measurements for <code>insfilterAsync</code>
<code>residualmag</code>	Residuals and residual covariance from magnetometer measurements for <code>insfilterAsync</code>
<code>residualgyro</code>	Residuals and residual covariance from gyroscope measurements for <code>insfilterAsync</code>
<code>pose</code>	Current position, orientation, and velocity estimate for <code>insfilterAsync</code>
<code>reset</code>	Reset internal states for <code>insfilterAsync</code>
<code>stateinfo</code>	Display state vector information for <code>insfilterAsync</code>
<code>copy</code>	Create copy of <code>insfilterAsync</code>
<code>tune</code>	Tune <code>insfilterAsync</code> parameters to reduce estimation error
<code>tunernoise</code>	Noise structure of fusion filter

Examples

Estimate Pose of UAV

Load logged sensor data and ground truth pose.

```
load('uavshort.mat','refloc','initstate','imuFs', ...
     'accel','gyro','mag','lla','gpsvel', ...
     'trueOrient','truePos')
```

Create an INS filter to fuse asynchronous MARG and GPS data to estimate pose.

```
filt = insfilterAsync;
filt.ReferenceLocation = refloc;
filt.State = [initstate(1:4);0;0;0;initstate(5:10);0;0;0;initstate(11:end)];
```

Define sensor measurement noises. The noises were determined from datasheets and experimentation.

```
Rmag = 80;
Rvel = 0.0464;
Racc = 800;
Rgyro = 1e-4;
Rpos = 34;
```

Preallocate variables for position and orientation. Allocate a variable for indexing into the GPS data.

```
N = size(accel,1);
p = zeros(N,3);
q = zeros(N,1,'quaternion');
```

```
gpsIdx = 1;
```

Fuse accelerometer, gyroscope, magnetometer, and GPS data. The outer loop predicts the filter forward one time step and fuses accelerometer and gyroscope data at the IMU sample rate.

```
for ii = 1:N

    % Predict the filter forward one time step
    predict(filt,1./imuFs);

    % Fuse accelerometer and gyroscope readings
    fuseaccel(filt,accel(ii,:),Racc);
    fusegyro(filt,gyro(ii,:),Rgyro);

    % Fuse magnetometer at 1/2 the IMU rate
    if ~mod(ii, fix(imuFs/2))
        fusemag(filt,mag(ii,:),Rmag);
    end

    % Fuse GPS once per second
    if ~mod(ii,imuFs)
        fusegps(filt,lla(gpsIdx,:),Rpos,gpsvel(gpsIdx,:),Rvel);
        gpsIdx = gpsIdx + 1;
    end

    % Log the current pose estimate
    [p(ii,:),q(ii)] = pose(filt);

end
```

Calculate the RMS errors between the known true position and orientation and the output from the asynchronous IMU filter.

```
posErr = truePos - p;
qErr = rad2deg(dist(trueOrient,q));

pRMS = sqrt(mean(posErr.^2));
qRMS = sqrt(mean(qErr.^2));

fprintf('Position RMS Error\n');
Position RMS Error
fprintf('\tX: %.2f, Y: %.2f, Z: %.2f (meters)\n\n',pRMS(1),pRMS(2),pRMS(3));
    X: 0.55, Y: 0.71, Z: 0.74 (meters)

fprintf('Quaternion Distance RMS Error\n');
Quaternion Distance RMS Error
fprintf('\t%.2f (degrees)\n\n', qRMS);
    4.72 (degrees)

Visualize the true position and the estimated position.

plot3(truePos(:,1),truePos(:,2),truePos(:,3),'LineWidth',2)
hold on
plot3(p(:,1),p(:,2),p(:,3),'r','LineWidth',2)
grid on
xlabel('N (m)')
ylabel('E (m)')
zlabel('D (m)')
```

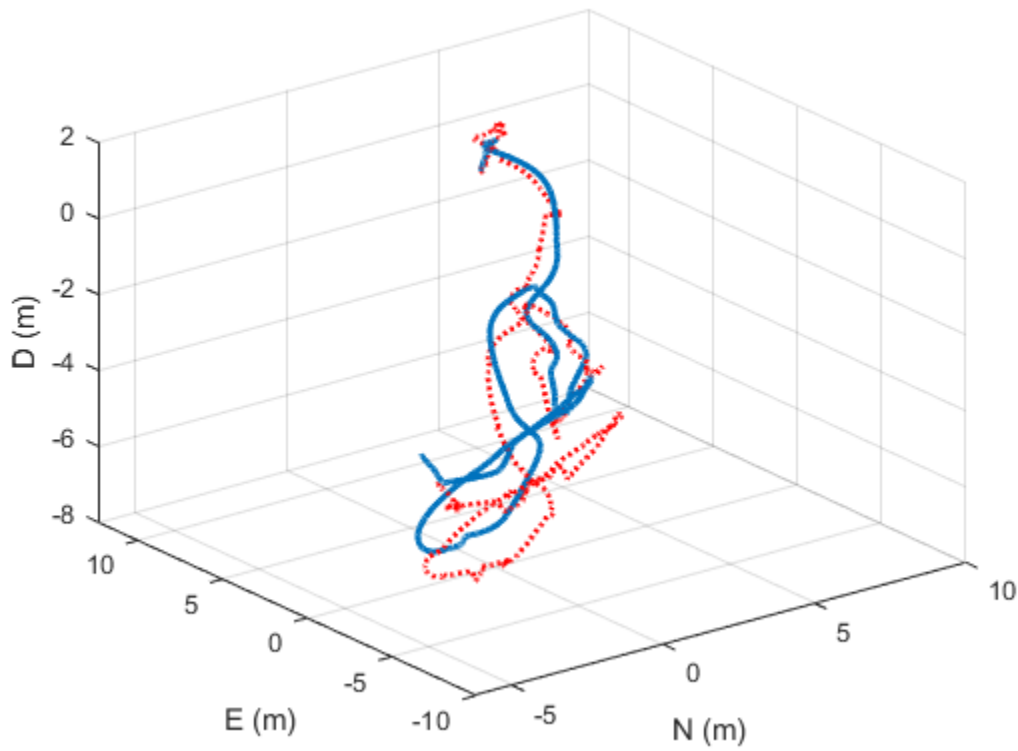

Algorithms

Dynamic Model Used in `insfilterAsync`

Note: The following algorithm only applies to an NED reference frame.

`insfilterAsync` implements a 28-axis continuous-discrete extended Kalman filter using sequential fusion. The filter relies on the assumption that individual sensor measurements are uncorrelated. The filter uses an omnidirectional motion model and assumes constant angular velocity and constant acceleration. The state is defined as:

$$x = \begin{bmatrix} q_0 \\ q_1 \\ q_2 \\ q_3 \\ \text{angVel}_x \\ \text{angVel}_y \\ \text{angVel}_z \\ \text{position}_N \\ \text{position}_E \\ \text{position}_D \\ \nu_N \\ \nu_E \\ \nu_D \\ \text{accel}_N \\ \text{accel}_E \\ \text{accel}_D \\ \text{accelbias}_x \\ \text{accelbias}_y \\ \text{accelbias}_z \\ \text{gyrobias}_x \\ \text{gyrobias}_y \\ \text{gyrobias}_z \\ \text{geomagneticFieldVector}_N \\ \text{geomagneticFieldVector}_E \\ \text{geomagneticFieldVector}_D \\ \text{magbias}_x \\ \text{magbias}_y \\ \text{magbias}_z \end{bmatrix}$$

where

- q_0, q_1, q_2, q_3 -- Parts of orientation quaternion. The orientation quaternion represents a frame rotation from the platform's current orientation to the local NED coordinate system.
- $\text{angVel}_x, \text{angVel}_y, \text{angVel}_z$ -- Angular velocity relative to the platform's body frame.
- $\text{position}_N, \text{position}_E, \text{position}_D$ -- Position of the platform in the local NED coordinate system.
- ν_N, ν_E, ν_D -- Velocity of the platform in the local NED coordinate system.
- $\text{accel}_N, \text{accel}_E, \text{accel}_D$ -- Acceleration of the platform in the local NED coordinate system.
- $\text{accelbias}_x, \text{accelbias}_y, \text{accelbias}_z$ -- Bias in the accelerometer reading.
- $\text{gyrobias}_x, \text{gyrobias}_y, \text{gyrobias}_z$ -- Bias in the gyroscope reading.

- *geomagneticFieldVector_N*, *geomagneticFieldVector_E*, *geomagneticFieldVector_D* -- Estimate of the geomagnetic field vector at the reference location.
- *magbias_x*, *magbias_y*, *magbias_z* -- Bias in the magnetometer readings.

Given the conventional formation of the process equation, $\dot{x} = f(x) + w$, w is the process noise, \dot{x} is the derivative of x , and:

$$f(x) = \begin{bmatrix} \frac{-(q_1)(angVel_X) - (q_2)(angVel_Y) - (q_3)(angVel_Z)}{2} \\ \frac{(q_0)(angVel_X) - (q_3)(angVel_Y) + (q_1)(angVel_Z)}{2} \\ \frac{(q_3)(angVel_X) + (q_0)(angVel_Y) - (q_1)(angVel_Z)}{2} \\ \frac{(q_1)(angVel_X) - (q_2)(angVel_Y) + (q_0)(angVel_Z)}{2} \\ 0 \\ 0 \\ 0 \\ \nu_N \\ \nu_E \\ \nu_D \\ accel_N \\ accel_E \\ accel_D \\ 0 \end{bmatrix}$$

Extended Capabilities

C/C++ Code Generation

Generate C and C++ code using MATLAB® Coder™.

See Also

`insfilterErrorState` | `insfilterMARG` | `insfilterNonholonomic`

Introduced in R2019a

copy

Create copy of `insfilterMARG`

Syntax

```
newFilter = copy(filter)
```

Description

`newFilter = copy(filter)` returns a copy of the `insfilterMARG`, `filter`, with the exactly same property values.

Input Arguments

filter — Filter to be copied

`insfilterMARG`

Filter to be copied, specified as an `insfilterMARG` object.

Output Arguments

newFilter — New copied filter

`insfilterMARG`

New copied filter, returned as an `insfilterMARG` object.

See Also

`insfilterMARG`

Introduced in R2020b

correct

Correct states using direct state measurements for `insfilterMARG`

Syntax

```
correct(FUSE, idx, measurement, measurementCovariance)
```

Description

`correct(FUSE, idx, measurement, measurementCovariance)` corrects the state and state estimation error covariance based on the measurement and measurement covariance. The measurement maps directly to the state specified by the indices `idx`.

Input Arguments

FUSE — `insfilterMARG` object

object

`insfilterMARG`, specified as an object.

idx — State vector Index of measurement to correct

N -element vector of increasing integers in the range [1,22]

State vector index of measurement to correct, specified as an N -element vector of increasing integers in the range [1, 22].

The state values represent:

State	Units	Index
Orientation (quaternion parts)		1:4
Position (NED)	m	5:7
Velocity (NED)	m/s	8:10
Delta Angle Bias (XYZ)	rad	11:13
Delta Velocity Bias (XYZ)	m/s	14:16
Geomagnetic Field Vector (NED)	μT	17:19
Magnetometer Bias (XYZ)	μT	20:22

Data Types: `single` | `double`

measurement — Direct measurement of state

N -element vector

Direct measurement of state, specified as a N -element vector. N is the number of elements of the index argument, `idx`.

Data Types: `single` | `double`

measurementCovariance — Covariance of measurementscalar | N -element vector | N -by- N matrix

Covariance of measurement, specified as a scalar, N -element vector, or N -by- N matrix. N is the number of elements of the index argument, `idx`.

Data Types: `single` | `double`**Extended Capabilities****C/C++ Code Generation**

Generate C and C++ code using MATLAB® Coder™.

See Also`insfilter` | `insfilterMARG`**Introduced in R2018b**

fusegps

Correct states using GPS data for `insfilterMARG`

Syntax

```
[res,resCov] = fusegps(FUSE,position,positionCovariance)
[res,resCov] = fusegps(FUSE,position,positionCovariance,velocity,
velocityCovariance)
```

Description

`[res,resCov] = fusegps(FUSE,position,positionCovariance)` fuses GPS position data to correct the state estimate.

`[res,resCov] = fusegps(FUSE,position,positionCovariance,velocity,velocityCovariance)` fuses GPS position and velocity data to correct the state estimate.

Input Arguments

FUSE — `insfilterMARG` object

object

`insfilterMARG`, specified as an object.

position — Position of GPS receiver (LLA)

3-element row vector

Position of GPS receiver in geodetic latitude, longitude, and altitude (LLA) specified as a real finite 3-element row vector. Latitude and longitude are in degrees with north and east being positive. Altitude is in meters.

Data Types: `single` | `double`

positionCovariance — Position measurement covariance of GPS receiver (m²)

3-by-3 matrix

Position measurement covariance of GPS receiver in m², specified as a 3-by-3 matrix.

Data Types: `single` | `double`

velocity — Velocity of GPS receiver in local NED coordinate system (m/s)

3-element row vector

Velocity of the GPS receiver in the local NED coordinate system in m/s, specified as a 3-element row vector.

Data Types: `single` | `double`

velocityCovariance — Velocity measurement covariance of GPS receiver (m/s²)

3-by-3 matrix

Velocity measurement covariance of the GPS receiver in the local NED coordinate system in m/s^2 , specified as a 3-by-3 matrix.

Data Types: `single` | `double`

Output Arguments

res — Position and velocity residual

1-by-6 vector of real values

Position and velocity residual, returned as a 1-by-6 vector of real values in m and m/s, respectively.

resCov — Residual covariance

6-by-6 matrix of real values

Residual covariance, returned as a 6-by-6 matrix of real values.

Extended Capabilities

C/C++ Code Generation

Generate C and C++ code using MATLAB® Coder™.

See Also

`insfilter` | `insfilterMARG`

Introduced in R2018b

fusemag

Correct states using magnetometer data for `insfilterMARG`

Syntax

```
[res, resCov] = fusemag(FUSE, magReadings, magReadingsCovariance)
```

Description

`[res, resCov] = fusemag(FUSE, magReadings, magReadingsCovariance)` fuses magnetometer data to correct the state estimate.

Input Arguments

FUSE — `insfilterMARG` object

object

`insfilterMARG`, specified as an object.

magReadings — Magnetometer readings (μT)

3-element row vector

Magnetometer readings in μT , specified as a 3-element row vector of finite real numbers.

Data Types: `single` | `double`

magReadingsCovariance — Magnetometer readings error covariance (μT^2)

scalar | 3-element row vector | 3-by-3 matrix

Magnetometer readings error covariance in μT^2 , specified as a scalar, 3-element row vector, or 3-by-3 matrix.

Data Types: `single` | `double`

Output Arguments

res — Residual

1-by-3 vector of real values

Residual, returned a 1-by-3 vector of real values in μT .

Data Types: `single` | `double`

resCov — Residual covariance

3-by-3 matrix of real values

Residual covariance, returned a 3-by-3 matrix of real values in $(\mu\text{T})^2$.

Extended Capabilities

C/C++ Code Generation

Generate C and C++ code using MATLAB® Coder™.

See Also

`insfilter` | `insfilterMARG`

Introduced in R2018b

residualmag

Residuals and residual covariance from magnetometer measurements for `insfilterMARG`

Syntax

```
[res,resCov] = residualmag(FUSE,magReadings,magReadingsCovariance)
```

Description

`[res,resCov] = residualmag(FUSE,magReadings,magReadingsCovariance)` computes the residual, `residual`, and the residual covariance, `resCov`, based on the magnetometer readings and the corresponding covariance.

Input Arguments

FUSE — `insfilterMARG` object

object

`insfilterMARG`, specified as an object.

magReadings — Magnetometer readings (μT)

3-element row vector

Magnetometer readings in μT , specified as a 3-element row vector of finite real numbers.

Data Types: `single` | `double`

magReadingsCovariance — Magnetometer readings error covariance (μT^2)

scalar | 3-element row vector | 3-by-3 matrix

Magnetometer readings error covariance in μT^2 , specified as a scalar, 3-element row vector, or 3-by-3 matrix.

Data Types: `single` | `double`

Output Arguments

res — Residual

1-by-3 vector of real values

Residual, returned as a 1-by-3 vector of real values in μT .

Data Types: `single` | `double`

resCov — Residual covariance

3-by-3 matrix of real values

Residual covariance, returned a 3-by-3 matrix of real values in $(\mu\text{T})^2$.

See Also

`insfilter` | `insfilterMARG`

Introduced in R2020a

pose

Current orientation and position estimate for `insfilterMARG`

Syntax

```
[position,orientation,velocity] = pose(FUSE)
[position,orientation,velocity] = pose(FUSE,format)
```

Description

`[position,orientation,velocity] = pose(FUSE)` returns the current estimate of the pose and velocity.

`[position,orientation,velocity] = pose(FUSE,format)` returns the current estimate of the pose with orientation in the specified orientation format.

Input Arguments

FUSE — `insfilterMARG` object

object

`insfilterMARG`, specified as an object.

format — Output orientation format

'quaternion' (default) | 'rotmat'

Output orientation format, specified as either 'quaternion' for a quaternion or 'rotmat' for a rotation matrix.

Data Types: char | string

Output Arguments

position — Position estimate in the local NED coordinate system (m)

3-element row vector

Position estimate in the local NED coordinate system in meters, returned as a 3-element row vector.

Data Types: single | double

orientation — Orientation estimate in the local NED coordinate system

quaternion (default) | 3-by-3 rotation matrix

Orientation estimate in the local NED coordinate system, specified as a scalar quaternion or 3-by-3 rotation matrix. The quaternion or rotation matrix represents a frame rotation from the local NED reference frame to the body reference frame.

Data Types: single | double | quaternion

velocity — Velocity estimate in the local NED coordinate system (m/s)

3-element row vector

Velocity estimate in the local NED coordinate system in m/s, returned as a 3-element row vector.

Data Types: `single` | `double`

Extended Capabilities

C/C++ Code Generation

Generate C and C++ code using MATLAB® Coder™.

See Also

`insfilter` | `insfilterMARG`

Introduced in R2018b

predict

Update states using accelerometer and gyroscope data for `insfilterMARG`

Syntax

```
predict(FUSE, accelReadings, gyroReadings)
```

Description

`predict(FUSE, accelReadings, gyroReadings)` fuses accelerometer and gyroscope data to update the state estimate.

Input Arguments

FUSE — `insfilterMARG` object

object

`insfilterMARG`, specified as an object.

accelReadings — Accelerometer readings in local sensor body coordinate system (m/s²)

3-element row vector

Accelerometer readings in m/s², specified as a 3-element row vector.

Data Types: `single` | `double`

gyroReadings — Gyroscope readings in local sensor body coordinate system (rad/s)

3-element row vector

Gyroscope readings in rad/s, specified as a 3-element row vector.

Data Types: `single` | `double`

Extended Capabilities

C/C++ Code Generation

Generate C and C++ code using MATLAB® Coder™.

See Also

`insfilter` | `insfilterMARG`

Introduced in R2018b

reset

Reset internal states for `insfilterMARG`

Syntax

`reset(FUSE)`

Description

`reset(FUSE)` resets the State, StateCovariance, and internal integrators to their default values.

Input Arguments

FUSE — `insfilterMARG` object

object

`insfilterMARG`, specified as an object.

Extended Capabilities

C/C++ Code Generation

Generate C and C++ code using MATLAB® Coder™.

See Also

`insfilter` | `insfilterMARG`

Introduced in R2018b

stateinfo

Display state vector information for `insfilterMARG`

Syntax

```
stateinfo(FUSE)
info = stateinfo(FUSE)
```

Description

`stateinfo(FUSE)` displays the meaning of each index of the State property and the associated units.

`info = stateinfo(FUSE)` returns a structure with fields containing descriptions of the elements of the state vector of the filter, FUSE.

Examples

State Information of `insfilterMARG`

Create an `insfilterMARG` object.

```
filter = insfilterMARG;
```

Display the state information of the created filter.

```
stateinfo(filter)

States                Units    Index
Orientation (quaternion parts)    1:4
Position (NAV)                   m       5:7
Velocity (NAV)                    m/s    8:10
Delta Angle Bias (XYZ)            rad    11:13
Delta Velocity Bias (XYZ)         m/s    14:16
Geomagnetic Field Vector (NAV)     $\mu$ T    17:19
Magnetometer Bias (XYZ)           $\mu$ T    20:22
```

Output the state information of the filter as a structure.

```
info = stateinfo(filter)

info = struct with fields:
    Orientation: [1 2 3 4]
    Position: [5 6 7]
    Velocity: [8 9 10]
    DeltaAngleBias: [11 12 13]
    DeltaVelocityBias: [14 15 16]
    GeomagneticFieldVector: [17 18 19]
    MagnetometerBias: [20 21 22]
```

Input Arguments

FUSE — `insfilterMARG` object

object

`insfilterMARG`, specified as an object.

info — State information

structure

State information, returned as a structure with fields containing descriptions of the elements of the state vector of the filter. The values of each field are the corresponding indices of the state vector.

Extended Capabilities

C/C++ Code Generation

Generate C and C++ code using MATLAB® Coder™.

See Also

`insfilter` | `insfilterMARG`

Introduced in R2018b

tune

Tune `insfilterMARG` parameters to reduce estimation error

Syntax

```
tunedMeasureNoise = tune(filter,measureNoise,sensorData,groundTruth)
tunedMeasureNoise = tune( ____,config)
```

Description

`tunedMeasureNoise = tune(filter,measureNoise,sensorData,groundTruth)` adjusts the properties of the `insfilterMARG` filter object, `filter`, and measurement noises to reduce the root-mean-squared (RMS) state estimation error between the fused sensor data and the ground truth. The function also returns the tuned measurement noise, `tunedMeasureNoise`. The function uses the property values in the filter and the measurement noise provided in the `measureNoise` structure as the initial estimate for the optimization algorithm.

`tunedMeasureNoise = tune(____,config)` specifies the tuning configuration based on a `tunerconfig` object, `config`.

Examples

Tune `insfilterMARG` to Optimize Pose Estimate

Load the recorded sensor data and ground truth data.

```
load('insfilterMARGTuneData.mat');
```

Create tables for the sensor data and the truth data.

```
sensorData = table(Accelerometer, Gyroscope, ...
    Magnetometer, GPSPosition, GPSVelocity);
groundTruth = table(Orientation, Position);
```

Create an `insfilterMARG` filter object that has a few noise properties.

```
filter = insfilterMARG('State',initialState,...
    'StateCovariance',initialStateCovariance,...
    'AccelerometerBiasNoise',1e-7,...
    'GyroscopeBiasNoise',1e-7,...
    'MagnetometerBiasNoise',1e-7,...
    'GeomagneticVectorNoise',1e-7);
```

Create a tuner configuration object for the filter. Set the maximum iterations to eight. Also, set the tunable parameters.

```
cfg = tunerconfig('insfilterMARG', 'MaxIterations', 8);
cfg.TunableParameters = setdiff(cfg.TunableParameters, ...
    {'GeomagneticFieldVector', 'AccelerometerBiasNoise', ...
    'GyroscopeBiasNoise', 'MagnetometerBiasNoise'});
```

Use the tuner noise function to obtain a set of initial sensor noises used in the filter.

```
measNoise = tunernoise('insfilterMARG')
```

```
measNoise = struct with fields:
```

```
  MagnetometerNoise: 1
  GPSPositionNoise: 1
  GPSVelocityNoise: 1
```

Tune the filter and obtain the tuned parameters.

```
tunedParams = tune(filter, measNoise, sensorData, ...
  groundTruth, cfg);
```

Iteration	Parameter	Metric
1	AccelerometerNoise	2.5701
1	GPSPositionNoise	2.5446
1	GPSVelocityNoise	2.5279
1	GeomagneticVectorNoise	2.5268
1	GyroscopeNoise	2.5268
1	MagnetometerNoise	2.5204
2	AccelerometerNoise	2.5203
2	GPSPositionNoise	2.4908
2	GPSVelocityNoise	2.4695
2	GeomagneticVectorNoise	2.4684
2	GyroscopeNoise	2.4684
2	MagnetometerNoise	2.4615
3	AccelerometerNoise	2.4615
3	GPSPositionNoise	2.4265
3	GPSVelocityNoise	2.4000
3	GeomagneticVectorNoise	2.3988
3	GyroscopeNoise	2.3988
3	MagnetometerNoise	2.3911
4	AccelerometerNoise	2.3911
4	GPSPositionNoise	2.3500
4	GPSVelocityNoise	2.3164
4	GeomagneticVectorNoise	2.3153
4	GyroscopeNoise	2.3153
4	MagnetometerNoise	2.3068
5	AccelerometerNoise	2.3068
5	GPSPositionNoise	2.2587
5	GPSVelocityNoise	2.2166
5	GeomagneticVectorNoise	2.2154
5	GyroscopeNoise	2.2154
5	MagnetometerNoise	2.2063
6	AccelerometerNoise	2.2063
6	GPSPositionNoise	2.1505
6	GPSVelocityNoise	2.0981
6	GeomagneticVectorNoise	2.0971
6	GyroscopeNoise	2.0971
6	MagnetometerNoise	2.0875
7	AccelerometerNoise	2.0874
7	GPSPositionNoise	2.0240
7	GPSVelocityNoise	1.9601
7	GeomagneticVectorNoise	1.9594
7	GyroscopeNoise	1.9594
7	MagnetometerNoise	1.9499

8	AccelerometerNoise	1.9499
8	GPSPositionNoise	1.8802
8	GPSVelocityNoise	1.8035
8	GeomagneticVectorNoise	1.8032
8	GyroscopeNoise	1.8032
8	MagnetometerNoise	1.7959

Fuse the sensor data using the tuned filter.

```

N = size(sensorData,1);
qEstTuned = quaternion.zeros(N,1);
posEstTuned = zeros(N,3);
for ii=1:N
    predict(filter,Accelerometer(ii,:),Gyroscope(ii,:));
    if all(~isnan(Magnetometer(ii,1)))
        fusemag(filter,Magnetometer(ii,:),...
            tunedParams.MagnetometerNoise);
    end
    if all(~isnan(GPSPosition(ii,1)))
        fusegps(filter,GPSPosition(ii,:),...
            tunedParams.GPSPositionNoise,GPSVelocity(ii,:),...
            tunedParams.GPSVelocityNoise);
    end
    [posEstTuned(ii,:),qEstTuned(ii,:)] = pose(filter);
end

```

Compute the RMS errors.

```

orientationErrorTuned = rad2deg(dist(qEstTuned,0Orientation));
rmsOrientationErrorTuned = sqrt(mean(orientationErrorTuned.^2))

rmsOrientationErrorTuned = 0.8580

positionErrorTuned = sqrt(sum((posEstTuned - Position).^2,2));
rmsPositionErrorTuned = sqrt(mean(positionErrorTuned.^2))

rmsPositionErrorTuned = 1.7946

```

Visualize the results.

```

figure();
t = (0:N-1)./filter.IMUSampleRate;
subplot(2,1,1)
plot(t,positionErrorTuned,'b');
title("Tuned insfilterMARG" + newline + ...
    "Euclidean Distance Position Error")
xlabel('Time (s)');
ylabel('Position Error (meters)')
subplot(2,1,2)
plot(t, orientationErrorTuned,'b');
title("Orientation Error")
xlabel('Time (s)');
ylabel('Orientation Error (degrees)');

```

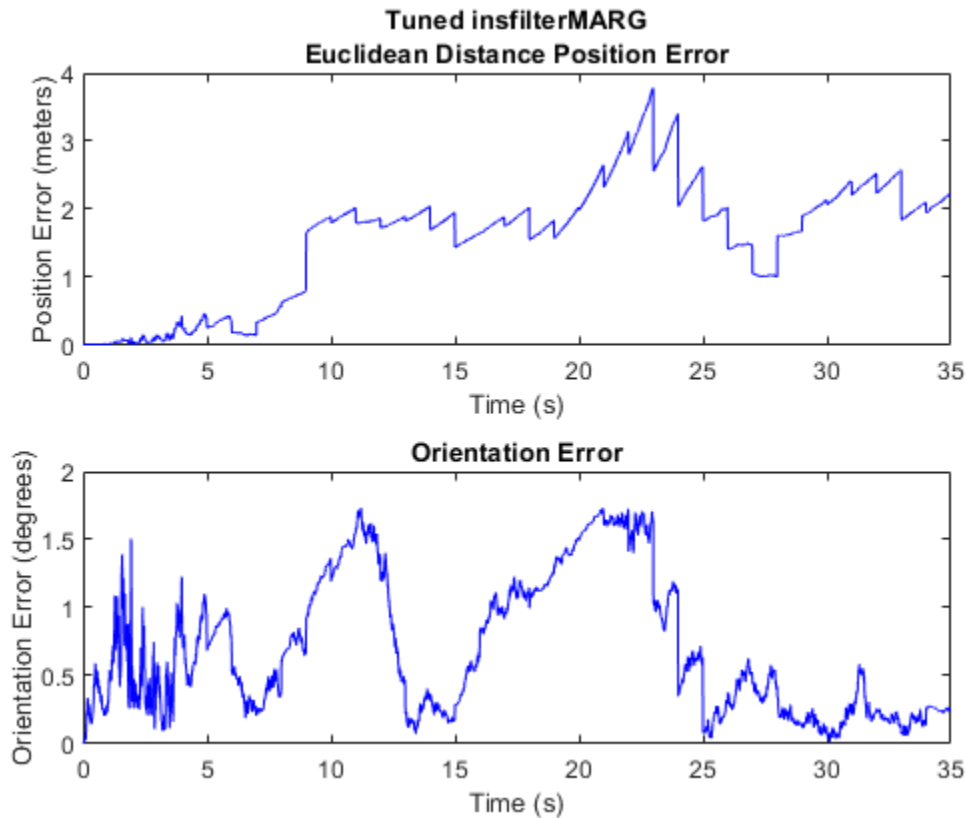

Input Arguments

filter – Filter object

`insfilterMARG` object

Filter object, specified as an `insfilterMARG` object.

measureNoise – Measurement noise

structure

Measurement noise, specified as a structure. The function uses the measurement noise input as the initial guess for tuning the measurement noise. The structure must contain these fields:

Field name	Description
<code>MagnetometerNoise</code>	Variance of magnetometer noise, specified as a scalar in $(\mu\text{T})^2$
<code>GPSPositionNoise</code>	Variance of GPS position noise, specified as a scalar in m^2
<code>GPSVelocityNoise</code>	Variance of GPS velocity noise, specified as a scalar in $(\text{m/s})^2$

sensorData – Sensor data

table

Sensor data, specified as a `table`. In each row, the sensor data is specified as:

- `Accelerometer` — Accelerometer data, specified as a 1-by-3 vector of scalars in m^2/s .
- `Gyroscope` — Gyroscope data, specified as a 1-by-3 vector of scalars in rad/s .
- `Magnetometer` — Magnetometer data, specified as a 1-by-3 vector of scalars in μT .
- `GPSPosition` — GPS position data, specified as a 1-by-3 vector of scalars in meters.
- `GPSVelocity` — GPS velocity data, specified as a 1-by-3 vector of scalars in m/s .

If the GPS sensor does not produce complete measurements, specify the corresponding entry for `GPSPosition` and/or `GPSVelocity` as `NaN`. If you set the `Cost` property of the tuner configuration input, `config`, to `Custom`, then you can use other data types for the `sensorData` input based on your choice.

groundTruth — Ground truth data

`table`

Ground truth data, specified as a `table`. In each row, the table can optionally contain any of these variables:

- `Orientation` — Orientation from the navigation frame to the body frame, specified as a quaternion or a 3-by-3 rotation matrix.
- `Position` — Position in navigation frame, specified as a 1-by-3 vector of scalars in meters.
- `Velocity` — Velocity in navigation frame, specified as a 1-by-3 vector of scalars in m/s .
- `DeltaAngleBias` — Delta angle bias, specified as a 1-by-3 vector of scalars in radians.
- `DeltaVelocityBias` — Delta velocity bias, specified as a 1-by-3 vector of scalars in m/s .
- `GeomagneticFieldVector` — Geomagnetic field vector in navigation frame, specified as a 1-by-3 vector of scalars.
- `MagnetometerBias` — Magnetometer bias in body frame, specified as a 1-by-3 vector of scalars in μT .

The function processes each row of the `sensorData` and `groundTruth` tables sequentially to calculate the state estimate and RMS error from the ground truth. State variables not present in `groundTruth` input are ignored for the comparison. The `sensorData` and the `groundTruth` tables must have the same number of rows.

If you set the `Cost` property of the tuner configuration input, `config`, to `Custom`, then you can use other data types for the `groundTruth` input based on your choice.

config — Tuner configuration

`tunerconfig` object

Tuner configuration, specified as a `tunerconfig` object.

Output Arguments

tunedMeasureNoise — Tuned measurement noise

`structure`

Tuned measurement noise, returned as a structure. The structure contains these fields.

Field name	Description
MagnetometerNoise	Variance of magnetometer noise, specified as a scalar in $(\mu\text{T})^2$
GPSPositionNoise	Variance of GPS position noise, specified as a scalar in m^2
GPSVelocityNoise	Variance of GPS velocity noise, specified as a scalar in $(\text{m/s})^2$

References

- [1] Abbeel, P., Coates, A., Montemerlo, M., Ng, A.Y. and Thrun, S. Discriminative Training of Kalman Filters. In *Robotics: Science and systems*, Vol. 2, pp. 1, 2005.

See Also

tunerconfig | tunernoise

Introduced in R2021a

residual

Residuals and residual covariances from direct state measurements for `insfilterMARG`

Syntax

```
[res, resCov]= residual(FUSE,idx,measurement,measurementCovariance)
```

Description

`[res, resCov]= residual(FUSE,idx,measurement,measurementCovariance)` computes the residual, `res`, and the residual covariance, `resCov`, based on the direct state measurement and measurement covariance. The measurement maps directly to the states specified by indices, `idx`.

Input Arguments

FUSE — `insfilterMARG` object

object

`insfilterMARG`, specified as an object.

idx — State vector index of measurement

N -element vector of increasing integers in the range [1,22]

State vector index of measurement, specified as an N -element vector of increasing integers in the range [1, 22].

The state values represent:

State	Units	Index
Orientation (quaternion parts)		1:4
Position (NED)	m	5:7
Velocity (NED)	m/s	8:10
Delta Angle Bias (XYZ)	rad	11:13
Delta Velocity Bias (XYZ)	m/s	14:16
Geomagnetic Field Vector (NED)	μT	17:19
Magnetometer Bias (XYZ)	μT	20:22

measurement — Direct measurement of state

N -element vector

Direct measurement of state, specified as a N -element vector. N is the number of elements of the index argument, `idx`.

measurementCovariance — Covariance of measurement

N -by- N matrix

Covariance of measurement, specified as an N -by- N matrix. N is the number of elements of the index argument, `idx`.

Output Arguments

res — Measurement residual

1-by- N vector of real values

Measurement residual, returned as a 1-by- N vector of real values.

resCov — Residual covariance

N -by- N matrix of real values

Residual covariance, returned as a N -by- N matrix of real values.

See Also

insfilterMARG

Introduced in R2020a

residualgps

Residuals and residual covariance from GPS measurements for `insfilterMARG`

Syntax

```
[res,resCov] = residualgps(FUSE,position,positionCovariance)
[res,resCov] = residualgps(FUSE,position,positionCovariance,velocity,
velocityCovariance)
```

Description

`[res,resCov] = residualgps(FUSE,position,positionCovariance)` computes the residual, `res`, and the residual covariance, `resCov`, based on the GPS position measurement and covariance.

`[res,resCov] = residualgps(FUSE,position,positionCovariance,velocity,velocityCovariance)` computes the residual, `res`, and the residual covariance, `resCov`, based on the GPS position measurement and covariance.

Input Arguments

FUSE — `insfilterMARG` object

object

`insfilterMARG`, specified as an object.

position — Position of GPS receiver (LLA)

3-element row vector

Position of GPS receiver in geodetic latitude, longitude, and altitude (LLA) specified as a real finite 3-element row vector. Latitude and longitude are in degrees with north and east being positive. Altitude is in meters.

Data Types: `single` | `double`

positionCovariance — Position measurement covariance of GPS receiver (m²)

3-by-3 matrix

Position measurement covariance of GPS receiver in m², specified as a 3-by-3 matrix.

Data Types: `single` | `double`

velocity — Velocity of GPS receiver in local NED coordinate system (m/s)

3-element row vector

Velocity of the GPS receiver in the local NED coordinate system in m/s, specified as a 3-element row vector.

Data Types: `single` | `double`

velocityCovariance — Velocity measurement covariance of GPS receiver (m/s²)

3-by-3 matrix

Velocity measurement covariance of the GPS receiver in the local NED coordinate system in m/s^2 , specified as a 3-by-3 matrix.

Data Types: `single` | `double`

Output Arguments

res — Position and velocity residual

1-by-3 vector of real values | 1-by-6 vector of real values

Position and velocity residual, returned as a 1-by-3 vector of real values if the inputs only contain position information, and returned as 1-by-6 vector of real values if the inputs also contain velocity information.

resCov — Residual covariance

3-by-3 matrix of real values | 6-by-6 matrix of real values

Residual covariance, returned as a 3-by-3 matrix of real values if the inputs only contain position information, and a 6-by-6 matrix of real values if the inputs also contain velocity information.

See Also

`insfilter` | `insfilterMARG`

Introduced in R2020a

insfilterMARG

Estimate pose from MARG and GPS data

Description

The `insfilterMARG` object implements sensor fusion of MARG and GPS data to estimate pose in the NED (or ENU) reference frame. MARG (magnetic, angular rate, gravity) data is typically derived from magnetometer, gyroscope, and accelerometer sensors. The filter uses a 22-element state vector to track the orientation quaternion, velocity, position, MARG sensor biases, and geomagnetic vector. The `insfilterMARG` object uses an extended Kalman filter to estimate these quantities.

Creation

Syntax

```
filter = insfilterMARG
filter = insfilterMARG('ReferenceFrame',RF)
filter = insfilterMARG(___,Name,Value)
```

Description

`filter = insfilterMARG` creates an `insfilterMARG` object with default property values.

`filter = insfilterMARG('ReferenceFrame',RF)` allows you to specify the reference frame, RF, of the filter. Specify RF as 'NED' (North-East-Down) or 'ENU' (East-North-Up). The default value is 'NED'.

`filter = insfilterMARG(___,Name,Value)` also allows you set properties of the created filter using one or more name-value pairs. Enclose each property name in single quotes.

Properties

IMUSampleRate — Sample rate of the IMU (Hz)

100 (default) | positive scalar

Sample rate of the inertial measurement unit (IMU) in Hz, specified as a positive scalar.

Data Types: `single` | `double`

ReferenceLocation — Reference location (deg, deg, meters)

[0 0 0] (default) | 3-element positive row vector

Reference location, specified as a 3-element row vector in geodetic coordinates (latitude, longitude, and altitude). Altitude is the height above the reference ellipsoid model, WGS84. The reference location units are [degrees degrees meters].

Data Types: `single` | `double`

GyroscopeNoise — Multiplicative process noise variance from gyroscope (rad/s)²

1e-9 (default) | scalar | 3-element row vector

Multiplicative process noise variance from the gyroscope in (rad/s)², specified as a scalar or 3-element row vector of positive real finite numbers.

- If **GyroscopeNoise** is specified as a row vector, the elements correspond to the noise in the *x*, *y*, and *z* axes of the gyroscope, respectively.
- If **GyroscopeNoise** is specified as a scalar, the single element is applied to the *x*, *y*, and *z* axes of the gyroscope.

Data Types: single | double

GyroscopeBiasNoise — Multiplicative process noise variance from gyroscope bias (rad/s)²

1e-10 (default) | positive scalar | 3-element row vector

Multiplicative process noise variance from the gyroscope bias in (rad/s)², specified as a scalar or 3-element row vector of positive real numbers.

- If **GyroscopeBiasNoise** is specified as a row vector, the elements correspond to the noise in the *x*, *y*, and *z* axes of the gyroscope bias, respectively.
- If **GyroscopeBiasNoise** is specified as a scalar, the single element is applied to each axis.

Data Types: single | double

AccelerometerNoise — Multiplicative process noise variance from accelerometer (m/s²)²

1e-4 (default) | scalar | 3-element row vector

Multiplicative process noise variance from the accelerometer in (m/s²)², specified as a scalar or 3-element row vector of positive real finite numbers.

- If **AccelerometerNoise** is specified as a row vector, the elements correspond to the noise in the *x*, *y*, and *z* axes of the accelerometer, respectively.
- If **AccelerometerNoise** is specified as a scalar, the single element is applied to each axis.

Data Types: single | double

AccelerometerBiasNoise — Multiplicative process noise variance from accelerometer bias (m/s²)²

1e-4 (default) | positive scalar | 3-element row vector

Multiplicative process noise variance from the accelerometer bias in (m/s²)², specified as a scalar or 3-element row vector of positive real numbers.

- If **AccelerometerBiasNoise** is specified as a row vector, the elements correspond to the noise in the *x*, *y*, and *z* axes of the accelerometer bias, respectively.
- If **AccelerometerBiasNoise** is specified as a scalar, the single element is applied to each axis.

Data Types: single | double

GeomagneticVectorNoise — Additive process noise for geomagnetic vector (μT²)

1e-6 (default) | positive scalar | 3-element row vector

Additive process noise for geomagnetic vector in μT², specified as a scalar or 3-element row vector of positive real numbers.

- If `GeomagneticVectorNoise` is specified as a row vector, the elements correspond to the noise in the x , y , and z axes of the geomagnetic vector, respectively.
- If `GeomagneticVectorNoise` is specified as a scalar, the single element is applied to each axis.

Data Types: `single` | `double`

MagnetometerBiasNoise — Additive process noise for magnetometer bias (μT^2)

0.1 (default) | positive scalar | 3-element row vector

Additive process noise for magnetometer bias in μT^2 , specified as a scalar or 3-element row vector.

- If `MagnetometerBiasNoise` is specified as a row vector, the elements correspond to the noise in the x , y , and z axes of the magnetometer bias, respectively.
- If `MagnetometerBiasNoise` is specified as a scalar, the single element is applied to each axis.

Data Types: `single` | `double`

State — State vector of extended Kalman filter

22-element column vector

State vector of the extended Kalman filter. The state values represent:

State	Units	Index
Orientation (quaternion parts)	N/A	1:4
Position (NED or ENU)	m	5:7
Velocity (NED or ENU)	m/s	8:10
Delta Angle Bias (XYZ)	rad	11:13
Delta Velocity Bias (XYZ)	m/s	14:16
Geomagnetic Field Vector (NED or ENU)	μT	17:19
Magnetometer Bias (XYZ)	μT	20:22

Data Types: `single` | `double`

StateCovariance — State error covariance for extended Kalman filter

`eye(22)*1e-6` (default) | 22-by-22 matrix

State error covariance for the extended Kalman filter, specified as a 22-by-22-element matrix, or real numbers.

Data Types: `single` | `double`

Object Functions

<code>correct</code>	Correct states using direct state measurements for insfilterMARG
<code>residual</code>	Residuals and residual covariances from direct state measurements for insfilterMARG
<code>fusegps</code>	Correct states using GPS data for insfilterMARG
<code>residualgps</code>	Residuals and residual covariance from GPS measurements for insfilterMARG
<code>fusemag</code>	Correct states using magnetometer data for insfilterMARG
<code>residualmag</code>	Residuals and residual covariance from magnetometer measurements for insfilterMARG
<code>pose</code>	Current orientation and position estimate for insfilterMARG

predict	Update states using accelerometer and gyroscope data for insfilterMARG
reset	Reset internal states for insfilterMARG
stateinfo	Display state vector information for insfilterMARG
tune	Tune insfilterMARG parameters to reduce estimation error
copy	Create copy of insfilterMARG

Examples

Estimate Pose of UAV

This example shows how to estimate the pose of an unmanned aerial vehicle (UAV) from logged sensor data and ground truth pose.

Load the logged sensor data and ground truth pose of an UAV.

```
load uavshort.mat
```

Initialize the insfilterMARG filter object.

```
f = insfilterMARG;
f.IMUSampleRate = imuFs;
f.ReferenceLocation = refloc;
f.AccelerometerBiasNoise = 2e-4;
f.AccelerometerNoise = 2;
f.GyroscopeBiasNoise = 1e-16;
f.GyroscopeNoise = 1e-5;
f.MagnetometerBiasNoise = 1e-10;
f.GeoMagneticVectorNoise = 1e-12;
f.StateCovariance = 1e-9*ones(22);
f.State = initState;
```

```
gpsidx = 1;
N = size(accel,1);
p = zeros(N,3);
q = zeros(N,1,'quaternion');
```

Fuse accelerometer, gyroscope, magnetometer, and GPS data.

```
for ii = 1:size(accel,1) % Fuse IMU
    f.predict(accel(ii,:), gyro(ii,:));

    if ~mod(ii,fix(imuFs/2)) % Fuse magnetometer at 1/2 the IMU rate
        f.fusemag(mag(ii,:),Rmag);
    end

    if ~mod(ii,imuFs) % Fuse GPS once per second
        f.fusegps(lla(gpsidx,:),Rpos,gpsvel(gpsidx,:),Rvel);
        gpsidx = gpsidx + 1;
    end

    [p(ii,:),q(ii)] = pose(f); %Log estimated pose
end
```

Calculate and display RMS errors.

```
posErr = truePos - p;
qErr = rad2deg(dist(trueOrient,q));
```

```
pRMS = sqrt(mean(posErr.^2));
qRMS = sqrt(mean(qErr.^2));
fprintf('Position RMS Error\n\tX: %.2f, Y: %.2f, Z: %.2f (meters)\n\n',pRMS(1),pRMS(2),pRMS(3));
```

```
Position RMS Error
  X: 0.57, Y: 0.53, Z: 0.68 (meters)
```

```
fprintf('Quaternion Distance RMS Error\n\t%.2f (degrees)\n\n',qRMS);
```

```
Quaternion Distance RMS Error
  0.28 (degrees)
```

Algorithms

Note: The following algorithm only applies to an NED reference frame.

insfilterMARG uses a 22-axis extended Kalman filter structure to estimate pose in the NED reference frame. The state is defined as:

$$x = \begin{bmatrix} q_0 \\ q_1 \\ q_2 \\ q_3 \\ position_N \\ position_E \\ position_D \\ v_N \\ v_E \\ v_D \\ \Delta\theta_{bias_X} \\ \Delta\theta_{bias_Y} \\ \Delta\theta_{bias_Z} \\ \Delta v_{bias_X} \\ \Delta v_{bias_Y} \\ \Delta v_{bias_Z} \\ geomagneticFieldVector_N \\ geomagneticFieldVector_E \\ geomagneticFieldVector_D \\ mag_{bias_X} \\ mag_{bias_Y} \\ mag_{bias_Z} \end{bmatrix}$$

where

- q_0, q_1, q_2, q_3 -- Parts of orientation quaternion. The orientation quaternion represents a frame rotation from the platform's current orientation to the local NED coordinate system.
- $position_N, position_E, position_D$ -- Position of the platform in the local NED coordinate system.
- v_N, v_E, v_D -- Velocity of the platform in the local NED coordinate system.
- $\Delta\theta_{bias_X}, \Delta\theta_{bias_Y}, \Delta\theta_{bias_Z}$ -- Bias in the integrated gyroscope reading.
- $\Delta v_{bias_X}, \Delta v_{bias_Y}, \Delta v_{bias_Z}$ -- Bias in the integrated accelerometer reading.
- $geomagneticFieldVector_N, geomagneticFieldVector_E, geomagneticFieldVector_D$ -- Estimate of the geomagnetic field vector at the reference location.
- $magbias_X, magbias_Y, magbias_Z$ -- Bias in the magnetometer readings.

Given the conventional formation of the predicted state estimate,

$$x_{k|k-1} = f(\hat{x}_{k-1|k-1}, u_k)$$

u_k is controlled by accelerometer and gyroscope data that has been converted to delta velocity and delta angle through trapezoidal integration. The predicted state estimation is:

$x_{k|k-1} =$

$$\begin{aligned}
 & q_0 - q_1 \left(\frac{\Delta\theta_X - \Delta\theta_{biasX}}{2} \right) - q_2 \left(\frac{\Delta\theta_Y - \Delta\theta_{biasY}}{2} \right) - q_3 \left(\frac{\Delta\theta_Z - \Delta\theta_{biasZ}}{2} \right) \\
 & q_1 + q_0 \left(\frac{\Delta\theta_X - \Delta\theta_{biasX}}{2} \right) - q_3 \left(\frac{\Delta\theta_Y - \Delta\theta_{biasY}}{2} \right) + q_2 \left(\frac{\Delta\theta_Z - \Delta\theta_{biasZ}}{2} \right) \\
 & q_2 + q_3 \left(\frac{\Delta\theta_X - \Delta\theta_{biasX}}{2} \right) + q_0 \left(\frac{\Delta\theta_Y - \Delta\theta_{biasY}}{2} \right) - q_1 \left(\frac{\Delta\theta_Z - \Delta\theta_{biasZ}}{2} \right) \\
 & q_3 - q_2 \left(\frac{\Delta\theta_X - \Delta\theta_{biasX}}{2} \right) + q_1 \left(\frac{\Delta\theta_Y - \Delta\theta_{biasY}}{2} \right) + q_0 \left(\frac{\Delta\theta_Z - \Delta\theta_{biasZ}}{2} \right)
 \end{aligned}$$

 $position_N + (\Delta t)(v_N)$
 $position_E + (\Delta t)(v_E)$
 $position_D + (\Delta t)(v_D)$

$$\begin{aligned}
 & v_N + (\Delta t)(g_N) + (\Delta v_X - \Delta v_{biasX})(q_0^2 + q_1^2 - q_2^2 - q_3^2) - 2(\Delta v_Y - \Delta v_{biasY})(q_0 q_3 - q_1 q_2) + 2(\Delta v_Z - \Delta v_{biasZ})(q_0 q_2 + \\
 & v_E + (\Delta t)(g_E) + (\Delta v_Y - \Delta v_{biasY})(q_0^2 - q_1^2 + q_2^2 - q_3^2) + 2(\Delta v_X - \Delta v_{biasX})(q_0 q_3 + q_1 q_2) - 2(\Delta v_Z - \Delta v_{biasZ})(q_0 q_1 - \\
 & v_D + (\Delta t)(g_D) + (\Delta v_Z - \Delta v_{biasZ})(q_0^2 - q_1^2 - q_2^2 + q_3^2) - 2(\Delta v_X - \Delta v_{biasX})(q_0 q_2 - q_1 q_3) + 2(\Delta v_Y - \Delta v_{biasY})(q_0 q_1 +
 \end{aligned}$$

 $\Delta\theta_{biasX}$
 $\Delta\theta_{biasY}$

where

- $\Delta\theta_X, \Delta\theta_Y, \Delta\theta_Z$ -- Integrated gyroscope reading.
- $\Delta\nu_X, \Delta\nu_Y, \Delta\nu_Z$ -- Integrated accelerometer readings.
- Δt -- IMU sample time.
- g_N, g_E, g_D -- Constant gravity vector in the NED frame.

Extended Capabilities

C/C++ Code Generation

Generate C and C++ code using MATLAB® Coder™.

See Also

`insfilterAsync` | `insfilterErrorState` | `insfilterNonholonomic`

Topics

“Estimate Position and Orientation of a Ground Vehicle”

Introduced in R2018b

copy

Create copy of `insfilterNonholonomic`

Syntax

```
newFilter = copy(filter)
```

Description

`newFilter = copy(filter)` returns a copy of the `insfilterNonholonomic`, `filter`, with the exactly same property values.

Input Arguments

filter — Filter to be copied

`insfilterNonholonomic`

Filter to be copied, specified as an `insfilterNonholonomic` object.

Output Arguments

newFilter — New copied filter

`insfilterNonholonomic`

New copied filter, returned as an `insfilterNonholonomic` object.

See Also

`insfilterNonholonomic`

Introduced in R2020b

correct

Correct states using direct state measurements for `insfilterNonholonomic`

Syntax

```
correct(FUSE, idx, measurement, measurementCovariance)
```

Description

`correct(FUSE, idx, measurement, measurementCovariance)` corrects the state and state estimation error covariance based on the measurement and measurement covariance. The measurement maps directly to the state specified by the indices `idx`.

Input Arguments

FUSE — `insfilterNonholonomic` object
object

`insfilterNonholonomic`, specified as an object.

idx — **State vector Index of measurement to correct**
N-element vector of increasing integers in the range [1,16]

State vector index of measurement to correct, specified as an *N*-element vector of increasing integers in the range [1,16].

The state values represent:

State	Units	Index
Orientation (quaternion parts)		1:4
Gyroscope bias (XYZ)	rad/s	5:7
Position (NED)	m	8:10
Velocity (NED)	m/s	11:13
Accelerometer Bias (XYZ)	m/s ²	14:16

Data Types: `single` | `double`

measurement — **Direct measurement of state**
N-element vector

Direct measurement of state, specified as a *N*-element vector. *N* is the number of elements of the index argument, `idx`.

Data Types: `single` | `double`

measurementCovariance — **Covariance of measurement**
scalar | *N*-element vector | *N*-by-*N* matrix

Covariance of measurement, specified as a scalar, N -element vector, or N -by- N matrix. N is the number of elements of the index argument, `idx`.

Data Types: `single` | `double`

Extended Capabilities

C/C++ Code Generation

Generate C and C++ code using MATLAB® Coder™.

See Also

`insfilter` | `insfilterNonholonomic`

Introduced in R2018b

fusegps

Correct states using GPS data for `insfilterNonholonomic`

Syntax

```
[res,resCov] = fusegps(FUSE,position,positionCovariance)
[res,resCov] = fusegps(FUSE,position,positionCovariance,velocity,
velocityCovariance)
```

Description

`[res,resCov] = fusegps(FUSE,position,positionCovariance)` fuses GPS position data to correct the state estimate.

`[res,resCov] = fusegps(FUSE,position,positionCovariance,velocity,velocityCovariance)` fuses GPS position and velocity data to correct the state estimate.

Input Arguments

FUSE — `insfilterNonholonomic` object

object

`insfilterNonholonomic`, specified as an object.

position — Position of GPS receiver (LLA)

3-element row vector

Position of GPS receiver in geodetic latitude, longitude, and altitude (LLA) specified as a real finite 3-element row vector. Latitude and longitude are in degrees with north and east being positive. Altitude is in meters.

Data Types: `single` | `double`

positionCovariance — Position measurement covariance of GPS receiver (m²)

3-by-3 matrix

Position measurement covariance of GPS receiver in m², specified as a 3-by-3 matrix.

Data Types: `single` | `double`

velocity — Velocity of GPS receiver in local NED coordinate system (m/s)

3-element row vector

Velocity of the GPS receiver in the local NED coordinate system in m/s, specified as a 3-element row vector.

Data Types: `single` | `double`

velocityCovariance — Velocity measurement covariance of GPS receiver (m/s²)

3-by-3 matrix

Velocity measurement covariance of the GPS receiver in the local NED coordinate system in m/s^2 , specified as a 3-by-3 matrix.

Data Types: `single` | `double`

Output Arguments

res — Position and course residual

1-by-4 vector of real values

Position and course residual, returned as a 1-by-6 vector of real values in m and rad/s, respectively.

resCov — Residual covariance

4-by-4 matrix of real values

Residual covariance, returned as a 4-by-4 matrix of real values.

Extended Capabilities

C/C++ Code Generation

Generate C and C++ code using MATLAB® Coder™.

See Also

`insfilter` | `insfilterNonholonomic`

Introduced in R2018b

residual

Residuals and residual covariances from direct state measurements for `insfilterNonholonomic`

Syntax

```
[res, resCov]= residual(FUSE,idx,measurement,measurementCovariance)
```

Description

`[res, resCov]= residual(FUSE,idx,measurement,measurementCovariance)` computes the residual, `res`, and the residual covariance, `resCov`, based on the direct state measurement and measurement covariance. The measurement maps directly to the states specified by indices, `idx`.

Input Arguments

FUSE — `insfilterNonholonomic` object

object

`insfilterNonholonomic`, specified as an object.

idx — State vector Index of measurement to correct

N -element vector of increasing integers in the range [1,16]

State vector index of measurement to correct, specified as an N -element vector of increasing integers in the range [1,16].

The state values represent:

State	Units	Index
Orientation (quaternion parts)		1:4
Gyroscope bias (XYZ)	rad/s	5:7
Position (NED)	m	8:10
Velocity (NED)	m/s	11:13
Accelerometer Bias (XYZ)	m/s ²	14:16

Data Types: `single` | `double`

measurement — Direct measurement of state

N -element vector

Direct measurement of state, specified as a N -element vector. N is the number of elements of the index argument, `idx`.

measurementCovariance — Covariance of measurement

N -by- N matrix

Covariance of measurement, specified as an N -by- N matrix. N is the number of elements of the index argument, `idx`.

Output Arguments

res — Measurement residual

1-by- N vector of real values

Measurement residual, returned as a 1-by- N vector of real values.

resCov — Residual covariance

N -by- N matrix of real values

Residual covariance, returned as a N -by- N matrix of real values.

Extended Capabilities

C/C++ Code Generation

Generate C and C++ code using MATLAB® Coder™.

See Also

`insfilter` | `insfilterNonholonomic`

Introduced in R2020a

residualgps

Residuals and residual covariance from GPS measurements for `insfilterNonholonomic`

Syntax

```
[res,resCov] = residualgps(FUSE,position,positionCovariance)
[res,resCov] = residualgps(FUSE,position,positionCovariance,velocity,
velocityCovariance)
```

Description

`[res,resCov] = residualgps(FUSE,position,positionCovariance)` computes the residual, `res`, and the residual covariance, `resCov`, based on the GPS position measurement and covariance.

`[res,resCov] = residualgps(FUSE,position,positionCovariance,velocity,velocityCovariance)` computes the residual, `res`, and the residual covariance, `resCov`, based on the GPS position measurement and covariance.

Input Arguments

FUSE — `insfilterNonholonomic` object

object

`insfilterNonholonomic`, specified as an object.

position — Position of GPS receiver (LLA)

3-element row vector

Position of GPS receiver in geodetic latitude, longitude, and altitude (LLA) specified as a real finite 3-element row vector. Latitude and longitude are in degrees with north and east being positive. Altitude is in meters.

Data Types: `single` | `double`

positionCovariance — Position measurement covariance of GPS receiver (m²)

3-by-3 matrix

Position measurement covariance of GPS receiver in m², specified as a 3-by-3 matrix.

Data Types: `single` | `double`

velocity — Velocity of GPS receiver in local NED coordinate system (m/s)

3-element row vector

Velocity of the GPS receiver in the local NED coordinate system in m/s, specified as a 3-element row vector.

Data Types: `single` | `double`

velocityCovariance — Velocity measurement covariance of GPS receiver (m/s²)

3-by-3 matrix

Velocity measurement covariance of the GPS receiver in the local NED coordinate system in m/s^2 , specified as a 3-by-3 matrix.

Data Types: `single` | `double`

Output Arguments

res — Position and course residual

1-by-3 vector of real values | 1-by-4 vector of real values

Position and course residual, returned as a 1-by-3 vector of real values if the inputs only contain position information, and returned as a 1-by-4 vector of real values if the inputs also contain velocity information.

resCov — Residual covariance

3-by-3 matrix of real values | 4-by-4 matrix of real values

Residual covariance, returned as a 3-by-3 matrix of real values if the inputs only contain position information, and a 4-by-4 matrix of real values if the inputs also contain velocity information.

Extended Capabilities

C/C++ Code Generation

Generate C and C++ code using MATLAB® Coder™.

See Also

`insfilterNonholonomic`

Introduced in R2020a

tune

Tune `insfilterNonholonomic` parameters to reduce estimation error

Syntax

```
tunedMeasureNoise = tune(filter,measureNoise,sensorData,groundTruth)
tunedMeasureNoise = tune(___,config)
```

Description

`tunedMeasureNoise = tune(filter,measureNoise,sensorData,groundTruth)` adjusts the properties of the `insfilterNonholonomic` filter object, `filter`, and measurement noises to reduce the root-mean-squared (RMS) state estimation error between the fused sensor data and the ground truth. The function also returns the tuned measurement noise, `tunedMeasureNoise`. The function uses the property values in the filter and the measurement noise provided in the `measureNoise` structure as the initial estimate for the optimization algorithm.

`tunedMeasureNoise = tune(___,config)` specifies the tuning configuration based on a `tunerconfig` object, `config`.

Examples

Tune `insfilterNonholonomic` to Optimize Pose Estimate

Load the recorded sensor data and ground truth data.

```
load('insfilterNonholonomicTuneData.mat');
```

Create tables for the sensor data and the truth data.

```
sensorData = table(Accelerometer, Gyroscope, ...
    GPSPosition, GPSVelocity);
groundTruth = table(Orientation, Position);
```

Create an `insfilterNonholonomic` filter object.

```
filter = insfilterNonholonomic('State', initialState, ...
    'StateCovariance', initialStateCovariance, ...
    'DecimationFactor', 1);
```

Create a tuner configuration object for the filter. Set the maximum number of iterations to 30.

```
config = tunerconfig('insfilterNonholonomic','MaxIterations',30);
```

Use the `tunernoise` function to obtain a set of initial sensor noises used in the filter.

```
measNoise = tunernoise('insfilterNonholonomic')
```

```
measNoise = struct with fields:
    GPSPositionNoise: 1
```

GPSVelocityNoise: 1

Tune the filter and obtain the tuned measurement noise.

```
tunedNoise = tune(filter, measNoise, sensorData, groundTruth, config);
```

Iteration	Parameter	Metric
1	GyroscopeNoise	3.4877
1	AccelerometerNoise	3.3961
1	GyroscopeBiasNoise	3.3961
1	GyroscopeBiasDecayFactor	3.3961
1	AccelerometerBiasNoise	3.3961
1	AccelerometerBiasDecayFactor	3.3961
1	ZeroVelocityConstraintNoise	3.3935
1	GPSPositionNoise	3.2848
1	GPSVelocityNoise	3.2798
2	GyroscopeNoise	3.2641
2	AccelerometerNoise	3.1715
2	GyroscopeBiasNoise	3.1715
2	GyroscopeBiasDecayFactor	2.9661
2	AccelerometerBiasNoise	2.9661
2	AccelerometerBiasDecayFactor	2.9661
2	ZeroVelocityConstraintNoise	2.9617
2	GPSPositionNoise	2.8438
2	GPSVelocityNoise	2.8384
3	GyroscopeNoise	2.8373
3	AccelerometerNoise	2.7382
3	GyroscopeBiasNoise	2.7382
3	GyroscopeBiasDecayFactor	2.7382
3	AccelerometerBiasNoise	2.7382
3	AccelerometerBiasDecayFactor	2.7382
3	ZeroVelocityConstraintNoise	2.7335
3	GPSPositionNoise	2.6105
3	GPSVelocityNoise	2.6045
4	GyroscopeNoise	2.6023
4	AccelerometerNoise	2.5001
4	GyroscopeBiasNoise	2.5001
4	GyroscopeBiasDecayFactor	2.5001
4	AccelerometerBiasNoise	2.5001
4	AccelerometerBiasDecayFactor	2.5001
4	ZeroVelocityConstraintNoise	2.4953
4	GPSPositionNoise	2.3692
4	GPSVelocityNoise	2.3626
5	GyroscopeNoise	2.3595
5	AccelerometerNoise	2.2561
5	GyroscopeBiasNoise	2.2561
5	GyroscopeBiasDecayFactor	2.2508
5	AccelerometerBiasNoise	2.2508
5	AccelerometerBiasDecayFactor	2.2508
5	ZeroVelocityConstraintNoise	2.2469
5	GPSPositionNoise	2.1265
5	GPSVelocityNoise	2.1191
6	GyroscopeNoise	2.1148
6	AccelerometerNoise	2.0150
6	GyroscopeBiasNoise	2.0150
6	GyroscopeBiasDecayFactor	2.0150

6	AccelerometerBiasNoise	2.0150
6	AccelerometerBiasDecayFactor	2.0150
6	ZeroVelocityConstraintNoise	2.0116
6	GPSPositionNoise	1.8970
6	GPSVelocityNoise	1.8888
7	GyroscopeNoise	1.8847
7	AccelerometerNoise	1.7921
7	GyroscopeBiasNoise	1.7921
7	GyroscopeBiasDecayFactor	1.7845
7	AccelerometerBiasNoise	1.7845
7	AccelerometerBiasDecayFactor	1.7845
7	ZeroVelocityConstraintNoise	1.7815
7	GPSPositionNoise	1.6794
7	GPSVelocityNoise	1.6708
8	GyroscopeNoise	1.6679
8	AccelerometerNoise	1.5886
8	GyroscopeBiasNoise	1.5886
8	GyroscopeBiasDecayFactor	1.5866
8	AccelerometerBiasNoise	1.5866
8	AccelerometerBiasDecayFactor	1.5866
8	ZeroVelocityConstraintNoise	1.5850
8	GPSPositionNoise	1.5057
8	GPSVelocityNoise	1.4965
9	GyroscopeNoise	1.4950
9	AccelerometerNoise	1.4364
9	GyroscopeBiasNoise	1.4364
9	GyroscopeBiasDecayFactor	1.4364
9	AccelerometerBiasNoise	1.4364
9	AccelerometerBiasDecayFactor	1.4364
9	ZeroVelocityConstraintNoise	1.4355
9	GPSPositionNoise	1.3894
9	GPSVelocityNoise	1.3790
10	GyroscopeNoise	1.3773
10	AccelerometerNoise	1.3422
10	GyroscopeBiasNoise	1.3422
10	GyroscopeBiasDecayFactor	1.3421
10	AccelerometerBiasNoise	1.3421
10	AccelerometerBiasDecayFactor	1.3421
10	ZeroVelocityConstraintNoise	1.3399
10	GPSPositionNoise	1.3319
10	GPSVelocityNoise	1.3190
11	GyroscopeNoise	1.3159
11	AccelerometerNoise	1.3102
11	GyroscopeBiasNoise	1.3102
11	GyroscopeBiasDecayFactor	1.3100
11	AccelerometerBiasNoise	1.3100
11	AccelerometerBiasDecayFactor	1.3100
11	ZeroVelocityConstraintNoise	1.3069
11	GPSPositionNoise	1.2964
11	GPSVelocityNoise	1.2762
12	GyroscopeNoise	1.2740
12	AccelerometerNoise	1.2655
12	GyroscopeBiasNoise	1.2655
12	GyroscopeBiasDecayFactor	1.2641
12	AccelerometerBiasNoise	1.2641
12	AccelerometerBiasDecayFactor	1.2641
12	ZeroVelocityConstraintNoise	1.2631
12	GPSPositionNoise	1.2511

12	GPSVelocityNoise	1.2198
13	GyroscopeNoise	1.2184
13	AccelerometerNoise	1.2058
13	GyroscopeBiasNoise	1.2058
13	GyroscopeBiasDecayFactor	1.2029
13	AccelerometerBiasNoise	1.2029
13	AccelerometerBiasDecayFactor	1.2029
13	ZeroVelocityConstraintNoise	1.2029
13	GPSPositionNoise	1.1874
13	GPSVelocityNoise	1.1408
14	GyroscopeNoise	1.1403
14	AccelerometerNoise	1.1236
14	GyroscopeBiasNoise	1.1236
14	GyroscopeBiasDecayFactor	1.1186
14	AccelerometerBiasNoise	1.1186
14	AccelerometerBiasDecayFactor	1.1186
14	ZeroVelocityConstraintNoise	1.1183
14	GPSPositionNoise	1.0975
14	GPSVelocityNoise	1.0348
15	GyroscopeNoise	1.0347
15	AccelerometerNoise	1.0155
15	GyroscopeBiasNoise	1.0155
15	GyroscopeBiasDecayFactor	1.0081
15	AccelerometerBiasNoise	1.0081
15	AccelerometerBiasDecayFactor	1.0081
15	ZeroVelocityConstraintNoise	1.0076
15	GPSPositionNoise	0.9813
15	GPSVelocityNoise	0.9078
16	GyroscopeNoise	0.9074
16	AccelerometerNoise	0.8926
16	GyroscopeBiasNoise	0.8926
16	GyroscopeBiasDecayFactor	0.8823
16	AccelerometerBiasNoise	0.8823
16	AccelerometerBiasDecayFactor	0.8823
16	ZeroVelocityConstraintNoise	0.8815
16	GPSPositionNoise	0.8526
16	GPSVelocityNoise	0.7926
17	GyroscopeNoise	0.7920
17	AccelerometerNoise	0.7870
17	GyroscopeBiasNoise	0.7870
17	GyroscopeBiasDecayFactor	0.7742
17	AccelerometerBiasNoise	0.7742
17	AccelerometerBiasDecayFactor	0.7742
17	ZeroVelocityConstraintNoise	0.7730
17	GPSPositionNoise	0.7665
17	GPSVelocityNoise	0.7665
18	GyroscopeNoise	0.7662
18	AccelerometerNoise	0.7638
18	GyroscopeBiasNoise	0.7638
18	GyroscopeBiasDecayFactor	0.7495
18	AccelerometerBiasNoise	0.7495
18	AccelerometerBiasDecayFactor	0.7495
18	ZeroVelocityConstraintNoise	0.7482
18	GPSPositionNoise	0.7482
18	GPSVelocityNoise	0.7475
19	GyroscopeNoise	0.7474
19	AccelerometerNoise	0.7474
19	GyroscopeBiasNoise	0.7474

19	GyroscopeBiasDecayFactor	0.7474
19	AccelerometerBiasNoise	0.7474
19	AccelerometerBiasDecayFactor	0.7474
19	ZeroVelocityConstraintNoise	0.7453
19	GPSPositionNoise	0.7416
19	GPSVelocityNoise	0.7382
20	GyroscopeNoise	0.7378
20	AccelerometerNoise	0.7370
20	GyroscopeBiasNoise	0.7370
20	GyroscopeBiasDecayFactor	0.7370
20	AccelerometerBiasNoise	0.7370
20	AccelerometerBiasDecayFactor	0.7370
20	ZeroVelocityConstraintNoise	0.7345
20	GPSPositionNoise	0.7345
20	GPSVelocityNoise	0.7345
21	GyroscopeNoise	0.7334
21	AccelerometerNoise	0.7334
21	GyroscopeBiasNoise	0.7334
21	GyroscopeBiasDecayFactor	0.7334
21	AccelerometerBiasNoise	0.7334
21	AccelerometerBiasDecayFactor	0.7334
21	ZeroVelocityConstraintNoise	0.7306
21	GPSPositionNoise	0.7279
21	GPSVelocityNoise	0.7268
22	GyroscopeNoise	0.7248
22	AccelerometerNoise	0.7247
22	GyroscopeBiasNoise	0.7247
22	GyroscopeBiasDecayFactor	0.7234
22	AccelerometerBiasNoise	0.7234
22	AccelerometerBiasDecayFactor	0.7234
22	ZeroVelocityConstraintNoise	0.7207
22	GPSPositionNoise	0.7206
22	GPSVelocityNoise	0.7170
23	GyroscopeNoise	0.7138
23	AccelerometerNoise	0.7134
23	GyroscopeBiasNoise	0.7134
23	GyroscopeBiasDecayFactor	0.7134
23	AccelerometerBiasNoise	0.7134
23	AccelerometerBiasDecayFactor	0.7134
23	ZeroVelocityConstraintNoise	0.7122
23	GPSPositionNoise	0.7122
23	GPSVelocityNoise	0.7122
24	GyroscopeNoise	0.7081
24	AccelerometerNoise	0.7080
24	GyroscopeBiasNoise	0.7080
24	GyroscopeBiasDecayFactor	0.7080
24	AccelerometerBiasNoise	0.7080
24	AccelerometerBiasDecayFactor	0.7080
24	ZeroVelocityConstraintNoise	0.7080
24	GPSPositionNoise	0.7080
24	GPSVelocityNoise	0.7072
25	GyroscopeNoise	0.7009
25	AccelerometerNoise	0.7009
25	GyroscopeBiasNoise	0.7009
25	GyroscopeBiasDecayFactor	0.7007
25	AccelerometerBiasNoise	0.7007
25	AccelerometerBiasDecayFactor	0.7007
25	ZeroVelocityConstraintNoise	0.7005

25	GPSPositionNoise	0.6997
25	GPSVelocityNoise	0.6997
26	GyroscopeNoise	0.6912
26	AccelerometerNoise	0.6906
26	GyroscopeBiasNoise	0.6906
26	GyroscopeBiasDecayFactor	0.6906
26	AccelerometerBiasNoise	0.6906
26	AccelerometerBiasDecayFactor	0.6906
26	ZeroVelocityConstraintNoise	0.6896
26	GPSPositionNoise	0.6896
26	GPSVelocityNoise	0.6896
27	GyroscopeNoise	0.6840
27	AccelerometerNoise	0.6831
27	GyroscopeBiasNoise	0.6831
27	GyroscopeBiasDecayFactor	0.6831
27	AccelerometerBiasNoise	0.6831
27	AccelerometerBiasDecayFactor	0.6831
27	ZeroVelocityConstraintNoise	0.6818
27	GPSPositionNoise	0.6816
27	GPSVelocityNoise	0.6816
28	GyroscopeNoise	0.6816
28	AccelerometerNoise	0.6809
28	GyroscopeBiasNoise	0.6809
28	GyroscopeBiasDecayFactor	0.6809
28	AccelerometerBiasNoise	0.6809
28	AccelerometerBiasDecayFactor	0.6809
28	ZeroVelocityConstraintNoise	0.6804
28	GPSPositionNoise	0.6802
28	GPSVelocityNoise	0.6802
29	GyroscopeNoise	0.6793
29	AccelerometerNoise	0.6785
29	GyroscopeBiasNoise	0.6785
29	GyroscopeBiasDecayFactor	0.6785
29	AccelerometerBiasNoise	0.6785
29	AccelerometerBiasDecayFactor	0.6785
29	ZeroVelocityConstraintNoise	0.6778
29	GPSPositionNoise	0.6773
29	GPSVelocityNoise	0.6773
30	GyroscopeNoise	0.6773
30	AccelerometerNoise	0.6769
30	GyroscopeBiasNoise	0.6769
30	GyroscopeBiasDecayFactor	0.6769
30	AccelerometerBiasNoise	0.6769
30	AccelerometerBiasDecayFactor	0.6769
30	ZeroVelocityConstraintNoise	0.6769
30	GPSPositionNoise	0.6769
30	GPSVelocityNoise	0.6769

Fuse the sensor data using the tuned filter. Obtain estimated pose and orientation.

```

N = size(sensorData,1);
qEstTuned = quaternion.zeros(N,1);
posEstTuned = zeros(N,3);
for ii=1:N
    predict(filter,Accelerometer(ii,:),Gyroscope(ii,:));
    if all(~isnan(GPSPosition(ii,1)))
        fusegps(filter, GPSPosition(ii,:), ...
            tunedNoise.GPSPositionNoise,GPSVelocity(ii,:), ...

```

```
        tunedNoise.GPSVelocityNoise);
    end
    [posEstTuned(ii,:),qEstTuned(ii,:)] = pose(filter);
end
```

Compute the RMS errors.

```
orientationErrorTuned = rad2deg(dist(qEstTuned,Orientation));
rmsOrientationErrorTuned = sqrt(mean(orientationErrorTuned.^2))

rmsOrientationErrorTuned = 1.6857

positionErrorTuned = sqrt(sum((posEstTuned-Position).^2,2));
rmsPositionErrorTuned = sqrt(mean(positionErrorTuned.^2))

rmsPositionErrorTuned = 1.6667
```

Visualize the results.

```
figure;
t = (0:N-1)./filter.IMUSampleRate;
subplot(2,1,1)
plot(t,positionErrorTuned,'b');
title("Tuned insfilterNonholonomic" + newline + ...
      "Euclidean Distance Position Error")
xlabel('Time (s)');
ylabel('Position Error (meters)')
subplot(2,1,2)
plot(t,orientationErrorTuned,'b');
title("Orientation Error")
xlabel('Time (s)');
ylabel('Orientation Error (degrees)');
```

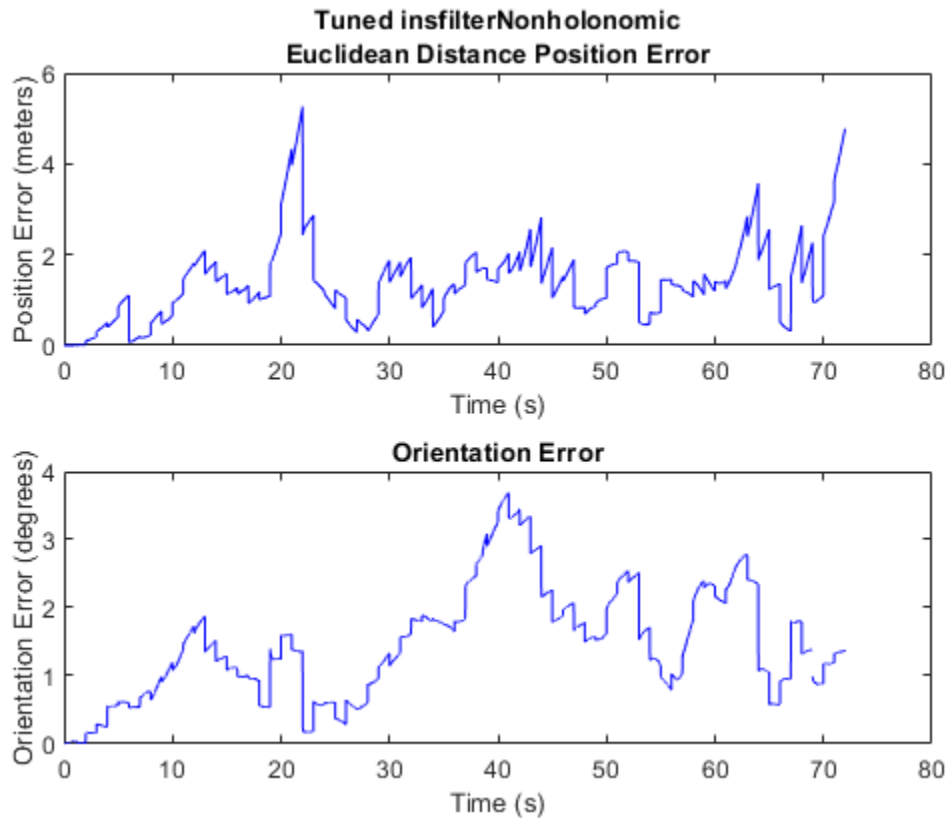

Input Arguments

filter – Filter object

`insfilterAsync` object

Filter object, specified as an `insfilterNonholonomic` object.

measureNoise – Measurement noise

structure

Measurement noise, specified as a structure. The function uses the measurement noise input as the initial guess for tuning the measurement noise. The structure must contain these fields:

Field name	Description
<code>GPSPositionNoise</code>	Variance of GPS position noise, specified as a scalar in m^2
<code>GPSVelocityNoise</code>	Variance of GPS velocity noise, specified as a scalar in $(\text{m/s})^2$

Data Types: `struct`

sensorData – Sensor data

table

Sensor data, specified as a table. In each row, the sensor data is specified as:

- **Accelerometer** — Accelerometer data, specified as a 1-by-3 vector of scalars in m^2/s .
- **Gyroscope** — Gyroscope data, specified as a 1-by-3 vector of scalars in rad/s .
- **GPSPosition** — GPS position data, specified as a 1-by-3 vector of scalars in meters.
- **GPSVelocity** — GPS velocity data, specified as a 1-by-3 vector of scalars in m/s .

If the GPS sensor does not produce complete measurements, specify the corresponding entry for **GPSPosition** and/or **GPSVelocity** as **NaN**. If you set the **Cost** property of the tuner configuration input, **config**, to **Custom**, then you can use other data types for the **sensorData** input based on your choice.

Data Types: table

groundTruth — Ground truth data table

Ground truth data, specified as a table. In each row, the table can optionally contain any of these variables:

- **Orientation** — Orientation from the navigation frame to the body frame, specified as a quaternion or a 3-by-3 rotation matrix.
- **Position** — Position in navigation frame, specified as a 1-by-3 vector of scalars in meters.
- **Velocity** — Velocity in navigation frame, specified as a 1-by-3 vector of scalars in m/s .
- **GyroscopeBias** — Gyroscope delta angle bias in body frame, specified as a 1-by-3 vector of scalars in rad/s .
- **AccelerometerBias** — Accelerometer delta angle bias in body frame, specified as a 1-by-3 vector of scalars in m^2/s .

The function processes each row of the **sensorData** and **groundTruth** tables sequentially to calculate the state estimate and RMS error from the ground truth. State variables not present in **groundTruth** input are ignored for the comparison. The **sensorData** and the **groundTruth** tables must have the same number of rows.

If you set the **Cost** property of the tuner configuration input, **config**, to **Custom**, then you can use other data types for the **groundTruth** input based on your choice.

Data Types: table

config — Tuner configuration tunerconfig object

Tuner configuration, specified as a **tunerconfig** object.

Output Arguments

tunedMeasureNoise — Tuned measurement noise structure

Tuned measurement noise, returned as a structure. The structure contains these fields.

Field name	Description
GPSPositionNoise	Variance of GPS position noise, specified as a scalar in m^2
GPSVelocityNoise	Variance of GPS velocity noise, specified as a scalar in $(m/s)^2$

Data Types: struct

References

- [1] Abbeel, Pieter, et al. "Discriminative Training of Kalman Filters." Robotics: Science and Systems I, Robotics: Science and Systems Foundation, 2005. DOI.org (Crossref), doi:10.15607/RSS.2005.I.038.

See Also

insfilterNonholonomic | tunerconfig | tunernoise

Introduced in R2020b

fuserSourceConfiguration

Configuration of source used with track fuser

Description

A `fuserSourceConfiguration` object contains the configuration information of a source used with a track fuser. A source of a track fuser is a tracking system (such as a tracker or another track fuser) that outputs tracks to the track fuser.

Creation

Syntax

```
config = fuserSourceConfiguration(SourceIndex)
config = fuserSourceConfiguration(SourceIndex,Name,Value)
```

Description

`config = fuserSourceConfiguration(SourceIndex)` creates a source configuration object to use with a track fuser. You must specify `SourceIndex` as a positive integer. The other properties of the configuration take default values.

`config = fuserSourceConfiguration(SourceIndex,Name,Value)` allows you to specify additional properties using one or more name-value pairs. Enclose each property name in single quotes.

Properties

SourceIndex — Unique index for source system

positive integer

Unique index for the source system, specified as a positive integer. This property distinguishes different source systems that output tracks to the fuser.

Example: 2

IsInternalSource — Indicate if the source is internal to the fuser

true (default) | false

Indicate if the source is internal to the fuser, specified as `true` or `false`. An internal source is a source that the fuser directly fuses tracks from even if the tracks are not self reported. For example, if the fuser is at the vehicle level, a tracking radar installed on this vehicle is considered internal, while another vehicle that reports fused tracks is considered external.

Data Types: logical

IsInitializingCentralTracks — Indicate if source can initialize central track

true (default) | false

Indicate if the source can initialize a central track in the fuser, specified as `true` or `false`. A central track is a track maintained in the fuser.

Example: `false`

Data Types: `logical`

LocalToCentralTransformFcn — Function to transform track from local to central state space

`@track(track)` (default) | function handle

Function to transform a track from local to central state space, specified as a function handle. The default transform function, `@track(track)`, makes no transformation.

Data Types: `function_handle`

CentralToLocalTransformFcn — Function to transform track from central to local state space

`@track(track)` (default) | function handle

Function to transform a track from central to local state space, specified as a function handle. The default transform function, `@track(track)`, makes no transformation.

Data Types: `function_handle`

Examples

Create Fusion Configuration for Source

Create a fusion configuration for a source with `SourceIndex` equal to 3.

```
config = fuserSourceConfiguration(3)

config =
    fuserSourceConfiguration with properties:

        SourceIndex: 3
        IsInternalSource: 1
        IsInitializingCentralTracks: 1
        LocalToCentralTransformFcn: @(track)track
        CentralToLocalTransformFcn: @(track)track
```

Extended Capabilities

C/C++ Code Generation

Generate C and C++ code using MATLAB® Coder™.

See Also

`objectTrack` | `trackFuser`

Introduced in R2019b

ggiwphd

Gamma Gaussian Inverse Wishart (GGIW) PHD filter

Description

The `ggiwphd` object is a filter that implements the probability hypothesis density (PHD) using a mixture of Gamma Gaussian Inverse-Wishart components. GGIW implementation of a PHD filter is typically used to track extended objects. An extended object can produce multiple detections per sensor, and the GGIW filter uses the random matrix model to account for the spatial distribution of these detections. The filter consists of three distributions to represent the state of an extended object.

- 1 Gaussian distribution — represents the kinematic state of the extended object.
- 2 Gamma distribution — represents the expected number of detections on a sensor from the extended object.
- 3 Inverse-Wishart (IW) distribution — represents the spatial extent of the target. In 2-D space, the extent is represented by a 2-by-2 random positive definite matrix, which corresponds to a 2-D ellipse description. In 3-D space, the extent is represented by a 3-by-3 random matrix, which corresponds to a 3-D ellipsoid description. The probability density of these random matrices is given as an Inverse-Wishart distribution.

For details about `ggiwphd`, see [1] and [2].

Note `ggiwphd` object is not compatible with `trackerGNN`, `trackerJPDA`, and `trackerTOMHT` system objects.

Creation

Syntax

```
PHD = ggiwphd
PHD = ggiwphd(States,StateCovariances)
phd = ggiwphd(States,StateCovariances,Name,Value)
```

Description

`PHD = ggiwphd` creates a `ggiwphd` filter with default property values.

`PHD = ggiwphd(States,StateCovariances)` allows you to specify the `States` and `StateCovariances` of the Gaussian distribution for each component in the density. `States` and `StateCovariances` set the properties of the same names.

`phd = ggiwphd(States,StateCovariances,Name,Value)` also allows you to set properties for the filter using one or more name-value pairs. Enclose each property name in quotes.

Properties

States — State of each component in filter

P-by-*N* matrix

State of each component in the filter, specified as a *P*-by-*N* matrix, where *P* is the dimension of the state and *N* is the number of components. Each column of the matrix corresponds to the state of each component. The default value for **States** is a 6-by-2 matrix, in which the elements of the first column are all 0, and the elements of the second column are all 1.

Data Types: `single` | `double`

StateCovariances — State estimate error covariance of each component in filter

P-by-*P*-by-*N* array

State estimate error covariance of each component in the filter, specified as a *P*-by-*P*-by-*N* array, where *P* is the dimension of the state and *N* is the number of components. Each page (*P*-by-*P* matrix) of the array corresponds to the covariance matrix of each component. The default value for **StateCovariances** is a 6-by-6-by-2 array, in which each page (6-by-6 matrix) is an identity matrix.

Data Types: `single` | `double`

PositionIndex — Indices of position coordinates in state

[1 3 5] | row vector of positive integers

Indices of position coordinates in the state, specified as a row vector of positive integers. For example, by default the state is arranged as [x;vx;y;vy;z;vz] and the corresponding position index is [1 3 5] representing x-, y- and z-position coordinates.

Example: [1 2 3]

Data Types: `single` | `double`

StateTransitionFcn — State transition function

@constvel (default) | function handle

State transition function, specified as a function handle. This function calculates the state vector at time step *k* from the state vector at time step *k*-1. The function can also include noise values.

- If **HasAdditiveProcessNoise** is `true`, specify the function using one of these syntaxes:

```
x(k) = transitionfcn(x(k-1))
```

```
x(k) = transitionfcn(x(k-1),dT)
```

where *x*(*k*) is the state estimate at time *k*, and *dT* is the time step.

- If **HasAdditiveProcessNoise** is `false`, specify the function using one of these syntaxes:

```
x(k) = transitionfcn(x(k-1),w(k-1))
```

```
x(k) = transitionfcn(x(k-1),w(k-1),dT)
```

where *x*(*k*) is the state estimate at time *k*, *w*(*k*) is the process noise at time *k*, and *dT* is the time step.

Example: @constacc

Data Types: `function_handle`

StateTransitionJacobianFcn — Jacobian of state transition function

@constveljac (default) | function handle

The Jacobian of the state transition function, specified as a function handle. This function has the same input arguments as the state transition function.

- If `HasAdditiveProcessNoise` is `true`, specify the Jacobian function using one of these syntaxes:

$$Jx(k) = \text{statejacobianfcn}(x(k))$$

$$Jx(k) = \text{statejacobianfcn}(x(k), dT)$$

where $x(k)$ is the state at time k , dT is the time step, and $Jx(k)$ denotes the Jacobian of the state transition function with respect to the state. The Jacobian is an M -by- M matrix at time k , where M is the dimension of the state.

- If `HasAdditiveProcessNoise` is `false`, specify the Jacobian function using one of these syntaxes:

$$[Jx(k), Jw(k)] = \text{statejacobianfcn}(x(k), w(k))$$

$$[Jx(k), Jw(k)] = \text{statejacobianfcn}(x(k), w(k), dT)$$

where $w(k)$ is a Q -element vector of the process noise at time k . Q is the dimension of the process noise. Unlike the case of additive process noise, the process noise vector in the nonadditive noise case need not have the same dimensions as the state vector.

$Jw(k)$ denotes the M -by- Q Jacobian of the predicted state with respect to the process noise elements, where M is the dimension of the state.

If not specified, the Jacobians are computed by numerical differencing at each call of the `predict` function. This computation can increase the processing time and numerical inaccuracy.

Example: @constaccjac

Data Types: function_handle

ProcessNoise — Process noise covariance

eye(3) (default) | positive real-valued scalar | positive-definite real-valued matrix

Process noise covariance:

- When `HasAdditiveProcessNoise` is `true`, specify the process noise covariance as a scalar or a positive definite real-valued M -by- M matrix. M is the dimension of the state vector. When specified as a scalar, the matrix is a multiple of the M -by- M identity matrix.
- When `HasAdditiveProcessNoise` is `false`, specify the process noise covariance as a Q -by- Q matrix. Q is the size of the process noise vector. You must specify `ProcessNoise` before any call to the `predict` object function.

Example: [1.0 0.05; 0.05 2]

HasAdditiveProcessNoise — Model additive process noise

false (default)

Option to model processes noise as additive, specified as `true` or `false`. When this property is `true`, process noise is added to the state vector. Otherwise, noise is incorporated into the state transition function.

Example: true

Shapes — Shape parameter of Gamma distribution for each component

[1 1] (default) | 1-by- N row vector of positive real values

Shape parameter of Gamma distribution for each component, specified as a 1-by- N row vector of positive real values. N is the number of components in the density.

Example: [1.0 0.95 2]

Data Types: single | double

Rates — Rate parameter of Gamma distribution for each component

[1 1] (default) | 1-by- N row vector of positive real value

Rate parameter of Gamma distribution for each component, specified as a 1-by- N row vector of positive real values. N is the number of components in the density.

Example: [1.2 0.85 1.5]

Data Types: single | double

GammaForgettingFactors — Forgetting factor of Gamma distribution for each component

[1 1] (default) | 1-by- N row vector of positive real value

Forgetting factor of Gamma distribution for each component, specified as a 1-by- N row vector of positive real values. N is the number of components in the density. During prediction, for each component, the Gamma distribution parameters, shape (α) and rate (β), are both divided by forgetting factor n :

$$a_{k+1} | k = \frac{\alpha_k}{n_k}$$

$$\beta_{k+1} | k = \frac{\beta_k}{n_k}$$

where k and $k+1$ represent two consecutive time steps. The mean (E) and variance (Var) of a Gamma distribution are:

$$E = \frac{\alpha}{\beta}$$

$$Var = \frac{\alpha}{\beta^2}$$

Therefore, the division action will keep the expected measurement rate as a constant, but increase the variance of the Gamma distribution exponentially with time if the forgetting factor n is larger than 1.

Example: [1.2 1.1 1.4]

Data Types: single | double

DegreesOfFreedom — Degrees of freedom parameter of Inverse-Wishart distribution for each component

[100 100] (default) | 1-by- N row vector of positive real value

Degrees of freedom parameter of Inverse-Wishart distribution for each component, specified as a 1-by- N row vector of positive real values. N is the number of components in the density.

Example: [55.2 31.1 20.4]

Data Types: single | double

ScaleMatrices — Scale matrix of Inverse-Wishart distribution for each component

d -by- d -by- N array of positive real value

Scale matrix of Inverse-Wishart distribution for each component, specified as a d -by- d -by- N array of positive real values. d is the dimension of the space (for example, $d = 2$ for 2-D space), and N is the number of components in the density. The default value for `ScaleMatrices` is a 3-by-3-by-2 array, where each page (3-by-3 matrix) of the array is `100*eye(3)`.

Example: `20*eye(3,3,4)`

Data Types: single | double

ExtentRotationFcn — Rotation transition function of target's extent

@(x,varargin)eye(3) (default) | function handle

Rotation transition function of target's extent, specified as a function handle. The function allows predicting the rotation of the target's extent when the object's angular velocity is estimated in the state vector. To define your own extent rotation function, follow the syntax given by

`R = myRotationFcn(x,dT)`

where x is the component state, dT is the time step, and R is the corresponding rotation matrix. Note that R is returned as a 2-by-2 matrix if the extent is 2-D, and a 3-by-3 matrix if the extent is 3-D. The extent at the next step is given by

$$Ex(t + dT) = R \times Ex(t) \times R^T$$

where $Ex(t)$ is the extent at time t .

Example: `@myRotationFcn`

Data Types: function_handle

TemporalDecay — Temporal decay factor of IW distribution

100 (default) | positive scalar

Temporal decay factor of IW distribution, specified as a positive scalar. You can use this property to control the extent uncertainty (variance of IW distribution) during prediction. The smaller the `TemporalDecay` value is, the faster the variance of IW distribution increases.

Example: 120

Data Types: single | double

Labels — Label of each component in mixture

[0 0] (default) | 1-by- N row vector of nonnegative integer

Label of each component in the mixture, specified as a 1-by- N row vector of nonnegative integers. N is the number of components in the density. Each component can only have one label, but multiple components can share the same label.

Example: [1 2 3]

Data Types: single | double

Weights — Weight of each component in mixture

[1 1] (default) | 1-by- N row vector of positive real value

Weight of each component in the density, specified as a 1-by- N row vector of positive real values. N is the number of components in the density. The weights are given in the sequence as shown in the `Labels` property.

Example: [1.1 0.82 1.1]

Data Types: single | double

Detections — Detections

K -element cell array of `objectDetection` objects

Detections, specified as a K -element cell array of `objectDetection` objects, where K is the number of detections. You can create detections directly, or you can obtain detections from the outputs of sensor objects, such as `radarSensor`, `monostaticRadarSensor`, `irSensor`, and `sonarSensor`.

Data Types: single | double

MeasurementFcn — Measurement model function

@cvmeas (default) | function handle

Measurement model function, specified as a function handle. This function specifies the transition from state to measurement. Input to the function is the P -element state vector. The output is the M -element measurement vector. The function can take additional input arguments, such as sensor position and orientation.

- If `HasAdditiveMeasurementNoise` is `true`, specify the function using one of these syntaxes:

$$z(k) = \text{measurementfcn}(x(k))$$

$$z(k) = \text{measurementfcn}(x(k), \text{parameters})$$

where $x(k)$ is the state at time k and $z(k)$ is the corresponding measurement. The `parameters` argument stands for all additional arguments required by the measurement function.

- If `HasAdditiveMeasurementNoise` is `false`, specify the function using one of these syntaxes:

$$z(k) = \text{measurementfcn}(x(k), v(k))$$

$$z(k) = \text{measurementfcn}(x(k), v(k), \text{parameters})$$

where $x(k)$ is the state at time k and $v(k)$ is the measurement noise at time k . The `parameters` argument stands for all additional arguments required by the measurement function.

Example: @cameas

Data Types: function_handle

MeasurementJacobianFcn — Jacobian of measurement function

@cvmeasjac (default) | function handle

Jacobian of the measurement function, specified as a function handle. The function has the same input arguments as the measurement function. The function can take additional input parameters, such as sensor position and orientation.

- If `HasAdditiveMeasurementNoise` is `true`, specify the Jacobian function using one of these syntaxes:

$$Jm_x(k) = \text{measjacobianfcn}(x(k))$$

$$Jm_x(k) = \text{measjacobianfcn}(x(k), \text{parameters})$$

where $x(k)$ is the state at time k . $Jm_x(k)$ denotes the M -by- P Jacobian of the measurement function with respect to the state. M is the dimension of the measurement, and P is the dimension of the state. The `parameters` argument stands for all arguments required by the measurement function.

- If `HasAdditiveMeasurementNoise` is `false`, specify the Jacobian function using one of these syntaxes:

$$[Jm_x(k), Jm_v(k)] = \text{measjacobianfcn}(x(k), v(k))$$

$$[Jm_x(k), Jm_v(k)] = \text{measjacobianfcn}(x(k), v(k), \text{parameters})$$

where $x(k)$ is the state at time k and $v(k)$ is an R -dimensional sample noise vector. $Jm_x(k)$ denotes the M -by- P Jacobian matrix of the measurement function with respect to the state. $Jm_v(k)$ denotes the Jacobian of the M -by- R measurement function with respect to the measurement noise. The `parameters` argument stands for all arguments required by the measurement function.

If not specified, measurement Jacobians are computed using numerical differencing at each call to the `correct` function. This computation can increase processing time and numerical inaccuracy.

Example: @cameasjac

Data Types: function_handle

HasAdditiveMeasurementNoise — Model additive measurement noise

false (default)

Option to model measurement noise as additive, specified as `true` or `false`. When this property is `true`, measurement noise is added to the state vector. Otherwise, noise is incorporated into the measurement function.

Example: true

MaxNumDetections — Maximum number of detections

100 (default) | positive integer

Maximum number of detections the `ggiwphd` filter can take as input, specified as a positive integer.

Example: 50

Data Types: single | double

MaxNumComponents — Maximum number of components

1000 (default) | positive integer

Maximum number of components the ggiwphd filter can maintain, specified as a positive integer.

Data Types: single | double

Object Functions

append	Append two phd filter objects
correct	Correct phd filter with detections
correctUndetected	Correct phd filter with no detection hypothesis
extractState	Extract target state estimates from the phd filter
labeledDensity	Keep components with a given label ID
likelihood	Log-likelihood of association between detection cells and components in the density
merge	Merge components in the density of phd filter
predict	Predict probability hypothesis density of phd filter
prune	Prune the filter by removing selected components
scale	Scale weights of components in the density
clone	Create duplicate phd filter object

Examples**Create ggiwphd Filter with Two 3-D Components**

Creating a ggiwphd filter with two 3-D constant velocity components. The initial states of the two components are [0;0;0;0;0;0] and [1;0;1;0;1;0], respectively. Both these components have position covariance equal to 1 and velocity covariance equal to 100. By default, ggiwphd creates a 3-D extent matrix for each component.

```
states = [zeros(6,1),[1;0;1;0;1;0]];
cov1 = diag([1 100 1 100 1 100]);
covariances = cat(3,cov1,cov1);

phd = ggiwphd(states,covariances,'StateTransitionFcn',@constvel,...
    'StateTransitionJacobianFcn',@constveljac,...
    'MeasurementFcn',@cvmeas,'MeasurementJacobianFcn',@cvmeasjac,...
    'ProcessNoise',eye(3),'HasAdditiveProcessNoise',false,...
    'PositionIndex',[1;3;5]);
```

Specify information about extent.

```
dofs = [21 30];
scaleMatrix1 = 13*diag([4.7 1.8 1.4].^2);
scaleMatrix2 = 22*diag([1.8 4.7 1.4].^2);
scaleMatrices = cat(3,scaleMatrix1,scaleMatrix2);
phd.DegreesOfFreedom = dofs;
phd.ScaleMatrices = scaleMatrices;
phd.ExtentRotationFcn = @(x,dT)eye(3); % No rotation during prediction
```

Predict the filter 0.1 second ahead.

```
predict(phd,0.1);
```

Specify detections at 0.1 second. The filter receives 10 detections at the current scan.

```
detections = cell(10,1);
rng(2018); % Reproducible results
for i = 1:10
    detections{i} = objectDetection(0.1,randi([0 1]) + randn(3,1));
end
phd.Detections = detections;
```

Select two detection cells and calculate their likelihoods.

```
detectionIDs = false(10,2);
detectionIDs([1 3 5 7 9],1) = true;
detectionIDs([2 4 6 8 10],2) = true;
lhood = likelihood(phd,detectionIDs)
```

```
lhood = 2×2
```

```
    1.5575    -0.3183
    0.1513    -0.7616
```

Correct the filter with the two detection cells and associated likelihoods.

```
correct(phd,detectionIDs, exp(lhood)./sum(exp(lhood),1));
phd
```

```
phd =
```

```
ggiwphd with properties:
```

```

        States: [6x4 double]
    StateCovariances: [6x6x4 double]
        PositionIndex: [3x1 double]
    StateTransitionFcn: @constvel
StateTransitionJacobianFcn: @constveljac
        ProcessNoise: [3x3 double]
    HasAdditiveProcessNoise: 0

        Shapes: [6 6 6 6]
        Rates: [2 2 2 2]
    GammaForgettingFactors: [1 1 1 1]

    DegreesOfFreedom: [25.9870 34.9780 25.9870 34.9780]
    ScaleMatrices: [3x3x4 double]
    ExtentRotationFcn: @(x,dT)eye(3)
    TemporalDecay: 100

        Weights: [0.8032 0.1968 0.6090 0.3910]
        Labels: [0 0 0 0]

        Detections: {1x10 cell}
    MeasurementFcn: @cvmeas
    MeasurementJacobianFcn: @cvmeasjac
    HasAdditiveMeasurementNoise: 1
```

Merge components in the filter.

```

merge(phd,5);
phd

phd =
  ggiwphd with properties:

          States: [6x2 double]
    StateCovariances: [6x6x2 double]
      PositionIndex: [3x1 double]
    StateTransitionFcn: @constvel
StateTransitionJacobianFcn: @constveljac
      ProcessNoise: [3x3 double]
HasAdditiveProcessNoise: 0

          Shapes: [6 6.0000]
            Rates: [2 2]
GammaForgettingFactors: [1 1]

    DegreesOfFreedom: [25.9870 34.9780]
      ScaleMatrices: [3x3x2 double]
ExtentRotationFcn: @(x,dT)eye(3)
      TemporalDecay: 100

          Weights: [1.4122 0.5878]
            Labels: [0 0]

          Detections: {1x10 cell}
    MeasurementFcn: @cvmeas
MeasurementJacobianFcn: @cvmeasjac
HasAdditiveMeasurementNoise: 1

```

Extract state estimates and detections.

```

targetStates = extractState(phd,0.5);
tStates = targetStates.State

```

```

tStates = 6x1

```

```

    0.1947
    0.9733
    0.8319
    4.1599
   -0.0124
   -0.0621

```

```

d = [detections{:}];
measurements = [d.Measurement];

```

Visualize the results.

```

figure()
plot3(measurements(1,:),measurements(2,:),measurements(3,:), 'x', 'MarkerSize',10, 'MarkerEdgeColor'
hold on;
plot3( tStates(1,:),tStates(3,:),tStates(5,:), 'ro');
xlabel('x')
ylabel('y')

```

```
zlabel('z')
legend('Detections','Components')
```

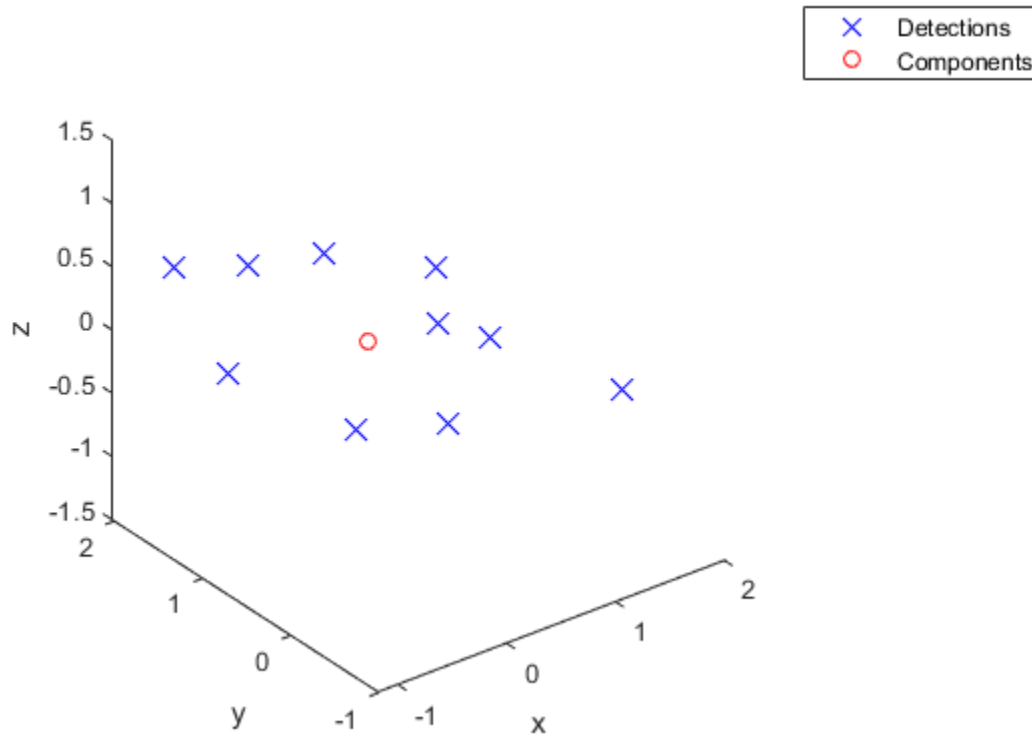

References

- [1] Granstorm, K., and O. Orguner. "A PHD filter for tracking multiple extended targets using random matrices." *IEEE Transactions on Signal Processing*. Vol. 60, Number 11, 2012, pp. 5657-5671.
- [2] Granstorm, K., and A. Natale, P. Braca, G. Ludeno, and F. Serafino. "Gamma Gaussian inverse Wishart probability hypothesis density for extended target tracking using X-band marine radar data." *IEEE Transactions on Geoscience and Remote Sensing*. Vol. 53, Number 12, 2015, pp. 6617-6631.

Extended Capabilities

C/C++ Code Generation

Generate C and C++ code using MATLAB® Coder™.

Usage notes and limitations:

- The code generation configuration must allow recursion to use merge method.

See Also

gmphd | partitionDetections | trackerPHD | trackingSensorConfiguration

Introduced in R2019a

append

Append two phd filter objects

Syntax

```
append(phd1, phd2)
```

Description

`append(phd1, phd2)` appends the components in `phd2` to the components in `phd1`. The total number of components in the appended filter must not exceed the value specified by the `MaxNumComponents` property of `phd1`.

Input Arguments

phd1 — phd filter

`ggiwphd` filter object | `gmphd` filter object

`phd` filter, specified as a `ggiwphd` filter object or a `gmphd` filter object.

Example: `phd`

Data Types: `object`

phd2 — phd filter

`ggiwphd` filter object | `gmphd` filter object

`phd` filter, specified as a `ggiwphd` filter object or a `gmphd` filter object.

Example: `phd`

Data Types: `object`

Extended Capabilities

C/C++ Code Generation

Generate C and C++ code using MATLAB® Coder™.

See Also

`ggiwphd` | `gmphd` | `trackerPHD`

Introduced in R2019a

clone

Create duplicate phd filter object

Syntax

```
phd2 = clone(phd1)
```

Description

`phd2 = clone(phd1)` creates a duplicate phd filter, `phd2`, from a phd filter, `phd1`.

Input Arguments

phd1 — phd filter

ggiwphd filter object | gmphd filter object

phd filter, specified as a ggiwphd filter object or a gmphd filter object.

Example: `phd`

Data Types: object

Output Arguments

phd2 — phd filter

ggiwphd filter object | gmphd filter object

phd filter, returned as a ggiwphd filter object or a gmphd filter object.

Example: `phd`

Data Types: object

Extended Capabilities

C/C++ Code Generation

Generate C and C++ code using MATLAB® Coder™.

See Also

ggiwphd | gmphd | trackerPHD

Introduced in R2019a

correct

Correct phd filter with detections

Syntax

```
correct(phd,detectionIndices,likelihood)
```

Description

`correct(phd,detectionIndices,likelihood)` corrects phd filter object using detections specified by `detectionIndices` and corresponding detection likelihoods, `likelihood`.

Input Arguments

phd — phd filter

ggiwphd filter object | gmphd filter object

phd filter, specified as a ggiwphd filter object or a gmphd filter object.

Example: phd

Data Types: object

detectionIndices — Indices of detection cells

M -by- P logical matrix

Indices of detection cells, specified as an M -by- P logical matrix. M is the number of detections, and P is the number of detection cells. In each column, if the value of the i th element is 1, then the i th detection belongs to the detection cell specified by this column. On the contrary, if the value of the i th element is 0, then the i th detection does not belong to the detection cell specified by this column.

Example: [1 0 0; 0 1 1; 1 1 0]

Data Types: logical

likelihood — Likelihood of association between detection cells and components

N -by- P real-valued matrix

Likelihood of association between detection cells and components in the density, specified as an N -by- P real-valued matrix. N is the number of components in the density of PHD filter, and P is the number of detection cells specified by `detectionIndices`. The (i,j) element of `likelihood` matrix represents the likelihood of association between component i and detection cell j . The weight of a component after correction is equal to its original weight multiplied by its likelihood.

Extended Capabilities

C/C++ Code Generation

Generate C and C++ code using MATLAB® Coder™.

See Also

ggiwphd | gmphd | trackerPHD

Introduced in R2019a

correctUndetected

Correct phd filter with no detection hypothesis

Syntax

```
correctUndetect(phd, Pd)
correctUndetect(phd, Pd, PzeroDets)
```

Description

`correctUndetect(phd, Pd)` corrects the phd filter, `phd`, with the sensor detection probability, `Pd`. If used with `ggiwphd`, the function calculates the probability of generating zero detections using the current Gamma distribution of the filter. If used with `gmphd`, the probability of generating zero detections is assumed to be zero.

`correctUndetect(phd, Pd, PzeroDets)` allows you to specify the conditional probability for generating zero detections using `PzeroDets`.

Input Arguments

phd — phd filter

`ggiwphd` filter object | `gmphd` filter object

phd filter, specified as a `ggiwphd` filter object or a `gmphd` filter object.

Example: `phd`

Data Types: `object`

Pd — Sensor's detection probability for each component

1-by- N real-valued row vector

Sensor's detection probability for each component in the density of the PHD filter, specified as a 1-by- N real-valued row vector, where N is the number of components.

Example: `[0.5 0.6 0.55]`

Data Types: `single` | `double`

PzeroDets — Probability of generating zero detection for each component

1-by- N real-valued row vector

Probability of generating zero detection for each component in the density of the PHD filter, specified as a 1-by- N real-valued row vector, where N is the number of components.

Example: `[0.1 0.2 0.15]`

Data Types: `single` | `double`

Extended Capabilities

C/C++ Code Generation

Generate C and C++ code using MATLAB® Coder™.

See Also

[ggiwphd](#) | [gmphd](#) | [trackerPHD](#)

Introduced in R2019a

extractState

Extract target state estimates from the phd filter

Syntax

```
[States,Indices] = extractState(phd,threshold)
```

Description

[States,Indices] = extractState(phd,threshold) returns all sates of components, States, whose weights are above the threshold given by threshold, and their corresponding indices, Indices, in the phd filter, phd.

Input Arguments

phd — phd filter

ggiwphd filter object | gmphd filter object

phd filter, specified as a ggiwphd filter object or a gmphd filter object.

Example: phd

Data Types: object

threshold — Extraction threshold

real positive scalar

Extraction threshold of component weight, specified as a real positive scalar.

Example: 0.2

Data Types: single | double

Output Arguments

States — Extracted states

structure | 1-by- N array of structure

Extracted states, returned as a structure or a 1-by- N array of structure, where N is the number of extracted states. Given the type of the phd filter, each structure contains:

- ggiwphd:

Field	Description
State	State estimate of the target.
StateCovariance	Uncertainty covariance matrix.
Extent	Spatial extent estimate of the tracked object, returned as a d -by- d matrix, where d is the dimension of the object.

MeasurementRate	Expected number of detections from the tracked object.
-----------------	--

- gmphd:

Field	Description
State	State estimate of the target.
StateCovariance	Uncertainty covariance matrix.

Data Types: struct

Indices — Indices of extracted states

1-by- N vector of nonnegative integers

Indices of extracted states, returned as an 1-by- N vector of nonnegative integers, where N is the number of extracted states. Each element of the vector is the index of the corresponding extracted state in `States`.

Data Types: double

Extended Capabilities

C/C++ Code Generation

Generate C and C++ code using MATLAB® Coder™.

See Also

ggiwphd | gmphd | trackerPHD

Introduced in R2019a

labeledDensity

Keep components with a given label ID

Syntax

```
labeledDensity(phd,labelID)
```

Description

`labeledDensity(phd,labelID)` keeps components with the specified `labelID` and removes all other components in the density.

Input Arguments

phd — phd filter

`ggiwphd` filter object | `gmphd` filter object

`phd` filter, specified as a `ggiwphd` filter object or a `gmphd` filter object.

Example: `phd`

Data Types: `object`

labelID — label ID of reserved components

nonnegative integer

label ID of the components to be kept, specified as a nonnegative integer.

Example: `1`

Data Types: `double`

Extended Capabilities

C/C++ Code Generation

Generate C and C++ code using MATLAB® Coder™.

See Also

`ggiwphd` | `gmphd` | `trackerPHD`

Introduced in R2019a

likelihood

Log-likelihood of association between detection cells and components in the density

Syntax

```
lhood = likelihood(phd,detectionIndices)
```

Description

`lhood = likelihood(phd,detectionIndices)` returns the log-likelihood of association between detection cells specified by `detectionIndices`, and components in the `phd` filter, `phd`.

Input Arguments

phd — **phd filter**

`ggiwphd` filter object | `gmphd` filter object

`phd` filter, specified as a `ggiwphd` filter object or a `gmphd` filter object.

Example: `phd`

Data Types: `object`

detectionIndices — **Indices of detection cells**

M -by- P logical matrix

Indices of detection cells, specified as an M -by- P logical matrix. M is the number of detections, and P is the number of detection cells. In each column, if the value of the i th element is 1, then the i th detection belongs to the detection cell specified by this column. On the contrary, if the value of the i th element is 0, then the i th detection does not belong to the detection cell specified by this column.

Example: `[1 0 0; 0 1 1; 1 1 0]`

Data Types: `logical`

Output Arguments

lhood — **log-likelihood of association between detection cells and components**

N -by- P real-valued matrix

Log-likelihood of association between detection cells and components in the density, specified as an N -by- P real-valued matrix. N is the number of components in the density of PHD filter, and P is the number of detection cells specified by `detectionIndices`. The (i,j) element of `lhood` matrix represents the log-likelihood of association between component i and detection cell j .

Extended Capabilities

C/C++ Code Generation

Generate C and C++ code using MATLAB® Coder™.

See Also

ggiwphd | gmphd | trackerPHD

Introduced in R2019a

merge

Merge components in the density of `phd` filter

Syntax

```
merge(phd,mergingThreshold)
```

Description

`merge(phd,mergingThreshold)` merges components whose Kullback-Leibler difference is below the threshold, `mergingThreshold`.

Input Arguments

phd — **phd filter**

`ggiwphd` filter object | `gmphd` filter object

`phd` filter, specified as a `ggiwphd` filter object or a `gmphd` filter object.

Example: `phd`

Data Types: `object`

mergingThreshold — **Threshold for components merging**

real positive scalar

Threshold for components merging, specified as a real positive scalar. If the Kullback-Leibler difference between two components is smaller than the value specified by the `mergingThreshold` argument, then these two components will be merged into one component. The merged weight of the new component is equal to the summation of the weights of the two pre-merged components.

Example: 30

Data Types: `single` | `double`

Extended Capabilities

C/C++ Code Generation

Generate C and C++ code using MATLAB® Coder™.

See Also

`ggiwphd` | `gmphd` | `trackerPHD`

Introduced in R2019a

predict

Predict probability hypothesis density of phd filter

Syntax

```
predict(phd,dt)
```

Description

`predict(phd,dt)` predicts the density of the phd filter object, `phd`, forward by time step, `dt`.

Input Arguments

phd — phd filter

`ggiwphd` filter object | `gmphd` filter object

phd filter, specified as a `ggiwphd` filter object or a `gmphd` filter object.

Example: `phd`

Data Types: `object`

dt — time step of prediction

real positive scalar

Time step of prediction, specified as a real positive scalar.

Example: `0.1`

Data Types: `double`

Extended Capabilities

C/C++ Code Generation

Generate C and C++ code using MATLAB® Coder™.

See Also

`ggiwphd` | `gmphd` | `trackerPHD`

Introduced in R2019a

prune

Prune the filter by removing selected components

Syntax

```
prune(phd,pruneIndices)
```

Description

`prune(phd,pruneIndices)` removes components in `phd` filter object, `phd`, specified by `pruneIndices`.

Input Arguments

phd — phd filter

`ggiwphd` filter object | `gmphd` filter object

`phd` filter, specified as a `ggiwphd` filter object or a `gmphd` filter object.

Example: `phd`

Data Types: `object`

pruneIndices — Indices of components to be pruned

1-by- N logical vector

Indices of components to be pruned, specified as an 1-by- N logical vector, where N is the number of components in the density. If the i th element of the vector is 1 instead of 0, then the i th component will be removed from the density.

Example: `[0 1 0 1 0 0]`

Data Types: `logical`

Extended Capabilities

C/C++ Code Generation

Generate C and C++ code using MATLAB® Coder™.

See Also

`ggiwphd` | `gmphd` | `trackerPHD`

Introduced in R2019a

scale

Scale weights of components in the density

Syntax

```
scale(phd,ScaleFactor)
```

Description

`scale(phd,ScaleFactor)` scales the weights of components in the density of the `phd` filter, `phd`, by factor, `ScaleFactor`.

Input Arguments

phd — **phd filter**

`ggiwphd` filter object | `gmphd` filter object

`phd` filter, specified as a `ggiwphd` filter object or a `gmphd` filter object.

Example: `phd`

Data Types: `object`

ScaleFactor — **Scale factor**

positive scalar | 1-by- N vector of positive scalars

Scale factor of components in the density, specified as a positive scalar, or an 1-by- N vector of positive scalars, where N is the number of components in the density. If the scale factor is specified as a scalar, then the weight of each component is multiplied by this scalar. If the scale factor is specified as a vector, then the weight of each component is multiplied by the corresponding element in the vector.

Example: `[0.9 1.1 0.8]`

Data Types: `single` | `double`

Extended Capabilities

C/C++ Code Generation

Generate C and C++ code using MATLAB® Coder™.

See Also

`ggiwphd` | `gmphd` | `trackerPHD`

Introduced in R2019a

gmphd

Gaussian mixture (GM) PHD filter

Description

The `gmphd` object is a filter that implements the probability hypothesis density (PHD) using a mixture of Gaussian components. The filter assumes the target states are Gaussian and represents these states using a mixture of Gaussian components. You can use a `gmphd` filter to track extended objects or point targets. In tracking, a point object returns at most one detection per sensor scan, and an extended object can return multiple detections per sensor scan.

You can directly create a `gmphd` filter. You can also initialize a `gmphd` filter used with `trackerPHD` by specifying the `FilterInitializationFcn` property of `trackingSensorConfiguration`. You can use the provided `initcvgmphd`, `initctgmphd`, `initcagmpdh`, and `initctrectgmphd` as initialization functions. Or, you can create your own initialization functions.

Creation

Syntax

```
phd = gmphd
phd = gmphd(states, stateCovariances)
phd = gmphd(states, stateCovariances, Name, Value)
```

Description

`phd = gmphd` creates a `gmphd` filter with default property values.

`phd = gmphd(states, stateCovariances)` allows you to specify the states and corresponding state covariances of the Gaussian distribution for each component in the density. `states` and `stateCovariances` set the `States` and `StateCovariances` properties of the filter.

`phd = gmphd(states, stateCovariances, Name, Value)` also allows you to specify properties for the filter using one or more name-value pairs. Enclose each property name in quotes.

Properties

States — State of each component in filter

P-by-*N* matrix

State of each component in the filter, specified as a *P*-by-*N* matrix, where *P* is the dimension of the state and *N* is the number of components. Each column of the matrix corresponds to the state of one component. The default value for `States` is a 6-by-2 matrix, in which the elements of the first column are all 0, and the elements of the second column are all 1.

Data Types: `single` | `double`

StateCovariances — State estimate error covariance of each component in filter*P*-by-*P*-by-*N* array

State estimate error covariance of each component in the filter, specified as a *P*-by-*P*-by-*N* array, where *P* is the dimension of the state and *N* is the number of components. Each page (*P*-by-*P* matrix) of the array corresponds to the covariance matrix of each component. The default value for `StateCovariances` is a 6-by-6-by-2 array, in which each page (6-by-6 matrix) is an identity matrix.

Data Types: `single` | `double`**StateTransitionFcn — State transition function**`@constvel` (default) | function handle

State transition function, specified as a function handle. This function calculates the state vector at time step *k* from the state vector at time step *k*-1. The function can also include noise values.

- If `HasAdditiveProcessNoise` is `true`, specify the function using one of these syntaxes:

$$x(k) = \text{transitionfcn}(x(k-1))$$

$$x(k) = \text{transitionfcn}(x(k-1), dT)$$

where $x(k)$ is the state estimate at time *k*, and *dT* is the time step.

- If `HasAdditiveProcessNoise` is `false`, specify the function using one of these syntaxes:

$$x(k) = \text{transitionfcn}(x(k-1), w(k-1))$$

$$x(k) = \text{transitionfcn}(x(k-1), w(k-1), dT)$$

where $x(k)$ is the state estimate at time *k*, $w(k)$ is the process noise at time *k*, and *dT* is the time step.

For more details on the state transition model, see “Algorithms” on page 2-466 for `trackingEKF`.

Example: `@constacc`Data Types: `function_handle`**StateTransitionJacobianFcn — Jacobian of state transition function**`@constveljac` (default) | function handle

Jacobian of the state transition function, specified as a function handle. This function has the same input arguments as the state transition function.

- If `HasAdditiveProcessNoise` is `true`, specify the Jacobian function using one of these syntaxes:

$$Jx(k) = \text{statejacobianfcn}(x(k))$$

$$Jx(k) = \text{statejacobianfcn}(x(k), dT)$$

where $x(k)$ is the state at time *k*, *dT* is the time step, and $Jx(k)$ denotes the Jacobian of the state transition function with respect to the state. The Jacobian is a *P*-by-*P* matrix at time *k*, where *P* is the dimension of the state.

- If `HasAdditiveProcessNoise` is `false`, specify the Jacobian function using one of these syntaxes:

$$[Jx(k), Jw(k)] = \text{statejacobianfcn}(x(k), w(k))$$

```
[Jx(k),Jw(k)] = statejacobianfcn(x(k),w(k),dT)
```

where $w(k)$ is a Q -element vector of the process noise at time k . Unlike the case of additive process noise, the process noise vector in the non-additive noise case doesn't need to have the same dimensions as the state vector.

$Jw(k)$ denotes the P -by- Q Jacobian of the predicted state with respect to the process noise elements, where P is the dimension of the state.

If not specified, the Jacobians are computed by numerical differencing at each call of the `predict` function. This computation can increase the processing time and numerical inaccuracy.

Example: `@constaccjac`

Data Types: `function_handle`

ProcessNoise — Process noise covariance

`eye(3)` (default) | positive real-valued scalar | positive definite real-valued matrix

Process noise covariance:

- When `HasAdditiveProcessNoise` is `true`, specify the process noise covariance as a real-valued scalar or a positive definite P -by- P matrix. P is the dimension of the state vector. When specified as a scalar, the matrix is a multiple of the P -by- P identity matrix.
- When `HasAdditiveProcessNoise` is `false`, specify the process noise covariance as a Q -by- Q matrix. Q is the size of the process noise vector. You must specify `ProcessNoise` before any call to the `predict` object function.

Example: `[1.0 0.05; 0.05 2]`

HasAdditiveProcessNoise — Model additive process noise

`false` (default) | `true`

Option to model process noise as additive, specified as `true` or `false`. When this property is `true`, process noise is added to the state vector. Otherwise, noise is incorporated into the state transition function.

Example: `true`

HasExtent — Indicate if components have extent

`false` (default) | `true`

Indicate if components have extent, specified as `true` or `false`. Set this property to `true` if the filter is intended to track extended objects. An extended object can generate more than one measurement per sensor scan. Set this property to `false` if the filter is only intended to track point targets.

Example: `true`

MeasurementOrigin — Origination of measurements from extended objects

`'center'` (default) | `'extent'`

Origination of measurements from extended objects, specified as:

- `'center'` — The filter assumes the measurements originate from the mean state of a target. This approach is applicable when the state does not model the extent of the target even though the target may generate more than one measurement.

- 'extent' — The filter assumes measurements are not centered at the mean state of a target. For computational efficiency, the expected measurement is often calculated as a function of the reported measurements specified by the measurement model function.

Note that the function setups of `MeasurementFcn` and `MeasurementJacobianFcn` are different for 'center' and 'extent' options. See the descriptions of `MeasurementFcn` and `MeasurementJacobianFcn` for more details.

Dependencies

To enable this property, set the `HasExtent` property to 'true'.

Data Types: `double`

Labels — Label of each component in mixture

[0 0] (default) | 1-by-*N* row vector of nonnegative integer

Label of each component in the mixture, specified as a 1-by-*N* row vector of nonnegative integers. *N* is the number of components in the mixture. Each component can only have one label, but multiple components can share the same label.

Example: [1 2 3]

Data Types: `single` | `double`

Weights — Weight of each component in mixture

[1 1] (default) | 1-by-*N* row vector of positive real value

Weight of each component in the mixture, specified as a 1-by-*N* row vector of positive real values. *N* is the number of components in the mixture. The weight of each component is given in the same order as the `Labels` property.

Example: [1.1 0.82 1.1]

Data Types: `single` | `double`

Detections — Detections

D-element cell array of `objectDetection` objects

Detections, specified as a *D*-element cell array of `objectDetection` objects. You can create detections directly, or you can obtain detections from the outputs of sensor objects, such as `radarSensor`, `monostaticRadarSensor`, `irSensor`, and `sonarSensor`.

Data Types: `single` | `double`

MeasurementFcn — Measurement model function

@`cvmeas` (default) | function handle

Measurement model function, specified as a function handle. This function specifies the transition from state to measurement. Depending on the `HasExtent` and `MeasurementOrigin` properties, the measurement model function needs to be specified differently:

- 1 `HasExtent` is false, or `HasExtent` is true and `MeasurementOrigin` is 'center'. In these two cases,

- If `HasAdditiveMeasurementNoise` is true, specify the function using one of these syntaxes:

```
z = measurementfcn(x)
```

```
z = measurementfcn(x,parameters)
```

where the P -by- N matrix x is the estimated Gaussian states at time k and $x(:,i)$ represents the i th state component in the mixture. The M -by- N matrix z is the corresponding measurement, and $z(:,i)$ represents the measurement resulting from the i th component. Parameters are `MeasurementParameters` provided in the `objectDetections` set in the `Detections` property.

- If `HasAdditiveMeasurementNoise` is `false`, specify the function using one of these syntaxes:

```
z = measurementfcn(x,v)
```

```
z = measurementfcn(x,v,parameters)
```

where v is an R -dimensional measurement noise vector.

- 2 `HasExtent` is `true` and `MeasurementOrigin` is `'extent'`. In this case, the expected measurements originate from the extent of the target and rely on the actual distribution of the detections:

- If `HasAdditiveMeasurementNoise` is `true`, specify the function using:

```
z = measurementfcn(x,detections)
```

where the P -by- N matrix x is the estimated Gaussian states at time k and $x(:,i)$ represents the i th state component in the mixture. `detections` is a cell array of `objectDetection` objects, and z is the expected measurement. Note that $z(:,i,j)$ must return the expected measurement based on the i th state component and the j th `objectDetection` in `detections`.

- If `HasAdditiveMeasurementNoise` is `false`, specify the function using:

```
z = measurementfcn(x,v,detections)
```

where v is an R -dimensional measurement noise vector.

HasExtent	MeasurementOrigin	Measurement Function		Note
false	NA	HasAdditiveMeasurementNoise	Syntaxes	$x(:,i)$ represents the i th state component in the mixture. $z(:,i)$ represents the measurement resulting from the i th component.
true	'center'	true	<pre>z = measurementfcn(x)</pre> <pre>z = measurementfcn(x,para)</pre>	
		false	<pre>z = measurementfcn(x,v)</pre> <pre>z = measurementfcn(x,v,para)</pre>	

true	'extent'	HasAdditiveMeasurementNoise	Syntaxes	$x(:, i)$ represents the i th state component in the mixture. $z(:, i, j)$ must return the expected measurement based on the i th state component and the j th objectDetection in detections.
		true	$z = \text{measurementfcn}(x, \text{detections})$	
		false	$z = \text{measurementfcn}(x, v, \text{detections})$	

Data Types: function_handle

MeasurementJacobianFcn — Jacobian of measurement function

@cvmeasjac (default) | function handle

Jacobian of the measurement function, specified as a function handle. Depending on the HasExtent and MeasurementOrigin properties, the measurement Jacobian function needs to be specified differently:

- 1 HasExtent is false, or HasExtent is true and MeasurementOrigin is 'center'. In these two cases:

- If HasAdditiveMeasurementNoise is true, specify the Jacobian function using one of these syntaxes:

$J_{mx} = \text{measjacobianfcn}(x)$

$J_{mx} = \text{measjacobianfcn}(x, \text{parameters})$

where the P -element vector x is one state component at time k and J_{mx} is the M -by- P Jacobian of the measurement function with respect to the state. M is the dimension of the measurement. Parameters are MeasurementParameters provided in the objectDetections set in the Detections property.

- If HasAdditiveMeasurementNoise is false, specify the Jacobian function using one of these syntaxes:

$[J_{mx}, J_{mv}] = \text{measjacobianfcn}(x, v)$

$[J_{mx}, J_{mv}] = \text{measjacobianfcn}(x, v, \text{parameters})$

where v is an R -dimensional measurement noise vector, and J_{mv} is the M -by- R Jacobian of the measurement function with respect to the measurement noise.

- 2 **HasExtent** is `true` and **MeasurementOrigin** is `'extent'`. In this case, the expected measurements originate from the extent of the target and rely on the actual distribution of the detections. The measurement Jacobian function must support one of these two syntaxes:

- If **HasAdditiveMeasurementNoise** is `true`, specify the Jacobian function using:

```
Jmx = measjacobianfcn(x,detections)
```

where x is one state estimate component at time k . `detections` is a set of detections defined as a cell array of `objectDetection` objects. J_{mx} denotes the M -by- P -by- D Jacobian of the measurement function with respect to the state. M is the dimension of the measurement, P is the dimension of the state, and D is the number of `objectDetection` objects in `detections`.

- If **HasAdditiveMeasurementNoise** is `false`, specify the Jacobian function using:

```
[Jmx,Jmv] = measjacobianfcn(x,v,detections)
```

where v is an R -dimensional measurement noise vector, and J_{mv} is the M -by- R -by- D Jacobian of the measurement function with respect to the measurement noise.

Note that $J_{mx}(:, :, j)$ must define the state Jacobian corresponding to the j th `objectDetection` in `detections`. $J_{mv}(:, :, j)$ defines the measurement noise Jacobian corresponding to the j th `objectDetection` in `detections`.

HasExtent	MeasurementOrigin	Measurement Jacobian Function		Note
false	NA	HasAdditiveMeasurementNoise	Syntaxes	x is only one Gaussian component in the mixture.
true	'center'	true	$J_{mx} = \text{measjacobianfcn}(x)$ $J_{mx} = \text{measjacobianfcn}(x, \text{para})$	
		false	$[J_{mx}, J_{mv}] = \text{measjacobianfcn}(x, v)$ $[J_{mx}, J_{mv}] = \text{measjacobianfcn}(x, v, \text{para})$	

true	'extent'	HasAdditiveMeasurementNoise	Syntaxes	$J_{mx}(:, :, j)$ defines the state Jacobian corresponding to the j th objectDetection in detections. $J_{mv}(:, :, j)$ defines the measurement noise Jacobian corresponding to the j th objectDetection in detections.
		true	$z = \text{measurementfcn}(x, \text{detections})$	
		false	$z = \text{measurementfcn}(x, v, \text{detections})$	

Data Types: function_handle

HasAdditiveMeasurementNoise – Model additive measurement noise

false (default) | true

Option to model measurement noise as additive, specified as true or false. When this property is true, measurement noise is added to the state vector. Otherwise, noise is incorporated into the measurement function.

Example: true

MaxNumDetections – Maximum number of detections

1000 (default) | positive integer

Maximum number of detections the gmphd filter can take as input, specified as a positive integer.

Example: 50

Data Types: single | double

MaxNumComponents – Maximum number of components

1000 (default) | positive integer

Maximum number of components the gmphd filter can maintain, specified as a positive integer.

Data Types: single | double

Object Functions

predict	Predict probability hypothesis density of phd filter
correctUndetected	Correct phd filter with no detection hypothesis
correct	Correct phd filter with detections
likelihood	Log-likelihood of association between detection cells and components in the density
append	Append two phd filter objects
merge	Merge components in the density of phd filter
scale	Scale weights of components in the density
prune	Prune the filter by removing selected components
labeledDensity	Keep components with a given label ID
extractState	Extract target state estimates from the phd filter
clone	Create duplicate phd filter object

Examples

Run gmphd Filter for Point Objects

Create a filter with two 3-D constant velocity components. The initial state of one component is [0;0;0;0;0;0]. The initial state of the other component is [1;0;1;0;1;0]. Each component is initialized with position covariance equal to 1 and velocity covariance equal to 100.

```
states = [zeros(6,1) [1;0;1;0;1;0]];
cov1 = diag([1 100 1 100 1 100]);
covariances = cat(3,cov1,cov1);
phd = gmphd(states, covariances, 'StateTransitionFcn', @constvel,...
    'StateTransitionJacobianFcn', @constveljac,...
    'MeasurementFcn', @cvmeas,...
    'MeasurementJacobianFcn', @cvmeasjac,...
    'ProcessNoise', eye(3),...
    'HasAdditiveProcessNoise', false);
```

Predict the filter 0.1 time step ahead.

```
predict(phd,0.1);
```

Define three detections using `objectDetection`.

```
rng(2019);
detections = cell(3,1);
detections{1} = objectDetection(0,[1;1;1] + randn(3,1));
detections{2} = objectDetection(0,[0;0;0] + randn(3,1));
detections{3} = objectDetection(0,[4;5;5] + randn(3,1));
phd.Detections = detections;
```

Calculate the likelihood of each detection. For a point-target filter, the partition of detections is unnecessary, and each detection occupies a cell. Therefore, `detectionIndices` is an identity matrix. The resulting likelihood of detection 1 and 2 is higher than that of detection 3 because they are closer to the components.

```
detectionIndices = logical(eye(3));
logLikelihood = likelihood(phd,detectionIndices)
```

```
logLikelihood = 2×3
    -5.2485    -4.7774   -22.8899
    -4.5171    -5.0008   -17.3973
```

Correct the filter with the scaled likelihood.

```
lhood = exp(logLikelihood);
lhood = lhood./sum(lhood,2);
correct(phd,detectionIndices,lhood);
```

Merge the components with a merging threshold equal to 1.

```
merge(phd,1);
```

Extract state estimates with an extract threshold equal to 0.5.

```
minWeight = 0.5;
targetStates = extractState(phd,minWeight);
[ts1,ts2]= targetStates.State;
```

Visualize the results.

```
% Extract the measurements.
d = [detections{:}];
measurements = [d.Measurement];
% Plot the measurements and estimates.
figure()
plot3(measurements(1,:),measurements(2,:),measurements(3,:), 'x', 'MarkerSize',10, 'MarkerEdgeColor'
hold on;
plot3(ts1(1),ts1(3),ts1(5), 'ro');
hold on;
plot3(ts2(1),ts2(3),ts2(5), 'ro');
xlabel('x')
ylabel('y')
zlabel('z')
hold on;
legend('Detections','Components')
```

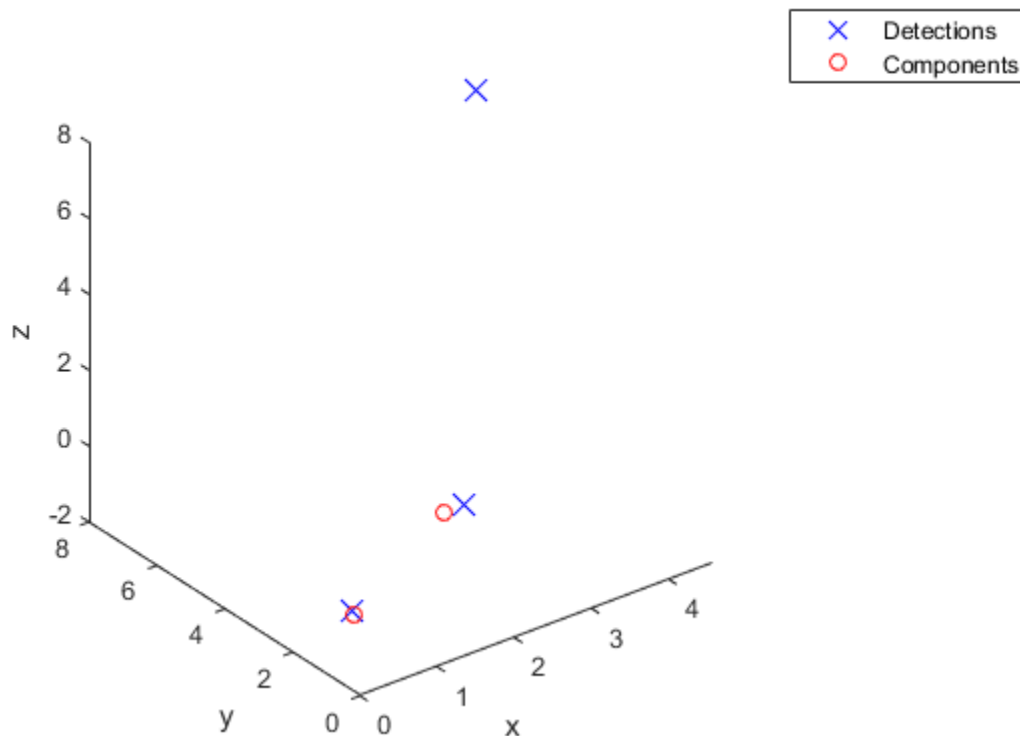

References

- [1] Vo, B. -T, and W. K. Ma. "The Gaussian mixture Probability Hypothesis Density Filter." *IEEE Transactions on Signal Processing*, Vol, 54, No, 11, pp. 4091-4104, 2006.
- [2] Granstrom, Karl, Christian Lundquist, and Omut Orguner. "Extended target tracking using a Gaussian-mixture PHD filter." *IEEE Transactions on Aerospace and Electronic Systems* 48, no. 4 (2012): 3268-3286.

Extended Capabilities

C/C++ Code Generation

Generate C and C++ code using MATLAB® Coder™.

Usage notes and limitations:

- The code generation configuration must allow recursion to use the merge method.

See Also

ggiwphd | initcagmphd | initctgmphd | initctrectgmphd | initcvgmphd | partitionDetections | trackerPHD | trackingSensorConfiguration

Introduced in R2019b

pose

Current orientation and position estimate for `insfilterNonholonomic`

Syntax

```
[position,orientation,velocity] = pose(FUSE)
[position,orientation,velocity] = pose(FUSE,format)
```

Description

`[position,orientation,velocity] = pose(FUSE)` returns the current estimate of the pose.

`[position,orientation,velocity] = pose(FUSE,format)` returns the current estimate of the pose with orientation in the specified orientation format.

Input Arguments

FUSE — NHConstrainedIMUGPSFuser object

object

`insfilterNonholonomic`, specified as an object.

format — Output orientation format

'quaternion' (default) | 'rotmat'

Output orientation format, specified as either 'quaternion' for a quaternion or 'rotmat' for a rotation matrix.

Data Types: char | string

Output Arguments

position — Position estimate in the local NED coordinate system (m)

3-element row vector

Position estimate in the local NED coordinate system in meters, returned as a 3-element row vector.

Data Types: single | double

orientation — Orientation estimate in the local NED coordinate system

quaternion (default) | 3-by-3 rotation matrix

Orientation estimate in the local NED coordinate system, specified as a scalar quaternion or 3-by-3 rotation matrix. The quaternion or rotation matrix represents a frame rotation from the local NED reference frame to the body reference frame.

Data Types: single | double | quaternion

velocity — Velocity estimate in local NED coordinate system (m/s)

3-element row vector

Velocity estimate in the local NED coordinate system in m/s, returned as a 3-element row vector.

Data Types: `single` | `double`

Extended Capabilities

C/C++ Code Generation

Generate C and C++ code using MATLAB® Coder™.

See Also

`insfilter` | `insfilterNonholonomic`

Introduced in R2018b

predict

Update states using accelerometer and gyroscope data for `insfilterNonholonomic`

Syntax

```
predict(FUSE, accelReadings, gyroReadings)
```

Description

`predict(FUSE, accelReadings, gyroReadings)` fuses accelerometer and gyroscope data to update the state estimate.

Input Arguments

FUSE — `insfilterNonholonomic` object

object

`insfilterNonholonomic`, specified as an object.

accelReadings — Accelerometer readings in local sensor body coordinate system (m/s²)

3-element row vector

Accelerometer readings in m/s², specified as a 3-element row vector.

Data Types: `single` | `double`

gyroReadings — Gyroscope readings in local sensor body coordinate system (rad/s)

3-element row vector

Gyroscope readings in rad/s, specified as a 3-element row vector.

Data Types: `single` | `double`

Extended Capabilities

C/C++ Code Generation

Generate C and C++ code using MATLAB® Coder™.

See Also

`insfilter` | `insfilterNonholonomic`

Introduced in R2018b

reset

Reset internal states for `insfilterNonholonomic`

Syntax

`reset(FUSE)`

Description

`reset(FUSE)` resets the State, StateCovariance, and internal integrators to their default values.

Input Arguments

FUSE — `insfilterNonholonomic` object

object

`insfilterNonholonomic`, specified as an object.

Extended Capabilities

C/C++ Code Generation

Generate C and C++ code using MATLAB® Coder™.

See Also

`insfilter` | `insfilterNonholonomic`

Introduced in R2018b

stateinfo

Display state vector information for `insfilterNonholonomic`

Syntax

```
stateinfo(FUSE)
info = stateinfo(FUSE)
```

Description

`stateinfo(FUSE)` displays the meaning of each index of the State property and the associated units.

`info = stateinfo(FUSE)` returns a structure with fields containing descriptions of the elements of the state vector of the filter, FUSE.

Examples

State information of `insfilterNonholonomic`

Create an `insfilterNonholonomic` object.

```
filter = insfilterErrorState;
```

Display the state information of the created filter.

```
stateinfo(filter)

States                Units    Index
Orientation (quaternion parts)    1:4
Position (NAV)                   m       5:7
Velocity (NAV)                    m/s     8:10
Gyroscope Bias (XYZ)              rad/s   11:13
Accelerometer Bias (XYZ)          m/s2   14:16
Visual Odometry Scale             17
```

Output the state information of the filter as a structure.

```
info = stateinfo(filter)

info = struct with fields:
    Orientation: [1 2 3 4]
    Position: [5 6 7]
    Velocity: [8 9 10]
    GyroscopeBias: [11 12 13]
    AccelerometerBias: [14 15 16]
    VisualOdometryScale: 17
```

Input Arguments

FUSE — `insfilterNonholonomic` object
object

`insfilterNonholonomic`, specified as an object.

Output Arguments

info — State information
structure

State information, returned as a structure with fields containing descriptions of the elements of the state vector of the filter. The values of each field are the corresponding indices of the state vector.

Extended Capabilities

C/C++ Code Generation

Generate C and C++ code using MATLAB® Coder™.

See Also

`insfilter` | `insfilterNonholonomic`

Introduced in R2018b

insfilterNonholonomic

Estimate pose with nonholonomic constraints

Description

The `insfilterNonholonomic` object implements sensor fusion of inertial measurement unit (IMU) and GPS data to estimate pose in the NED (or ENU) reference frame. IMU data is derived from gyroscope and accelerometer data. The filter uses a 16-element state vector to track the orientation quaternion, velocity, position, and IMU sensor biases. The `insfilterNonholonomic` object uses an extended Kalman filter to estimate these quantities.

Creation

Syntax

```
filter = insfilterNonholonomic
filter = insfilterNonholonomic('ReferenceFrame',RF)
filter = insfilterNonholonomic(___,Name,Value)
```

Description

`filter = insfilterNonholonomic` creates an `insfilterErrorState` object with default property values.

`filter = insfilterNonholonomic('ReferenceFrame',RF)` allows you to specify the reference frame, RF, of the filter. Specify RF as 'NED' (North-East-Down) or 'ENU' (East-North-Up). The default value is 'NED'.

`filter = insfilterNonholonomic(___,Name,Value)` also allows you set properties of the created filter using one or more name-value pairs. Enclose each property name in single quotes.

Properties

IMUSampleRate — Sample rate of the IMU (Hz)

100 (default) | positive scalar

Sample rate of the IMU in Hz, specified as a positive scalar.

Data Types: `single` | `double`

ReferenceLocation — Reference location (deg, deg, meters)

[0 0 0] (default) | 3-element positive row vector

Reference location, specified as a 3-element row vector in geodetic coordinates (latitude, longitude, and altitude). Altitude is the height above the reference ellipsoid model, WGS84. The reference location units are [degrees degrees meters].

Data Types: `single` | `double`

DecimationFactor — Decimation factor for kinematic constraint correction

2 (default) | positive integer scalar

Decimation factor for kinematic constraint correction, specified as a positive integer scalar.

Data Types: single | double

GyroscopeNoise — Multiplicative process noise variance from gyroscope (rad/s)²

[4.8e-6 4.8e-6 4.8e-6] (default) | scalar | 3-element row vector

Multiplicative process noise variance from the gyroscope in (rad/s)², specified as a scalar or 3-element row vector of positive real finite numbers.

- If **GyroscopeNoise** is specified as a row vector, the elements correspond to the noise in the x, y, and z axes of the gyroscope, respectively.
- If **GyroscopeNoise** is specified as a scalar, the single element is applied to the x, y, and z axes of the gyroscope.

Data Types: single | double

GyroscopeBiasNoise — Multiplicative process noise variance from gyroscope bias (rad/s)²

[4e-14 4e-14 4e-14] (default) | scalar | 3-element row vector

Multiplicative process noise variance from the gyroscope bias in (rad/s)², specified as a scalar or 3-element row vector of positive real finite numbers. Gyroscope bias is modeled as a lowpass filtered white noise process.

- If **GyroscopeBiasNoise** is specified as a row vector, the elements correspond to the noise in the x, y, and z axes of the gyroscope, respectively.
- If **GyroscopeBiasNoise** is specified as a scalar, the single element is applied to the x, y, and z axes of the gyroscope.

Data Types: single | double

GyroscopeBiasDecayFactor — Decay factor for gyroscope bias

0.999 (default) | scalar in the range [0,1]

Decay factor for gyroscope bias, specified as a scalar in the range [0,1]. A decay factor of 0 models gyroscope bias as a white noise process. A decay factor of 1 models the gyroscope bias as a random walk process.

Data Types: single | double

AccelerometerNoise — Multiplicative process noise variance from accelerometer (m/s²)²

[4.8e-2 4.8e-2 4.8e-2] (default) | scalar | 3-element row vector

Multiplicative process noise variance from the accelerometer in (m/s²)², specified as a scalar or 3-element row vector of positive real finite numbers.

- If **AccelerometerNoise** is specified as a row vector, the elements correspond to the noise in the x, y, and z axes of the accelerometer, respectively.
- If **AccelerometerNoise** is specified as a scalar, the single element is applied to each axis.

Data Types: single | double

AccelerometerBiasNoise — Multiplicative process noise variance from accelerometer bias (m/s²)²

[4e-14 4e-14 4e-14] (default) | positive scalar | 3-element row vector

Multiplicative process noise variance from the accelerometer bias in (m/s²)², specified as a scalar or 3-element row vector of positive real numbers. Accelerometer bias is modeled as a lowpass filtered white noise process.

- If `AccelerometerBiasNoise` is specified as a row vector, the elements correspond to the noise in the *x*, *y*, and *z* axes of the accelerometer, respectively.
- If `AccelerometerBiasNoise` is specified as a scalar, the single element is applied to each axis.

AccelerometerBiasDecayFactor — Decay factor for accelerometer bias

0.9999 (default) | scalar in the range [0,1]

Decay factor for accelerometer bias, specified as a scalar in the range [0,1]. A decay factor of 0 models accelerometer bias as a white noise process. A decay factor of 1 models the accelerometer bias as a random walk process.

Data Types: single | double

State — State vector of extended Kalman filter

[1; zeros(15,1)] | 16-element column vector

State vector of the extended Kalman filter. The state values represent:

State	Units	Index
Orientation (quaternion parts)	N/A	1:4
Gyroscope Bias (XYZ)	rad/s	5:7
Position (NED or ENU)	m	8:10
Velocity (NED or ENU)	m/s	11:13
Accelerometer Bias (XYZ)	m/s ²	14:16

Data Types: single | double

StateCovariance — State error covariance for extended Kalman filter

eye(16) (default) | 16-by-16 matrix

State error covariance for the extended Kalman filter, specified as a 16-by-16-element matrix, or real numbers.

Data Types: single | double

ZeroVelocityConstraintNoise — Velocity constraints noise (m/s)²

1e-2 (default) | nonnegative scalar

Velocity constraints noise in (m/s)², specified as a nonnegative scalar.

Data Types: single | double

Object Functions

`correct` Correct states using direct state measurements for `insfilterNonholonomic`

residual	Residuals and residual covariances from direct state measurements for insfilterNonholonomic
fusegps	Correct states using GPS data for insfilterNonholonomic
residualgps	Residuals and residual covariance from GPS measurements for insfilterNonholonomic
pose	Current orientation and position estimate for insfilterNonholonomic
predict	Update states using accelerometer and gyroscope data for insfilterNonholonomic
reset	Reset internal states for insfilterNonholonomic
stateinfo	Display state vector information for insfilterNonholonomic
tune	Tune insfilterNonholonomic parameters to reduce estimation error
copy	Create copy of insfilterNonholonomic

Examples

Estimate Pose of Ground Vehicle

This example shows how to estimate the pose of a ground vehicle from logged IMU and GPS sensor measurements and ground truth orientation and position.

Load the logged data of a ground vehicle following a circular trajectory.

```
load('loggedGroundVehicleCircle.mat','imuFs','localOrigin','initialState','initialStateCovariance','gyroData','gpsFs','gpsLLA','Rpos','gpsVel','Rvel','trueOrient','truePos');
```

Initialize the insfilterNonholonomic object.

```
filt = insfilterNonholonomic;
filt.IMUSampleRate = imuFs;
filt.ReferenceLocation = localOrigin;
filt.State = initialState;
filt.StateCovariance = initialStateCovariance;
```

```
imuSamplesPerGPS = imuFs/gpsFs;
```

Log data for final metric computation. Use the predict object function to estimate filter state based on accelerometer and gyroscope data. Then correct the filter state according to GPS data.

```
numIMUSamples = size(accelData,1);
estOrient = quaternion.ones(numIMUSamples,1);
estPos = zeros(numIMUSamples,3);

gpsIdx = 1;

for idx = 1:numIMUSamples
    predict(filt,accelData(idx,:),gyroData(idx,:));           %Predict filter state

    if (mod(idx,imuSamplesPerGPS) == 0)                       %Correct filter state
        fusegps(filt,gpsLLA(gpsIdx,:),Rpos,gpsVel(gpsIdx,:),Rvel);
        gpsIdx = gpsIdx + 1;
    end

    [estPos(idx,:),estOrient(idx,:)] = pose(filt);           %Log estimated pose
end
```

Calculate and display RMS errors.

```

posd = estPos - truePos;
quatd = rad2deg(dist(estOrient,trueOrient));
msep = sqrt(mean(posd.^2));

fprintf('Position RMS Error\n\tX: %.2f, Y: %.2f, Z: %.2f (meters)\n\n',msep(1),msep(2),msep(3));

Position RMS Error
  X: 0.15, Y: 0.11, Z: 0.01 (meters)

fprintf('Quaternion Distance RMS Error\n\t%.2f (degrees)\n\n',sqrt(mean(quatd.^2)));

Quaternion Distance RMS Error
  0.26 (degrees)

```

Algorithms

Note: The following algorithm only applies to an NED reference frame.

`insfilterNonholonomic` uses a 16-axis error state Kalman filter structure to estimate pose in the NED reference frame. The state is defined as:

$$\mathbf{x} = \begin{bmatrix} q_0 \\ q_1 \\ q_2 \\ q_3 \\ gyrobias_X \\ gyrobias_Y \\ gyrobias_Z \\ position_N \\ position_E \\ position_D \\ v_N \\ v_E \\ v_D \\ accelbias_X \\ accelbias_Y \\ accelbias_Z \end{bmatrix}$$

where

- q_0, q_1, q_2, q_3 -- Parts of orientation quaternion. The orientation quaternion represents a frame rotation from the platform's current orientation to the local NED coordinate system.
- $gyrobias_X, gyrobias_Y, gyrobias_Z$ -- Bias in the gyroscope reading.
- $position_N, position_E, position_D$ -- Position of the platform in the local NED coordinate system.
- v_N, v_E, v_D -- Velocity of the platform in the local NED coordinate system.

- $accelbias_x, accelbias_y, accelbias_z$ -- Bias in the accelerometer reading.

Given the conventional formulation of the state transition function,

$$x_{k|k-1} = f(\hat{x}_{k-1|k-1})$$

the predicted state estimate is:

$$x_k | k-1 =$$

$$\begin{array}{l}
 \left[\begin{array}{l}
 q_0 + \Delta t * q_1(\text{gyrobias}_X/2 - \text{gyro}_X/2) + \Delta t * q_2 * (\text{gyrobias}_Y/2 - \text{gyro}_Y/2) + \Delta t * q_3 * (\text{gyrobias}_Z/2 - \text{gyro}_Z/2) \\
 q_1 - \Delta t * q_0(\text{gyrobias}_X/2 - \text{gyro}_X/2) + \Delta t * q_3 * (\text{gyrobias}_Y/2 - \text{gyro}_Y/2) - \Delta t * q_2 * (\text{gyrobias}_Z/2 - \text{gyro}_Z/2) \\
 q_2 - \Delta t * q_3(\text{gyrobias}_X/2 - \text{gyro}_X/2) - \Delta t * q_0 * (\text{gyrobias}_Y/2 - \text{gyro}_Y/2) + \Delta t * q_1 * (\text{gyrobias}_Z/2 - \text{gyro}_Z/2) \\
 q_3 + \Delta t * q_2(\text{gyrobias}_X/2 - \text{gyro}_X/2) - \Delta t * q_1 * (\text{gyrobias}_Y/2 - \text{gyro}_Y/2) - \Delta t * q_0 * (\text{gyrobias}_Z/2 - \text{gyro}_Z/2) \\
 \quad - \text{gryobias}_X * (\Delta t * \lambda_{\text{gyro}} - 1) \\
 \quad - \text{gryobias}_Y * (\Delta t * \lambda_{\text{gyro}} - 1) \\
 \quad - \text{gryobias}_Z * (\Delta t * \lambda_{\text{gyro}} - 1) \\
 \quad \text{position}_N + \Delta t * v_N \\
 \quad \text{position}_E + \Delta t * v_E \\
 \quad \text{position}_D + \Delta t * v_D
 \end{array} \right. \\
 v_N + \Delta t * \left[\begin{array}{l}
 q_0 * (q_0 * (\text{accelbias}_X - \text{accel}_X) - q_3 * (\text{accelbias}_Y - \text{accel}_Y) + q_2 * (\text{accelbias}_Z - \text{accel}_Z)) - g_N + \\
 q_2 * (q_1 * (\text{accelbias}_Y - \text{accel}_Y) - q_2 * (\text{accelbias}_X - \text{accel}_X) + q_0 * (\text{accelbias}_Z - \text{accel}_Z)) + \\
 q_1 * (q_1 * (\text{accelbias}_X - \text{accel}_X) + q_2 * (\text{accelbias}_Y - \text{accel}_Y) + q_3 * (\text{accelbias}_Z - \text{accel}_Z)) - \\
 q_3 * (q_3 * (\text{accelbias}_X - \text{accel}_X) + q_0 * (\text{accelbias}_Y - \text{accel}_Y) - q_1 * (\text{accelbias}_Z - \text{accel}_Z))
 \end{array} \right] \\
 v_E + \Delta t * \left[\begin{array}{l}
 q_0 * (q_3 * (\text{accelbias}_X - \text{accel}_X) + q_0 * (\text{accelbias}_Y - \text{accel}_Y) - q_1 * (\text{accelbias}_Z - \text{accel}_Z)) - g_E - \\
 q_1 * (q_1 * (\text{accelbias}_Y - \text{accel}_Y) - q_2 * (\text{accelbias}_X - \text{accel}_X) + q_0 * (\text{accelbias}_Z - \text{accel}_Z)) + \\
 q_2 * (q_1 * (\text{accelbias}_X - \text{accel}_X) + q_2 * (\text{accelbias}_Y - \text{accel}_Y) + q_3 * (\text{accelbias}_Z - \text{accel}_Z)) + \\
 q_3 * (q_3 * (\text{accelbias}_X - \text{accel}_X) - q_0 * (\text{accelbias}_Y - \text{accel}_Y) + q_1 * (\text{accelbias}_Z - \text{accel}_Z))
 \end{array} \right]
 \end{array}$$

where

- Δt -- IMU sample time.
- g_N, g_E, g_D -- Constant gravity vector in the NED frame.
- $accel_x, accel_y, accel_z$ -- Acceleration vector in the body frame.
- λ_{accel} -- Accelerometer bias decay factor.
- λ_{gyro} -- Gyroscope bias decay factor.

References

- [1] Munguía, R. "A GPS-Aided Inertial Navigation System in Direct Configuration." *Journal of applied research and technology*. Vol. 12, Number 4, 2014, pp. 803 - 814.

Extended Capabilities

C/C++ Code Generation

Generate C and C++ code using MATLAB® Coder™.

See Also

`insfilterAsync` | `insfilterErrorState` | `insfilterMARG`

Topics

"Estimate Position and Orientation of a Ground Vehicle"

Introduced in R2018b

accelparams

Accelerometer sensor parameters

Description

The `accelparams` class creates an accelerometer sensor parameters object. You can use this object to model an accelerometer when simulating an IMU with `imuSensor`.

Creation

Syntax

```
params = accelparams
params = accelparams(Name, Value)
```

Description

`params = accelparams` returns an ideal accelerometer sensor parameters object with default values.

`params = accelparams(Name, Value)` configures an accelerometer sensor parameters object properties using one or more Name-Value pair arguments. Name is a property name and Value is the corresponding value. Name must appear inside single quotes (' '). You can specify several name-value pair arguments in any order as (Name1, Value1, . . . , NameN, ValueN). Any unspecified properties take default values.

Properties

MeasurementRange — Maximum sensor reading (m/s²)

`inf` (default) | real positive scalar

Maximum sensor reading in m/s², specified as a real positive scalar.

Data Types: `single` | `double`

Resolution — Resolution of sensor measurements ((m/s²)/LSB)

`0` (default) | real nonnegative scalar

Resolution of sensor measurements in (m/s²)/LSB, specified as a real nonnegative scalar.

Data Types: `single` | `double`

ConstantBias — Constant sensor offset bias (m/s²)

`[0 0 0]` (default) | real scalar | real 3-element row vector

Constant sensor offset bias in m/s², specified as a real scalar or 3-element row vector. Any scalar input is converted into a real 3-element row vector where each element has the input scalar value.

Data Types: `single` | `double`

AxesMisalignment — Sensor axes skew (%)

[0 0 0] (default) | real scalar in the range [0,100] | real 3-element row vector in the range [0,100]

Sensor axes skew in %, specified as a real scalar or 3-element row vector with values ranging from 0 to 100. Any scalar input is converted into a real 3-element row vector where each element has the input scalar value.

Data Types: single | double

NoiseDensity — Power spectral density of sensor noise (m/s²/√Hz)

[0 0 0] (default) | real scalar | real 3-element row vector

Power spectral density of sensor noise in (m/s²/√Hz), specified as a real scalar or 3-element row vector. This property corresponds to the velocity random walk (VRW). Any scalar input is converted into a real 3-element row vector where each element has the input scalar value.

Data Types: single | double

BiasInstability — Instability of the bias offset (m/s²)

[0 0 0] (default) | real scalar | real 3-element row vector

Instability of the bias offset in m/s², specified as a real scalar or 3-element row vector. Any scalar input is converted into a real 3-element row vector where each element has the input scalar value.

Data Types: single | double

RandomWalk — Integrated white noise of sensor ((m/s²)(√Hz))

[0 0 0] (default) | real scalar | real 3-element row vector

Integrated white noise of sensor in (m/s²)(√Hz), specified as a real scalar or 3-element row vector. Any scalar input is converted into a real 3-element row vector where each element has the input scalar value.

Data Types: single | double

TemperatureBias — Sensor bias from temperature ((m/s²)/°C)

[0 0 0] (default) | real scalar | real 3-element row vector

Sensor bias from temperature in (m/s²)/°C, specified as a real scalar or 3-element row vector. Any scalar input is converted into a real 3-element row vector where each element has the input scalar value.

Data Types: single | double

TemperatureScaleFactor — Scale factor error from temperature (%/°C)

[0 0 0] (default) | real scalar in the range [0,100] | real 3-element row vector in the range [0,100]

Scale factor error from temperature in %/°C, specified as a real scalar or real 3-element row vector with values ranging from 0 to 100. Any scalar input is converted into a real 3-element row vector where each element has the input scalar value.

Data Types: single | double

Examples

Generate Accelerometer Data from Stationary Inputs

Generate accelerometer data for an imuSensor object from stationary inputs.

Generate an accelerometer parameter object with a maximum sensor reading of 19.6 m/s^2 and a resolution of $0.598 \text{ (mm/s}^2\text{)}/\text{LSB}$. The constant offset bias is 0.49 m/s^2 . The sensor has a power spectral density of $3920 \text{ (}\mu\text{m/s}^2\text{)}/\sqrt{\text{Hz}}$. The bias from temperature is $0.294 \text{ (m/s}^2\text{)}/^\circ\text{C}$. The scale factor error from temperature is $0.02\%/^\circ\text{C}$. The sensor axes are skewed by 2%.

```
params = accelparams('MeasurementRange',19.6,'Resolution',0.598e-3,'ConstantBias',0.49,'NoiseDen
```

Use a sample rate of 100 Hz spaced out over 1000 samples. Create the imuSensor object using the accelerometer parameter object.

```
Fs = 100;
numSamples = 1000;
t = 0:1/Fs:(numSamples-1)/Fs;

imu = imuSensor('SampleRate', Fs, 'Accelerometer', params);
```

Generate accelerometer data from the imuSensor object.

```
orient = quaternion.ones(numSamples, 1);
acc = zeros(numSamples, 3);
angvel = zeros(numSamples, 3);

accelData = imu(acc, angvel, orient);
```

Plot the resultant accelerometer data.

```
plot(t, accelData)
title('Accelerometer')
xlabel('s')
ylabel('m/s^2')
```

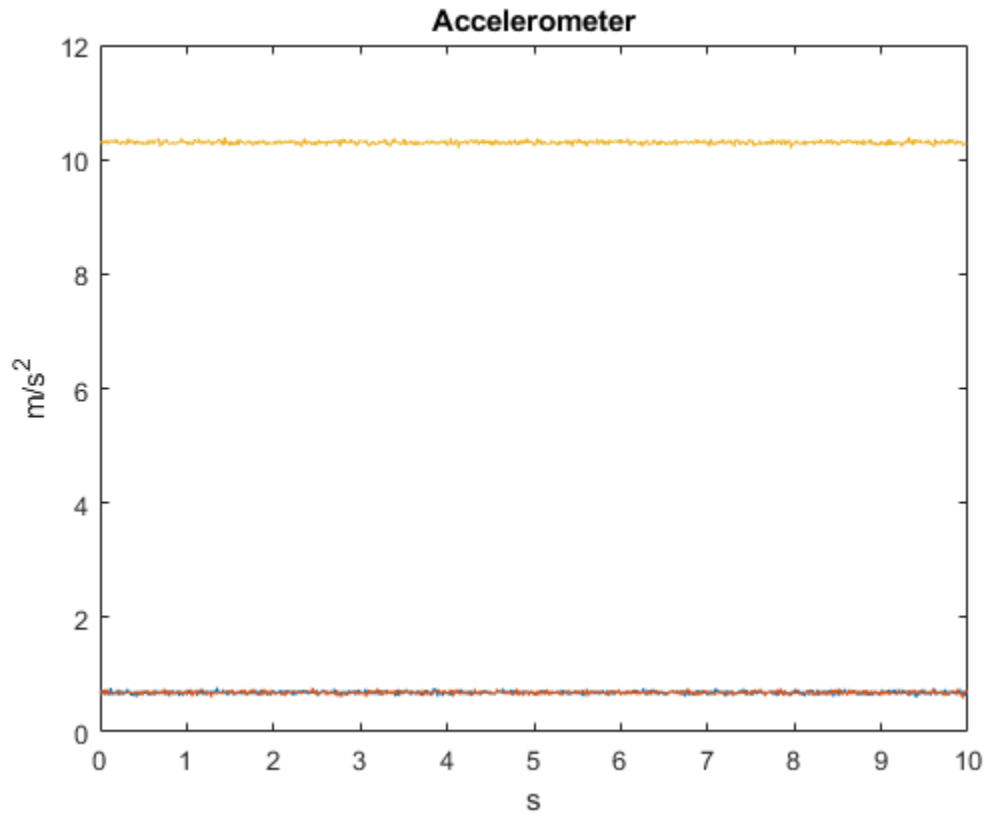

Extended Capabilities

C/C++ Code Generation

Generate C and C++ code using MATLAB® Coder™.

See Also

[gyroparams](#) | [imuSensor](#) | [magparams](#)

Topics

“Model IMU, GPS, and INS/GPS”

Introduced in R2018b

gyroparams

Gyroscope sensor parameters

Description

The `gyroparams` class creates a gyroscope sensor parameters object. You can use this object to model a gyroscope when simulating an IMU with `imuSensor`.

Creation

Syntax

```
params = gyroparams  
params = gyroparams(Name, Value)
```

Description

`params = gyroparams` returns an ideal gyroscope sensor parameters object with default values.

`params = gyroparams(Name, Value)` configures `gyroparams` object properties using one or more `Name, Value` pair arguments. `Name` is a property name and `Value` is the corresponding value. `Name` must appear inside single quotes (`' '`). You can specify several name-value pair arguments in any order as `Name1, Value1, . . . , NameN, ValueN`. Any unspecified properties take default values.

Properties

MeasurementRange — Maximum sensor reading (rad/s)

Inf (default) | real positive scalar

Maximum sensor reading in rad/s, specified as a real positive scalar.

Data Types: `single` | `double`

Resolution — Resolution of sensor measurements ((rad/s)/LSB)

0 (default) | real nonnegative scalar

Resolution of sensor measurements in (rad/s)/LSB, specified as a real nonnegative scalar

Data Types: `single` | `double`

ConstantBias — Constant sensor offset bias (rad/s)

[0 0 0] (default) | real scalar | real 3-element row vector

Constant sensor offset bias in rad/s, specified as a real scalar or 3-element row vector. Any scalar input is converted into a real 3-element row vector where each element has the input scalar value.

Data Types: `single` | `double`

AxesMisalignment — Sensor axes skew (%)

[0 0 0] (default) | real scalar in the range [0,100] | real 3-element row vector in the range [0,100]

Sensor axes skew in %, specified as a real scalar or 3-element row vector with values ranging from 0 to 100. Any scalar input is converted into a real 3-element row vector where each element has the input scalar value.

Data Types: `single` | `double`

NoiseDensity — Power spectral density of sensor noise ((rad/s)/√Hz)

[0 0 0] (default) | real scalar | real 3-element row vector

Power spectral density of sensor noise in (rad/s)/√Hz, specified as a real scalar or 3-element row vector. This property corresponds to the angle random walk (ARW). Any scalar input is converted into a real 3-element row vector where each element has the input scalar value.

Data Types: `single` | `double`

BiasInstability — Instability of the bias offset (rad/s)

[0 0 0] (default) | real scalar | real 3-element row vector

Instability of the bias offset in rad/s, specified as a real scalar or 3-element row vector. Any scalar input is converted into a real 3-element row vector where each element has the input scalar value.

Data Types: `single` | `double`

RandomWalk — Integrated white noise of sensor ((rad/s)(√Hz))

[0 0 0] (default) | real scalar | real 3-element row vector

Integrated white noise of sensor in (rad/s)(√Hz), specified as a real scalar or 3-element row vector. Any scalar input is converted into a real 3-element row vector where each element has the input scalar value.

Data Types: `single` | `double`

TemperatureBias — Sensor bias from temperature ((rad/s)/°C)

[0 0 0] (default) | real scalar | real 3-element row vector

Sensor bias from temperature in ((rad/s)/°C), specified as a real scalar or 3-element row vector. Any scalar input is converted into a real 3-element row vector where each element has the input scalar value.

Data Types: `single` | `double`

TemperatureScaleFactor — Scale factor error from temperature (%/°C)

[0 0 0] (default) | real scalar in the range [0,100] | real 3-element row vector in the range [0,100]

Scale factor error from temperature in (%/°C), specified as a real scalar or 3-element row vector with values ranging from 0 to 100. Any scalar input is converted into a real 3-element row vector where each element has the input scalar value.

Data Types: `single` | `double`

AccelerationBias — Sensor bias from linear acceleration (rad/s)/(m/s²)

[0 0 0] (default) | real scalar | real 3-element row vector

Sensor bias from linear acceleration in (rad/s)/(m/s²), specified as a real scalar or 3-element row vector. Any scalar input is converted into a real 3-element row vector where each element has the input scalar value.

Data Types: `single` | `double`

Examples

Generate Gyroscope Data from Stationary Inputs

Generate gyroscope data for an `imuSensor` object from stationary inputs.

Generate a gyroscope parameter object with a maximum sensor reading of 4.363 rad/s and a resolution of 1.332e-4 (rad/s)/LSB. The constant offset bias is 0.349 rad/s. The sensor has a power spectral density of 8.727e-4 rad/s/√Hz. The bias from temperature is 0.349 rad/s/°C. The bias from temperature is 0.349 (rad/s²)/°C. The scale factor error from temperature is 0.2%/°C. The sensor axes are skewed by 2%. The sensor bias from linear acceleration is 0.178e-3 (rad/s)/(m/s²)

```
params = gyroparams('MeasurementRange',4.363,'Resolution',1.332e-04,'ConstantBias',0.349,'NoiseD
```

Use a sample rate of 100 Hz spaced out over 1000 samples. Create the `imuSensor` object using the gyroscope parameter object.

```
Fs = 100;
numSamples = 1000;
t = 0:1/Fs:(numSamples-1)/Fs;

imu = imuSensor('accel-gyro','SampleRate',Fs,'Gyroscope',params);
```

Generate gyroscope data from the `imuSensor` object.

```
orient = quaternion.ones(numSamples, 1);
acc = zeros(numSamples, 3);
angvel = zeros(numSamples, 3);
```

```
[~, gyroData] = imu(acc, angvel, orient);
```

Plot the resultant gyroscope data.

```
plot(t, gyroData)
title('Gyroscope')
xlabel('s')
ylabel('rad/s')
```

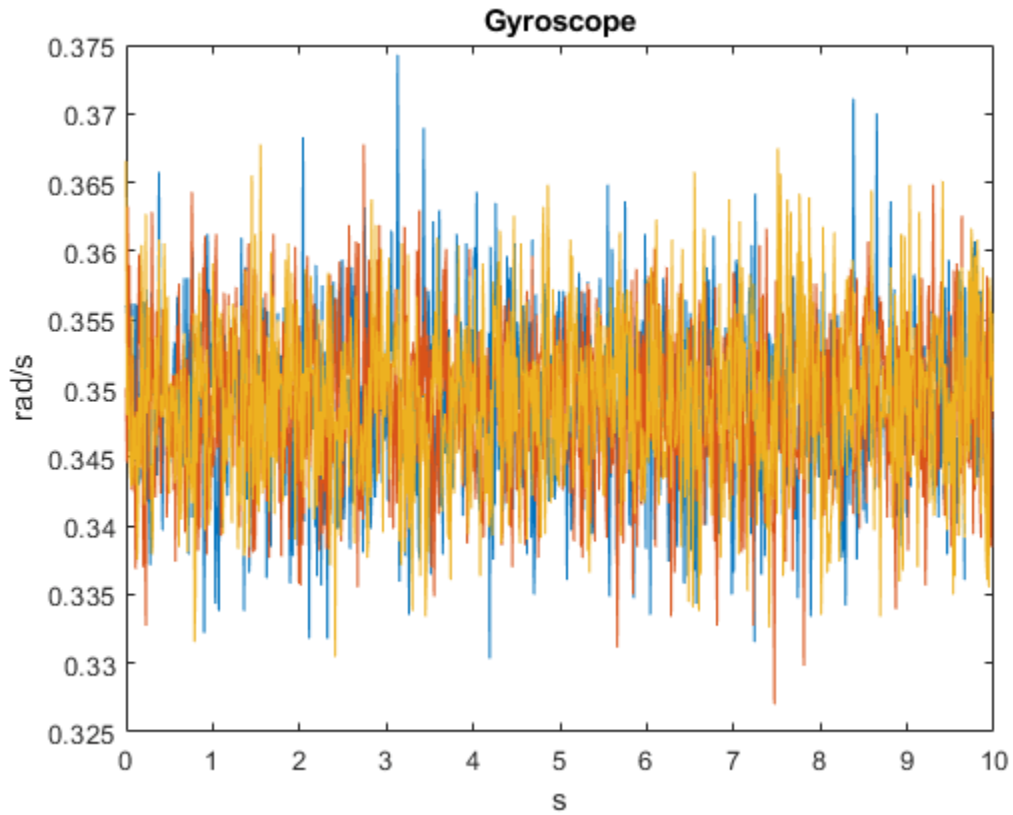

Extended Capabilities

C/C++ Code Generation

Generate C and C++ code using MATLAB® Coder™.

See Also

[accelparams](#) | [imuSensor](#) | [magparams](#)

Topics

“Model IMU, GPS, and INS/GPS”

Introduced in R2018b

magparams

Magnetometer sensor parameters

Description

The `magparams` class creates a magnetometer sensor parameters object. You can use this object to model a magnetometer when simulating an IMU with `imuSensor`.

Creation

Syntax

```
params = magarams  
params = magparams(Name, Value)
```

Description

`params = magarams` returns an ideal magnetometer sensor parameters object with default values.

`params = magparams(Name, Value)` configures `magparams` object properties using one or more `Name, Value` pair arguments. `Name` is a property name and `Value` is the corresponding value. `Name` must appear inside single quotes (`'`). You can specify several name-value pair arguments in any order as `Name1, Value1, . . . , NameN, ValueN`. Any unspecified properties take default values.

Properties

MeasurementRange — Maximum sensor reading (μT)

`Inf` (default) | real positive scalar

Maximum sensor reading in μT , specified as a real positive scalar.

Data Types: `single` | `double`

Resolution — Resolution of sensor measurements ($\mu\text{T}/\text{LSB}$)

`0` (default) | real nonnegative scalar

Resolution of sensor measurements in $\mu\text{T}/\text{LSB}$, specified as a real nonnegative scalar

Data Types: `single` | `double`

ConstantBias — Constant sensor offset bias (μT)

`[0 0 0]` (default) | real scalar | real 3-element row vector

Constant sensor offset bias in μT , specified as a real scalar or 3-element row vector. Any scalar input is converted into a real 3-element row vector where each element has the input scalar value.

Data Types: `single` | `double`

AxesMisalignment — Sensor axes skew (%)

[0 0 0] (default) | real scalar in the range [0,100] | real 3-element row vector in the range [0,100]

Sensor axes skew in %, specified as a real scalar or 3-element row vector with values ranging from 0 to 100. Any scalar input is converted into a real 3-element row vector where each element has the input scalar value.

Data Types: single | double

NoiseDensity — Power spectral density of sensor noise ($\mu\text{T}/\sqrt{\text{Hz}}$)

[0 0 0] (default) | real scalar | real 3-element row vector

Power spectral density of sensor noise in $\mu\text{T}/\sqrt{\text{Hz}}$, specified as a real scalar or 3-element row vector. Any scalar input is converted into a real 3-element row vector where each element has the input scalar value.

Data Types: single | double

BiasInstability — Instability of the bias offset (μT)

[0 0 0] (default) | real scalar | real 3-element row vector

Instability of the bias offset in μT , specified as a real scalar or 3-element row vector. Any scalar input is converted into a real 3-element row vector where each element has the input scalar value.

Data Types: single | double

RandomWalk — Integrated white noise of sensor ($\mu\text{T}/\sqrt{\text{Hz}}$)

[0 0 0] (default) | real scalar | real 3-element row vector

Integrated white noise of sensor in ($\mu\text{T}/\sqrt{\text{Hz}}$), specified as a real scalar or 3-element row vector. Any scalar input is converted into a real 3-element row vector where each element has the input scalar value.

Data Types: single | double

TemperatureBias — Sensor bias from temperature ($\mu\text{T}/^\circ\text{C}$)

[0 0 0] (default) | real scalar | real 3-element row vector

Sensor bias from temperature in ($\mu\text{T}/^\circ\text{C}$), specified as a real scalar or 3-element row vector. Any scalar input is converted into a real 3-element row vector where each element has the input scalar value.

Data Types: single | double

TemperatureScaleFactor — Scale factor error from temperature ($\%/^\circ\text{C}$)

[0 0 0] (default) | real scalar in the range [0,100] | real 3-element row vector in the range [0,100]

Scale factor error from temperature in ($\%/^\circ\text{C}$), specified as a real scalar or 3-element row vector with values ranging from 0 to 100. Any scalar input is converted into a real 3-element row vector where each element has the input scalar value.

Data Types: single | double

Examples

Generate Magnetometer Data from Stationary Inputs

Generate magnetometer data for an imuSensor object from stationary inputs.

Generate a magnetometer parameter object with a maximum sensor reading of 1200 μT and a resolution of 0.1 $\mu\text{T}/\text{LSB}$. The constant offset bias is 1 μT . The sensor has a power spectral density of $\left(\frac{[0.6 \ 0.6 \ 0.9]}{\sqrt{100}}\right) \mu\text{T}/\sqrt{\text{Hz}}$. The bias from temperature is [0.8 0.8 2.4] $\mu\text{T}/^\circ\text{C}$. The scale factor error from temperature is 0.1 %/°C.

```
params = magparams('MeasurementRange',1200,'Resolution',0.1,'ConstantBias',1,'NoiseDensity',[0.6
```

Use a sample rate of 100 Hz spaced out over 1000 samples. Create the imuSensor object using the magnetometer parameter object.

```
Fs = 100;
numSamples = 1000;
t = 0:1/Fs:(numSamples-1)/Fs;
```

```
imu = imuSensor('accel-mag','SampleRate',Fs,'Magnetometer',params);
```

Generate magnetometer data from the imuSensor object.

```
orient = quaternion.ones(numSamples, 1);
acc = zeros(numSamples, 3);
angvel = zeros(numSamples, 3);
```

```
[~, magData] = imu(acc, angvel, orient);
```

Plot the resultant magnetometer data.

```
plot(t, magData)
title('Magnetometer')
xlabel('s')
ylabel('\mu T')
```

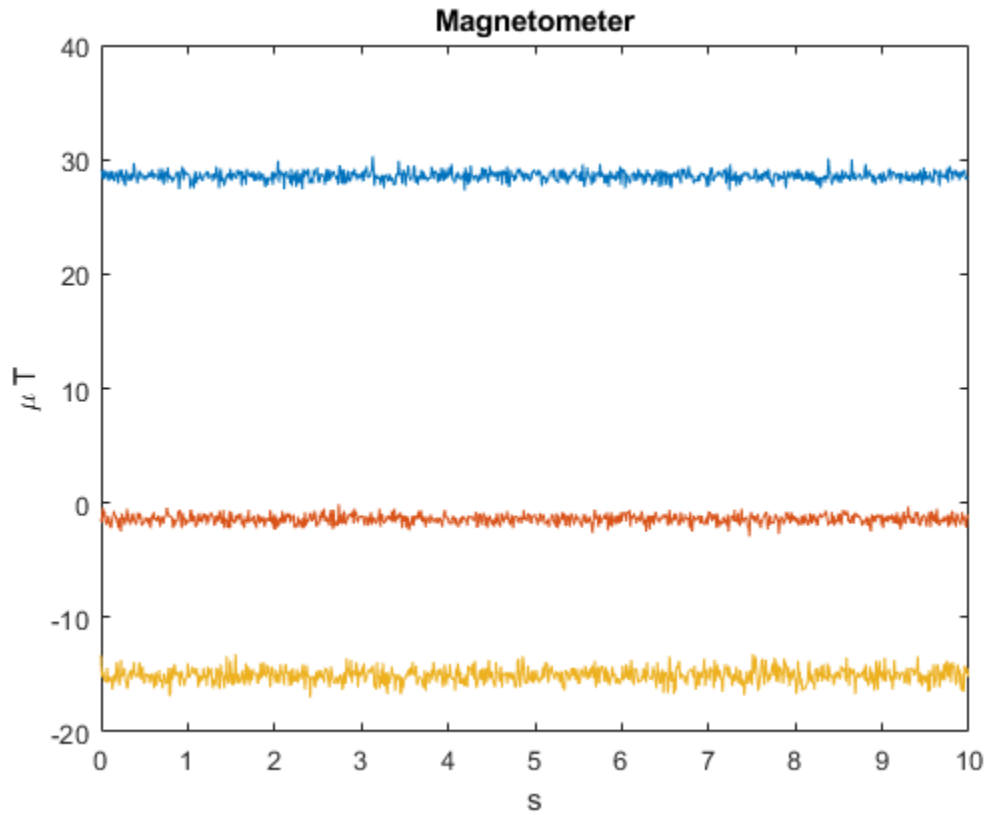

Extended Capabilities

C/C++ Code Generation

Generate C and C++ code using MATLAB® Coder™.

See Also

[accelparams](#) | [gyroparams](#) | [imuSensor](#)

Topics

“Model IMU, GPS, and INS/GPS”

Introduced in R2018b

objectDetection

Report for single object detection

Description

An `objectDetection` object contains an object detection report that was obtained by a sensor for a single object. You can use the `objectDetection` output as the input to trackers.

Creation

Syntax

```
detection = objectDetection(time,measurement)
detection = objectDetection( ____,Name,Value)
```

Description

`detection = objectDetection(time,measurement)` creates an object detection at the specified time from the specified measurement.

`detection = objectDetection(____,Name,Value)` creates a detection object with properties specified as one or more `Name,Value` pair arguments. Any unspecified properties have default values. You cannot specify the `Time` or `Measurement` properties using `Name,Value` pairs.

Input Arguments

time — Detection time

nonnegative real scalar

Detection time, specified as a nonnegative real scalar. This argument sets the `Time` property.

measurement — Object measurement

real-valued N -element vector

Object measurement, specified as a real-valued N -element vector. N is determined by the coordinate system used to report detections and other parameters that you specify in the `MeasurementParameters` property for the `objectDetection` object.

This argument sets the `Measurement` property.

Output Arguments

detection — Detection report

`objectDetection` object

Detection report for a single object, returned as an `objectDetection` object. An `objectDetection` object contains these properties:

Property	Definition
Time	Measurement time
Measurement	Object measurements
MeasurementNoise	Measurement noise covariance matrix
SensorIndex	Unique ID of the sensor
ObjectClassID	Object classification
ObjectAttributes	Additional information passed to tracker
MeasurementParameters	Parameters used by initialization functions of nonlinear Kalman tracking filters

Properties

Time — Detection time

nonnegative real scalar

Detection time, specified as a nonnegative real scalar. You cannot set this property as a name-value pair. Use the `time` input argument instead.

Example: 5.0

Data Types: double

Measurement — Object measurement

real-valued N -element vector

Object measurement, specified as a real-valued N -element vector. You cannot set this property as a name-value pair. Use the `measurement` input argument instead.

Example: [1.0; -3.4]

Data Types: double | single

MeasurementNoise — Measurement noise covariance

scalar | real positive semi-definite symmetric N -by- N matrix

Measurement noise covariance, specified as a scalar or a real positive semi-definite symmetric N -by- N matrix. N is the number of elements in the measurement vector. For the scalar case, the matrix is a square diagonal N -by- N matrix having the same data interpretation as the measurement.

Example: [5.0, 1.0; 1.0, 10.0]

Data Types: double | single

SensorIndex — Sensor identifier

1 | positive integer

Sensor identifier, specified as a positive integer. The sensor identifier lets you distinguish between different sensors and must be unique to the sensor.

Example: 5

Data Types: double

ObjectClassID — Object class identifier

0 (default) | positive integer

Object class identifier, specified as a positive integer. Object class identifiers distinguish between different kinds of objects. The value 0 denotes an unknown object type. If the class identifier is nonzero, the trackers immediately create a confirmed track from the detection.

Example: 1

Data Types: double

MeasurementParameters — Measurement function parameters

{ } (default) | structure array | cell containing structure array | cell array

Measurement function parameters, specified as a structure array, a cell containing a structure array, or a cell array. The property contains all the arguments used by the measurement function specified by the `MeasurementFcn` property of a nonlinear tracking filter such as `trackingEKF` or `trackingUKF`.

The table shows sample fields for the `MeasurementParameters` structures.

Field	Description	Example
Frame	Frame used to report measurements, specified as one of these values: <ul style="list-style-type: none"> 'rectangular' — Detections are reported in rectangular coordinates. 'spherical' — Detections are reported in spherical coordinates. 	'spherical'
OriginPosition	Position offset of the origin of the frame relative to the parent frame, specified as an [x y z] real-valued vector.	[0 0 0]
OriginVelocity	Velocity offset of the origin of the frame relative to the parent frame, specified as a [vx vy vz] real-valued vector.	[0 0 0]
Orientation	Frame rotation matrix, specified as a 3-by-3 real-valued orthonormal matrix.	[1 0 0; 0 1 0; 0 0 1]
HasAzimuth	Logical scalar indicating if azimuth is included in the measurement.	1
HasElevation	Logical scalar indicating if elevation is included in the measurement. For measurements reported in a rectangular frame, and if <code>HasElevation</code> is false, the reported measurements assume 0 degrees of elevation.	1

Field	Description	Example
HasRange	Logical scalar indicating if range is included in the measurement.	1
HasVelocity	Logical scalar indicating if the reported detections include velocity measurements. For measurements reported in the rectangular frame, if HasVelocity is false, the measurements are reported as [x y z]. If HasVelocity is true, measurements are reported as [x y z vx vy vz].	1
IsParentToChild	Logical scalar indicating if Orientation performs a frame rotation from the parent coordinate frame to the child coordinate frame. When IsParentToChild is false, then Orientation performs a frame rotation from the child coordinate frame to the parent coordinate frame.	0

ObjectAttributes – Object attributes

{ } (default) | cell array

Object attributes passed through the tracker, specified as a cell array. These attributes are added to the output of the trackers but not used by the trackers.

Example: {[10,20,50,100], 'radar1'}

Examples

Create Detection from Position Measurement

Create a detection from a position measurement. The detection is made at a timestamp of one second from a position measurement of [100;250;10] in Cartesian coordinates.

```
detection = objectDetection(1,[100;250;10])
```

```
detection =  
    objectDetection with properties:
```

```
        Time: 1  
        Measurement: [3x1 double]  
        MeasurementNoise: [3x3 double]  
        SensorIndex: 1  
        ObjectClassID: 0  
        MeasurementParameters: { }
```

```
ObjectAttributes: {}
```

Create Detection With Measurement Noise

Create an `objectDetection` from a time and position measurement. The detection is made at a time of one second for an object position measurement of `[100;250;10]`. Add measurement noise and set other properties using Name-Value pairs.

```
detection = objectDetection(1,[100;250;10],'MeasurementNoise',10, ...
    'SensorIndex',1,'ObjectAttributes',{'Example object',5})
```

```
detection =
  objectDetection with properties:
        Time: 1
      Measurement: [3x1 double]
    MeasurementNoise: [3x3 double]
      SensorIndex: 1
      ObjectClassID: 0
    MeasurementParameters: {}
      ObjectAttributes: {'Example object' [5]}
```

Extended Capabilities

C/C++ Code Generation

Generate C and C++ code using MATLAB® Coder™.

See Also

Objects

`fusionRadarSensor` | `irSensor` | `sonarSensor` | `trackerGNN` | `trackerJPDA` | `trackerPHD` | `trackerTOMHT` | `trackingABF` | `trackingCKF` | `trackingEKF` | `trackingGSF` | `trackingIMM` | `trackingKF` | `trackingMSCEKF` | `trackingPF` | `trackingUKF`

Introduced in R2018b

objectTrack

Single object track report

Description

objectTrack captures the track information of a single object. objectTrack is the standard output format for trackers.

Creation

Syntax

```
track = objectTrack  
track = objectTrack(Name, Value)
```

Description

track = objectTrack creates an objectTrack object with default property values. An objectTrack object contains information like the age and state of a single track.

track = objectTrack(Name, Value) allows you to set properties using one or more name-value pairs. Enclose each property name in single quotes.

Properties

TrackID — Unique track identifier

1 (default) | nonnegative integer

Unique track identifier, specified as a nonnegative integer. This property distinguishes different tracks.

Example: 2

BranchID — Unique track branch identifier

0 (default) | nonnegative integer

Unique track branch identifier, specified as a nonnegative integer. This property distinguishes different track branches.

Example: 1

SourceIndex — Index of source track reporting system

1 (default) | nonnegative integer

Index of source track reporting system, specified as a nonnegative integer. This property identifies the source that reports the track.

Example: 3

UpdateTime — Update time of track

0 (default) | nonnegative real scalar

Time at which the track was updated by a tracker, specified as a nonnegative real scalar.

Example: 1.2

Data Types: single | double

Age — Number of times track was updated

1 (default) | positive integer

Number of times the track was updated, specified as a positive integer. When a track is initialized, its Age is equal to 1. Any subsequent update with a hit or miss increases the track Age by 1.

Example: 2

State — Current state of trackzeros(6,1) (default) | real-valued N -element vector

The current state of the track at the UpdateTime, specified as a real-valued N -element vector, where N is the dimension of the state. The format of track state depends on the model used to track the object. For example, for 3-D constant velocity model used with `constvel`, the state vector is $[x; v_x; y; v_y; z; v_z]$.

Example: [1 0.2 3 0.2]

Data Types: single | double

StateCovariance — Current state uncertainty covariance of trackeye(6,6) (default) | real positive semidefinite symmetric N -by- N matrix

The current state uncertainty covariance of the track, specified as a real positive semidefinite symmetric N -by- N matrix, where N is the dimension of state specified in the State property.

Data Types: single | double

StateParameters — Parameters of the track state reference frame

struct() (default) | structure | structure array

Parameters of the track state reference frame, specified as a structure or a structure array. Use this property to define the track state reference frame and how to transform the track from the source coordinate system to the fuser coordinate system.

ObjectClassID — Object class identifier

0 (default) | nonnegative integer

Object class identifier, specified as a nonnegative integer. This property distinguishes between different user-defined types of objects. For example, you can use 1 for objects of type "car", and 2 for objects of type "pedestrian". 0 is reserved for unknown classification.

Example: 3

TrackLogic — Track confirmation and deletion logic type

'History' (default) | 'Integrated' | 'Score'

Confirmation and deletion logic type, specified as:

- 'History' - Track confirmation and deletion is based on the number of times the track has been assigned to a detection in the latest tracker updates.
- 'Score' - Track confirmation and deletion is based on a log-likelihood track score. A high score means that the track is more likely to be valid. A low score means that the track is more likely to be a false alarm.
- 'Integrated' - Track confirmation and deletion is based on the integrated probability of track existence.

TrackLogicState — State of track logic

1-by- M logical vector | 1-by-2 real-valued vector | nonnegative scalar

The current state of the track logic type. Based on the logic type specified in the `TrackLogic` property, the logic state is specified as:

- 'History' - A 1-by- M logical vector, where M is the number of latest track logical states recorded. `true` (1) values indicate hits, and `false` (0) values indicate misses. For example, `[1 0 1 1 1]` represents four hits and one miss in the last five updates. The default value for logic state is 1.
- 'Score' - A 1-by-2 real-valued vector, `[cs, ms]`. `cs` is the current score, and `ms` is the maximum score. The default value is `[0, 0]`.
- 'Integrated' - A nonnegative scalar. The scalar represents the integrated probability of existence of the track. The default value is 0.5.

IsConfirmed — Indicate if track is confirmed

`true` (default) | `false`

Indicate if the track is confirmed, specified as `true` or `false`.

Data Types: `logical`

IsCoasted — Indicate if track is coasted

`false` (default) | `true`

Indicate if the track is coasted, specified as `true` or `false`. A track is coasted if its latest update is based on prediction instead of correction using detections.

Data Types: `logical`

IsSelfReported — Indicate if track is self reported

`true` (default) | `false`

Indicate if the track is self reported, specified as `true` or `false`. A track is self reported if it is reported from internal sources (sensors, trackers, or fusers). To limit the propagation of rumors in a tracking system, use the value `false` if the track was updated by an external source.

Example: `false`

Data Types: `logical`

ObjectAttributes — Object attributes

`struct()` (default) | structure

Object attributes passed by the tracker, specified as a structure.

Object Functions

toStruct Convert objectTrack object to struct

Examples

Create Track Report using objectTrack

Create a report of a track using objectTrack.

```
x = (1:6)';  
P = diag(1:6);  
track = objectTrack('State',x,'StateCovariance',P);  
disp(track)
```

objectTrack with properties:

```
    TrackID: 1  
    BranchID: 0  
    SourceIndex: 1  
    UpdateTime: 0  
    Age: 1  
    State: [6x1 double]  
    StateCovariance: [6x6 double]  
    StateParameters: [1x1 struct]  
    ObjectClassID: 0  
    TrackLogic: 'History'  
    TrackLogicState: 1  
    IsConfirmed: 1  
    IsCoasted: 0  
    IsSelfReported: 1  
    ObjectAttributes: [1x1 struct]
```

Extended Capabilities

C/C++ Code Generation

Generate C and C++ code using MATLAB® Coder™.

- The TrackLogic property can only be set during construction.

See Also

fuserSourceConfiguration | objectDetection | trackFuser

Introduced in R2019b

toStruct

Convert objectTrack object to struct

Syntax

```
S = toStruct(objTrack)
```

Description

`S = toStruct(objTrack)` converts an array of objectTrack objects, `objTrack`, to an array of structures whose fields are equivalent to the properties of `objTrack`.

Examples

Convert objectTrack to Struct

Create a report of a track using objectTrack.

```
x = (1:6)';  
P = diag(1:6);  
track = objectTrack('State', x, 'StateCovariance', P)
```

```
track =  
  objectTrack with properties:  
  
      TrackID: 1  
      BranchID: 0  
      SourceIndex: 1  
      UpdateTime: 0  
      Age: 1  
      State: [6x1 double]  
      StateCovariance: [6x6 double]  
      StateParameters: [1x1 struct]  
      ObjectClassID: 0  
      TrackLogic: 'History'  
      TrackLogicState: 1  
      IsConfirmed: 1  
      IsCoasted: 0  
      IsSelfReported: 1  
      ObjectAttributes: [1x1 struct]
```

Convert the track object to a structure.

```
S = toStruct(track)  
  
S = struct with fields:  
      TrackID: 1  
      BranchID: 0  
      SourceIndex: 1  
      UpdateTime: 0
```



```
    Age: 1
    State: [6x1 double]
StateCovariance: [6x6 double]
StateParameters: [1x1 struct]
    ObjectClassID: 0
    TrackLogic: 'History'
TrackLogicState: 1
    IsConfirmed: 1
    IsCoasted: 0
    IsSelfReported: 1
ObjectAttributes: [1x1 struct]
```

Input Arguments

objTrack — Reports of object track

array of `objectTrack` object

Reports of object tracks, specified as an array of `objectTrack` objects.

Output Arguments

S — Structures converted from `objectTrack`

array of structure

Structures converted from `objectTrack`, returned as an array of structures. The dimension of the returned structure is same with the dimension of the `objTrack` input. The fields of each structure are equivalent to the properties of `objectTrack`.

Extended Capabilities

C/C++ Code Generation

Generate C and C++ code using MATLAB® Coder™.

See Also

`objectTrack`

Introduced in R2019b

quaternion

Create a quaternion array

Description

A quaternion is a four-part hyper-complex number used in three-dimensional rotations and orientations.

A quaternion number is represented in the form $a + bi + cj + dk$, where a , b , c , and d parts are real numbers, and i , j , and k are the basis elements, satisfying the equation: $i^2 = j^2 = k^2 = ijk = -1$.

The set of quaternions, denoted by \mathbf{H} , is defined within a four-dimensional vector space over the real numbers, \mathbf{R}^4 . Every element of \mathbf{H} has a unique representation based on a linear combination of the basis elements, i , j , and k .

All rotations in 3-D can be described by an axis of rotation and angle about that axis. An advantage of quaternions over rotation matrices is that the axis and angle of rotation is easy to interpret. For example, consider a point in \mathbf{R}^3 . To rotate the point, you define an axis of rotation and an angle of rotation.

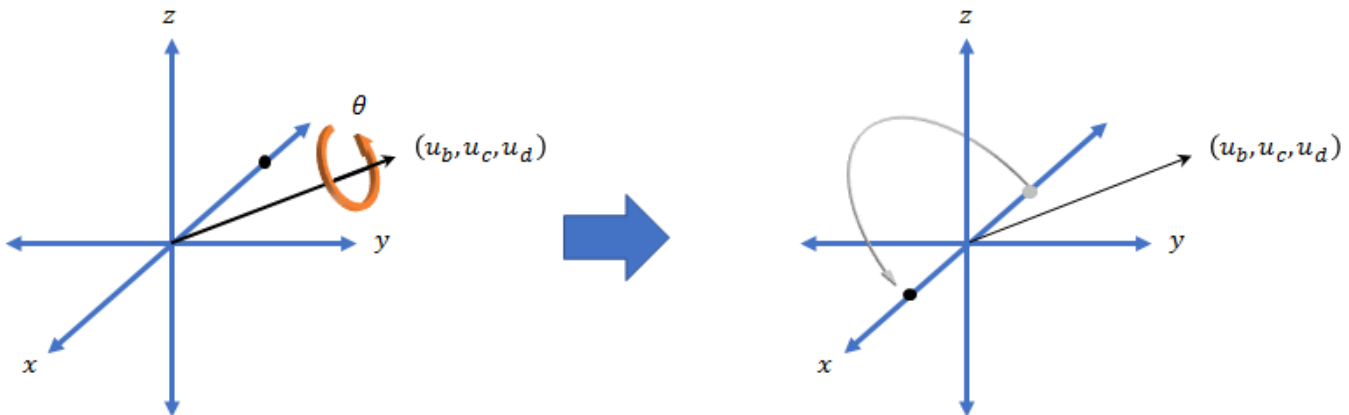

The quaternion representation of the rotation may be expressed as $q = \cos(\theta/2) + \sin(\theta/2)(u_b i + u_c j + u_d k)$, where θ is the angle of rotation and $[u_b, u_c, \text{ and } u_d]$ is the axis of rotation.

Creation

Syntax

```
quat = quaternion()
quat = quaternion(A,B,C,D)
quat = quaternion(matrix)
quat = quaternion(RV, 'rotvec')
```

```

quat = quaternion(RV, 'rotvecd')
quat = quaternion(RM, 'rotmat', PF)
quat = quaternion(E, 'euler', RS, PF)
quat = quaternion(E, 'eulerd', RS, PF)

```

Description

`quat = quaternion()` creates an empty quaternion.

`quat = quaternion(A,B,C,D)` creates a quaternion array where the four quaternion parts are taken from the arrays A, B, C, and D. All the inputs must have the same size and be of the same data type.

`quat = quaternion(matrix)` creates an N -by-1 quaternion array from an N -by-4 matrix, where each column becomes one part of the quaternion.

`quat = quaternion(RV, 'rotvec')` creates an N -by-1 quaternion array from an N -by-3 matrix of rotation vectors, RV. Each row of RV represents a rotation vector in radians.

`quat = quaternion(RV, 'rotvecd')` creates an N -by-1 quaternion array from an N -by-3 matrix of rotation vectors, RV. Each row of RV represents a rotation vector in degrees.

`quat = quaternion(RM, 'rotmat', PF)` creates an N -by-1 quaternion array from the 3-by-3-by- N array of rotation matrices, RM. PF can be either 'point' if the Euler angles represent point rotations or 'frame' for frame rotations.

`quat = quaternion(E, 'euler', RS, PF)` creates an N -by-1 quaternion array from the N -by-3 matrix, E. Each row of E represents a set of Euler angles in radians. The angles in E are rotations about the axes in sequence RS.

`quat = quaternion(E, 'eulerd', RS, PF)` creates an N -by-1 quaternion array from the N -by-3 matrix, E. Each row of E represents a set of Euler angles in degrees. The angles in E are rotations about the axes in sequence RS.

Input Arguments

A, B, C, D — Quaternion parts

comma-separated arrays of the same size

Parts of a quaternion, specified as four comma-separated scalars, matrices, or multi-dimensional arrays of the same size.

Example: `quat = quaternion(1,2,3,4)` creates a quaternion of the form $1 + 2i + 3j + 4k$.

Example: `quat = quaternion([1,5],[2,6],[3,7],[4,8])` creates a 1-by-2 quaternion array where `quat(1,1) = 1 + 2i + 3j + 4k` and `quat(1,2) = 5 + 6i + 7j + 8k`

Data Types: `single` | `double`

matrix — Matrix of quaternion parts

N -by-4 matrix

Matrix of quaternion parts, specified as an N -by-4 matrix. Each row represents a separate quaternion. Each column represents a separate quaternion part.

Example: `quat = quaternion(rand(10,4))` creates a 10-by-1 quaternion array.

Data Types: `single` | `double`

RV — Matrix of rotation vectors

N-by-3 matrix

Matrix of rotation vectors, specified as an *N*-by-3 matrix. Each row of **RV** represents the [X Y Z] elements of a rotation vector. A rotation vector is a unit vector representing the axis of rotation scaled by the angle of rotation in radians or degrees.

To use this syntax, specify the first argument as a matrix of rotation vectors and the second argument as the `'rotvec'` or `'rotvecd'`.

Example: `quat = quaternion(rand(10,3), 'rotvec')` creates a 10-by-1 quaternion array.

Data Types: `single` | `double`

RM — Rotation matrices

3-by-3 matrix | 3-by-3-by-*N* array

Array of rotation matrices, specified by a 3-by-3 matrix or 3-by-3-by-*N* array. Each page of the array represents a separate rotation matrix.

Example: `quat = quaternion(rand(3), 'rotmat', 'point')`

Example: `quat = quaternion(rand(3), 'rotmat', 'frame')`

Data Types: `single` | `double`

PF — Type of rotation matrix

`'point'` | `'frame'`

Type of rotation matrix, specified by `'point'` or `'frame'`.

Example: `quat = quaternion(rand(3), 'rotmat', 'point')`

Example: `quat = quaternion(rand(3), 'rotmat', 'frame')`

Data Types: `char` | `string`

E — Matrix of Euler angles

N-by-3 matrix

Matrix of Euler angles, specified by an *N*-by-3 matrix. If using the `'euler'` syntax, specify *E* in radians. If using the `'eulerd'` syntax, specify *E* in degrees.

Example: `quat = quaternion(E, 'euler', 'YZY', 'point')`

Example: `quat = quaternion(E, 'euler', 'XYZ', 'frame')`

Data Types: `single` | `double`

RS — Rotation sequence

character vector | scalar string

Rotation sequence, specified as a three-element character vector:

- `'YZY'`
- `'YXY'`
- `'ZYZ'`

- 'ZXZ'
- 'XYX'
- 'XZX'
- 'XYZ'
- 'YZX'
- 'ZXY'
- 'XZY'
- 'ZYX'
- 'YXZ'

Assume you want to determine the new coordinates of a point when its coordinate system is rotated using frame rotation. The point is defined in the original coordinate system as:

```
point = [sqrt(2)/2,sqrt(2)/2,0];
```

In this representation, the first column represents the x-axis, the second column represents the y-axis, and the third column represents the z-axis.

You want to rotate the point using the Euler angle representation [45,45,0]. Rotate the point using two different rotation sequences:

- If you create a quaternion rotator and specify the 'ZYX' sequence, the frame is first rotated 45° around the z-axis, then 45° around the new y-axis.

```
quatRotator = quaternion([45,45,0], 'eulerd', 'ZYX', 'frame');
newPointCoordinate = rotateframe(quatRotator,point)
```

```
newPointCoordinate =
    0.7071    -0.0000    0.7071
```

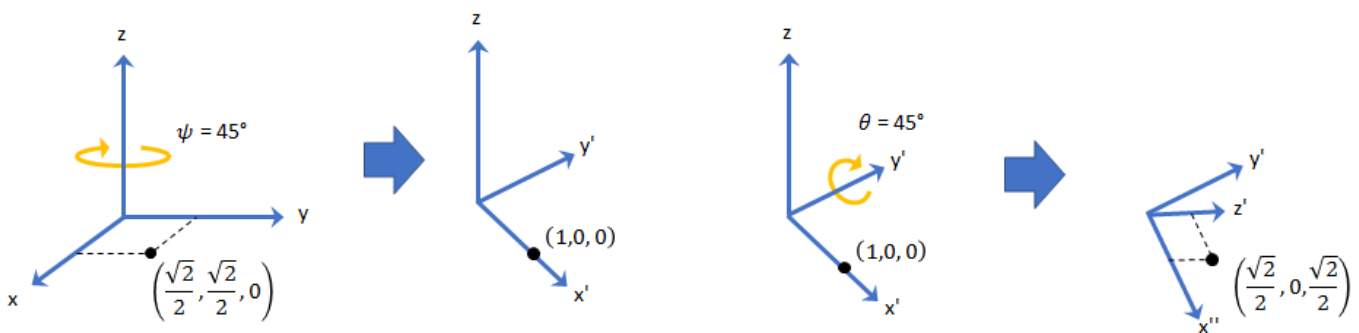

- If you create a quaternion rotator and specify the 'YZX' sequence, the frame is first rotated 45° around the y-axis, then 45° around the new z-axis.

```
quatRotator = quaternion([45,45,0], 'eulerd', 'YZX', 'frame');
newPointCoordinate = rotateframe(quatRotator,point)
```

```
newPointCoordinate =
    0.8536    0.1464    0.5000
```

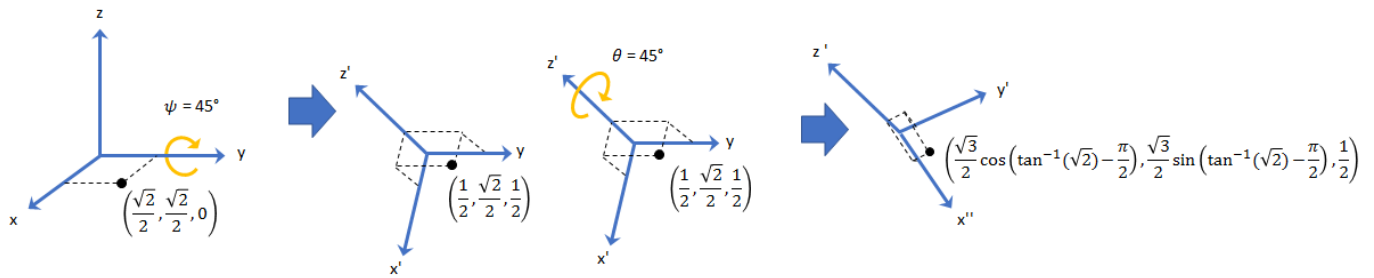

Data Types: char | string

Object Functions

angvel	Angular velocity from quaternion array
classUnderlying	Class of parts within quaternion
compact	Convert quaternion array to N-by-4 matrix
conj	Complex conjugate of quaternion
ctranspose, '	Complex conjugate transpose of quaternion array
dist	Angular distance in radians
euler	Convert quaternion to Euler angles (radians)
eulerd	Convert quaternion to Euler angles (degrees)
exp	Exponential of quaternion array
ldivide, \	Element-wise quaternion left division
log	Natural logarithm of quaternion array
meanrot	Quaternion mean rotation
minus, -	Quaternion subtraction
mtimes, *	Quaternion multiplication
norm	Quaternion norm
normalize	Quaternion normalization
ones	Create quaternion array with real parts set to one and imaginary parts set to zero
parts	Extract quaternion parts
power, .^	Element-wise quaternion power
prod	Product of a quaternion array
randrot	Uniformly distributed random rotations
rdivide, ./	Element-wise quaternion right division
rotateframe	Quaternion frame rotation
rotatepoint	Quaternion point rotation
rotmat	Convert quaternion to rotation matrix
rotvec	Convert quaternion to rotation vector (radians)
rotvecd	Convert quaternion to rotation vector (degrees)
slerp	Spherical linear interpolation
times, .*	Element-wise quaternion multiplication
transpose, '	Transpose a quaternion array
uminus, -	Quaternion unary minus
zeros	Create quaternion array with all parts set to zero

Examples

Create Empty Quaternion

```
quat = quaternion()
```

```
quat =
    0x0 empty quaternion array
```

By default, the underlying class of the quaternion is a double.

```
classUnderlying(quat)
```

```
ans =
    'double'
```

Create Quaternion by Specifying Individual Quaternion Parts

You can create a quaternion array by specifying the four parts as comma-separated scalars, matrices, or multidimensional arrays of the same size.

Define quaternion parts as scalars.

```
A = 1.1;
B = 2.1;
C = 3.1;
D = 4.1;
quatScalar = quaternion(A,B,C,D)

quatScalar = quaternion
    1.1 + 2.1i + 3.1j + 4.1k
```

Define quaternion parts as column vectors.

```
A = [1.1;1.2];
B = [2.1;2.2];
C = [3.1;3.2];
D = [4.1;4.2];
quatVector = quaternion(A,B,C,D)

quatVector=2x1 quaternion array
    1.1 + 2.1i + 3.1j + 4.1k
    1.2 + 2.2i + 3.2j + 4.2k
```

Define quaternion parts as matrices.

```
A = [1.1,1.3; ...
    1.2,1.4];
B = [2.1,2.3; ...
    2.2,2.4];
C = [3.1,3.3; ...
    3.2,3.4];
D = [4.1,4.3; ...
    4.2,4.4];
quatMatrix = quaternion(A,B,C,D)

quatMatrix=2x2 quaternion array
    1.1 + 2.1i + 3.1j + 4.1k    1.3 + 2.3i + 3.3j + 4.3k
    1.2 + 2.2i + 3.2j + 4.2k    1.4 + 2.4i + 3.4j + 4.4k
```

Define quaternion parts as three dimensional arrays.

```

A = randn(2,2,2);
B = zeros(2,2,2);
C = zeros(2,2,2);
D = zeros(2,2,2);
quatMultiDimArray = quaternion(A,B,C,D)

quatMultiDimArray = 2x2x2 quaternion array
quatMultiDimArray(:,:,1) =

    0.53767 +      0i +      0j +      0k   -2.2588 +      0i +      0j +      0k
    1.8339 +      0i +      0j +      0k   0.86217 +      0i +      0j +      0k

quatMultiDimArray(:,:,2) =

    0.31877 +      0i +      0j +      0k   -0.43359 +      0i +      0j +      0k
   -1.3077 +      0i +      0j +      0k   0.34262 +      0i +      0j +      0k

```

Create Quaternion by Specifying Quaternion Parts Matrix

You can create a scalar or column vector of quaternions by specify an N -by-4 matrix of quaternion parts, where columns correspond to the quaternion parts A, B, C, and D.

Create a column vector of random quaternions.

```

quatParts = rand(3,4)

quatParts = 3x4

    0.8147    0.9134    0.2785    0.9649
    0.9058    0.6324    0.5469    0.1576
    0.1270    0.0975    0.9575    0.9706

quat = quaternion(quatParts)

quat=3x1 quaternion array
    0.81472 + 0.91338i + 0.2785j + 0.96489k
    0.90579 + 0.63236i + 0.54688j + 0.15761k
    0.12699 + 0.09754i + 0.95751j + 0.97059k

```

To retrieve the `quatParts` matrix from quaternion representation, use `compact`.

```

retrievedquatParts = compact(quat)

retrievedquatParts = 3x4

    0.8147    0.9134    0.2785    0.9649
    0.9058    0.6324    0.5469    0.1576
    0.1270    0.0975    0.9575    0.9706

```

Create Quaternion by Specifying Rotation Vectors

You can create an N -by-1 quaternion array by specifying an N -by-3 matrix of rotation vectors in radians or degrees. Rotation vectors are compact spatial representations that have a one-to-one relationship with normalized quaternions.

Rotation Vectors in Radians

Create a scalar quaternion using a rotation vector and verify the resulting quaternion is normalized.

```
rotationVector = [0.3491,0.6283,0.3491];
quat = quaternion(rotationVector,'rotvec')

quat = quaternion
    0.92124 + 0.16994i + 0.30586j + 0.16994k

norm(quat)

ans = 1.0000
```

You can convert from quaternions to rotation vectors in radians using the `rotvec` function. Recover the `rotationVector` from the quaternion, `quat`.

```
rotvec(quat)

ans = 1×3
    0.3491    0.6283    0.3491
```

Rotation Vectors in Degrees

Create a scalar quaternion using a rotation vector and verify the resulting quaternion is normalized.

```
rotationVector = [20,36,20];
quat = quaternion(rotationVector,'rotvecd')

quat = quaternion
    0.92125 + 0.16993i + 0.30587j + 0.16993k

norm(quat)

ans = 1
```

You can convert from quaternions to rotation vectors in degrees using the `rotvecd` function. Recover the `rotationVector` from the quaternion, `quat`.

```
rotvecd(quat)

ans = 1×3
    20.0000    36.0000    20.0000
```

Create Quaternion by Specifying Rotation Matrices

You can create an N -by-1 quaternion array by specifying a 3-by-3-by- N array of rotation matrices. Each page of the rotation matrix array corresponds to one element of the quaternion array.

Create a scalar quaternion using a 3-by-3 rotation matrix. Specify whether the rotation matrix should be interpreted as a frame or point rotation.

```
rotationMatrix = [1 0      0; ...
                  0 sqrt(3)/2 0.5; ...
                  0 -0.5    sqrt(3)/2];
quat = quaternion(rotationMatrix, 'rotmat', 'frame')

quat = quaternion
    0.96593 + 0.25882i +      0j +      0k
```

You can convert from quaternions to rotation matrices using the `rotmat` function. Recover the `rotationMatrix` from the quaternion, `quat`.

```
rotmat(quat, 'frame')

ans = 3×3

    1.0000      0      0
         0    0.8660    0.5000
         0   -0.5000    0.8660
```

Create Quaternion by Specifying Euler Angles

You can create an N -by-1 quaternion array by specifying an N -by-3 array of Euler angles in radians or degrees.

Euler Angles in Radians

Use the `euler` syntax to create a scalar quaternion using a 1-by-3 vector of Euler angles in radians. Specify the rotation sequence of the Euler angles and whether the angles represent a frame or point rotation.

```
E = [pi/2,0,pi/4];
quat = quaternion(E, 'euler', 'ZYX', 'frame')

quat = quaternion
    0.65328 + 0.2706i + 0.2706j + 0.65328k
```

You can convert from quaternions to Euler angles using the `euler` function. Recover the Euler angles, `E`, from the quaternion, `quat`.

```
euler(quat, 'ZYX', 'frame')

ans = 1×3

    1.5708      0    0.7854
```

Euler Angles in Degrees

Use the `eulerd` syntax to create a scalar quaternion using a 1-by-3 vector of Euler angles in degrees. Specify the rotation sequence of the Euler angles and whether the angles represent a frame or point rotation.

```
E = [90,0,45];
quat = quaternion(E, 'eulerd', 'ZYX', 'frame')

quat = quaternion
    0.65328 + 0.2706i + 0.2706j + 0.65328k
```

You can convert from quaternions to Euler angles in degrees using the `eulerd` function. Recover the Euler angles, `E`, from the quaternion, `quat`.

```
eulerd(quat, 'ZYX', 'frame')

ans = 1×3
    90.0000         0    45.0000
```

Quaternion Algebra

Quaternions form a noncommutative associative algebra over the real numbers. This example illustrates the rules of quaternion algebra.

Addition and Subtraction

Quaternion addition and subtraction occur part-by-part, and are commutative:

```
Q1 = quaternion(1,2,3,4)

Q1 = quaternion
    1 + 2i + 3j + 4k

Q2 = quaternion(9,8,7,6)

Q2 = quaternion
    9 + 8i + 7j + 6k

Q1plusQ2 = Q1 + Q2

Q1plusQ2 = quaternion
    10 + 10i + 10j + 10k

Q2plusQ1 = Q2 + Q1

Q2plusQ1 = quaternion
    10 + 10i + 10j + 10k

Q1minusQ2 = Q1 - Q2
```

```
Q1minusQ2 = quaternion
-8 - 6i - 4j - 2k
```

```
Q2minusQ1 = Q2 - Q1
```

```
Q2minusQ1 = quaternion
8 + 6i + 4j + 2k
```

You can also perform addition and subtraction of real numbers and quaternions. The first part of a quaternion is referred to as the *real* part, while the second, third, and fourth parts are referred to as the *vector*. Addition and subtraction with real numbers affect only the real part of the quaternion.

```
Q1plusRealNumber = Q1 + 5
```

```
Q1plusRealNumber = quaternion
6 + 2i + 3j + 4k
```

```
Q1minusRealNumber = Q1 - 5
```

```
Q1minusRealNumber = quaternion
-4 + 2i + 3j + 4k
```

Multiplication

Quaternion multiplication is determined by the products of the basis elements and the distributive law. Recall that multiplication of the basis elements, i , j , and k , are not commutative, and therefore quaternion multiplication is not commutative.

```
Q1timesQ2 = Q1 * Q2
```

```
Q1timesQ2 = quaternion
-52 + 16i + 54j + 32k
```

```
Q2timesQ1 = Q2 * Q1
```

```
Q2timesQ1 = quaternion
-52 + 36i + 14j + 52k
```

```
isequal(Q1timesQ2,Q2timesQ1)
```

```
ans = logical
0
```

You can also multiply a quaternion by a real number. If you multiply a quaternion by a real number, each part of the quaternion is multiplied by the real number individually:

```
Q1times5 = Q1*5
```

```
Q1times5 = quaternion
5 + 10i + 15j + 20k
```

Multiplying a quaternion by a real number is commutative.

```
isequal(Q1*5,5*Q1)
```

```
ans = logical
      1
```

Conjugation

The complex conjugate of a quaternion is defined such that each element of the vector portion of the quaternion is negated.

Q1

```
Q1 = quaternion
     1 + 2i + 3j + 4k
```

conj(Q1)

```
ans = quaternion
     1 - 2i - 3j - 4k
```

Multiplication between a quaternion and its conjugate is commutative:

```
isequal(Q1*conj(Q1),conj(Q1)*Q1)
```

```
ans = logical
      1
```

Quaternion Array Manipulation

You can organize quaternions into vectors, matrices, and multidimensional arrays. Built-in MATLAB® functions have been enhanced to work with quaternions.

Concatenate

Quaternions are treated as individual objects during concatenation and follow MATLAB rules for array manipulation.

```
Q1 = quaternion(1,2,3,4);
Q2 = quaternion(9,8,7,6);
```

```
qVector = [Q1,Q2]
```

```
qVector=1x2 quaternion array
     1 + 2i + 3j + 4k     9 + 8i + 7j + 6k
```

```
Q3 = quaternion(-1,-2,-3,-4);
Q4 = quaternion(-9,-8,-7,-6);
```

```
qMatrix = [qVector;Q3,Q4]
```

```
qMatrix=2x2 quaternion array
     1 + 2i + 3j + 4k     9 + 8i + 7j + 6k
```

```
-1 - 2i - 3j - 4k    -9 - 8i - 7j - 6k
```

```
qMultiDimensionalArray(:,:,1) = qMatrix;
qMultiDimensionalArray(:,:,2) = qMatrix
```

```
qMultiDimensionalArray = 2x2x2 quaternion array
qMultiDimensionalArray(:,:,1) =
```

```
1 + 2i + 3j + 4k    9 + 8i + 7j + 6k
-1 - 2i - 3j - 4k   -9 - 8i - 7j - 6k
```

```
qMultiDimensionalArray(:,:,2) =
```

```
1 + 2i + 3j + 4k    9 + 8i + 7j + 6k
-1 - 2i - 3j - 4k   -9 - 8i - 7j - 6k
```

Indexing

To access or assign elements in a quaternion array, use indexing.

```
qLoc2 = qMultiDimensionalArray(2)
```

```
qLoc2 = quaternion
-1 - 2i - 3j - 4k
```

Replace the quaternion at index two with a quaternion one.

```
qMultiDimensionalArray(2) = ones('quaternion')
```

```
qMultiDimensionalArray = 2x2x2 quaternion array
qMultiDimensionalArray(:,:,1) =
```

```
1 + 2i + 3j + 4k    9 + 8i + 7j + 6k
1 + 0i + 0j + 0k   -9 - 8i - 7j - 6k
```

```
qMultiDimensionalArray(:,:,2) =
```

```
1 + 2i + 3j + 4k    9 + 8i + 7j + 6k
-1 - 2i - 3j - 4k   -9 - 8i - 7j - 6k
```

Reshape

To reshape quaternion arrays, use the reshape function.

```
qMatReshaped = reshape(qMatrix,4,1)
```

```
qMatReshaped=4x1 quaternion array
1 + 2i + 3j + 4k
-1 - 2i - 3j - 4k
9 + 8i + 7j + 6k
-9 - 8i - 7j - 6k
```

Transpose

To transpose quaternion vectors and matrices, use the `transpose` function.

```
qMatTransposed = transpose(qMatrix)
```

```
qMatTransposed=2x2 quaternion array
    1 + 2i + 3j + 4k    -1 - 2i - 3j - 4k
    9 + 8i + 7j + 6k    -9 - 8i - 7j - 6k
```

Permute

To permute quaternion vectors, matrices, and multidimensional arrays, use the `permute` function.

```
qMultiDimensionalArray
```

```
qMultiDimensionalArray = 2x2x2 quaternion array
qMultiDimensionalArray(:,:,1) =
```

```
    1 + 2i + 3j + 4k    9 + 8i + 7j + 6k
    1 + 0i + 0j + 0k   -9 - 8i - 7j - 6k
```

```
qMultiDimensionalArray(:,:,2) =
```

```
    1 + 2i + 3j + 4k    9 + 8i + 7j + 6k
   -1 - 2i - 3j - 4k   -9 - 8i - 7j - 6k
```

```
qMatPermute = permute(qMultiDimensionalArray,[3,1,2])
```

```
qMatPermute = 2x2x2 quaternion array
qMatPermute(:,:,1) =
```

```
    1 + 2i + 3j + 4k    1 + 0i + 0j + 0k
    1 + 2i + 3j + 4k   -1 - 2i - 3j - 4k
```

```
qMatPermute(:,:,2) =
```

```
    9 + 8i + 7j + 6k   -9 - 8i - 7j - 6k
    9 + 8i + 7j + 6k   -9 - 8i - 7j - 6k
```

Extended Capabilities

C/C++ Code Generation

Generate C and C++ code using MATLAB® Coder™.

See Also

Topics

“Rotations, Orientation, and Quaternions”

“Lowpass Filter Orientation Using Quaternion SLERP”

Introduced in R2018b

trackingScenario

Create tracking scenario

Description

`trackingScenario` creates a tracking scenario object. A tracking scenario simulates a 3-D arena containing multiple platforms. Platforms represent anything that you want to simulate, such as aircraft, ground vehicles, or ships. Some platforms carry sensors, such as radar, sonar, or infrared. Other platforms act as sources of signals or reflect signals. Platforms can also include stationary obstacles that can influence the motion of other platforms. Platforms can be modeled as points or cuboids by specifying the `'Dimension'` property when calling `platform`. Platforms can have aspect-dependent properties including radar cross-section or sonar target strength. You can populate a tracking scenario by calling the `platform` method for each platform you want to add. Platforms are `Platform` objects. You can create trajectories for any platform using the `kinematicTrajectory`, `waypointTrajectory`, or `geoTrajectory` System objects. After creating the scenario, run the simulation by calling the `advance` object function.

Creation

`sc = trackingScenario` creates an empty tracking scenario with default property values. In this case, you can specify platform trajectories in the scenario as Cartesian states using the `kinematicTrajectory` or `waypointTrajectory` objects.

`sc = trackingScenario('IsEarthCentered', true)` creates an empty Earth-centered tracking scenario with default property values. In this case, you can specify platform trajectories in the scenario as geodetic states using the `geoTrajectory` object.

`sc = trackingScenario(Name, Value)` configures a `trackingScenario` object with properties using one or more `Name, Value` pair arguments. `Name` is a property name and `Value` is the corresponding value. `Name` must appear inside single quotes (`'`). You can specify several name-value pair arguments in any order as `Name1, Value1, . . . , NameN, ValueN`. Any unspecified properties take default values.

Properties

IsEarthCentered — Enable Earth-centered reference frame and trajectories

`false` (default) | `true`

Enable Earth-centered reference frame and trajectories, specified as `true` or `false`.

- If specified as `false`, you must use the `kinematicTrajectory` or `waypointTrajectory` object to define the trajectories of platforms as Cartesian states in the tracking scenario.
- If specified as `true`, you must use the `geoTrajectory` object to define the trajectories of platforms as geodetic coordinates in the tracking scenario. In this case, you must specify the `IsEarthCentered` property during the tracking scenario creation.

Data Types: `logical`

StopTime — Stop time of simulation

Inf (default) | positive scalar

Stop time of simulation, specified as a positive scalar. A simulation stops when either of these conditions is met:

- The stop time is reached.
- Any platform reaches the end of its trajectory and you have specified the platform `Motion` property using waypoints, `waypointTrajectory`.

Units are in seconds.

Example: `60.0`

Data Types: `double`

SimulationTime — Current time of simulation

positive scalar

This property is read-only.

Current time of the simulation, defined as a positive scalar. To reset the simulation time to zero and restart the simulation, call the `restart` method. Units are in seconds.

Data Types: `double`

UpdateRate — Frequency of simulation updates

10.0 (default) | nonnegative scalar

Frequency of simulation updates, specified as a nonnegative scalar in hertz.

- When specified as a positive scalar, the scenario advances with the time step of $1/F$, where F is the value of the `UpdateRate` property.
- When specified as zero, the simulation advances based on the necessity of updating sensors or emitters mounted on platforms of the scenario. Create a platform using the `platform` function.

Example: `2.0`

Data Types: `double`

InitialAdvance — Initial advance when calling advance function

'Zero' (default) | 'UpdateInterval'

Initial advance when calling the advance object function, specified as 'Zero' or 'UpdateInterval'. When specified as

- 'Zero' — The scenario simulation starts at time 0 in the first call of the advance function.
- 'UpdateInterval' — The scenario simulation starts at time $1/F$, where F is the value of a non-zero `UpdateRate` property. If the `UpdateRate` property is specified as 0, the scenario neglects the `InitialAdvance` property and starts at time 0.

Data Types: enumeration

SimulationStatus — Simulation status

NotStarted | InProgress | Completed

This property is read-only.

Simulation status, specified as

- **NotStarted** — When the `advance` object function has not been used on the tracking scenario.
- **InProgress** — When the `advance` object function has been used on the tracking scenario at least once and the scenario has not reached the **Completed** status.
- **Completed** — When the scenario reaches the stop time specified by the `StopTime` property or any `Platform` in the scenario reaches the end of its trajectory.

You can restart a scenario simulation by using the `restart` object function.

Data Types: enumeration

Platforms — Platforms in the simulation

cell | cell array

This property is read-only.

Platforms in the scenario, returned as a cell or cell array of `Platform` objects. To add a platform to the scenario, use the `platform` object function.

Object Functions

<code>platform</code>	Add platform to tracking scenario
<code>advance</code>	Advance tracking scenario simulation by one time step
<code>restart</code>	Restart tracking scenario simulation
<code>record</code>	Run tracking scenario and record platform, sensor, and emitter information
<code>emit</code>	Collect emissions from emitters in tracking scenario
<code>propagate</code>	Propagate emissions in tracking scenario
<code>detect</code>	Collect detections from all the sensors in tracking scenario
<code>lidarDetect</code>	Report point cloud detections from all lidar sensor in trackingScenario
<code>platformPoses</code>	Positions, velocities, and orientations of all platforms in tracking scenario
<code>platformProfiles</code>	Profiles of platforms in tracking scenario
<code>coverageConfig</code>	Sensor and emitter coverage configuration
<code>clone</code>	Create copy of tracking scenario
<code>perturb</code>	Apply perturbations to tracking scenario

Examples

Create Tracking Scenario with Two Platforms

Construct a tracking scenario with two platforms that follow different trajectories.

```
sc = trackingScenario('UpdateRate',100.0, 'StopTime',1.2);
```

Create two platforms.

```
platfm1 = platform(sc);
platfm2 = platform(sc);
```

Platform 1 follows a circular path of radius 10 m for one second. This is accomplished by placing waypoints in a circular shape, ensuring that the first and last waypoint are the same.

```
wpts1 = [0 10 0; 10 0 0; 0 -10 0; -10 0 0; 0 10 0];
time1 = [0; 0.25; .5; .75; 1.0];
platfm1.Trajectory = waypointTrajectory(wpts1, time1);
```

Platform 2 follows a straight path for one second.

```
wpts2 = [-8 -8 0; 10 10 0];
time2 = [0; 1.0];
platfm2.Trajectory = waypointTrajectory(wpts2,time2);
```

Verify the number of platforms in the scenario.

```
disp(sc.Platforms)

    {1×1 fusion.scenario.Platform}    {1×1 fusion.scenario.Platform}
```

Run the simulation and plot the current position of each platform. Use an animated line to plot the position of each platform.

```
figure
grid
axis equal
axis([-12 12 -12 12])
line1 = animatedline('DisplayName','Trajectory 1','Color','b','Marker','.');
line2 = animatedline('DisplayName','Trajectory 2','Color','r','Marker','.');
title('Trajectories')
p1 = pose(platfm1);
p2 = pose(platfm2);
addpoints(line1,p1.Position(1),p1.Position(2));
addpoints(line2,p2.Position(2),p2.Position(2));

while advance(sc)
    p1 = pose(platfm1);
    p2 = pose(platfm2);
    addpoints(line1,p1.Position(1),p1.Position(2));
    addpoints(line2,p2.Position(2),p2.Position(2));
    pause(0.1)
end
```

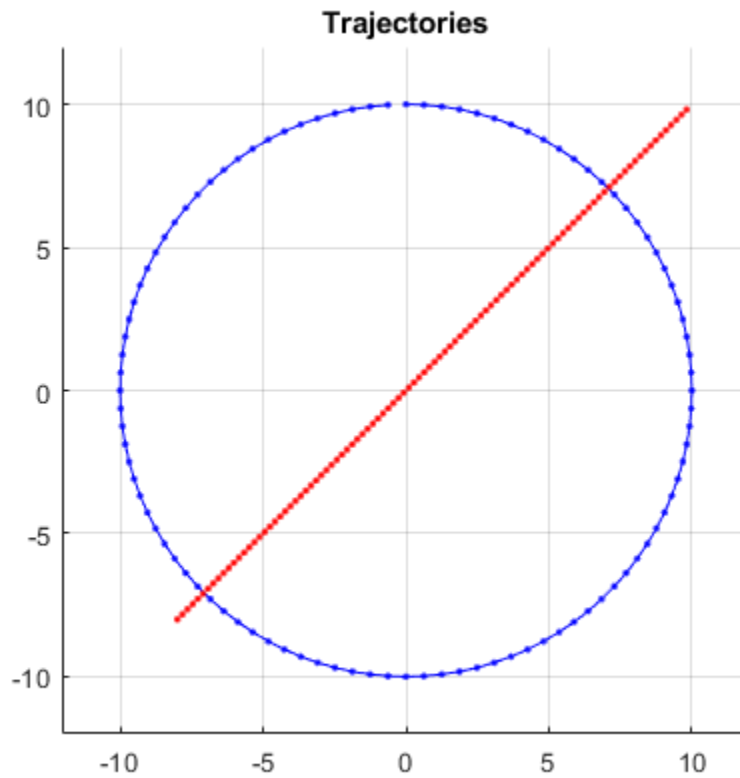

Plot the waypoints for both platforms.

```
hold on
plot(wpts1(:,1),wpts1(:,2),'ob')
text(wpts1(:,1),wpts1(:,2),"t = " + string(time1),'HorizontalAlignment','left','VerticalAlignment','bottom')
plot(wpts2(:,1),wpts2(:,2),'or')
text(wpts2(:,1),wpts2(:,2),"t = " + string(time2),'HorizontalAlignment','left','VerticalAlignment','bottom')
hold off
```

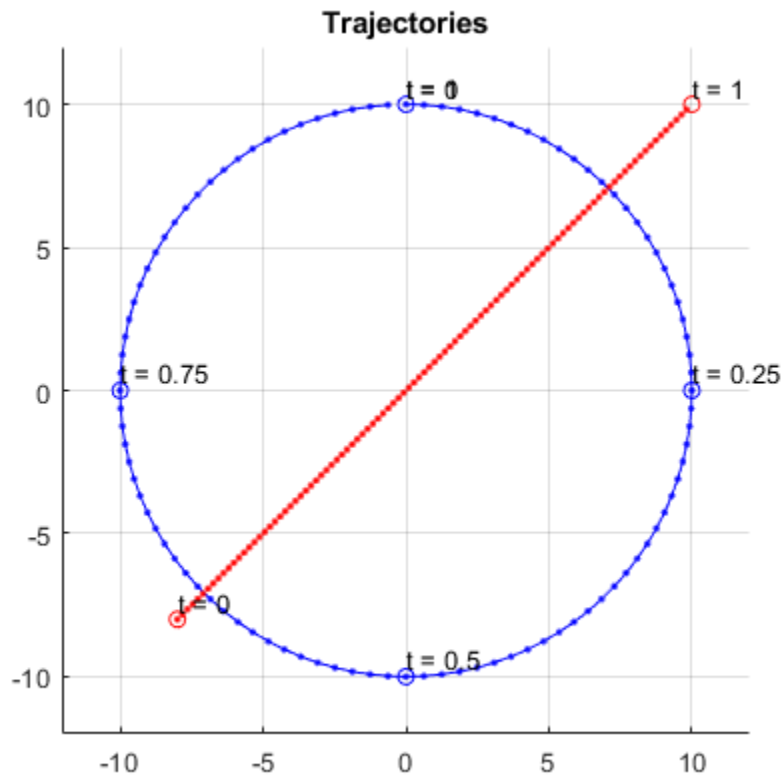

Create Earth Centered Scenario

Create a tracking scenario with a specified update rate.

```
scene = trackingScenario('IsEarthCentered',true,'UpdateRate',0.01);
```

Add an airplane in the scenario. The trajectory of the airplane changes in latitude and altitude.

```
plane = platform(scene,'Trajectory',geoTrajectory([-12.338,-71.349,10600;42.390,-71.349,0],[0 360]));
```

Advance the tracking scenario and record the geodetic and Cartesian positions of the plane target.

```
positions = [];
while advance(scene)
    poseLLA = pose(plane,'CoordinateSystem','Geodetic');
    poseCart = pose(plane,'CoordinateSystem','Cartesian');
    positions = [positions;poseCart.Position];%#ok<AGROW> Allow the buffer to grow.
end
```

Visualize the trajectory in the ECEF frame.

```
figure()
km = 1000;
% Plot the trajectory.
plot3(positions(1,1)/km,positions(1,2)/km,positions(1,3)/km, 'b*');
```

```

hold on;
plot3(positions(end,1)/km,positions(end,2)/km,positions(end,3)/km, 'bo');
plot3(positions(:,1)/km,positions(:,2)/km,positions(:,3)/km,'b');

% Plot the Earth radial lines.
plot3([0 positions(1,1)]/km,[0 positions(1,2)]/km,[0 positions(1,3)]/km,'k:');
plot3([0 positions(end,1)]/km,[0 positions(end,2)]/km,[0 positions(end,3)]/km,'k:');
xlabel('x (km)'); ylabel('y (km)'); zlabel('z (km)');
legend('Start position','End position','Trajectory')

```

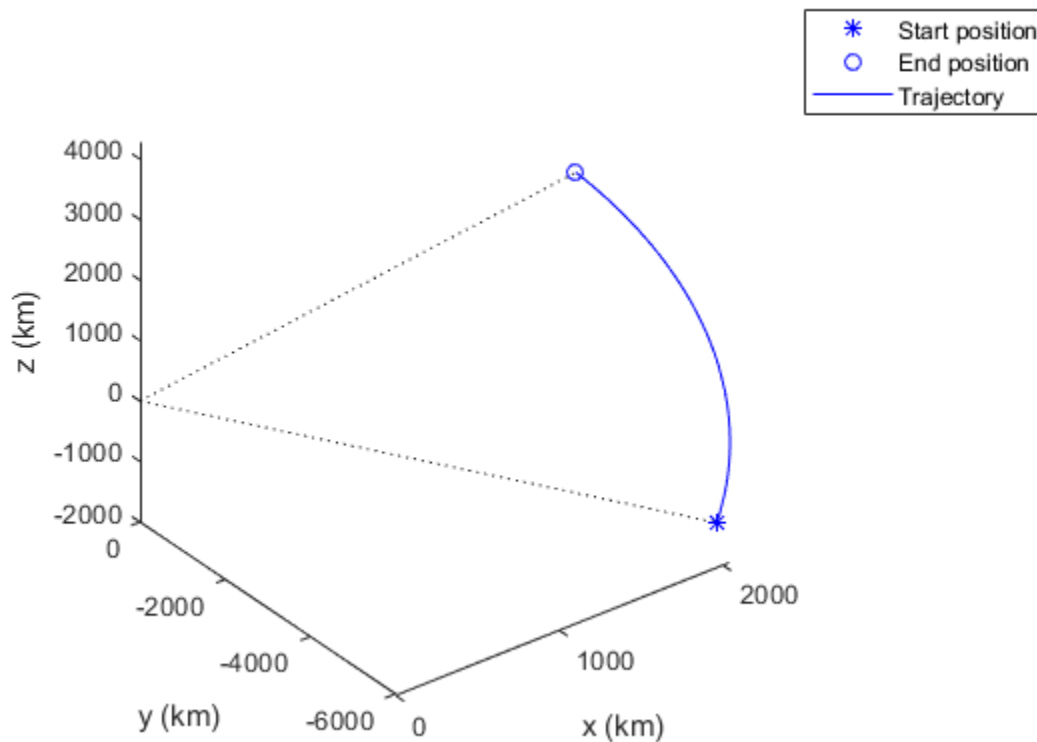

Compatibility Considerations

IsRunning Property Discouraged

Not recommended starting in R2021a

Starting in R2021a, the `IsRunning` property is discouraged. Instead, use the `SimulationStatus` property.

See Also

Objects

`kinematicTrajectory` | `waypointTrajectory`

Introduced in R2018b

Platform

Platform object belonging to tracking scenario

Description

`Platform` defines a platform object belonging to a tracking scenario. Platforms represent the moving objects in a scenario and are modeled as points or cuboids with aspect-dependent properties.

Creation

You can create `Platform` objects using the `platform` method of `trackingScenario`.

Properties

PlatformID — Scenario-defined platform identifier

1 (default) | positive integer

This property is read-only.

Scenario-defined platform identifier, specified as a positive integer. The scenario automatically assigns `PlatformID` values to each platform.

Data Types: `double`

ClassID — Platform classification identifier

0 (default) | nonnegative integer

Platform classification identifier specified as a nonnegative integer. You can define your own platform classification scheme and assign `ClassID` values to platforms according to the scheme. The value of 0 is reserved for an object of unknown or unassigned class.

Example: 5

Data Types: `double` | `single`

Position — Current position of platform

3-element vector of scalar

This property is read-only.

Current position of the platform, specified as a 3-element vector of scalars.

- When the `IsEarthCentered` property of the scenario is set to `false`, the position is expressed as a three element Cartesian state $[x, y, z]$ in meters.
- When the `IsEarthCentered` property of the scenario is set to `true`, the position is expressed as a three element geodetic state: latitude in degrees, longitude in degrees, and altitude in meters.

Data Types: `double`

Orientation – Current orientation of platform

3-element vector of scalar

This property is read-only.

Current orientation of the platform, specified as a 3-element vector of scalars in degrees. The three scalars are the [yaw, pitch, roll] rotation angles from the local reference frame to the platform's body frame.

Data Types: double

Dimensions – Platform dimensions and origin offset

struct

Platform dimensions and origin offset, specified as a structure. The structure contains the Length, Width, Height, and OriginOffset of a cuboid that approximates the dimensions of the platform. The OriginOffset is the position vector from the center of the cuboid to the origin of the platform coordinate frame. The OriginOffset is expressed in the platform coordinate system. For example, if the platform origin is at the center of the cuboid rear face as shown in the following figure, then set OriginOffset as $[-L/2, 0, 0]$. The default value for Dimensions is a structure with all fields set to zero, which corresponds to a point model.

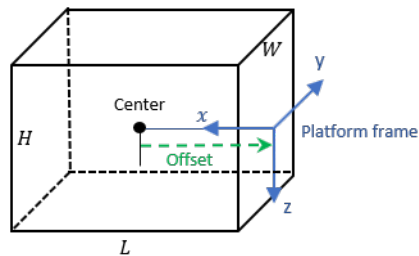
**Fields of Dimensions**

Fields	Description	Default
Length	Dimension of a cuboid along the x direction	0
Width	Dimension of a cuboid along the y direction	0
Height	Dimension of a cuboid along the z direction	0
OriginOffset	Position of the platform coordinate frame origin with respect to the cuboid center	[0 0 0]

Example: `struct('Length',5,'Width',2.5,'Height',3.5,'OriginOffset',[-2.5 0 0])`

Data Types: struct

Trajectory – Platform motion

kinematicTrajectory object | waypointTrajectory object | geoTrajectory object

Platform motion, specified as either a kinematicTrajectory object, a waypointTrajectory object, or a geoTrajectory object. The trajectory object defines the time evolution of the position

and velocity of the platform frame origin, as well as the orientation of the platform frame relative to the scenario frame.

- When the `IsEarthCentered` property of the scenario is set to `false`, you can use the `kinematicTrajectory` or the `waypointTrajectory` object. By default, a stationary `kinematicTrajectory` object is used.
- When the `IsEarthCentered` property of the scenario is set to `true`, you can only use the `geoTrajectory` object. By default, a stationary `geoTrajectory` object is used.

Signatures – Platform signatures

`{rcsSignature irSignature tsSignature}` (default) | cell array of signature objects

Platform signatures, specified as a cell array of `irSignature`, `rcsSignature`, and `tsSignature` objects or an empty cell array. The cell array contains at most only one instance for each type of signature objects listed. A signature represents the reflection or emission pattern of a platform such as its radar cross-section, target strength, or IR intensity.

PoseEstimator – Platform pose-estimator

`insSensor` object (default) | pose estimator object

A pose estimator, specified as a pose-estimator object such as `insSensor`. The pose estimator determines platform pose with respect to the local NED scenario coordinate. The interface of any pose estimator must match the interface of `insSensor`. By default, pose-estimator accuracy properties are set to zero.

Emitters – Emitters mounted on platform

cell array of emitter objects

Emitters mounted on platform, specified as a cell array of emitter objects, such as `radarEmitter` or `sonarEmitter`.

Sensors – Sensors mounted on platform

cell array of sensor objects

Sensors mounted on platform, specified as a cell array of sensor objects such as `irSensor`, `fusionRadarSensor`, `monostaticLidarSensor`, or `sonarSensor`.

Mesh – Mesh of platform

`extendedObjectMesh` object (default)

Mesh of platform, specified as an `extendedObjectMesh` object. The object represents the mesh as vertices and faces. The `monostaticLidarSensor` object uses the platform mesh information to generate cloud data.

Object Functions

<code>detect</code>	Detect signals using platform-mounted sensors
<code>lidarDetect</code>	Report point cloud detections from all lidar sensor on platform
<code>emit</code>	Radiate signals from emitters mounted on platform
<code>pose</code>	Pose of platform
<code>targetPoses</code>	Target positions and orientations as seen from platform
<code>targetMeshes</code>	Target meshes as seen from platform

Examples

Platform Follows Circular Trajectory

Create a tracking scenario and a platform following a circular path.

```
scene = trackingScenario('UpdateRate',1/50);

% Create a platform
plat = platform(scene);

% Follow a circular trajectory 1 km in radius completing in 400 hundred seconds.
plat.Trajectory = waypointTrajectory('Waypoints', [0 1000 0; 1000 0 0; 0 -1000 0; -1000 0 0; 0 1000 0];
    'TimeOfArrival', [0; 100; 200; 300; 400]);

% Perform the simulation
while scene.advance
    p = pose(plat);
    fprintf('Time = %f ', scene.SimulationTime);
    fprintf('Position = [');
    fprintf('%f ', p.Position);
    fprintf('] Velocity = [');
    fprintf('%f ', p.Velocity);
    fprintf(']\n');
end

Time = 0.000000
Position = [
0.000000 1000.000000 0.000000
] Velocity = [
15.707701 -0.000493 0.000000
]
Time = 50.000000
Position = [
707.095476 707.100019 0.000000
] Velocity = [
11.107152 -11.107075 0.000000
]
Time = 100.000000
Position = [
1000.000000 0.000000 0.000000
] Velocity = [
0.000476 -15.707961 0.000000
```

```
]
Time = 150.000000
Position = [
707.115558 -707.115461 0.000000
] Velocity = [
-11.107346 -11.107341 0.000000
]
Time = 200.000000
Position = [
0.000000 -1000.000000 0.000000
] Velocity = [
-15.707963 0.000460 0.000000
]
Time = 250.000000
Position = [
-707.098004 -707.098102 0.000000
] Velocity = [
-11.107069 11.107074 0.000000
]
Time = 300.000000
Position = [
-1000.000000 0.000000 0.000000
] Velocity = [
-0.000476 15.707966 0.000000
]
Time = 350.000000
Position = [
-707.118086 707.113543 0.000000
] Velocity = [
11.107262 11.107340 0.000000
]
Time = 400.000000
```

```

Position = [
-0.000000 1000.000000 0.000000
] Velocity = [
15.708226 -0.000493 0.000000
]

```

Cuboid Platforms Follow Circular Trajectories

Create a tracking scenario with two cuboid platforms following circular trajectories.

```

sc = trackingScenario;

% Create the platform for a truck with dimension 5 x 2.5 x 3.5 (m).
p1 = platform(sc);
p1.Dimensions = struct('Length',5,'Width',2.5,'Height',3.5,'OriginOffset',[0 0 0]);

% Specify the truck's trajectory as a circle with radius 20 meters.
p1.Trajectory = waypointTrajectory('Waypoints', [20*cos(2*pi*(0:10)'/10)...
          20*sin(2*pi*(0:10)'/10) -1.75*ones(11,1)], ...
          'TimeOfArrival', linspace(0,50,11)');

% Create the platform for a small quadcopter with dimension .3 x .3 x .1 (m).
p2 = platform(sc);
p2.Dimensions = struct('Length',.3,'Width',.3,'Height',.1,'OriginOffset',[0 0 0]);

% The quadcopter follows the truck at 10 meters above with small angular delay.
% Note that the negative z coordinates correspond to positive elevation.
p2.Trajectory = waypointTrajectory('Waypoints', [20*cos(2*pi*((0:10)'.6)/10)...
          20*sin(2*pi*((0:10)'.6)/10) -11.80*ones(11,1)], ...
          'TimeOfArrival', linspace(0,50,11)');

```

Visualize the results using theaterPlot.

```

tp = theaterPlot('Xlim',[-30 30],'Ylim',[-30 30],'Zlim',[-12 5]);
pp1 = platformPlotter(tp,'DisplayName','truck','Marker','s');
pp2 = platformPlotter(tp,'DisplayName','quadcopter','Marker','o');

% Specify a view direction and animate.
view(-28,37);
set(gca,'Zdir','reverse');

while advance(sc)
    poses = platformPoses(sc);
    plotPlatform(pp1, poses(1).Position, p1.Dimensions, poses(1).Orientation);
    plotPlatform(pp2, poses(2).Position, p2.Dimensions, poses(2).Orientation);
end

```

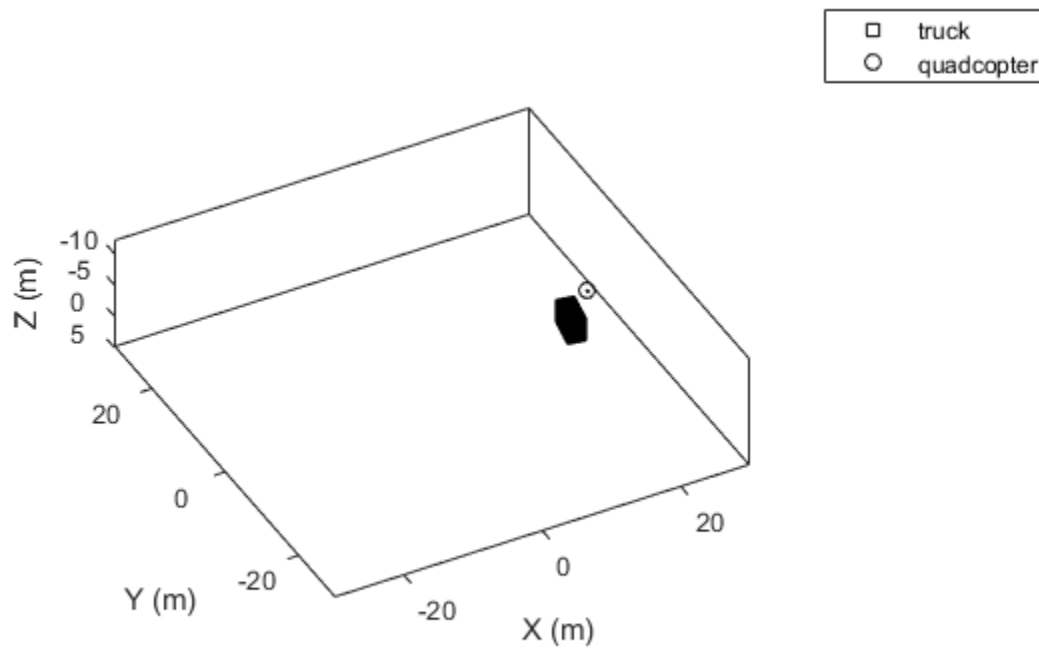

See Also

Classes

[rcsSignature](#) | [tsSignature](#)

Objects

[fusionRadarSensor](#) | [insSensor](#) | [irSensor](#) | [kinematicTrajectory](#) | [monostaticLidarSensor](#) | [radarEmitter](#) | [sonarEmitter](#) | [sonarSensor](#) | [waypointTrajectory](#)

Introduced in R2018b

Platform.emit

Radiate signals from emitters mounted on platform

Syntax

```
[signals,emitterconfigs] = emit(ptfm,time)
```

Description

[signals,emitterconfigs] = emit(ptfm,time) returns signals, signals, radiated by all the emitters mounted on the platform, ptfm, at the specified time. The function also returns all emitter configurations, emitterconfigs.

Input Arguments

ptfm — Scenario platform

Platform object

Scenario platform, specified as a Platform object. To create platforms, use the platform method.

time — Emission time

0 (default) | positive scalar

Emission time, specified as a positive scalar.

Example: 100.5

Data Types: single | double

Output Arguments

signals — Signals radiated by emitters on platform

cell array of emission objects

Signals radiated by emitters on platform, returned as a cell array of radarEmission and sonarEmission objects.

emitterconfigs — Emitter configurations

structure

Emitter configurations, returned as a structure. An emitter configuration has these fields:

Field	Description
EmitterIndex	Unique emitter index, returned as a positive integer.

IsValidTime	Valid emission time, returned as 0 or 1. IsValidTime is 0 when emitter updates are requested at times that are between update intervals specified by the UpdateInterval property.
IsScanDone	Whether the emitter has completed a scan, returned as true or false.
FieldOfView	Field of view of the emitter, returned as a two-element vector [azimuth; elevation] in degrees.
MeasurementParameters	Emitter measurement parameters, returned as an array of structures containing the coordinate frame transforms needed to transform positions and velocities in the top-level frame to the current emitter frame.

Data Types: single | double

See Also

detect | pose | targetPoses

Introduced in R2018b

Platform.detect

Detect signals using platform-mounted sensors

Syntax

```
dets = detect(ptfm,time)
dets = detect(ptfm,signals,time)
dets = detect(ptfm,signals,emitterconfigs,time)
[dets,numDets] = detect(____)
[dets,numDets,sensorconfigs] = detect(____)
```

Description

`dets = detect(ptfm,time)` returns detections, `dets`, from all the sensors mounted on the platform, `ptfm`, at the specified time. This syntax applies when sensors do not require knowledge of any signals present in the scenario, for example, when the `fusionRadarSensor` object property `HasInterference` is set to `false`.

`dets = detect(ptfm,signals,time)` also specifies any signals, `signals`, present in the scenario. This syntax applies when sensors require knowledge of these signals, for example, when a `radarSensor` object is configured as an EM sensor.

`dets = detect(ptfm,signals,emitterconfigs,time)` also specifies emitter configurations, `emitterconfigs`. This syntax applies when sensors require knowledge of the configurations of emitters generating signals in the scenario. For example, when an `fusionRadarSensor` object is configured as a monostatic radar.

`[dets,numDets] = detect(____)` also returns the number of detections, `numDets`. This output syntax can be used with any of the input syntaxes.

`[dets,numDets,sensorconfigs] = detect(____)` also returns all sensor configurations, `sensorconfigs`. This output syntax can be used with any of the input syntaxes.

Input Arguments

ptfm — Scenario platform

Platform object

Scenario platform, specified as a `Platform` object. To create platforms, use the `platform` method.

time — Simulation time

0 (default) | positive scalar

Simulation time specified as a positive scalar.

Example: 1.5

Data Types: `single` | `double`

signals — Signals in scenario

cell array of emission objects

Signals in the scenario, specified as a cell array of `radarEmission` and `sonarEmission` emission objects.

emitterconfigs — Emitter configurations

structure

Emitter configurations, specified as a structure. The fields of the emitter configuration are:

Field	Description
<code>EmitterIndex</code>	Unique emitter index, returned as a positive integer.
<code>IsValidTime</code>	Valid emission time, returned as 0 or 1. <code>IsValidTime</code> is 0 when emitter updates are requested at times that are between update intervals specified by the <code>UpdateInterval</code> property.
<code>IsScanDone</code>	Whether the emitter has completed a scan, returned as <code>true</code> or <code>false</code> .
<code>FieldOfView</code>	Field of view of the emitter, returned as a two-element vector [azimuth; elevation] in degrees.
<code>MeasurementParameters</code>	Emitter measurement parameters, returned as an array of structures containing the coordinate frame transforms needed to transform positions and velocities in the top-level frame to the current emitter frame.

Data Types: `struct`

Output Arguments

dets — sensor detections

cell array of `objectDetection` objects

Sensor detections, returned as a cell array of `objectDetection` objects.

sensorconfigs — Sensor configurations

structure

Sensor configurations, returned as a structure. The fields of this structure are:

Field	Description
<code>SensorIndex</code>	Unique sensor index, returned as a positive integer.
<code>IsValidTime</code>	Valid detection time, returned as <code>true</code> or <code>false</code> . <code>IsValidTime</code> is <code>false</code> when detection updates are requested between update intervals specified by the update rate.
<code>IsScanDone</code>	<code>IsScanDone</code> is <code>true</code> when the sensor has completed a scan.

FieldOfView	Field of view of the sensor, returned as a 2-by-1 vector of positive real values, [azfov;elfov]. azfov and elfov represent the field of view in azimuth and elevation, respectively.
MeasurementParameters	Sensor measurement parameters, returned as an array of structures containing the coordinate frame transforms needed to transform positions and velocities in the top-level frame to the current sensor frame.

Data Types: struct

numDets — Number of detections

nonnegative integer

Number of detections reported, returned as a nonnegative integer.

Data Types: double

More About

Object Detections

Measurements

This section describes the structure of object detections.

The sensor measures the coordinates of the target. The `Measurement` and `MeasurementNoise` values are reported in the coordinate system specified by the `DetectionCoordinates` property of the sensor.

When the `DetectionCoordinates` property is 'Scenario', 'Body', or 'Sensor_rectangular', the `Measurement` and `MeasurementNoise` values are reported in rectangular coordinates. Velocities are only reported when the range rate property, `HasRangeRate`, is true.

When the `DetectionCoordinates` property is 'Sensor_spherical', the `Measurement` and `MeasurementNoise` values are reported in a spherical coordinate system derived from the sensor rectangular coordinate system. Elevation and range rate are only reported when `HasElevation` and `HasRangeRate` are true.

Measurements are ordered as [azimuth, elevation, range, range rate]. Reporting of elevation and range rate depends on the corresponding `HasElevation` and `HasRangeRate` property values. Angles are in degrees, range is in meters, and range rate is in meters per second.

Measurement Coordinates

DetectionCoordinates	Measurement and Measurement Noise Coordinates		
'Scenario'	Coordinate Dependence on HasRangeRate		
'Body'	HasRangeRate	Coordinates	
'Sensor rectangular'	true	[x; y; z; vx; vy; vz]	
	false	[x; y; z]	
'Sensor spherical'	Coordinate Dependence on HasRangeRate and HasElevation		
	HasRangeRate	HasElevation	Coordinates
	true	true	[az; el; rng; rr]
	true	false	[az; rng; rr]
	false	true	[az; el; rng]
false	false	[az; rng]	

Measurement Parameters

The `MeasurementParameters` property consists of an array of structures that describe a sequence of coordinate transformations from a child frame to a parent frame or the inverse transformations (see "Frame Rotation"). In most cases, the longest required sequence of transformations is Sensor → Platform → Scenario.

If the detections are reported in sensor spherical coordinates and `HasINS` is set to `false`, then the sequence consists only of one transformation from sensor to platform. In the transformation, the `OriginPosition` is same as the `MountingLocation` property of the sensor. The `Orientation` consists of two consecutive rotations. The first rotation, corresponding to the `MountingAngles` property of the sensor, accounts for the rotation from the platform frame (P) to the sensor mounting frame (M). The second rotation, corresponding to the azimuth and elevation angles of the sensor, accounts for the rotation from the sensor mounting frame (M) to the sensor scanning frame (S). In the S frame, the x direction is the boresight direction, and the y direction lies within the x - y plane of the sensor mounting frame (M).

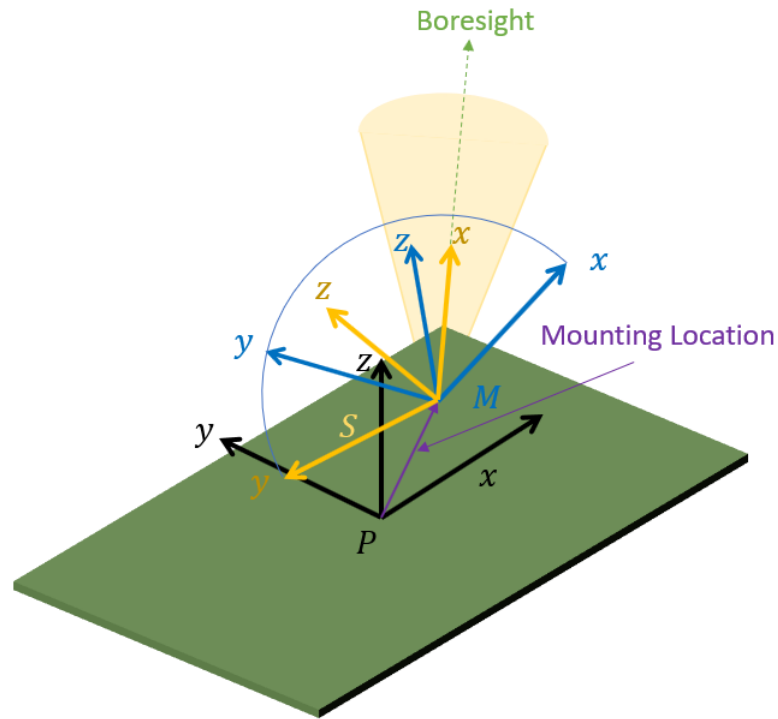

If `HasINS` is `true`, the sequence of transformations consists of two transformations - first from the scenario frame to the platform frame then from platform frame to the sensor scanning frame. In the first transformation, the `Orientation` is the rotation from the scenario frame to the platform frame, and the `OriginPosition` is the position of the platform frame origin relative to the scenario frame.

Trivially, if the detections are reported in platform rectangular coordinates and `HasINS` is set to `false`, the transformation consists only of the identity.

The fields of `MeasurementParameters` are shown here. Not all fields have to be present in the structure. The set of fields and their default values can depend on the type of sensor.

Field	Description
Frame	Enumerated type indicating the frame used to report measurements. When detections are reported using a rectangular coordinate system, Frame is set to 'rectangular'. When detections are reported in spherical coordinates, Frame is set 'spherical' for the first struct.
OriginPosition	Position offset of the origin of the child frame relative to the parent frame, represented as a 3-by-1 vector.
OriginVelocity	Velocity offset of the origin of the child frame relative to the parent frame, represented as a 3-by-1 vector.

Orientation	3-by-3 real-valued orthonormal frame rotation matrix. The direction of the rotation depends on the <code>IsParentToChild</code> field.
IsParentToChild	A logical scalar indicating if <code>Orientation</code> performs a frame rotation from the parent coordinate frame to the child coordinate frame. If <code>false</code> , <code>Orientation</code> performs a frame rotation from the child coordinate frame to the parent coordinate frame.
HasElevation	A logical scalar indicating if elevation is included in the measurement. For measurements reported in a rectangular frame, and if <code>HasElevation</code> is <code>false</code> , the measurements are reported assuming 0 degrees of elevation.
HasAzimuth	A logical scalar indicating if azimuth is included in the measurement.
HasRange	A logical scalar indicating if range is included in the measurement.
HasVelocity	A logical scalar indicating if the reported detections include velocity measurements. For measurements reported in the rectangular frame, if <code>HasVelocity</code> is <code>false</code> , the measurements are reported as <code>[x y z]</code> . If <code>HasVelocity</code> is <code>true</code> , measurements are reported as <code>[x y z vx vy vz]</code> .

Object Attributes

Object attributes contain additional information about a detection:

Attribute	Description
TargetIndex	Identifier of the platform, <code>PlatformID</code> , that generated the detection. For false alarms, this value is negative.
SNR	Detection signal-to-noise ratio in dB.

See Also

`emit` | `pose` | `targetPoses`

Introduced in R2018b

lidarDetect

Report point cloud detections from all lidar sensor on platform

Syntax

```
pointClouds = lidarDetect(plat,time)
pointClouds = lidarDetect(plat,time,includeSelf)
[pointClouds,configs] = lidarDetect(____)
[pointClouds,configs, clusters] = lidarDetect(____)
```

Description

`pointClouds = lidarDetect(plat,time)` reports the point cloud detections from all `monostaticLidarSensor` object mounted on the ego platform, `plat`.

`pointClouds = lidarDetect(plat,time,includeSelf)` allows you to choose whether the lidar sensor reports detections of the ego platform, `plat`, on which the sensors are mounted. Specify `includeSelf` as `true` or `false`.

`[pointClouds,configs] = lidarDetect(____)` also returns the configurations of the sensors, `configs`, at the current simulation time. You can use these output arguments with any of the previous input syntaxes.

`[pointClouds,configs, clusters] = lidarDetect(____)` also returns `clusters`, the cluster labels for each point in the point cloud.

Examples

Generate Lidar Detection for Platform

Create a tracking scenario.

```
sc = trackingScenario;
rng(2020)% for repeatable results
```

Add an ego platform to the tracking scenario.

```
ego = platform(sc);
```

Add a target platform to the tracking scenario.

```
target = platform(sc);
```

Define a simple waypoint trajectory for the target.

```
traj = waypointTrajectory("Waypoints",[1 1 1; 2 2 2],"TimeOfArrival",[0,1]);
target.Trajectory = traj;
```

Define a sphere mesh for the target.

```
target.Mesh = extendedObjectMesh("Sphere");
target.Dimensions = struct("Length",4,"Width",3,"Height",2,"OriginOffset",[0 0 0]);
```

Show the mesh of the target.

```
figure()
show(target.Mesh);
legend("Target Mesh")
xlabel('x (m)'); ylabel('y (m)'); zlabel('z (m)');
```

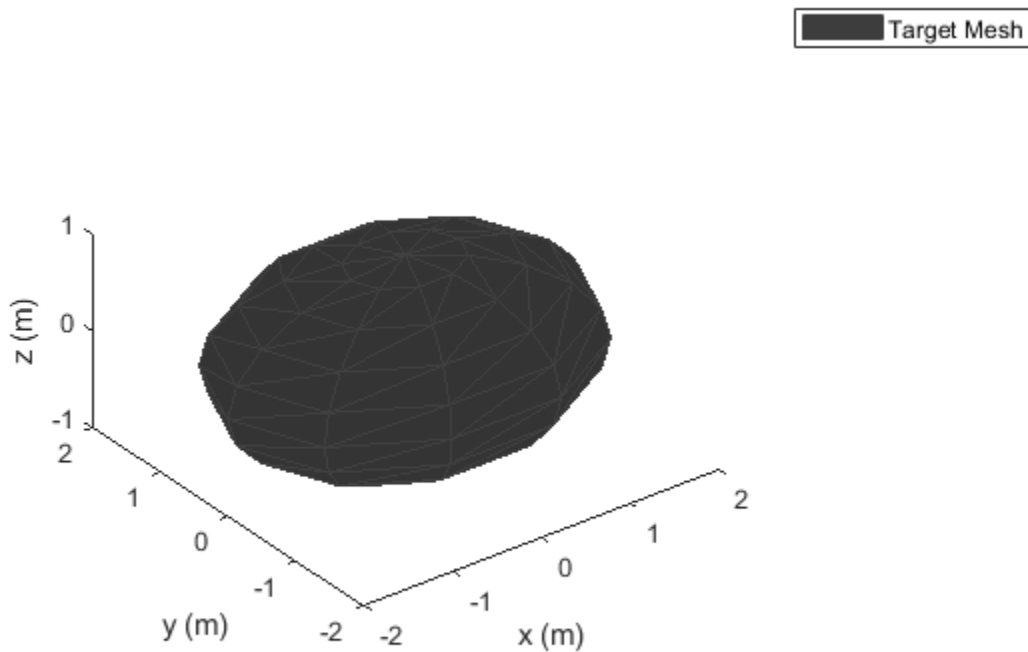

Create two lidar sensors with different range accuracy. Mount them on the ego platform.

```
sensor1 = monostaticLidarSensor(1,"RangeAccuracy",0.01);
sensor2 = monostaticLidarSensor(2,"RangeAccuracy",0.1);
ego.Sensors = {sensor1;sensor2};
```

Generate detections from the two lidar sensor using lidarDetect.

```
[pointClouds,configs,clusters] = lidarDetect(ego,0);
```

Visualize the results.

```
cloud1 = pointClouds{1};
cloud2 = pointClouds{2};
figure()
plot3(cloud1(:,1),cloud1(:,2),cloud1(:,3),'bo')
hold on
plot3(cloud2(:,1),cloud2(:,2),cloud2(:,3),'go')
```

```
legend('Sensor1','Sensor2')
xlabel('x (m)'); ylabel('y (m)'); zlabel('z (m)')
```

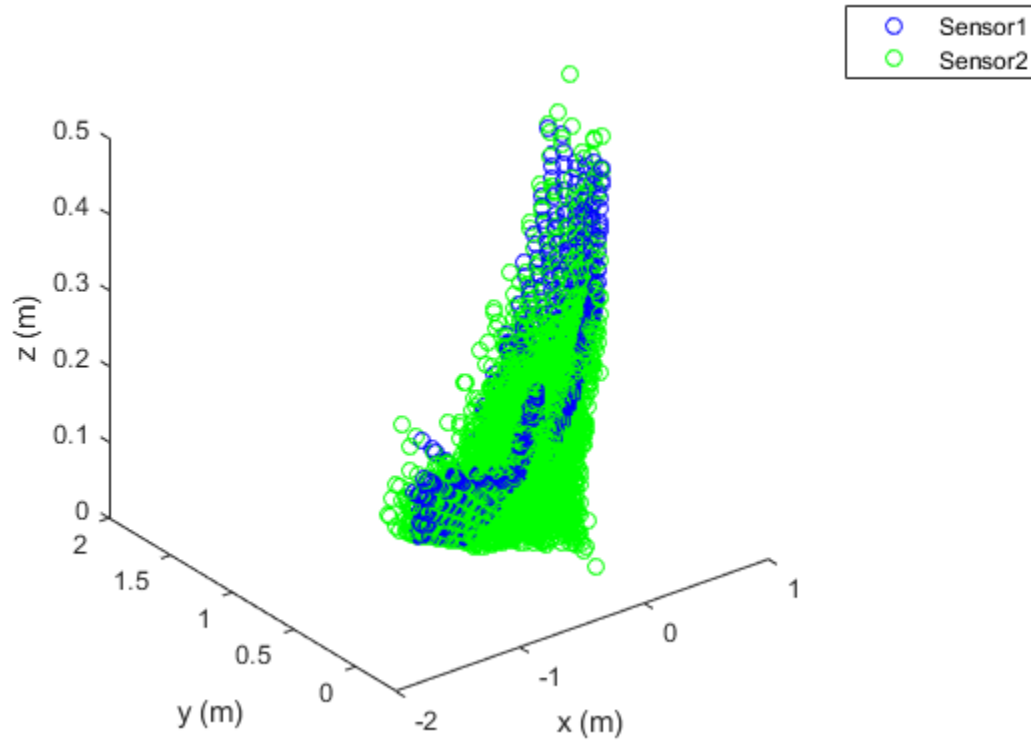

Input Arguments

plat – Ego platform

Platform object

Ego platform, specified as a Platform object.

time – Current simulation time

nonnegative scalar

Current simulation time, specified as a positive scalar in seconds.

Data Types: double

includeSelf – Enable sensors reporting ego platform's mesh detection

false (default) | true

Enable reporting ego platform's mesh detection in the output, specified as true or false.

Output Arguments

pointClouds — Detection point clouds

K-element cell array

Point cloud detections generated by the sensors, returned as a *K*-element cell array. *K* is the number of `monostaticLidarSensor` objects mounted on the platform, `plat`. Each cell element is an array representing the point cloud generated by the corresponding sensor. The dimension of the array is determined by the `HasOrganizedOutput` property of the sensor.

- When this property is set as `true`, the cell element is returned an *N*-by-*M*-by-3 array of scalars, where *N* is the number of elevation channels, and *M* is the number of azimuth channels.
- When this property is set as `false`, the cell element is returned as an *P*-by-3 matrix of scalars, where *P* is the product of the numbers of elevation and azimuth channels.

The coordinate frame in which the point cloud locations are reported is determined by the `DetectionCoordinates` property of the sensor.

configs — Current sensor configurations

K-element array of structure

Current sensor configurations, returned as a *K*-element array of structures. *K* is the number of `monostaticLidarSensor` objects mounted on the platform, `plat`. Each structure has these fields:

Field	Description
<code>SensorIndex</code>	Unique sensor index, returned as a positive integer.
<code>IsValidTime</code>	Valid detection time, returned as <code>true</code> or <code>false</code> . <code>IsValidTime</code> is <code>false</code> when detection updates are requested between update intervals specified by the update rate.
<code>IsScanDone</code>	<code>IsScanDone</code> is <code>true</code> when the sensor has completed a scan.
<code>FieldOfView</code>	Field of view of the sensor, returned as a 2-by-2 matrix of positive real values. The first row elements are the lower and upper azimuth limits; the second row elements are the lower and upper elevation limits.
<code>MeasurementParameters</code>	Sensor measurement parameters, returned as an array of structures containing the coordinate frame transforms needed to transform positions and velocities in the top-level frame to the current sensor frame.

Data Types: `struct`

clusters — Cluster labels of points

K-element cell array

Cluster labels of points in the `pointClouds` output, returned as a *K*-element cell array. *K* is the number of `monostaticLidarSensor` objects mounted on the platform, `plat`. Each cell element is

an array representing cluster labels of points in the point cloud generated by the corresponding sensor. The dimension of the array is determined by the `HasOrganizedOutput` of the sensor.

- When this property is set as `true`, the cell element is returned as an N -by- M -by-2 array of scalars, where N is the number of elevation channels, and M is the number of azimuth channels. On the third dimension, the first element represents the `PlatformID` of the target generating the point whereas the second element represents the `ClassID` of the target.
- When this property is set as `false`, the cell element is returned as a P -by-2 matrix of scalars, where P is the product of the numbers of elevation and azimuth channels. For each column of the matrix, the first element represents the `PlatformID` of the target generating the point whereas the second element represents the `ClassID` of the target.

See Also

`extendedObjectMesh` | `monostaticLidarSensor` | `targetMeshes`

Introduced in R2020b

Platform.targetPoses

Target positions and orientations as seen from platform

Syntax

```
poses = targetPoses(ptfm)
```

Description

`poses = targetPoses(ptfm)` returns the poses of all targets in a scenario with respect to the platform `ptfm`. Targets are defined as platforms as seen by another platform and are located with respect to the coordinate system of that platform. Pose represents the position, velocity, and orientation of a target with respect to the coordinate system belonging to the platform, `ptfm`. The targets must already exist in the tracking scenario. Add targets using the `platform` method.

Input Arguments

ptfm — Scenario platform

Platform object

Scenario platform, specified as a Platform object. To create platforms, use the `platform` method.

Output Arguments

poses — Poses of all targets

structure | array of structures

Poses for all targets, returned as a structure or an array of structures. The pose of the input platform, `ptfm`, is not included. Pose consists of the position, velocity, orientation, and signature of a target in platform coordinates. The returned structure has these fields:

Field	Description
PlatformID	Unique identifier for the platform, specified as a positive integer. This is a required field with no default value.
ClassID	User-defined integer used to classify the type of target, specified as a nonnegative integer. 0 is reserved for unclassified platform types and is the default value.
Position	Position of target in platform coordinates, specified as a real-valued, 1-by-3 vector. This is a required field with no default value. Units are in meters.
Velocity	Velocity of target in platform coordinates, specified as a real-valued, 1-by-3 vector. Units are in meters per second. The default is [0 0 0].

Field	Description
Acceleration	Acceleration of target in platform coordinates, specified as a 1-by-3 row vector. Units are in meters per second-squared. The default is [0 0 0].
Orientation	Orientation of the target with respect to platform coordinates, specified as a scalar quaternion or a 3-by-3 rotation matrix. Orientation defines the frame rotation from the platform coordinate system to the current target body coordinate system. Units are dimensionless. The default is quaternion(1,0,0,0).
AngularVelocity	Angular velocity of the target in platform coordinates, specified as a real-valued, 1-by-3 vector. The magnitude of the vector defines the angular speed. The direction defines the axis of clockwise rotation. Units are in degrees per second. The default is [0 0 0].

See Also

detect | emit | pose

Introduced in R2018b

targetMeshes

Target meshes as seen from platform

Syntax

```
tgtMeshes = targetMeshes(plat)
tgtMeshes = targetMeshes(plat,reportSelf)
tgtMeshes = targetMeshes(plat,reportSelf,format)
```

Description

`tgtMeshes = targetMeshes(plat)` returns the relative pose and meshes of all other platforms seen from the ego platform, `plat`.

`tgtMeshes = targetMeshes(plat,reportSelf)` allows you to choose whether report mesh information about the ego platform, `plat`. Specify `reportSelf` as `true` or `false`.

`tgtMeshes = targetMeshes(plat,reportSelf,format)` allows you to specify the format of orientation as quaternion or rotation matrix in the `tgtMeshes` output.

Examples

Obtain Mesh of Target

Create a tracking scenario. Create an ego platform and a target platform.

```
scenario = trackingScenario;
ego = platform(scenario, 'Position', [1 1 1]);
target = platform(scenario, 'Trajectory', kinematicTrajectory('Position', [10 -3 0], 'Velocity', [5 0
```

Define the target's mesh and adjust its dimensions.

```
target.Mesh = extendedObjectMesh('sphere');
target.Dimensions.Length = 5;
target.Dimensions.Width = 3;
target.Dimensions.Height = 2;
```

Get the mesh of the target viewed from the ego platform.

```
tgtmeshes = targetMeshes(ego);
```

Show the derived mesh of the target from the view of the ego platform.

```
show(tgtmeshes.Mesh);
```

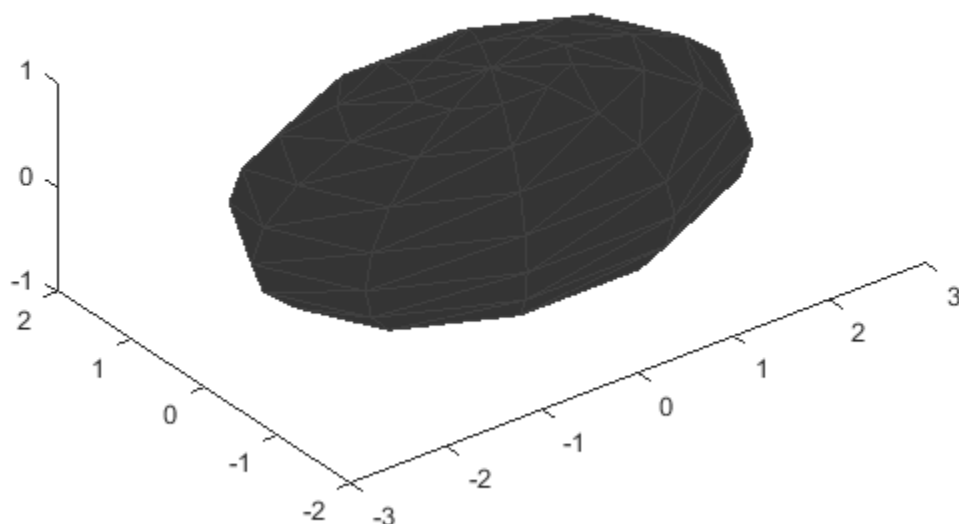

Input Arguments

plat — Ego platform

Platform object

Ego platform, specified as a Platform object.

reportSelf — Enable reporting ego platform's mesh information

false (default) | true

Enable reporting ego platform's mesh information, specified as true or false.

format — Orientation output format

'quaternion (default) | 'rotmat'

Orientation output format, specified as 'quaternion or 'rotmat'. When specified as 'quaternion, the orientation is given by quaternion. When specified as 'rotmat', the orientation output is given by rotation matrix.

Output Arguments

tgtMeshes — Pose and meshes of target platforms

array of structure

Pose and meshes of target platforms relative to the ego platform `plat`, returned as an array of structures. Each structure contains these fields:

Field Name	Description
PlatformID	Unique identifier of the target, specified as a nonnegative integer.
ClassID	Unique identifier of the class of the target, specified as a nonnegative integer.
Position	Position of the target with respect to the sensor mounting platform's body frame, specified as a 3-element vector of scalars.
Orientation	Orientation of the target with respect to the sensor mounting platform's body frame, specified as a quaternion object or a rotation matrix.
Mesh	Geometric mesh of the target, specified as an <code>extendedObjectMesh</code> object with respect to the target's body frame.

See Also

`lidarDetect` | `monostaticLidarSensor`

Introduced in R2020b

Platform.pose

Pose of platform

Syntax

```
pse = pose(ptfm)
pse = pose(ptfm,type)
pse = pose( ____, 'CoordinateSystem', coordinate)
```

Description

`pse = pose(ptfm)` returns the estimated pose, `pse`, of the platform `ptfm`, in scenario coordinates. The platform must already exist in the tracking scenario. Add platforms to a scenario using the `platform` method. The pose is estimated by a pose estimator specified in the `PoseEstimator` property of the platform.

`pse = pose(ptfm,type)` specifies the type of the pose estimation as 'estimated' or 'true'.

`pse = pose(____, 'CoordinateSystem', coordinate)` specifies the coordinate system of the `pse` output. You can only use this syntax when the `IsEarthCentered` property of the tracking scenario is set to `true`.

Examples

Create Earth Centered Scenario

Create a tracking scenario with a specified update rate.

```
scene = trackingScenario('IsEarthCentered',true,'UpdateRate',0.01);
```

Add an airplane in the scenario. The trajectory of the airplane changes in latitude and altitude.

```
plane = platform(scene,'Trajectory',geoTrajectory([-12.338,-71.349,10600;42.390,-71.349,0],[0 360]));
```

Advance the tracking scenario and record the geodetic and Cartesian positions of the plane target.

```
positions = [];
while advance(scene)
    poseLLA = pose(plane,'CoordinateSystem','Geodetic');
    poseCart = pose(plane,'CoordinateSystem','Cartesian');
    positions = [positions;poseCart.Position];%#ok<AGROW> Allow the buffer to grow.
end
```

Visualize the trajectory in the ECEF frame.

```
figure()
km = 1000;
% Plot the trajectory.
plot3(positions(1,1)/km,positions(1,2)/km,positions(1,3)/km, 'b*');
hold on;
plot3(positions(end,1)/km,positions(end,2)/km,positions(end,3)/km, 'bo');
```

```

plot3(positions(:,1)/km,positions(:,2)/km,positions(:,3)/km,'b');
% Plot the Earth radial lines.
plot3([0 positions(1,1)]/km,[0 positions(1,2)]/km,[0 positions(1,3)]/km,'k:');
plot3([0 positions(end,1)]/km,[0 positions(end,2)]/km,[0 positions(end,3)]/km,'k:');
xlabel('x (km)'); ylabel('y (km)'); zlabel('z (km)');
legend('Start position','End position','Trajectory')

```

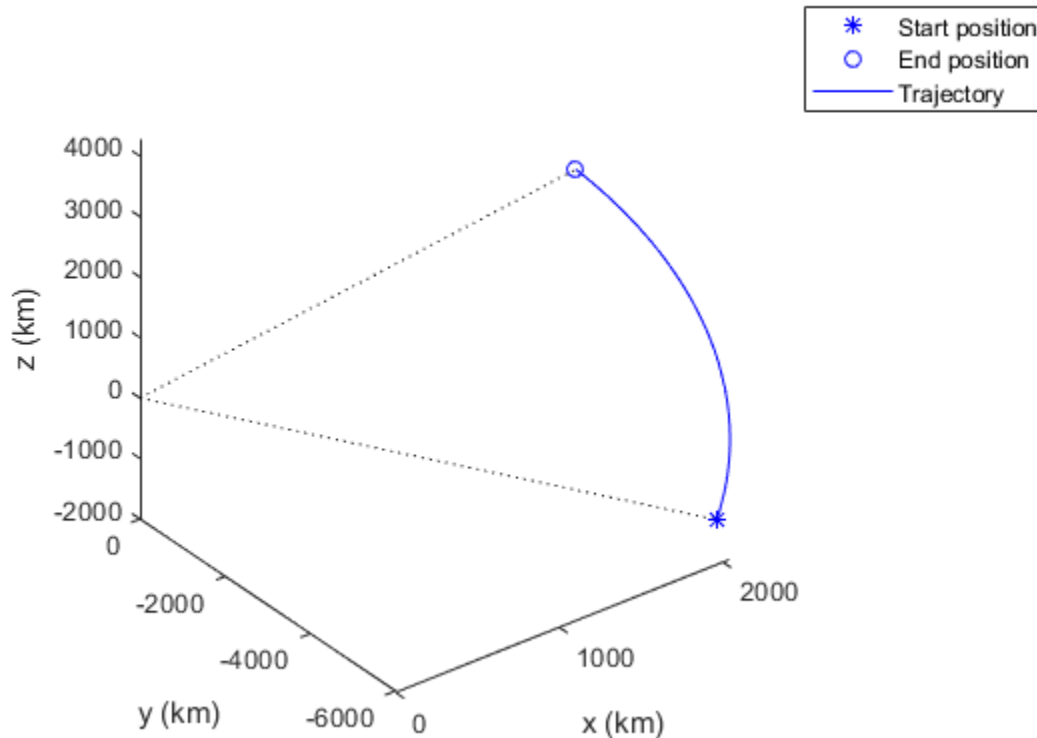

Input Arguments

platform — Scenario platform

Platform object

Scenario platform, specified as a `Platform` object. To create platforms, use the `platform` method.

type — Source of platform pose information

'estimated' (default) | 'true'

Source of platform pose information, specified as 'estimated' or 'true'. When set to 'estimated', the pose is estimated using the pose estimator specified in the `PoseEstimator` property of the tracking scenario. When 'true' is selected, the true pose of the platform is returned.

Example: 'true'

Data Types: char

coordinate — Coordinate system to report pose

'Cartesian' (default) | 'Geodetic'

Coordinate system to report pose, specified as:

- 'Cartesian' — Report poses using Cartesian coordinates in the Earth-Centered-Earth-Fixed coordinate frame.
- 'Geodetic' — Report positions using geodetic coordinates (latitude, longitude, and altitude). Report orientation, velocity, and acceleration in the local reference frame (North-East-Down by default) corresponding to the current waypoint.

You can only use this argument when the `IsEarthCentered` property of the tracking scenario is set to `true`.

Output Arguments**pse — Pose of platform**

structure

Pose of platform, returned as a structure. Pose consists of the position, velocity, orientation, and angular velocity of the platform with respect to scenario coordinates. The returned structure has these fields:

Field	Description
PlatformID	Unique identifier for the platform, specified as a positive integer. This is a required field with no default value.
ClassID	User-defined integer used to classify the type of target, specified as a nonnegative integer. Zero is reserved for unclassified platform types and is the default value.
Position	Position of target in scenario coordinates, specified as a real-valued 1-by-3 row vector. <ul style="list-style-type: none"> • If the <code>coordinateSystem</code> argument is specified as 'Cartesian', the <code>Position</code> is the 3-element Cartesian position coordinates in meters. • If the <code>coordinateSystem</code> argument is specified as 'Geodetic', the <code>Position</code> is the 3-element geodetic coordinates: latitude in degrees, longitude in degrees, and altitude in meters.
Velocity	Velocity of platform in scenario coordinates, specified as a real-valued 1-by-3 row vector. units are meters per second. The default value is $[0 \ 0 \ 0]$.

Field	Description
Acceleration	Acceleration of the platform in scenario coordinates, specified as a 1-by-3 row vector in meters per second squared. The default value is [0 0 0].
Orientation	Orientation of the platform with respect to the local scenario navigation frame, specified as a scalar quaternion or a 3-by-3 rotation matrix. Orientation defines the frame rotation from the local navigation coordinate system to the current platform body coordinate system. Units are dimensionless. The default value is quaternion(1,0,0,0).
AngularVelocity	Angular velocity of the platform in scenario coordinates, specified as a real-valued 1-by-3 vector. The magnitude of the vector defines the angular speed. The direction defines the axis of clockwise rotation. units are degrees per second. The default value is [0 0 0].

See Also

detect | emit | targetPoses

Introduced in R2018b

platform

Add platform to tracking scenario

Syntax

```
ptfm = platform(sc)
ptfm = platform(sc,Name,Value)
```

Description

`ptfm = platform(sc)` adds a `Platform` object, `ptfm`, to the tracking scenario, `sc`. The function creates a platform with default property values. Platforms are defined as points or cuboids with aspect-dependent properties. Each platform is automatically assigned a unique ID specified in the `platformID` field of the `Platform` object.

`ptfm = platform(sc,Name,Value)` adds a platform with additional properties specified by one or more `Name,Value` pair arguments. `Name` is a property name and `Value` is the corresponding value. `Name` must appear inside single quotes (`' '`). You can specify several name-value pair arguments in any order as `Name1,Value1, . . . ,NameN,ValueN`. Any unspecified properties take default values.

Input Arguments

sc — Tracking scenario

`trackingScenario` object

Tracking scenario, specified as a `trackingScenario` object.

Name-Value Pair Arguments

Specify optional comma-separated pairs of `Name,Value` arguments. `Name` is the argument name and `Value` is the corresponding value. `Name` must appear inside quotes. You can specify several name and value pair arguments in any order as `Name1,Value1, . . . ,NameN,ValueN`.

ClassID — Platform classification identifier

0 (default) | nonnegative integer

Platform classification identifier specified as a nonnegative integer. You can define your own platform classification scheme and assign `ClassID` values to platforms according to the scheme. The value of 0 is reserved for an object of unknown or unassigned class.

Example: 5

Data Types: `double`

Position — Position of platform

3-element vector of scalar

This property is read-only.

Current position of the platform, specified as a 3-element vector of scalars.

- When the `IsEarthCentered` property of the scenario is set to `false`, the position is specified as a three element Cartesian state $[x, y, z]$ in meters.
- When the `IsEarthCentered` property of the scenario is set to `true`, the position is specified as a three element geodetic state: `latitude` in degrees, `longitude` in degrees, and `altitude` in meters.

You should only specify position when creating a stationary platform. If you choose to specify the trajectory of the platform, do not use `Position`. Instead, use the `Trajectory` argument.

Data Types: `double`

Orientation – Orientation of platform

3-element vector of scalar

This property is read-only.

Orientation of the platform, specified as a 3-element vector of scalars in degrees. The three scalars are the `[yaw, pitch, roll]` rotation angles from the local reference frame to the platform's body frame.

You should only specify `Orientation` when creating a stationary platform. If you choose to specify the orientation over time, use the `Trajectory` argument.

Data Types: `double`

Dimensions – Platform dimensions and origin offset

struct

Platform dimensions and origin offset, specified as a structure. The structure contains the `Length`, `Width`, `Height`, and `OriginOffset` of a cuboid that approximates the dimensions of the platform. The `OriginOffset` is the position vector from the center of the cuboid to the origin of the platform coordinate frame. The `OriginOffset` is expressed in the platform coordinate system. For example, if the platform origin is at the center of the cuboid rear face as shown in the following figure, then set `OriginOffset` as $[-L/2, 0, 0]$. The default value for `Dimensions` is a structure with all fields set to zero, which corresponds to a point model.

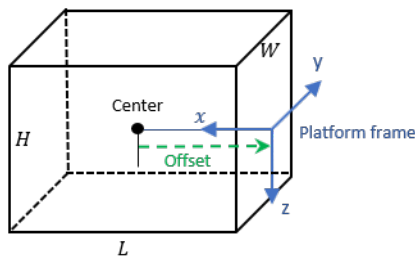

Fields of Dimensions

Fields	Description	Default
Length	Dimension of a cuboid along the x direction	0
Width	Dimension of a cuboid along the y direction	0
Height	Dimension of a cuboid along the z direction	0
OriginOffset	Position of the platform coordinate frame origin with respect to the cuboid center	[0 0 0]

Example: `struct('Length',5,'Width',2.5,'Height',3.5,'OriginOffset',[-2.5 0 0])`

Data Types: `struct`

Trajectory – Platform motion

`kinematicTrajectory` object | `waypointTrajectory` object | `geoTrajectory` object

Platform motion, specified as either a `kinematicTrajectory` object, a `waypointTrajectory` object, or a `geoTrajectory` object. The trajectory object defines the time evolution of the position and velocity of the platform frame origin, as well as the orientation of the platform frame relative to the scenario frame.

- When the `IsEarthCentered` property of the scenario is set to `false`, you can use the `kinematicTrajectory` or the `waypointTrajectory` object. By default, a stationary `kinematicTrajectory` object is used.
- When the `IsEarthCentered` property of the scenario is set to `true`, you can only use the `geoTrajectory` object. By default, a stationary `geoTrajectory` object is used.

Signatures – Platform signatures

`{rcsSignature irSignature tsSignature}` (default) | cell array of signature objects

Platform signatures, specified as a cell array of `irSignature`, `rcsSignature`, and `tsSignature` objects or an empty cell array. The cell array contains at most only one instance for each type of signature objects listed. A signature represents the reflection or emission pattern of a platform such as its radar cross-section, target strength, or IR intensity.

PoseEstimator – Platform pose estimator

`insSensor` System object (default) | pose estimator object

A pose estimator, specified as a pose estimator object. The pose estimator determines platform pose with respect to the local NED scenario coordinate. The interface of any pose estimator must match the interface of `insSensor`. By default, pose estimator accuracy properties are set to zero.

Emitters – Emitters mounted on platform

cell array of emitter objects

Emitters mounted on the platform, specified as a cell array of emitter objects, such as `radarEmitter` or `sonarEmitter`.

Sensors — Sensors mounted on platform

cell array of sensor objects

Sensors mounted on platform, specified as a cell array of sensor objects such as `irSensor`, `fusionRadarSensor`, `monostaticLidarSensor`, or `sonarSensor`.

Output Arguments**platform — Scenario platform**

Platform object

Scenario platform, returned as a Platform object.

Examples**Platform Follows Circular Trajectory**

Create a tracking scenario and a platform following a circular path.

```
scene = trackingScenario('UpdateRate',1/50);

% Create a platform
plat = platform(scene);

% Follow a circular trajectory 1 km in radius completing in 400 hundred seconds.
plat.Trajectory = waypointTrajectory('Waypoints', [0 1000 0; 1000 0 0; 0 -1000 0; -1000 0 0; 0 1000 0];
    'TimeOfArrival', [0; 100; 200; 300; 400]);

% Perform the simulation
while scene.advance
    p = pose(plat);
    fprintf('Time = %f ', scene.SimulationTime);
    fprintf('Position = [');
    fprintf('%f ', p.Position);
    fprintf('] Velocity = [');
    fprintf('%f ', p.Velocity);
    fprintf(']\n');
end

Time = 0.000000
Position = [
0.000000 1000.000000 0.000000
] Velocity = [
15.707701 -0.000493 0.000000
]
Time = 50.000000
Position = [
707.095476 707.100019 0.000000
```

```
] Velocity = [  
11.107152 -11.107075 0.000000  
]  
Time = 100.000000  
Position = [  
1000.000000 0.000000 0.000000  
] Velocity = [  
0.000476 -15.707961 0.000000  
]  
Time = 150.000000  
Position = [  
707.115558 -707.115461 0.000000  
] Velocity = [  
-11.107346 -11.107341 0.000000  
]  
Time = 200.000000  
Position = [  
0.000000 -1000.000000 0.000000  
] Velocity = [  
-15.707963 0.000460 0.000000  
]  
Time = 250.000000  
Position = [  
-707.098004 -707.098102 0.000000  
] Velocity = [  
-11.107069 11.107074 0.000000  
]  
Time = 300.000000  
Position = [  
-1000.000000 0.000000 0.000000  
] Velocity = [  
-0.000476 15.707966 0.000000
```

```

]
Time = 350.000000
Position = [
-707.118086 707.113543 0.000000
] Velocity = [
11.107262 11.107340 0.000000
]
Time = 400.000000
Position = [
-0.000000 1000.000000 0.000000
] Velocity = [
15.708226 -0.000493 0.000000
]

```

Cuboid Platforms Follow Circular Trajectories

Create a tracking scenario with two cuboid platforms following circular trajectories.

```

sc = trackingScenario;

% Create the platform for a truck with dimension 5 x 2.5 x 3.5 (m).
p1 = platform(sc);
p1.Dimensions = struct('Length',5,'Width',2.5,'Height',3.5,'OriginOffset',[0 0 0]);

% Specify the truck's trajectory as a circle with radius 20 meters.
p1.Trajectory = waypointTrajectory('Waypoints', [20*cos(2*pi*(0:10)'/10)...
          20*sin(2*pi*(0:10)'/10) -1.75*ones(11,1)], ...
          'TimeOfArrival', linspace(0,50,11)');

% Create the platform for a small quadcopter with dimension .3 x .3 x .1 (m).
p2 = platform(sc);
p2.Dimensions = struct('Length',.3,'Width',.3,'Height',.1,'OriginOffset',[0 0 0]);

% The quadcopter follows the truck at 10 meters above with small angular delay.
% Note that the negative z coordinates correspond to positive elevation.
p2.Trajectory = waypointTrajectory('Waypoints', [20*cos(2*pi*((0:10)'-.6)/10)...
          20*sin(2*pi*((0:10)'-.6)/10) -11.80*ones(11,1)], ...
          'TimeOfArrival', linspace(0,50,11)');

```

Visualize the results using theaterPlot.

```

tp = theaterPlot('XLim',[-30 30],'YLim',[-30 30],'Zlim',[-12 5]);
pp1 = platformPlotter(tp,'DisplayName','truck','Marker','s');
pp2 = platformPlotter(tp,'DisplayName','quadcopter','Marker','o');

```

```
% Specify a view direction and animate.
view(-28,37);
set(gca,'Zdir','reverse');

while advance(sc)
    poses = platformPoses(sc);
    plotPlatform(pp1, poses(1).Position, p1.Dimensions, poses(1).Orientation);
    plotPlatform(pp2, poses(2).Position, p2.Dimensions, poses(2).Orientation);
end
```

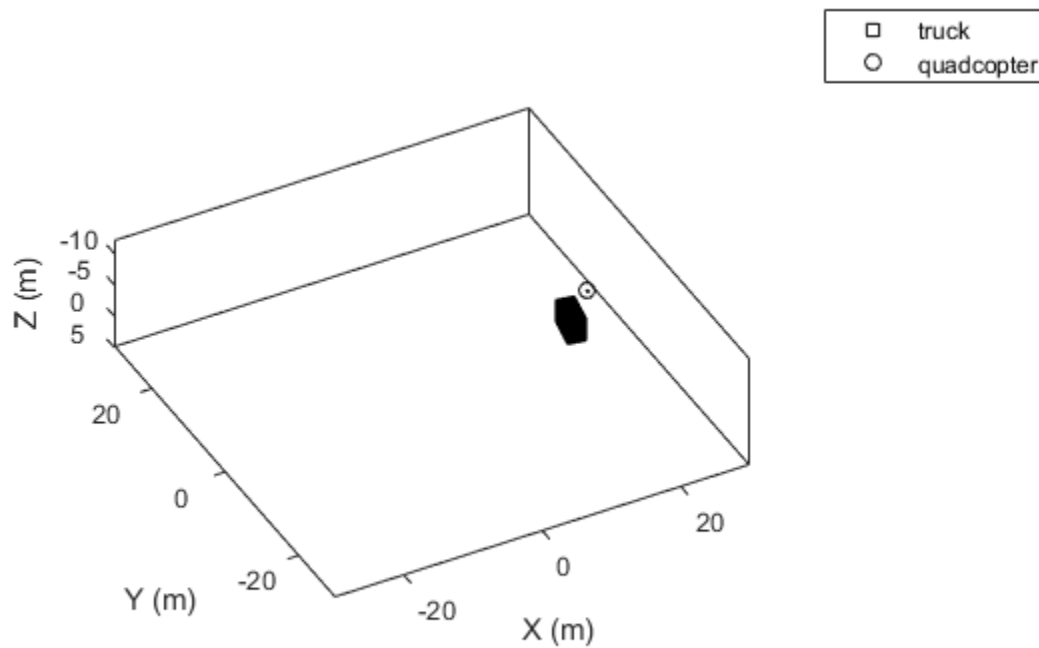

See Also

Objects

Platform | kinematicTrajectory | waypointTrajectory

Introduced in R2018b

advance

Advance tracking scenario simulation by one time step

Syntax

```
isrunning = advance(sc)
```

Description

`isrunning = advance(sc)` advances simulation of the tracking scenario, `sc`, and returns the running status of the scenario. Set up the advance behavior using the `UpdateRate` and `InitialAdvance` properties of the `trackingScenario` object.

- When the `UpdateRate` property is specified as a positive scalar F , the scenario advances in the time step of $1/F$. Moreover, if the `InitialAdvance` property is specified as 'Zero', the scenario starts at time 0. If the `InitialAdvance` property is specified as 'UpdateInterval', then the scenario starts at time $1/F$.
- When the `UpdateRate` property is specified as 0, the scenario advances based on the necessity of updating sensors or emitters mounting on the platforms in the scenario. In this case, the initial time is always time 0. Also, you need to trigger the running of the sensors or emitters by using at least one of the these options between advance calls:
 - Directly running the sensors or emitters
 - Using the `emit`, `detect`, or `lidarDetect` function of the tracking scenario to run sensors or emitters in the scenario
 - Using the `emit`, `detect`, or `lidarDetect` function of the platform with a corresponding sensors or emitters

Examples

Advance a Tracking Scenario

Create a tracking scenario and set its `InitialAdvance` property to `UpdateInterval`.

```
scene = trackingScenario('UpdateRate',10);
scene.InitialAdvance = 'UpdateInterval';
```

Create a platform and define its trajectory. Mount a sensor on the platform.

```
plat = platform(scene);
traj = waypointTrajectory('Waypoints', [0 1 0; 1 0 0; 0 -1 0; -1 0 0; 0 1 0], ...
    'TimeOfArrival', [0; 0.25; .5; .75; 1.0]);
sensor = fusionRadarSensor(1,'UpdateRate',20)
```

```
sensor =
    fusionRadarSensor with properties:
```

```
    SensorIndex: 1
    UpdateRate: 20
```

```
        DetectionMode: 'Monostatic'
          ScanMode: 'Mechanical'
InterferenceInputPort: 0
EmissionsInputPort: 0

        MountingLocation: [0 0 0]
          MountingAngles: [0 0 0]

          FieldOfView: [1 5]
          RangeLimits: [0 100000]

        DetectionProbability: 0.9000
          FalseAlarmRate: 1.0000e-06
          ReferenceRange: 100000

        TargetReportFormat: 'Clustered detections'
```

Show all properties

```
plat.Trajectory = traj;
plat.Sensors = sensor;
```

Show the simulation status before running the scenario.

```
fprintf('Time = %f, Status is %s\n',...
        scene.SimulationTime, scene.SimulationStatus);
```

```
Time = 0.000000, Status is NotStarted
```

Advance the tracking scenario recursively.

```
while advance(scene)
    p = pose(plat);
    poses = platformPoses(scene);
    detections = sensor(poses,scene.SimulationTime);
    fprintf('Time = %f, Status is %s\n', ...
           scene.SimulationTime, scene.SimulationStatus);
end
```

```
Time = 0.100000, Status is InProgress
Time = 0.200000, Status is InProgress
Time = 0.300000, Status is InProgress
Time = 0.400000, Status is InProgress
Time = 0.500000, Status is InProgress
Time = 0.600000, Status is InProgress
Time = 0.700000, Status is InProgress
Time = 0.800000, Status is InProgress
Time = 0.900000, Status is InProgress
Time = 1.000000, Status is InProgress
```

Show the simulation status after the simulation finishes.

```
fprintf('Time = %f, Status is %s\n', ...
        scene.SimulationTime, scene.SimulationStatus);
```

```
Time = 1.100000, Status is Completed
```

Input Arguments

sc — Tracking scenario

`trackingScenario` object

Tracking scenario, specified as a `trackingScenario` object.

Output Arguments

isrunning — Run-state of simulation

0 | 1

The run-state of the simulation, returned as 0 or 1. If `isrunning` is 1, the simulation is running. If `isrunning` is 0, the simulation has stopped. A simulation stops when either of these conditions is met:

- The stop time is reached.
- Any platform reaches the end of its trajectory.

Units are in seconds.

Introduced in R2018b

detect

Collect detections from all the sensors in tracking scenario

Syntax

```
detections = detect(sc)
detections = detect(sc,signals)
detections = detect(sc,signals,configs)
[detections,sensorConfigs] = detect( ___ )
[detections,sensorConfigs,configIDS] = detect( ___ )
```

Description

`detections = detect(sc)` reports the detections from all sensors mounted on every platform in the tracking scenario, `sc`.

Tip Use this syntax only when none of the sensors requires knowledge of the signals present in the scenario. For example, the `HasInterference` property of `fusionRadarSensor` is set to `false`.

`detections = detect(sc,signals)` reports the detections from all sensors when at least one sensor requires the knowledge of signals in the scenario. For example, when a `fusionRadarSensor` is operating in an ESM mode.

`detections = detect(sc,signals,configs)` reports the detections from all sensors when at least one sensor also requires the knowledge of emitter configurations in the scenario. For example, when a `radarSensor` is configured as a monostatic radar.

`[detections,sensorConfigs] = detect(___)` additionally returns the configurations of each sensor at the detection time.

`[detections,sensorConfigs,configIDS] = detect(___)` additionally returns all platform IDs corresponding to the sensor configurations, `sensorConfigs`.

Examples

Obtain Detections from Two Platforms in Tracking Scenario

Create a tracking scenario.

```
s = rng(0); % For repeatable result
ts = trackingScenario('UpdateRate',1);
```

Create the first platform and mount one emitter and one sensor on it.

```
plat1 = platform(ts);
plat1.Trajectory.Position = [0,0,0];
emitter1 = radarEmitter(1,'UpdateRate',1);
sensor1 = fusionRadarSensor(1,'DetectionMode','Monostatic','RangeResolution',1);
```



```
plat1.Emitters = emitter1;
plat1.Sensors = sensor1;
```

Create the second platform and mount one emitter and one sensor on it.

```
plat2 = platform(ts);
plat2.Trajectory.Position = [100,0,0];
emitter2 = radarEmitter(2, 'UpdateRate',1);
sensor2 = fusionRadarSensor(2, 'DetectionMode', 'Monostatic', 'RangeResolution',1);
plat2.Emitters = emitter2;
plat2.Sensors = sensor2;
```

Advance the tracking scenario, transmit and propagate emissions, and collect signals using the `detect` function.

```
advance(ts);
[emtx,emitterConfs,emitterConfPIDs] = emit(ts); % Transmitted emissions
emprop = propagate(ts,emtx, 'HasOcclusion',true); % Propagate emissions
[dets,sensorConfs,sensorConfPIDs] = detect(ts,emprop,emitterConfs);
```

Display the detection results: Sensor 1 on platform 1 detected platform 2.

```
disp(dets{1})

    objectDetection with properties:
        Time: 0
        Measurement: [3x1 double]
        MeasurementNoise: [3x3 double]
        SensorIndex: 1
        ObjectClassID: 0
        MeasurementParameters: [1x1 struct]
        ObjectAttributes: {[1x1 struct]}

sensor = dets{1}.SensorIndex

sensor = 1

detectedPlatform = dets{1}.ObjectAttributes{1}.TargetIndex

detectedPlatform = 2

rng(s) % Return the random number generator to its previous state
```

Input Arguments

sc — Tracking scenario

trackingScenario object

Tracking scenario, specified as a trackingScenario object.

signals — Signal emissions

cell array of signal emission object

Signal emissions, specified as a cell array of signal emission objects, such as radarEmission and sonarEmission.

configs – Emitter configurations

array of emitter configuration structures

Emitter configurations, specified as an array of emitter configuration structures. The fields of each structure are:

Field	Description
EmitterIndex	Unique emitter index, returned as a positive integer.
IsValidTime	Valid emission time, returned as 0 or 1. <code>IsValidTime</code> is 0 when emitter updates are requested at times that are between update intervals specified by the <code>UpdateInterval</code> property.
IsScanDone	Whether the emitter has completed a scan, returned as <code>true</code> or <code>false</code> .
FieldOfView	Field of view of the emitter, returned as a two-element vector [azimuth; elevation] in degrees.
MeasurementParameters	Emitter measurement parameters, returned as an array of structures containing the coordinate frame transforms needed to transform positions and velocities in the top-level frame to the current emitter frame.

Output Arguments**detections – Detections**cell array of `objectDetection` objects

Detections, returned as a cell array of `objectDetection` objects.

sensorConfigs – Sensor configurations

array of sensor configuration structure

Sensor configurations, return as an array of sensor configuration structures. The fields of each structure are:

Field	Description
SensorIndex	Unique sensor index, returned as a positive integer.
IsValidTime	Valid detection time, returned as <code>true</code> or <code>false</code> . <code>IsValidTime</code> is <code>false</code> when detection updates are requested between update intervals specified by the update rate.
IsScanDone	<code>IsScanDone</code> is <code>true</code> when the sensor has completed a scan.

FieldOfView	Field of view of the sensor, returned as a 2-by-1 vector of positive real values, [azfov;elfov]. azfov and elfov represent the field of view in azimuth and elevation, respectively.
MeasurementParameters	Sensor measurement parameters, returned as an array of structures containing the coordinate frame transforms needed to transform positions and velocities in the top-level frame to the current sensor frame.

configIDS – Platform IDs for sensor configurations

array of positive integer

Platform IDs for sensor configurations in the sensorConfigs output, returned as an array of positive integers.

See Also

emit | objectDetection | propagate | record | trackingScenario

Introduced in R2020a

emit

Collect emissions from emitters in tracking scenario

Syntax

```
emissions = emit(sc)
[emissions,configs] = emit(sc)
[emissions,configs,platformIDs] = emit(sc)
```

Description

`emissions = emit(sc)` reports signals emitted from all the emitters mounted on platforms in the tracking scenario `sc`.

`[emissions,configs] = emit(sc)` also returns the configurations of all the emitters at the emission time.

`[emissions,configs,platformIDs] = emit(sc)` also returns the IDs of platforms on which the emitters are mounted.

Examples

Obtain Emissions from Platforms in Tracking Scenario

Create a tracking scenario and add two platforms. Set the position of each platform and add an emitter.

```
ts = trackingScenario('UpdateRate',1);
plat1 = platform(ts);
plat1.Trajectory.Position = [0,0,0];
emitter1 = radarEmitter(1,'UpdateRate',1);
plat1.Emitters = emitter1;
plat2 = platform(ts);
plat2.Trajectory.Position = [100,0,0];
emitter2 = radarEmitter(2,'UpdateRate',1);
plat2.Emitters = emitter2;
```

Advance the tracking scenario and generate emissions.

```
advance(ts);
[emissions, configs, sensorConfigPIDs] = emit(ts);
```

Print the results.

```
disp("There are " + numel(emissions) + " emissions.");
```

```
There are 2 emissions.
```

The first emission is:

```
disp(emissions{1});
```

radarEmission with properties:

```

    PlatformID: 1
    EmitterIndex: 1
    OriginPosition: [0 0 0]
    OriginVelocity: [0 0 0]
    Orientation: [1x1 quaternion]
    FieldOfView: [1 5]
    CenterFrequency: 300000000
    Bandwidth: 3000000
    WaveformType: 0
    ProcessingGain: 0
    PropagationRange: 0
    PropagationRangeRate: 0
    EIRP: 100
    RCS: 0

```

The second emission is:

```
disp(emissions{2});
```

radarEmission with properties:

```

    PlatformID: 2
    EmitterIndex: 2
    OriginPosition: [100 0 0]
    OriginVelocity: [0 0 0]
    Orientation: [1x1 quaternion]
    FieldOfView: [1 5]
    CenterFrequency: 300000000
    Bandwidth: 3000000
    WaveformType: 0
    ProcessingGain: 0
    PropagationRange: 0
    PropagationRangeRate: 0
    EIRP: 100
    RCS: 0

```

The emitter configuration associated with the first emission is:

```
disp(configs(1));
```

```

    EmitterIndex: 1
    IsValidTime: 1
    IsScanDone: 0
    FieldOfView: [1 5]
    MeasurementParameters: [1x1 struct]

```

The emitter configuration associated with the second emission is:

```
disp(configs(2));
```

```

    EmitterIndex: 2
    IsValidTime: 1
    IsScanDone: 0
    FieldOfView: [1 5]
    MeasurementParameters: [1x1 struct]

```

The emitter configurations are connected with platform IDs:

```
disp(sensorConfigPIDs');
    1     2
```

Input Arguments

sc — Tracking scenario

trackingScenario object

Tracking scenario, specified as a trackingScenario object.

Output Arguments

emissions — Emissions of all emitters

cell array of emission objects

Emissions of all emitters in the tracking scenario, returned as a cell array of emission objects, such as radarEmission and sonarEmission objects.

configs — Configuration of emitters

array of emitter configuration structures

Configuration of all the emitters in the tracking scenario, returned as an array of emitter configuration structures. The fields of each structure are:

Field	Description
EmitterIndex	Unique emitter index, returned as a positive integer.
IsValidTime	Valid emission time, returned as 0 or 1. IsValidTime is 0 when emitter updates are requested at times that are between update intervals specified by the UpdateInterval property.
IsScanDone	Whether the emitter has completed a scan, returned as true or false.
FieldOfView	Field of view of the emitter, returned as a two-element vector [azimuth; elevation] in degrees.
MeasurementParameters	Emitter measurement parameters, returned as an array of structures containing the coordinate frame transforms needed to transform positions and velocities in the top-level frame to the current emitter frame.

platformIDs — Platform IDs

vector of positive integers

Platform IDs, returned as a vector of positive integers. The order of platform IDs output is the same as that of the configs output.

See Also

fusionRadarSensor | radarEmitter | sonarEmitter | sonarSensor | trackingScenario

Introduced in R2020a

clone

Create copy of tracking scenario

Syntax

```
newScenario = clone(scenario)
```

Description

`newScenario = clone(scenario)` creates a copy of the `trackingScenario` scenario.

Examples

Create Copy of Tracking Scenario

Create a tracking scenario object.

```
scene = trackingScenario;
```

Create a copy of the scenario, `scene`.

```
newScene = clone(scene)
```

```
newScene =  
  trackingScenario with properties:
```

```
    IsEarthCentered: 0  
      UpdateRate: 10  
    SimulationTime: 0  
      StopTime: Inf  
    SimulationStatus: NotStarted  
      Platforms: {}
```

Input Arguments

scenario — Tracking scenario

`trackingScenario` object

Tracking scenario, specified as a `trackingScenario` object.

Output Arguments

newScenario — Copy of tracking scenario

`trackingScenario` object

Copy of tracking scenario, returned as a `trackingScenario` object.

See Also

trackingScenario

Introduced in R2020b

perturb

Apply perturbations to tracking scenario

Syntax

```
offsets = perturb(scene)
```

Description

`offsets = perturb(scene)` perturbs the baseline tracking scenario, `scene`, according to the perturbations defined on objects (such as trajectories, sensors, and platforms) in the `scene` and returns offset values. Use the `perturbations` function to define property perturbations on each object.

Examples

Tracking Scenario Perturbation

Create a tracking scenario and add a platform.

```
scenario = trackingScenario;
p = platform(scenario);
```

Add a trajectory to the platform.

```
p.Trajectory = waypointTrajectory('Waypoints',...
    [30 -40 -3; 30 -20 -3; 20 -10 -3; 0 -10 -3; -10 -10 -3]*1e3, ...
    'TimeOfArrival', [0; 100; 150; 350; 450], ...
    'Course', [90;90;180;180;180]);
```

Plot the trajectory.

```
tp = theaterPlot("XLimits",[-20 35]*1e3,"YLimits",[-45 -5]*1e3);
trajPlotter1 = trajectoryPlotter(tp,'DisplayName','Original','Color','b');
plotTrajectory(trajPlotter1,{p.Trajectory.Waypoints});
```

Define perturbations for the waypoints. The following defines perturbations on the first and last waypoints as uniform distributions.

```
perturbations(p.Trajectory, "Waypoints", "Uniform",...
    [-2000 -2000 0; 0 0 0; 0 0 0; 0 0 0; -2000 -2000 0],...
    [+2000 +2000 0; 0 0 0; 0 0 0; 0 0 0; +2000 +2000 0]);
```

Perturb the scenario and observe the changed waypoints of the platform.

```
perturb(scenario);
trajPlotter2 = trajectoryPlotter(tp,'DisplayName','Perturbed','Color','g');
plotTrajectory(trajPlotter2,{p.Trajectory.Waypoints})
```

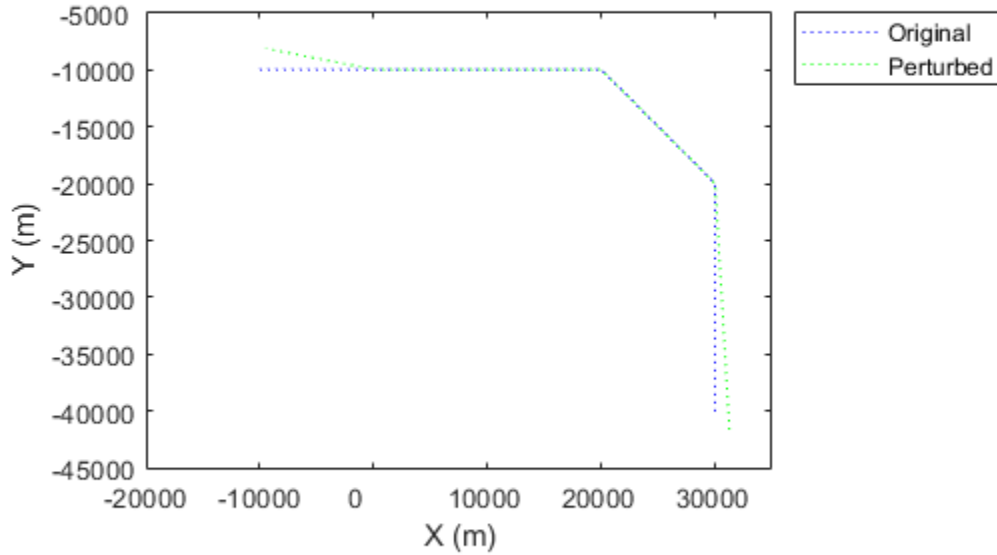

Input Arguments

scene — Tracking scenario

trackingScenario object

Tracking scenario, specified as a trackingScenario object.

Output Arguments

offsets — Property offsets

array of structure

Property offsets, returned as an array of structures. Each structure contains these fields:

Field Name	Description
PlatformID	ID of the platform
PeturbedObject	Perturbed object mounted on the platform
Property	Name of perturbed property
Offset	Offset values applied in the perturbation
PerturbedValue	Property values after the perturbation

See Also
perturbations

Introduced in R2020b

platformPoses

Positions, velocities, and orientations of all platforms in tracking scenario

Syntax

```
poses = platformPoses(sc)
poses = platformPoses(sc,fmt)
poses = platformPoses( ____, 'CoordinateSystem', coordinate)
```

Description

`poses = platformPoses(sc)` returns the current poses for all platforms in the tracking scenario, `sc`. Pose is the position, velocity, and orientation of a platform relative to scenario coordinates. Platforms are Platform objects.

`poses = platformPoses(sc,fmt)` also specifies the format, `fmt`, of the returned platform orientation.

`poses = platformPoses(____, 'CoordinateSystem', coordinate)` specifies the coordinate system of the poses output. You can only use this syntax only when the `IsEarthCentered` property of the tracking scenario, `sc`, is set to `true`.

Input Arguments

sc — Tracking scenario

trackingScenario object

Tracking scenario, specified as a trackingScenario object.

fmt — Pose orientation format

'quaternion' (default) | 'rotmat'

Pose orientation format, specified as 'quaternion' or 'rotmat'. When specified as 'quaternion', the Orientation field of the platform pose structure is a quaternion. When specified as 'rotmat', the Orientation field is a rotation matrix.

Example: 'rotmat'

Data Types: char

coordinate — Coordinate system to report poses

'Cartesian' (default) | 'Geodetic'

Coordinate system to report poses, specified as:

- 'Cartesian' — Report poses using Cartesian coordinates in the Earth-Centered-Earth-Fixed coordinate frame.
- 'Geodetic' — Report positions using geodetic coordinates (latitude, longitude, and altitude). Report orientation, velocity, and acceleration in the local reference frame of each platform (North-East-Down by default) corresponding to the current waypoint.

You can only use this argument when the `IsEarthCentered` property of the tracking scenario, `sc`, is set to `true`.

Output Arguments

poses — Platform poses in scenario coordinates

structures | array of structures

Poses of all platforms in the tracking scenario, returned as a structure or array of structures. The pose structure contains these fields:

Field	Description
PlatformID	Unique identifier for the platform, specified as a positive integer. This is a required field with no default value.
ClassID	User-defined integer used to classify the type of target, specified as a nonnegative integer. Zero is reserved for unclassified platform types and is the default value.
Position	Position of target in scenario coordinates, specified as a real-valued 1-by-3 row vector. <ul style="list-style-type: none"> If the <code>coordinateSystem</code> argument is specified as 'Cartesian', the <code>Position</code> is the 3-element Cartesian position coordinates in meters. If the <code>coordinateSystem</code> argument is specified as 'Geodetic', the <code>Position</code> is the 3-element geodetic coordinates: latitude in degrees, longitude in degrees, and altitude in meters.
Velocity	Velocity of platform in scenario coordinates, specified as a real-valued 1-by-3 row vector. units are meters per second. The default value is <code>[0 0 0]</code> .
Acceleration	Acceleration of the platform in scenario coordinates, specified as a 1-by-3 row vector in meters per second squared. The default value is <code>[0 0 0]</code> .
Orientation	Orientation of the platform with respect to the local scenario navigation frame, specified as a scalar quaternion or a 3-by-3 rotation matrix. Orientation defines the frame rotation from the local navigation coordinate system to the current platform body coordinate system. Units are dimensionless. The default value is <code>quaternion(1,0,0,0)</code> .

Field	Description
AngularVelocity	Angular velocity of the platform in scenario coordinates, specified as a real-valued 1-by-3 vector. The magnitude of the vector defines the angular speed. The direction defines the axis of clockwise rotation. units are degrees per second. The default value is [0 0 0].

Data Types: struct

Introduced in R2018b

platformProfiles

Profiles of platforms in tracking scenario

Syntax

```
profiles = platformProfiles(sc)
```

Description

`profiles = platformProfiles(sc)` returns the profiles of all platforms in the tracking scenario, `sc`.

Input Arguments

sc — Tracking scenario
trackingScenario object

Tracking scenario, specified as a trackingScenario object.

Output Arguments

profiles — Platform profiles
array of structures

Profiles of all platforms in the tracking scenario, returned as an array of structures. The number of structures in the array is equal to the number platforms. Each profile contains the signatures of a platform and identifying information. The structure contains these fields:

Field	Description
PlatformID	Scenario-defined platform identifier, defined as a positive integer
ClassID	User-defined platform classification identifier, defined as a nonnegative integer
Dimensions	Platform dimensions, defined as a structure with these fields: <ul style="list-style-type: none"> • Length • Width • Height • OriginOffset
Signatures	Platform signatures, defined as a cell array of radar cross-section (<code>rccSignature</code>), IR emission pattern (<code>irSignature</code>), and sonar target strength (<code>tsSignature</code>) objects.

See Platform for more completed definitions of the fields.

Examples

Generate Platform Profiles from Tracking Scenario

Create a tracking scenario.

```
scene = trackingScenario;
```

Add two platforms to the tracking scenario. Specify the `ClassID` of the second platform as 3.

```
p1 = platform(scene);  
p2 = platform(scene);  
p2.ClassID = 3;
```

Extract the profiles for platforms in the scene.

```
profiles = platformProfiles(scene)  
  
profiles=1x2 struct array with fields:  
    PlatformID  
    ClassID  
    Dimensions  
    Signatures
```

See Also

[Platform](#) | [trackingScenario](#)

Introduced in R2018b

propagate

Propagate emissions in tracking scenario

Syntax

```
propEmissions = propagate(sc,emissions)
propEmissions = propagate(sc,emissions,'HasOcclusion',tfOcclusion)
```

Description

`propEmissions = propagate(sc,emissions)` returns propagated emissions that are a combination of the input emissions and the reflections of these input emissions from the platforms in the tracking scenario `sc`.

`propEmissions = propagate(sc,emissions,'HasOcclusion',tfOcclusion)` specifies whether the radar channel models occlusion or not. By default, `tfOcclusion` is set to `true`.

Examples

Propagate Emissions from Platforms in Tracking Scenario

Create a tracking scenario and add two platforms. Set the position of each platform and add an emitter.

```
ts = trackingScenario('UpdateRate',1);
plat1 = platform(ts);
plat1.Trajectory.Position = [0,0,0];
emitter1 = radarEmitter(1,'UpdateRate',1);
plat1.Emitters = emitter1;
plat2 = platform(ts);
plat2.Trajectory.Position = [100,0,0];
emitter2 = radarEmitter(2,'UpdateRate',1);
plat2.Emitters = emitter2;
```

Advance the tracking scenario, generate emissions, and obtain propagated emissions.

```
advance(ts);
emtx = emit(ts); % Get emissions
emprop = propagate(ts, emtx, 'HasOcclusion', true)
```

```
emprop=3x1 cell array
    {1x1 radarEmission}
    {1x1 radarEmission}
    {1x1 radarEmission}
```

The last emission was emitted by emitter 1 and reflected from platform 2.

```
disp(emprop{end})

    radarEmission with properties:
```

```

    PlatformID: 2
    EmitterIndex: 1
    OriginPosition: [100 0 0]
    OriginVelocity: [0 0 0]
    Orientation: [1x1 quaternion]
    FieldOfView: [180 180]
    CenterFrequency: 300000000
    Bandwidth: 3000000
    WaveformType: 0
    ProcessingGain: 0
    PropagationRange: 100.0313
    PropagationRangeRate: 0
    EIRP: 38.0131
    RCS: 10

```

Input Arguments

sc — Tracking scenario

trackingScenario object

Tracking scenario, specified as a trackingScenario object.

emissions — Emissions in the tracking scenario

cell array of emission objects

Emissions in the tracking scenario, specified as a cell array of emission objects, such as radarEmission and sonarEmission objects. You can obtain emissions from a tracking scenario using the emit function.

tf0occlusion — Indicate Has0cclusion status

true (default) | false

Indicate Has0cclusion status, specified as true or false.

Output Arguments

propEmissions — Propagated emissions

cell array of emission objects

Propagated emissions in the tracking scenario, specified as a cell array of emission objects, such as radarEmission and sonarEmission objects. The propagated emissions contain the source emissions and the emissions reflected from the platforms.

See Also

emit | radarChannel | trackingScenario | underwaterChannel

Introduced in R2020a

lidarDetect

Report point cloud detections from all lidar sensor in trackingScenario

Syntax

```
pointClouds = lidarDetect(scene)
[pointClouds,configs] = lidarDetect(scene)
[pointClouds,configs, clusters] = lidarDetect( ___ )
```

Description

`pointClouds = lidarDetect(scene)` reports point cloud detections from all `monostaticLidarSensor` objects mounted on every platform in the `trackingScenario`, `scene`.

`[pointClouds,configs] = lidarDetect(scene)` also returns the configurations of the sensors, `configs`, in the tracking scenario.

`[pointClouds,configs, clusters] = lidarDetect(___)` also returns `clusters`, the cluster labels for each point in the point cloud detections.

Examples

Generate Lidar Detection in Tracking Scenario

Create a tracking scenario.

```
sc = trackingScenario;
rng(2020) % for repeatable results
```

Add two platforms to the tracking scenario.

```
plat1 = platform(sc);
plat2 = platform(sc);
```

Add a target platform to the tracking scenario.

```
target = platform(sc);
```

Define a simple waypoint trajectory for the target.

```
traj = waypointTrajectory("Waypoints",[1 1 1; 2 2 2],"TimeOfArrival",[0,1]);
target.Trajectory = traj;
```

Define a sphere mesh for the target.

```
target.Mesh = extendedObjectMesh("Sphere");
target.Dimensions = struct("Length",4,"Width",3,"Height",2,"OriginOffset",[0 0 0]);
```

Show the mesh of the target.

```
figure()
show(target.Mesh);
```

```

legend("Target Mesh")
xlabel('x (m)'); ylabel('y (m)'); zlabel('z (m)');

```

Target Mesh

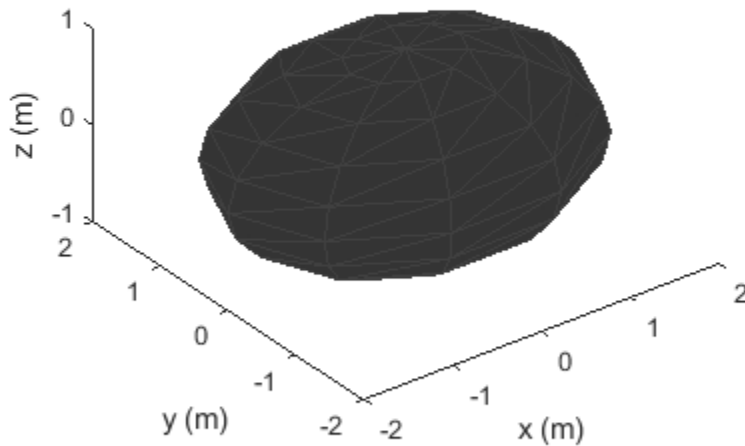

Create two lidar sensors with different range accuracy. Mount them on the two platforms.

```

sensor1 = monostaticLidarSensor(1,"RangeAccuracy",0.01);
sensor2 = monostaticLidarSensor(2,"RangeAccuracy",0.2);
plat1.Sensors = {sensor1};
plat2.Sensors = {sensor2};

```

Generate detections from the two lidar sensor using lidarDetect.

```

[pointClouds,configs,clusters] = lidarDetect(sc);

```

Visualize the results.

```

cloud1 = pointClouds{1};
cloud2 = pointClouds{2};
figure()
plot3(cloud1(:,1),cloud1(:,2),cloud1(:,3),'bo')
hold on
plot3(cloud2(:,1),cloud2(:,2),cloud2(:,3),'go')
legend('Sensor1','Sensor2')
xlabel('x (m)'); ylabel('y (m)'); zlabel('z (m)')

```

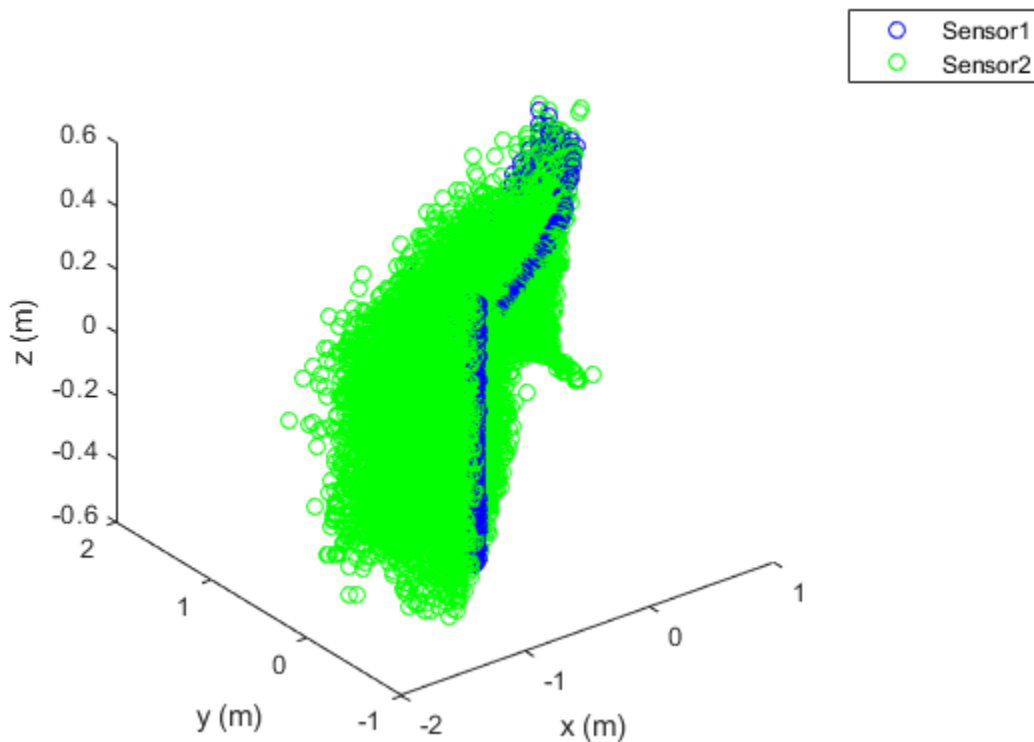

Input Arguments

scene — Tracking scenario

trackingScenario object

Tracking scenario, specified as a trackingScenario object.

Output Arguments

pointClouds — Detection point clouds

K -element cell array

Point cloud detections generated by the sensors, returned as a K -element cell array. K is the number of monostaticLidarSensor objects in the tracking scenario, scene. Each cell element is an array representing the point cloud generated by the corresponding sensor. The dimension of the array is determined by the HasOrganizedOutput property of the sensor.

- When this property is set as true, the cell element is returned an N -by- M -by-3 array of scalars, where N is the number of elevation channels, and M is the number of azimuth channels.
- When this property is set as false, the cell element is returned as an P -by-3 matrix of scalars, where P is the product of the numbers of elevation and azimuth channels.

The coordinate frame in which the point cloud locations are reported is determined by the DetectionCoordinates property of the sensor.

configs — Current sensor configurations*K*-element array of structure

Current sensor configurations, returned as a *K*-element array of structures. *K* is the number of `monostaticLidarSensor` objects in the tracking scenario, `scene`. Each structure has these fields:

Field	Description
<code>SensorIndex</code>	Unique sensor index, returned as a positive integer.
<code>IsValidTime</code>	Valid detection time, returned as <code>true</code> or <code>false</code> . <code>IsValidTime</code> is <code>false</code> when detection updates are requested between update intervals specified by the update rate.
<code>IsScanDone</code>	<code>IsScanDone</code> is <code>true</code> when the sensor has completed a scan.
<code>FieldOfView</code>	Field of view of the sensor, returned as a 2-by-2 matrix of positive real values. The first row elements are the lower and upper azimuth limits; the second row elements are the lower and upper elevation limits.
<code>MeasurementParameters</code>	Sensor measurement parameters, returned as an array of structures containing the coordinate frame transforms needed to transform positions and velocities in the top-level frame to the current sensor frame.

Data Types: `struct`**clusters — Cluster labels of points***K*-element cell array

Cluster labels of points in the `pointClouds` output, returned as a *K*-element cell array. *K* is the number of `monostaticLidarSensor` in the tracking scenario, `scene`. Each cell element is an array representing cluster labels of points in the point cloud generated by the corresponding sensor. The dimension of the array is determined by the `HasOrganizedOutput` of the sensor.

- When this property is set as `true`, the cell element is returned as an *N*-by-*M*-by-2 array of scalars, where *N* is the number of elevation channels, and *M* is the number of azimuth channels. On the third dimension, the first element represents the `PlatformID` of the target generating the point, and the second element represents the `ClassID` of the target.
- When this property is set as `false`, the cell element is returned as a *P*-by-2 matrix of scalars, where *P* is the product of the numbers of elevation and azimuth channels. For each column of the matrix, the first element represents the `PlatformID` of the target generating the point whereas the second element represents the `ClassID` of the target.

See Also

`extendedObjectMesh` | `monostaticLidarSensor` | `targetMeshes`

Introduced in R2020b

record

Run tracking scenario and record platform, sensor, and emitter information

Syntax

```
rec = record(sc)
rec = record(sc, format)
rec = record( ____, Name, Value)
```

Description

`rec = record(sc)` returns a record, `rec`, of the evolution of the tracking scenario simulation, `sc`. The function starts from the beginning of the simulation and stores the record until the end of the simulation. A scenario simulation ends when either the scenario's `StopTime` is reached or any platform in the scenario has finished its trajectory specified by the `Trajectory` property.

Note The `record` function only records detections generated from sensors contained in the scenario and does not record tracks generated from a `fusionRadarSensor` object contained in the scenario. `fusionRadarSensor` generates detections when you set its `TargetReportFormat` property to 'Detetions' or 'Clustered Detections' and generates tracks when you set its `TargetReportFormat` property to 'Tracks'.

`rec = record(sc, format)` also specifies the format, `format`, of the returned platform orientation.

`rec = record(____, Name, Value)` specifies additional recording quantities using name-value pairs. Enclose each `Name` in quotes.

Input Arguments

sc — Tracking scenario

`trackingScenario` object

Tracking scenario, specified as a `trackingScenario` object.

format — Pose orientation format

'quaternion' (default) | 'rotmat'

Pose orientation format, specified as 'quaternion' or 'rotmat'. When specified as 'quaternion', the `Orientation` field of the platform pose structure is a quaternion. When specified as 'rotmat', the `Orientation` field is a rotation matrix.

Example: 'rotmat'

Data Types: char

Name-Value Pair Arguments

Specify optional comma-separated pairs of `Name`, `Value` arguments. `Name` is the argument name and `Value` is the corresponding value. `Name` must appear inside quotes. You can specify several name and value pair arguments in any order as `Name1, Value1, . . . , NameN, ValueN`.

IncludeEmitters — Enable recording emission information

`false` (default) | `true`

Enable recording emission information, specified as `true` or `false`. When specified as `true`, the `rec` output contains `Emissions`, `EmitterConfigurations`, `EmitterPlatformIDs`, and `CoverageConfig` fields.

IncludeSensors — Enable recording sensor information

`false` (default) | `true`

Enable recording sensor information, specified as `true` or `false`. When specified as `true`, the `rec` output contains `Detections`, `SensorConfiguration`, `SensorPlatformIDs`, and `CoverageConfig` fields.

InitialSeed — Initial random seed for recording

current random seed (default) | positive integer

Initial random seed for recording, specified as a positive integer. If specified as a positive integer, the function assigns this number to the random number generator "Twister" before the recording and resets the random number generator at the end of the recording.

HasOcclusion — Enable occlusion in signal transmission

`true` (default) | `false`

Enable occlusion in signal transmission, specified as `true` or `false`. When specified as `true`, the function accounts for the effect of occlusion in radar emission propagation.

RecordingFormat — Format of recording

'Struct' (default) | 'Recording'

Format of recording, specified as 'Struct' or 'Recording'. When specified as 'Struct', the `rec` output is an array of structures. When specified as 'Recording', the `rec` output is a `trackingScenarioRecording` object.

CoordinateSystem — Coordinate system to report recorded poses

'Cartesian' (default) | 'Geodetic'

Coordinate system to report recorded positions, specified as:

- 'Cartesian' — Report recorded poses using Cartesian coordinates in the Earth-Centered-Earth-Fixed coordinate frame.
- 'Geodetic' — Report recorded positions using geodetic coordinates (latitude, longitude, and altitude). Report recorded orientation, velocity, and acceleration in the local reference frame of each platform (North-East-Down by default) corresponding to the current waypoint.

You can only use this argument when the `IsEarthCentered` property of the tracking scenario, `sc`, is set to `true`.

Output Arguments

rec — Records of platform states during simulation

M-by-1 array of structures | `trackingScenarioRecording` object

Records of platform states during the simulation, returned as an *M*-by-1 array of structures if the `RecordingFormat` is specified as 'struct' (default), or a `trackingScenarioRecording` object if the `RecordingFormat` is specified as 'Recording'. *M* is the number of time steps in the simulation.

Each record contains the simulation time step and the recorded information at that time. The record structure has at least two fields: `SimulationTime` and `Poses`. It can also have other optional fields depending on the input.

The `SimulationTime` field contains the simulation time of the record. `Poses` is an *N*-by-1 array of structures, where *N* is the number of platforms. Each `Poses` structure contains these fields:

Field	Description
<code>PlatformID</code>	Unique identifier for the platform, specified as a positive integer. This is a required field with no default value.
<code>ClassID</code>	User-defined integer used to classify the type of target, specified as a nonnegative integer. Zero is reserved for unclassified platform types and is the default value.
<code>Position</code>	Position of target in scenario coordinates, specified as a real-valued 1-by-3 row vector. <ul style="list-style-type: none"> If the <code>coordinateSystem</code> argument is specified as 'Cartesian', the <code>Position</code> is the 3-element Cartesian position coordinates in meters. If the <code>coordinateSystem</code> argument is specified as 'Geodetic', the <code>Position</code> is the 3-element geodetic coordinates: latitude in degrees, longitude in degrees, and altitude in meters.
<code>Velocity</code>	Velocity of platform in scenario coordinates, specified as a real-valued 1-by-3 row vector. units are meters per second. The default value is <code>[0 0 0]</code> .
<code>Acceleration</code>	Acceleration of the platform in scenario coordinates, specified as a 1-by-3 row vector in meters per second squared. The default value is <code>[0 0 0]</code> .

Field	Description
Orientation	Orientation of the platform with respect to the local scenario navigation frame, specified as a scalar quaternion or a 3-by-3 rotation matrix. Orientation defines the frame rotation from the local navigation coordinate system to the current platform body coordinate system. Units are dimensionless. The default value is quaternion(1,0,0,0).
AngularVelocity	Angular velocity of the platform in scenario coordinates, specified as a real-valued 1-by-3 vector. The magnitude of the vector defines the angular speed. The direction defines the axis of clockwise rotation. units are degrees per second. The default value is [0 0 0].

The optional fields in the rec output are:

Field	Description
Emissions	a cell array of emissions (such as radarEmission and sonarEmission) in the scenario
EmitterConfigurations	a struct array of emitter configurations for each emitter
EmitterPlatformIDs	a numeric array of platform IDs for each emitter
Detections	a cell array of objectDetection objects generated by the sensors in the scenario
SensorConfigurations	a struct array of sensor configurations for each sensor
SensorPlatformIDs	a numeric array of platform IDs for each sensor
CoverageConfig	a struct array of coverage configurations for each sensor or emitter

Each emitter configuration structure contains the following fields:

Field	Description
EmitterIndex	Unique emitter index, returned as a positive integer.
IsValidTime	Valid emission time, returned as 0 or 1. IsValidTime is 0 when emitter updates are requested at times that are between update intervals specified by the UpdateInterval property.
IsScanDone	Whether the emitter has completed a scan, returned as true or false.
FieldOfView	Field of view of the emitter, returned as a two-element vector [azimuth; elevation] in degrees.

MeasurementParameters	Emitter measurement parameters, returned as an array of structures containing the coordinate frame transforms needed to transform positions and velocities in the top-level frame to the current emitter frame.
-----------------------	---

Each sensor configuration structure contains the following fields:

Field	Description
SensorIndex	Unique sensor index, returned as a positive integer.
IsValidTime	Valid detection time, returned as <code>true</code> or <code>false</code> . <code>IsValidTime</code> is <code>false</code> when detection updates are requested between update intervals specified by the update rate.
IsScanDone	<code>IsScanDone</code> is <code>true</code> when the sensor has completed a scan.
FieldOfView	Field of view of the sensor, returned as a 2-by-1 vector of positive real values, [<code>azfov</code> ; <code>elfov</code>]. <code>azfov</code> and <code>elfov</code> represent the field of view in azimuth and elevation, respectively.
MeasurementParameters	Sensor measurement parameters, returned as an array of structures containing the coordinate frame transforms needed to transform positions and velocities in the top-level frame to the current sensor frame.

Each coverage configuration structure contains these fields:

Fields of configurations

Field	Description
Index	A unique integer to distinguish sensors or emitters.
LookAngle	The current boresight angles of the sensor or emitter, specified as: <ul style="list-style-type: none"> • A scalar in degrees if scanning only in the azimuth direction. • A two-element vector [azimuth; elevation] in degrees if scanning both in the azimuth and elevation directions.
FieldOfView	The field of view of the sensor or emitter, specified as a two-element vector [azimuth; elevation] in degrees.
ScanLimits	The minimum and maximum angles the sensor or emitter can scan from its Orientation. <ul style="list-style-type: none"> • If the sensor or emitter can only scan in the azimuth direction, specify the limits as a 1-by-2 row vector [minAz, maxAz] in degrees. • If the sensor or emitter can also scan in the elevation direction, specify the limits as a 2-by-2 matrix [minAz, maxAz; minEl, maxEl] in degrees.
Range	The range of the beam and coverage area of the sensor or emitter in meters.
Position	The origin position of the sensor or emitter, specified as a three-element vector [X, Y, Z] on the theater plot's axes.
Orientation	The rotation transformation from the scenario or global frame to the sensor or emitter mounting frame, specified as a rotation matrix, a quaternion, or three Euler angles in ZYX sequence.

Examples

Record a Tracking Scenario

Create a new scenario and add a platform.

```
scene = trackingScenario;
plat = platform(scene);
```

Specify the platform trajectory. The distance of the trajectory is 25 meters. The trajectory velocity is 20 m/s in the x-direction.

```
plat.Trajectory = waypointTrajectory('Waypoints',[0 0 0; 25 0 0], ...  
    'TimeOfArrival', [0 25/20]);
```

Run simulation and record results.

```
r = record(scene)
```

```
r=13x1 struct array with fields:  
    SimulationTime  
    Poses
```

Show the record at the initial time.

```
r(1)
```

```
ans = struct with fields:  
    SimulationTime: 0  
    Poses: [1x1 struct]
```

```
r(1).Poses
```

```
ans = struct with fields:  
    PlatformID: 1  
    ClassID: 0  
    Position: [0 0 0]  
    Velocity: [20 0 0]  
    Acceleration: [0 0 0]  
    Orientation: [1x1 quaternion]  
    AngularVelocity: [0 0 0]
```

Show the record at the final time.

```
r(end)
```

```
ans = struct with fields:  
    SimulationTime: 1.2000  
    Poses: [1x1 struct]
```

```
r(end).Poses
```

```
ans = struct with fields:  
    PlatformID: 1  
    ClassID: 0  
    Position: [24 0 0]  
    Velocity: [20 0 0]  
    Acceleration: [0 0 0]  
    Orientation: [1x1 quaternion]  
    AngularVelocity: [0 0 0]
```

Load and Record Tracking Scenario

Load an air traffic control tracking scenario.

```
load ATCSscenario scenario
```

Run simulation and record results.

```
r = record(scenario, 'quaternion', 'IncludeEmitters', true, ...
    'IncludeSensors', true, 'InitialSeed', 2019)
```

```
r=3215x1 struct array with fields:
    SimulationTime
    Poses
    Emissions
    EmitterConfigurations
    EmitterPlatformIDs
    Detections
    PointClouds
    PointCloudClusters
    SensorConfigurations
    SensorPlatformIDs
    CoverageConfig
```

Show the record at the initial time.

```
r(1)
```

```
ans = struct with fields:
    SimulationTime: 0
    Poses: [4x1 struct]
    Emissions: {0x1 cell}
    EmitterConfigurations: [0x1 struct]
    EmitterPlatformIDs: [0x1 double]
    Detections: {0x1 cell}
    PointClouds: {0x1 cell}
    PointCloudClusters: {0x1 cell}
    SensorConfigurations: [1x1 struct]
    SensorPlatformIDs: 1
    CoverageConfig: [1x1 struct]
```

Show the record at the final time.

```
r(end)
```

```
ans = struct with fields:
    SimulationTime: 59.9947
    Poses: [4x1 struct]
    Emissions: {0x1 cell}
    EmitterConfigurations: [0x1 struct]
    EmitterPlatformIDs: [0x1 double]
    Detections: {0x1 cell}
    PointClouds: {0x1 cell}
    PointCloudClusters: {0x1 cell}
    SensorConfigurations: [1x1 struct]
    SensorPlatformIDs: 1
    CoverageConfig: [1x1 struct]
```

See Also

trackingScenario | trackingScenarioRecording

Introduced in R2018b

restart

Restart tracking scenario simulation

Syntax

```
restart(sc)
```

Description

`restart(sc)` restarts the simulation of the tracking scenario, `sc`, from the beginning and sets the `SimulationTime` property of `sc` to zero.

Input Arguments

sc — Tracking scenario
`trackingScenario` object

Tracking scenario, specified as a `trackingScenario` object.

Introduced in R2018b

trackingScenarioRecording

Tracking scenario recording

Description

Use the trackingScenarioRecording object to record a tracking scenario.

Creation

Syntax

```
TSR = trackingScenarioRecording(recordedData)  
TSR = trackingScenarioRecording(recordedData,Name,Value)
```

Description

TSR = trackingScenarioRecording(recordedData) returns a trackingScenarioRecording object TSR using the recorded data. recordedData sets the value of the RecordedData property.

TSR = trackingScenarioRecording(recordedData,Name,Value) sets properties using one or more name-value pairs. Enclose each property name in quotes.

Input Arguments

recordedData — Recorded data
structure

Recorded data, specified as a structure. The fields of the structure are the same as the fields of the output of the record method of trackingScenario.

Properties

RecordedData — Recorded data stored in the recording object
structure

Recorded data stored in the recording object, specified as a structure. You can set this property only when creating the object. The fields of the structure are the same as the fields of the output of the record method of trackingScenario.

CurrentTime — Timestamp of latest read data
0 | nonnegative scalar

Timestamp of the latest read data, specified as a nonnegative scalar. When you use the read method on the object, the method reads the recorded dataset that has SimulationTime larger than the CurrentTime.

CurrentStep — Step index of the latest read data

0 | nonnegative integer

Step index of the latest read data, specified as a nonnegative integer. When you use the read method on the object, the method reads the next-step dataset.

Object Functions

read Read recorded data
isDone End-of-data status

Examples**Run a Recorded Scenario**

Load recorded data from a prerecorded scenario called recordedScenario. Construct a trackingScenarioRecording object using the recorded data.

```
load recordedData
recording = trackingScenarioRecording(recordedData);
```

Construct a theater plot to display the recorded data using multiple plotters.

```
tp = theaterPlot('AxesUnits', ["km" "km" "km"], 'XLimits', [-50 50]*1e3, ...
    'YLimits', [-50 50]*1e3, 'ZLimits', [-20 20]*1e3);
to = platformPlotter(tp, 'DisplayName', 'Tower', 'Marker', 'd');
pp = platformPlotter(tp, 'DisplayName', 'Targets');
dp = detectionPlotter(tp, 'DisplayName', 'Detections', 'MarkerFaceColor', 'black');
cp = coveragePlotter(tp, 'DisplayName', 'Radar Beam');
```

```
coverage = struct('Index', 1, 'LookAngle', [0; -7], 'FieldOfView', [1; 10], ...
    'ScanLimits', [0 365; -12 -2], 'Range', 100e3, 'Position', [0; 0; -15], ...
    'Orientation', eye(3));
```

Run the recorded scenario and animate the results.

```
scanBuffer = {};
while ~isDone(recording)
    % Step the reader to read the next frame of data
    [simTime, poses, covcon, dets, senconfig] = read(recording);
    scanBuffer = [scanBuffer; dets]; %#ok<AGROW>
    plotPlatform(to, poses(1).Position);
    plotPlatform(pp, reshape([poses(2:4).Position]', 3, []));
    plotCoverage(cp, covcon);
    if ~isempty(dets)
        plotDetection(dp, cell2mat(cellfun(@(c) c.Measurement(:)', scanBuffer, 'UniformOutput', false)));
    end

    % Clear the buffer when a 360 degree scan is complete
    if senconfig.IsScanDone
        scanBuffer = {};
        dp.clearData;
    end
end
```

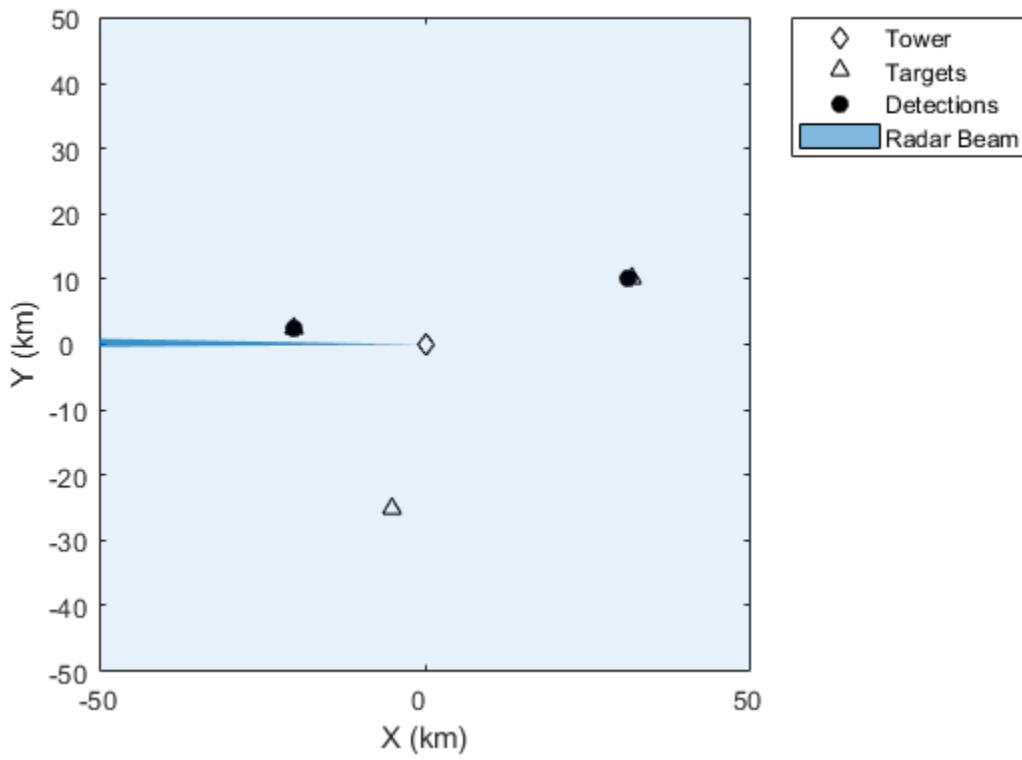

See Also

record | trackingScenario

Introduced in R2020a

read

Read recorded data

Syntax

```
[simTime,poses,detections,sensorConfigs,sensorPlatformIDs,emissions,emitterConfigs,emitterPlatformIDs] = read(TSR)
```

Description

[simTime,poses,detections,sensorConfigs,sensorPlatformIDs,emissions,emitterConfigs,emitterPlatformIDs] = read(TSR) returns one recorded dataset at the simulation time, simTime, from a tracking scenario recording TSR.

Examples

Run a Recorded Scenario

Load recorded data from a prerecorded scenario called recordedScenario. Construct a trackingScenarioRecording object using the recorded data.

```
load recordedData
recording = trackingScenarioRecording(recordedData);
```

Construct a theater plot to display the recorded data using multiple plotters.

```
tp = theaterPlot('AxesUnits', ["km" "km" "km"], 'XLimits', [-50 50]*1e3, ...
    'YLimits', [-50 50]*1e3, 'ZLimits', [-20 20]*1e3);
to = platformPlotter(tp, 'DisplayName', 'Tower', 'Marker', 'd');
pp = platformPlotter(tp, 'DisplayName', 'Targets');
dp = detectionPlotter(tp, 'DisplayName', 'Detections', 'MarkerFaceColor', 'black');
cp = coveragePlotter(tp, 'DisplayName', 'Radar Beam');
```

```
coverage = struct('Index', 1, 'LookAngle', [0; -7], 'FieldOfView', [1; 10], ...
    'ScanLimits', [0 365; -12 -2], 'Range', 100e3, 'Position', [0; 0; -15], ...
    'Orientation', eye(3));
```

Run the recorded scenario and animate the results.

```
scanBuffer = {};
while ~isDone(recording)
    % Step the reader to read the next frame of data
    [simTime,poses,covcon,dets,senconfig] = read(recording);
    scanBuffer = [scanBuffer;dets]; %#ok<AGROW>
    plotPlatform(to,poses(1).Position);
    plotPlatform(pp,reshape([poses(2:4).Position]',3,[]));
    plotCoverage(cp,covcon);
    if ~isempty(dets)
        plotDetection(dp,cell2mat(cellfun(@(c) c.Measurement(:)', scanBuffer, 'UniformOutput', f
    end
end
```

```

% Clear the buffer when a 360 degree scan is complete
if senconfig.IsScanDone
    scanBuffer = {};
    dp.clearData;
end
end
end

```

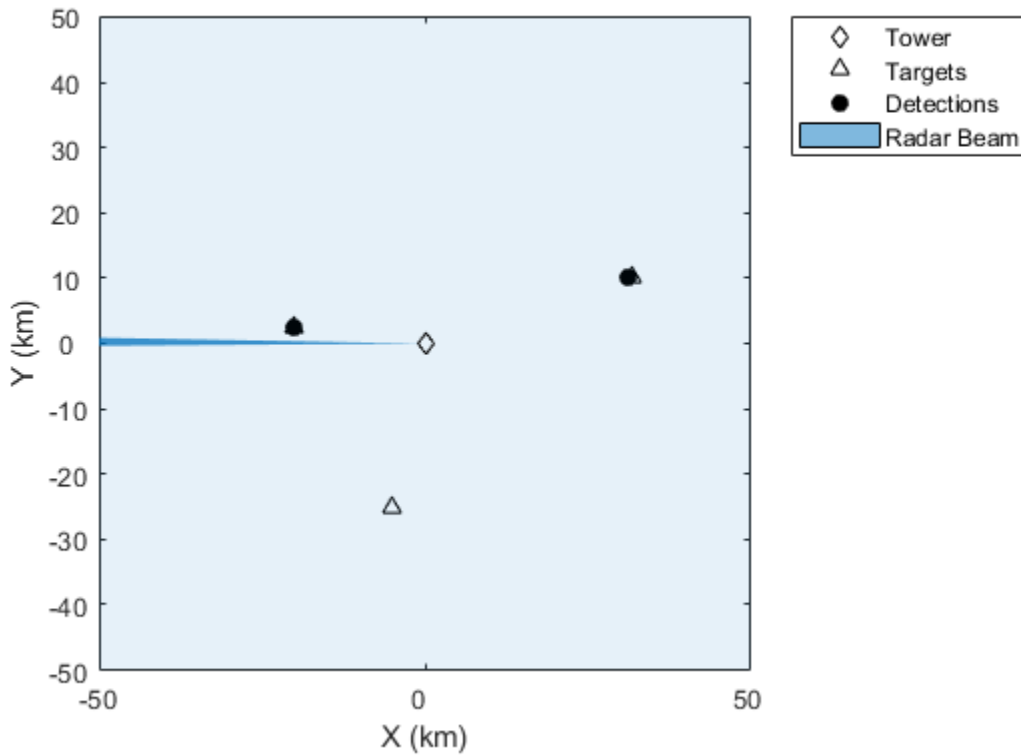

Input Arguments

TSR — Tracking scenario recording

trackingScenarioRecording object

Tracking scenario recording, specified as a trackingScenarioRecording object.

Output Arguments

simTime — Simulation time

nonnegative scalar

Simulation time, returned as a nonnegative scalar.

poses — Poses of platforms

array of structures

Poses of platforms, returned as an array of structures. The fields of each structure are:

Field	Description
PlatformID	Unique identifier for the platform, specified as a positive integer. This is a required field with no default value.
ClassID	User-defined integer used to classify the type of target, specified as a nonnegative integer. Zero is reserved for unclassified platform types and is the default value.
Position	Position of target in scenario coordinates, specified as a real-valued 1-by-3 row vector. <ul style="list-style-type: none"> If the <code>coordinateSystem</code> argument is specified as 'Cartesian', the <code>Position</code> is the 3-element Cartesian position coordinates in meters. If the <code>coordinateSystem</code> argument is specified as 'Geodetic', the <code>Position</code> is the 3-element geodetic coordinates: latitude in degrees, longitude in degrees, and altitude in meters.
Velocity	Velocity of platform in scenario coordinates, specified as a real-valued 1-by-3 row vector. units are meters per second. The default value is [0 0 0].
Acceleration	Acceleration of the platform in scenario coordinates, specified as a 1-by-3 row vector in meters per second squared. The default value is [0 0 0].
Orientation	Orientation of the platform with respect to the local scenario navigation frame, specified as a scalar quaternion or a 3-by-3 rotation matrix. Orientation defines the frame rotation from the local navigation coordinate system to the current platform body coordinate system. Units are dimensionless. The default value is <code>quaternion(1,0,0,0)</code> .
AngularVelocity	Angular velocity of the platform in scenario coordinates, specified as a real-valued 1-by-3 vector. The magnitude of the vector defines the angular speed. The direction defines the axis of clockwise rotation. units are degrees per second. The default value is [0 0 0].

detections — Detections

cell array of `objectDetection` objects

Detections, returned as a cell array of `objectDetection` objects.

sensorConfigs — Sensor configurations

array of structures

Sensor configurations, returned as an array of structures. The fields of each structure are:

Field	Description
SensorIndex	Unique sensor index, returned as a positive integer.
IsValidTime	Valid detection time, returned as <code>true</code> or <code>false</code> . <code>IsValidTime</code> is <code>false</code> when detection updates are requested between update intervals specified by the update rate.
IsScanDone	<code>IsScanDone</code> is <code>true</code> when the sensor has completed a scan.
FieldOfView	Field of view of the sensor, returned as a 2-by-1 vector of positive real values, [<code>azfov</code> ; <code>elfov</code>]. <code>azfov</code> and <code>elfov</code> represent the field of view in azimuth and elevation, respectively.
MeasurementParameters	Sensor measurement parameters, returned as an array of structures containing the coordinate frame transforms needed to transform positions and velocities in the top-level frame to the current sensor frame.

sensorPlatformIDs — Platform IDs of sensors

array of nonnegative integers

Platform IDs of sensors, returned as an array of nonnegative integers.

emissions — Emissions

cell array of `radarEmission` or `sonarEmission` objects

Emissions, returned as a cell array of `radarEmission` or `sonarEmission` objects.

emitterConfigs — Emitter configurations

array of structures

Emitter configurations, returned as an array of structures. The fields of each structure are:

Field	Description
EmitterIndex	Unique emitter index, returned as a positive integer.
IsValidTime	Valid emission time, returned as 0 or 1. <code>IsValidTime</code> is 0 when emitter updates are requested at times that are between update intervals specified by the <code>UpdateInterval</code> property.
IsScanDone	Whether the emitter has completed a scan, returned as <code>true</code> or <code>false</code> .
FieldOfView	Field of view of the emitter, returned as a two-element vector [<code>azimuth</code> ; <code>elevation</code>] in degrees.

MeasurementParameters	Emitter measurement parameters, returned as an array of structures containing the coordinate frame transforms needed to transform positions and velocities in the top-level frame to the current emitter frame.
-----------------------	---

emitterPlatformIDs — Platform IDs of emitters

array of nonnegative integers

Platform IDs of emitters, returned as an array of nonnegative integers.

See Also

record | trackingScenario | trackingScenarioRecording

Introduced in R2020a

coverageConfig

Sensor and emitter coverage configuration

Syntax

```
configs = coverageConfig(sc)
configs = coverageConfig(sensors)
configs = coverageConfig(sensors,positions,orientations)
```

Description

`configs = coverageConfig(sc)` returns sensor coverage configuration structures in a tracking scenario `sc`.

`configs = coverageConfig(sensors)` returns sensor coverage configuration structures from a list of sensors and emitters.

`configs = coverageConfig(sensors,positions,orientations)` allows you to specify the position and orientation of the platform on which each sensor or emitter is mounted.

Examples

Obtain Coverage Configuration

Create a radar sensor and a radar emitter.

```
radar = monostaticRadarSensor(1,'Rotator');
emitter = radarEmitter(2);
```

Obtain coverage configurations based on sensor's position information.

```
cfg = coverageConfig({radar, emitter})
```

cfg=2×1 struct array with fields:

```
Index
LookAngle
FieldOfView
ScanLimits
Range
Position
Orientation
```

```
cfg2 = coverageConfig({radar, emitter},[1000 0 0 ; 0 1000 0])
```

cfg2=2×1 struct array with fields:

```
Index
LookAngle
FieldOfView
ScanLimits
Range
```

Position
Orientation

Input Arguments

sc — Tracking scenario

trackingScenario object

Tracking scenario, specified as a trackingScenario object.

sensors — Sensors or emitters

sensor or emitter object | N -element cell array of sensor or emitter object

Sensors or emitters, specified as a sensor or emitter object, or an N -element cell array of sensor or emitter objects, where N is the number of sensor or emitter objects. The applicable sensor or emitter objects include fusionRadarSensor, radarEmitter, sonarSensor, sonarEmitter, irSensor, and monostaticLidarSensor.

positions — Position of sensor or emitter's platform

N -by-3 matrix of scalar

Position of sensor or emitter's platform, specified as an N -by-3 matrix of scalars. The i th row of the matrix is the $[x, y, z]$ Cartesian coordinates of the i th sensor or emitter's platform.

orientations — Orientation of sensor or emitter's platform

N -by-1 vector of quaternion

Orientation of sensor or emitter's platform, specified as an N -by-1 vector of quaternions. The i th quaternion in the vector represents the rotation from the global or scenario frame to the i th sensor or emitter's platform frame.

Output Arguments

configs — Sensor or emitter coverage configurations

N -element array of configuration structure

Sensor or emitter coverage configurations, returned as an N -element array of configuration structures. N is the number of sensor or emitter objects specified in the sensors input. Each configuration structure contains seven fields:

Fields of configurations

Field	Description
Index	A unique integer to distinguish sensors or emitters.
LookAngle	The current boresight angles of the sensor or emitter, specified as: <ul style="list-style-type: none"> • A scalar in degrees if scanning only in the azimuth direction. • A two-element vector [azimuth; elevation] in degrees if scanning both in the azimuth and elevation directions.
FieldOfView	The field of view of the sensor or emitter, specified as a two-element vector [azimuth; elevation] in degrees.
ScanLimits	The minimum and maximum angles the sensor or emitter can scan from its Orientation. <ul style="list-style-type: none"> • If the sensor or emitter can only scan in the azimuth direction, specify the limits as a 1-by-2 row vector [minAz, maxAz] in degrees. • If the sensor or emitter can also scan in the elevation direction, specify the limits as a 2-by-2 matrix [minAz, maxAz; minEl, maxEl] in degrees.
Range	The range of the beam and coverage area of the sensor or emitter in meters.
Position	The origin position of the sensor or emitter, specified as a three-element vector [X, Y, Z] on the theater plot's axes.
Orientation	The rotation transformation from the scenario or global frame to the sensor or emitter mounting frame, specified as a rotation matrix, a quaternion, or three Euler angles in ZYX sequence.

You can use configs to plot the sensor coverage in a theaterPlot using its plotCoverage object function.

Note The Index field is returned as a positive integer if the input is a sensor object, such as a fusionRadarSensor object. The Index field is returned as negative integer if the input is an emitter object, such as a radarEmitter object.

See Also

coveragePlotter | plotCoverage | trackingScenario

Introduced in R2020a

tsSignature

Target strength pattern

Description

`tsSignature` creates a sonar target strength (TS) signature object. You can use this object to model an angle-dependent and frequency-dependent target strength pattern. Target strength determines the intensity of reflected sound signal power from a target.

Creation

Syntax

```
tssig = tsSignature
tssig = tsSignature(Name, Value)
```

Description

`tssig = tsSignature` creates a `tsSignature` object with default property values.

`tssig = tsSignature(Name, Value)` sets object properties using one or more `Name, Value` pair arguments. `Name` is a property name and `Value` is the corresponding value. `Name` must appear inside single quotes (`' '`). You can specify several name-value pair arguments in any order as `Name1, Value1, ..., NameN, ValueN`. Any unspecified properties take default values.

Note You can only set property values of `tsSignature` when constructing the object. The property values are not changeable after construction.

Properties

Pattern — Target strength pattern

`[-30 -30; -30 -30]` (default) | *Q*-by-*P* real-valued matrix | *Q*-by-*P*-by-*K* real-valued array

Sampled target strength pattern, specified as a scalar, a *Q*-by-*P* real-valued matrix, or a *Q*-by-*P*-by-*K* real-valued array. The pattern is an array of TS values defined on a grid of elevation angles, azimuth angles, and frequencies. Azimuth and elevation are defined in the body frame of the target.

- *Q* is the number of TS samples in elevation.
- *P* is the number of TS samples in azimuth.
- *K* is the number of TS samples in frequency.

Q, *P*, and *K* usually match the length of the vectors defined in the `Elevation`, `Azimuth`, and `Frequency` properties, respectively, with these exceptions:

- To model a TS pattern for an elevation cut (constant azimuth), you can specify the TS pattern as a Q -by-1 vector or a 1-by- Q -by- K matrix. Then, the elevation vector specified in the `Elevation` property must have length 2.
- To model a TS pattern for an azimuth cut (constant elevation), you can specify the TS pattern as a 1-by- P vector or a 1-by- P -by- K matrix. Then, the azimuth vector specified in the `Azimuth` property must have length 2.
- To model a TS pattern for one frequency, you can specify the TS pattern as a Q -by- P matrix. Then, the frequency vector specified in the `Frequency` property must have length 2.

Example: [10,0;0,-5]

Data Types: double

Azimuth — Azimuth angles

[-180 180] (default) | length- P real-valued vector

Azimuth angles used to define the angular coordinates of each column of the matrix or array specified by the `Pattern` property. Specify the azimuth angles as a length- P vector. P must be greater than two. Angle units are in degrees.

Example: [-45:0.1:45]

Data Types: double

Elevation — Elevation angles

[-90 90] (default) | length- Q real-valued vector

Elevation angles used to define the coordinates of each row of the matrix or array specified by the `Pattern` property. Specify the elevation angles as a length- Q vector. Q must be greater than two. Angle units are in degrees.

Example: [-30:0.1:30]

Data Types: double

Frequency — Pattern frequencies

[0 1e8] (default) | K -element vector of positive scalars

Frequencies used to define the applicable target strength for each page of the `Pattern` property, specified as a K -element vector of positive scalars. K is the number of TS samples in frequency. K must be no less than two. Frequency units are in hertz.

Example: [0:0.1:30]

Data Types: double

Object Functions

value Target strength at specified angle and frequency
toStruct Convert to structure

Examples

Target Strength of Rigid Cylinder

Specify the target strength (TS) of a 5m long rigid cylinder immersed in water and plot TS values along an azimuth cut. Assume the short-wavelength approximation. The cylinder radius is 2m. The speed of sound is 1520 m/s.

```
L = 5;  
a = 2;
```

Create an array of target strengths at two wavelengths. First, specify the range of azimuth and elevation angles over which TS is defined. Then, use an analytical model to compute the target strength. Create an image of the TS.

```
lambda = [0.12, .1];  
c = 1520.0;  
az = [-20:0.1:20];  
el = [-10:0.1:10];  
ts1 = ts_cylinder(L,a,az,el,lambda(1));  
ts2 = ts_cylinder(L,a,az,el,lambda(2));  
tsdb1 = 10*log10(ts1);  
tsdb2 = 10*log10(ts2);  
imagesc(az,el,tsdb1)  
title('Target Strength')  
xlabel('Azimuth (deg)')  
ylabel('Elevation (deg)')  
colorbar
```

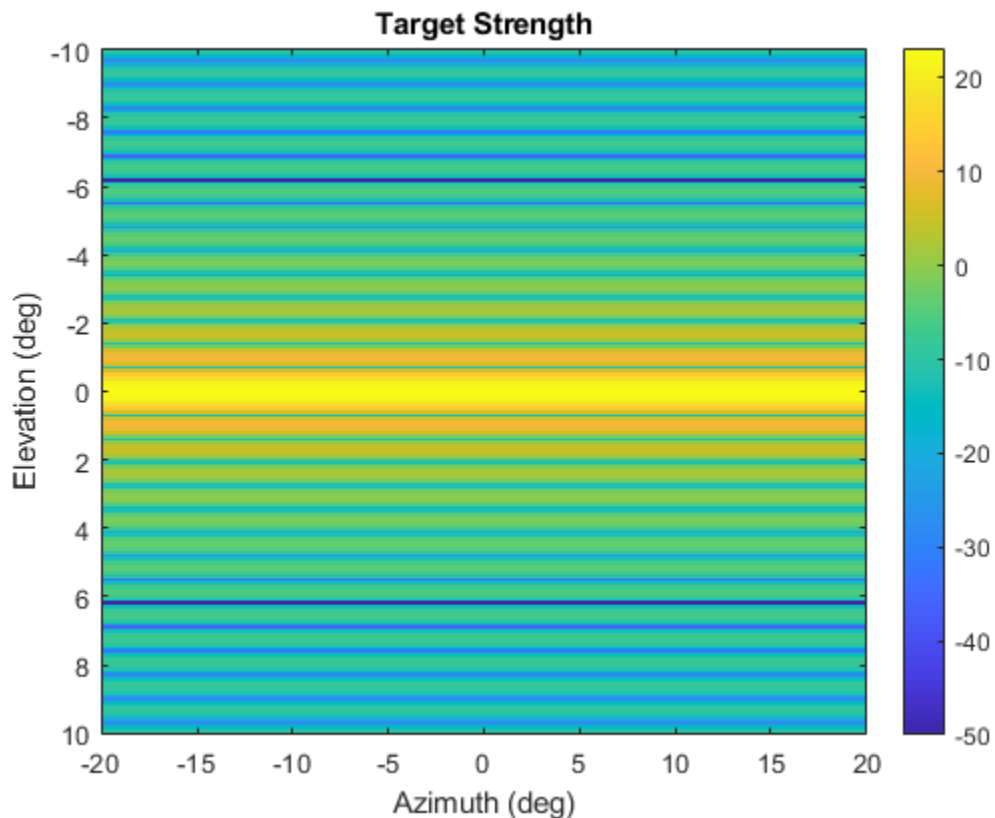

Create a tsSignature object and plot an elevation cut at 30° azimuth.

```
tsdb(:,:,1) = tsdb1;
tsdb(:,:,2) = tsdb2;
freq = c./lambda;
tssig = tsSignature('Pattern',tsdb,'Azimuth',az,'Elevation',el,'Frequency',freq);
ts = value(tssig,30,el,freq(1));
plot(el,tsdb1)
grid
title('Elevation Profile of Target Strength')
xlabel('Elevation (deg)')
ylabel('TS (dBsm)')
```

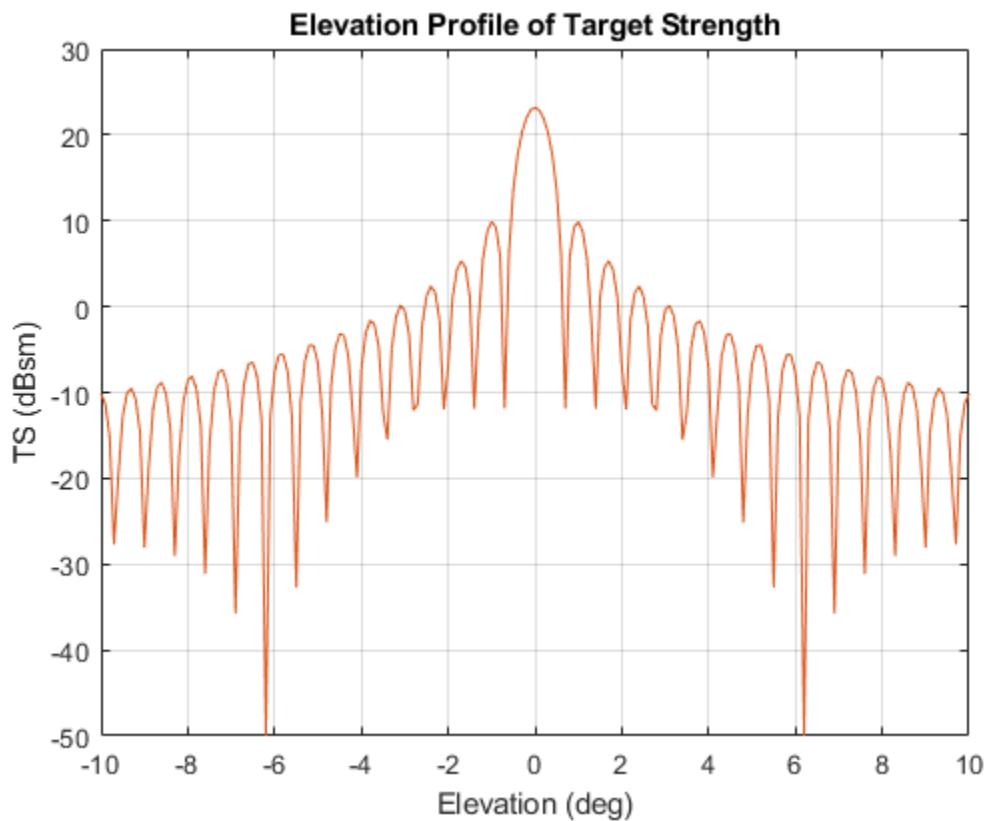

```
function ts = ts_cylinder(L,a,az,el,lambda)
k = 2*pi/lambda;
beta = k*L*sind(el')*ones(size(az));
gamma = cosd(el')*ones(size(az));
ts = a*L^2*(sinc(beta).^2).*gamma.^2/2/lambda;
ts = max(ts,10^(-5));
end
```

```
function s = sinc(theta)
s = ones(size(theta));
idx = (abs(theta) <= 1e-2);
s(idx) = 1 - 1/6*(theta(idx)).^2;
s(~idx) = sin(theta(~idx))./theta(~idx);
end
```

References

[1] Urich, Robert J. *Principles of Underwater Sound, 3rd ed.* New York: McGraw-Hill, Inc. 2005.

Extended Capabilities

C/C++ Code Generation

Generate C and C++ code using MATLAB® Coder™.

See Also

Classes

`rcsSignature`

Introduced in R2018b

value

Target strength at specified angle and frequency

Syntax

```
t sval = value(tssig,az,el,freq)
```

Description

`t sval = value(tssig,az,el,freq)` returns the value, `t sval`, of the target strength specified by the target strength signature object, `tssig`, computed at azimuth `az`, elevation `el`, and frequency `freq`. If the specified azimuth and elevation is outside of the region in which the target strength signature is defined, the target strength value, `t sval`, is returned as `-Inf` in dBsm.

Input Arguments

tssig — Target strength signature

`tsSignature` object

Target strength signature, specified as a `tsSignature` object.

az — Azimuth angle

scalar | length-*M* real-valued vector

Azimuth angle, specified as scalar or length-*M* real-valued vector. Units are in degrees. The `az`, `el`, and `freq` arguments must have the same size. You can, however, specify one or two arguments as scalars, in which case the arguments are expanded to length-*M*.

Data Types: `double`

el — Elevation angle

scalar | length-*M* real-valued vector

Elevation angle, specified as scalar or length-*M* real-valued vector. The `az`, `el`, and `freq` arguments must have the same size. You can, however, specify one or two arguments as scalars, in which case the arguments are expanded to length-*M*. Units are in degrees.

Data Types: `double`

freq — TS frequency

positive scalar | length-*M* vector with positive, real elements

TS frequency, specified as a positive scalar or length-*M* vector with positive, real elements. The `az`, `el`, and `freq` arguments must have the same size. You can, however, specify one or two arguments as scalars, in which case the arguments are expanded to length-*M*. Units are in Hertz.

Example: `20e3`

Data Types: `double`

Output Arguments

tssval — Target strength

scalar | real-valued length- M vector

Target strength, returned as a scalar or real-valued length- M vector. Units are in dBsm.

Object Functions

perturbations Perturbation defined on object

perturb Apply perturbations to object

Examples

Target Strength of Rigid Cylinder

Specify the target strength (TS) of a 5m long rigid cylinder immersed in water and plot TS values along an azimuth cut. Assume the short-wavelength approximation. The cylinder radius is 2m. The speed of sound is 1520 m/s.

```
L = 5;  
a = 2;
```

Create an array of target strengths at two wavelengths. First, specify the range of azimuth and elevation angles over which TS is defined. Then, use an analytical model to compute the target strength. Create an image of the TS.

```
lambda = [0.12, .1];  
c = 1520.0;  
az = [-20:0.1:20];  
el = [-10:0.1:10];  
ts1 = ts_cylinder(L,a,az,el,lambda(1));  
ts2 = ts_cylinder(L,a,az,el,lambda(2));  
tsdb1 = 10*log10(ts1);  
tsdb2 = 10*log10(ts2);  
imagesc(az,el,tsdb1)  
title('Target Strength')  
xlabel('Azimuth (deg)')  
ylabel('Elevation (deg)')  
colorbar
```

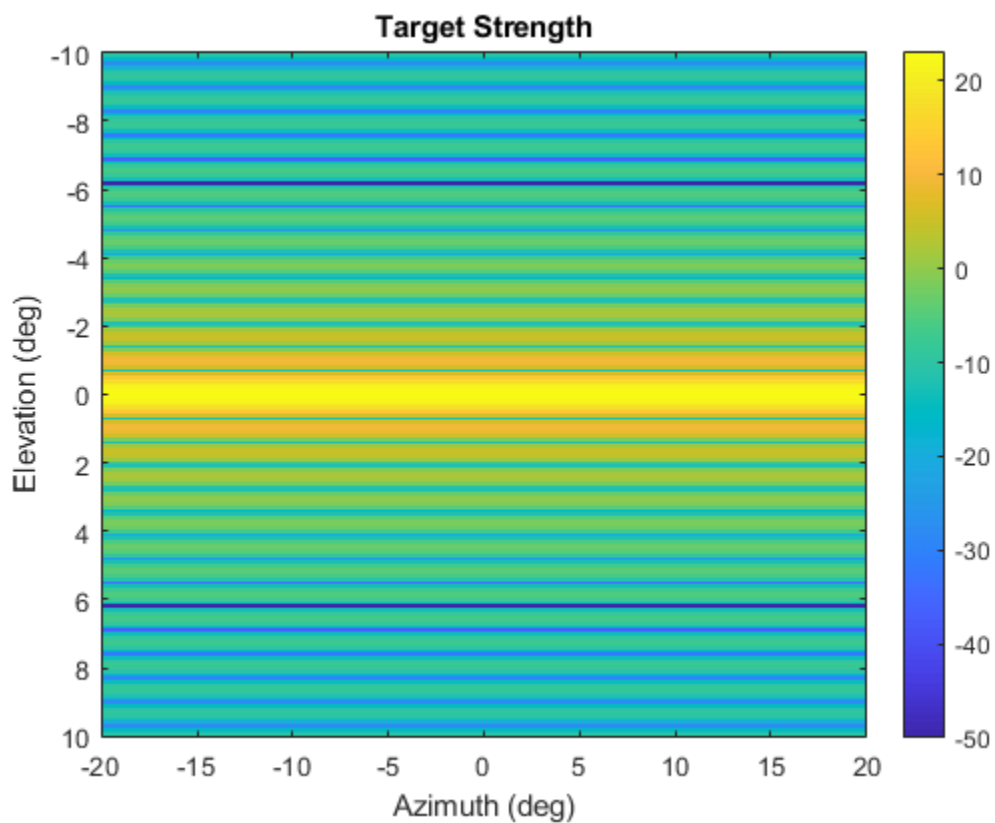

Create a `tsSignature` object and plot an elevation cut at 30° azimuth.

```
tsdb(:,:,1) = tsdb1;
tsdb(:,:,2) = tsdb2;
freq = c./lambda;
tssig = tsSignature('Pattern',tsdb,'Azimuth',az,'Elevation',el,'Frequency',freq);
ts = value(tssig,30,el,freq(1));
plot(el,tsdb1)
grid
title('Elevation Profile of Target Strength')
xlabel('Elevation (deg)')
ylabel('TS (dBsm)')
```

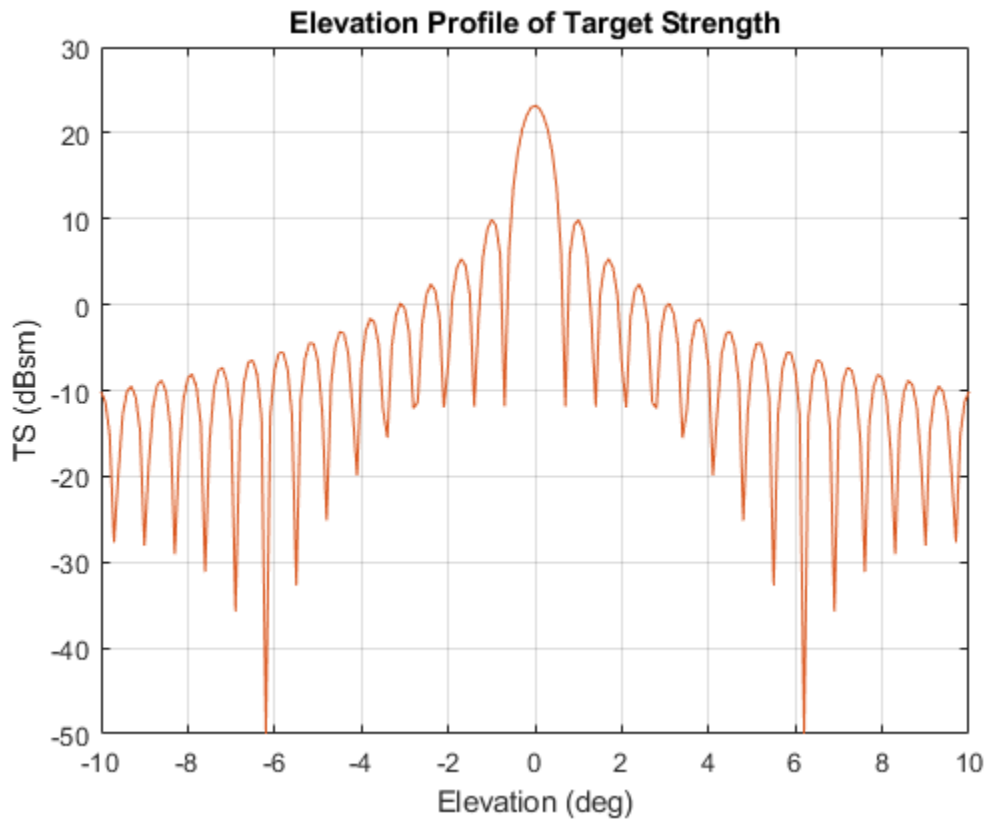

```
function ts = ts_cylinder(L,a,az,el,lambda)
k = 2*pi/lambda;
beta = k*L*sind(el')*ones(size(az));
gamma = cosd(el')*ones(size(az));
ts = a*L^2*(sinc(beta).^2).*gamma.^2/2/lambda;
ts = max(ts,10^(-5));
end
```

```
function s = sinc(theta)
s = ones(size(theta));
idx = (abs(theta) <= 1e-2);
s(idx) = 1 - 1/6*(theta(idx)).^2;
s(~idx) = sin(theta(~idx))./theta(~idx);
end
```

Extended Capabilities

C/C++ Code Generation

Generate C and C++ code using MATLAB® Coder™.

See Also

Introduced in R2018b

toStruct

Convert to structure

Syntax

```
tsStruct = toStruct(tsSig)
```

Description

`tsStruct = toStruct(tsSig)` converts the `tsSignature` object `tsSig` to a structure `tsStruct`. The field names of the returned structure are the same as the property names of the `tsSignature` object.

Examples

Convert tsSignature to Structure

Create a `tsSignature` object.

```
tsSig = tsSignature
```

```
tsSig =  
    tsSignature with properties:  
  
        Pattern: [2x2 double]  
        Azimuth: [-180 180]  
        Elevation: [2x1 double]  
        Frequency: [0 100000000]
```

Convert the signature to a structure.

```
tsStruct = toStruct(tsSig)  
  
tsStruct = struct with fields:  
    Pattern: [2x2 double]  
    Azimuth: [-180 180]  
    Elevation: [2x1 double]  
    Frequency: [0 100000000]
```

Input Arguments

tsSig — TS signature

`tsSignature` object

TS signature, specified as an `tsSignature` object.

Output Arguments

tsStruct — TS structure
structure

TS structure, returned as a structure.

Introduced in R2020b

irSignature

Infrared platform signature

Description

The `irSignature` creates an infrared (IR) signature object. You can use this object to model an angle-dependent contrast radiant intensity of a platform. The radiant intensity is with respect to the background.

Creation

Syntax

```
irsig = irSignature
irsig = irSignature(Name,Value)
```

Description

`irsig = irSignature` creates an `irSignature` object with default property values.

`irsig = irSignature(Name,Value)` sets object properties using one or more `Name, Value` pair arguments. `Name` is a property name and `Value` is the corresponding value. `Name` must appear inside single quotes (`' '`). You can specify several name-value pair arguments in any order as `Name1, Value1, ..., NameN, ValueN`. Any unspecified properties take default values.

Note You can only set property values of `irSignature` when constructing the object. The property values are not changeable after construction.

Properties

Pattern — Sampled IR intensity pattern

[50 50; 50 50] (default) | Q -by- P real-valued matrix

Sampled contrast IR intensity pattern, specified as a scalar, or a Q -by- P real-valued matrix. The pattern is an array of IR values defined on a grid of elevation angles and azimuth angles. Azimuth and elevation are defined in the body frame of the target. Units are dBw/sr.

- Q is the number of IR samples in elevation.
- P is the number of IR samples in azimuth.

Q and P usually match the length of the vectors defined in the `Elevation` and `Azimuth` properties, respectively, with these exceptions:

- If you want to model an IR pattern for an elevation cut (constant azimuth), you can specify the IR pattern as a Q -by-1 vector. Then, the elevation vector specified in the `Elevation` property must have length-2.

- If you want to model an IR pattern for an azimuth cut (constant elevation), you can specify the IR pattern as a 1-by- P vector. Then, the azimuth vector specified in the `Azimuth` property must have length-2.

Example: `[10,0;0,-5]`

Data Types: `double`

Azimuth — Azimuth angles

`[-180 180]` (default) | length- P real-valued vector

Azimuth angles used to define the angular coordinates of each column of the matrix or array specified by the `Pattern` property. Specify the azimuth angles as a length P vector. P must be greater than two. Angle units are in degrees.

Example: `[-45:0.5:45]`

Data Types: `double`

Elevation — Elevation angles

`[-90 90]` (default) | length- Q real-valued vector

Elevation angles used to define the coordinates of each row of the matrix or array specified by the `Pattern` property. Specify the elevation angles as a length Q vector. Q must be greater than two. Angle units are in degrees.

Example: `[-30:0.5:30]`

Data Types: `double`

Frequency — Pattern frequencies

`[0 1e20]` (default) | K -element vector of positive scalars

Frequencies used to define the applicable IR intensity for each page of the `Pattern` property, specified as a K -element vector of positive scalars. K is the number of RCS samples in frequency. K must be no less than two. Frequency units are in hertz.

Example: `[0:0.1:30]`

Data Types: `double`

Object Functions

`value` Infrared intensity at specified angle and frequency
`toStruct` Convert to structure

Examples

Create Direction-Dependent IR Signature

Create and display an IR intensity signature. The signature depends on azimuth and elevation.

Define the azimuth and elevation angle sample points.

```
az = -90:90;  
el = [-30:30];
```

Create the IR intensity signature pattern.

```
pat = 50*cosd(2*el.)*cosd(az).^2;  
irsig = irSignature('Pattern',pat,'Azimuth',az,'Elevation',el);
```

Display the IR pattern.

```
imagesc(irsig.Azimuth,irsig.Elevation,irsig.Pattern)  
xlabel('Azimuth (deg)')  
ylabel('Elevation')  
title('Infrared Signature Pattern (dBw/sr)')
```

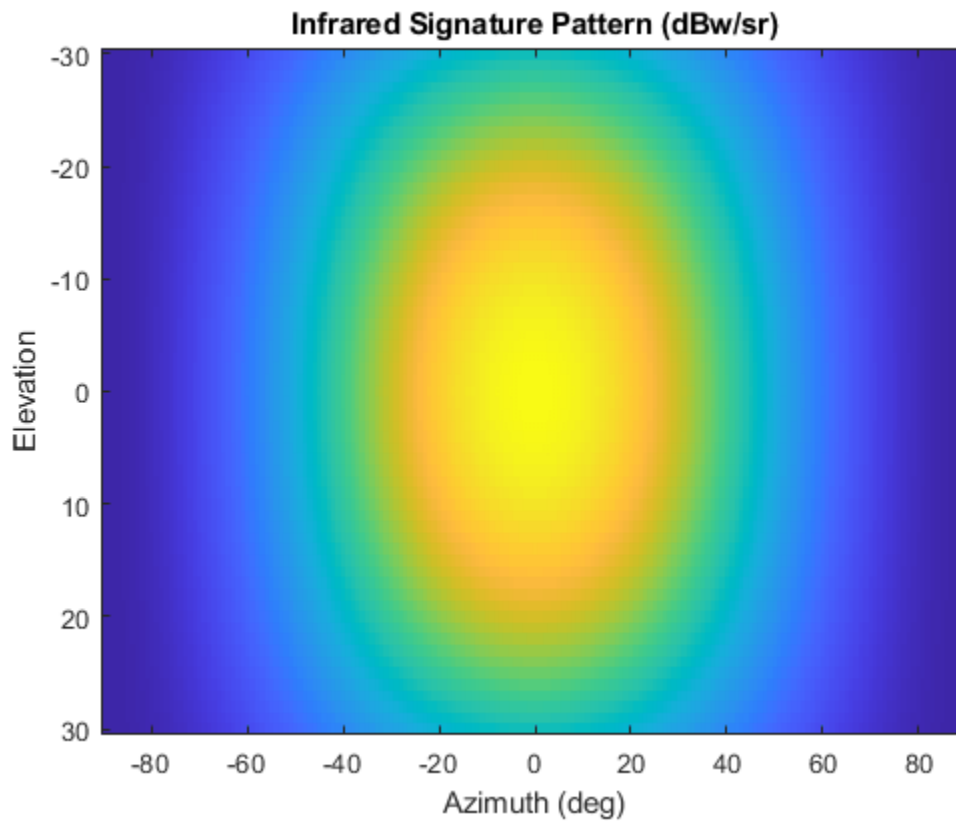

Get the IR intensity value at 25 degrees azimuth and 10 degrees elevation.

```
value(irsig,25,10)
```

```
ans = 38.5929
```

Get IR intensity value outside of the valid elevation span.

```
value(irsig,25,35)
```

```
ans = -Inf
```

Extended Capabilities

C/C++ Code Generation

Generate C and C++ code using MATLAB® Coder™.

See Also

Classes

`rscSignature` | `tsSignature`

Introduced in R2018b

value

Infrared intensity at specified angle and frequency

Syntax

```
irval = value(irsig,az,el)
```

Description

`irval = value(irsig,az,el)` returns the value of the IR intensity, `irval`, specified by the IR signature object, `irsig`, computed at the azimuth, `az`, and elevation, `el`. If the specified azimuth and elevation is outside of the region in which the IR signature is defined, the IR intensity is returned as `-Inf` in dBw/sr.

Input Arguments

irsig – IR signature object

`irSignature` object

Radar cross-section signature, specified as an `irSignature` object.

az – Azimuth angle

scalar | real-valued length-*M* vector

Azimuth angle, specified as scalar or length-*M* real-valued vector. Units are in degrees. The `az`, `el`, and `freq` arguments must have the same size. You can, however, specify one or two arguments as scalars, in which case, the arguments are expanded to length-*M*.

Example: 30

Data Types: `double`

el – Elevation angle

scalar | real-valued length-*M* vector

Elevation angle, specified as scalar or real-valued length-*M* vector. The `az` and `el` arguments must have the same size. You can, however, specify one or two arguments as scalars, in which case, the arguments are expanded to length-*M*. Units are in degrees.

Example: -4

Data Types: `double`

Output Arguments

irval – Infrared intensity

scalar | real-valued length-*M* vector

Infrared intensity, returned as a scalar or real-valued length-*M* vector. Units are in dBw/sr.

Examples

Create Direction-Dependent IR Signature

Create and display an IR intensity signature. The signature depends on azimuth and elevation.

Define the azimuth and elevation angle sample points.

```
az = -90:90;  
el = [-30:30];
```

Create the IR intensity signature pattern.

```
pat = 50*cosd(2*el.)*cosd(az).^2;  
irsig = irSignature('Pattern',pat,'Azimuth',az,'Elevation',el);
```

Display the IR pattern.

```
imagesc(irsig.Azimuth,irsig.Elevation,irsig.Pattern)  
xlabel('Azimuth (deg)')  
ylabel('Elevation')  
title('Infrared Signature Pattern (dBw/sr)')
```

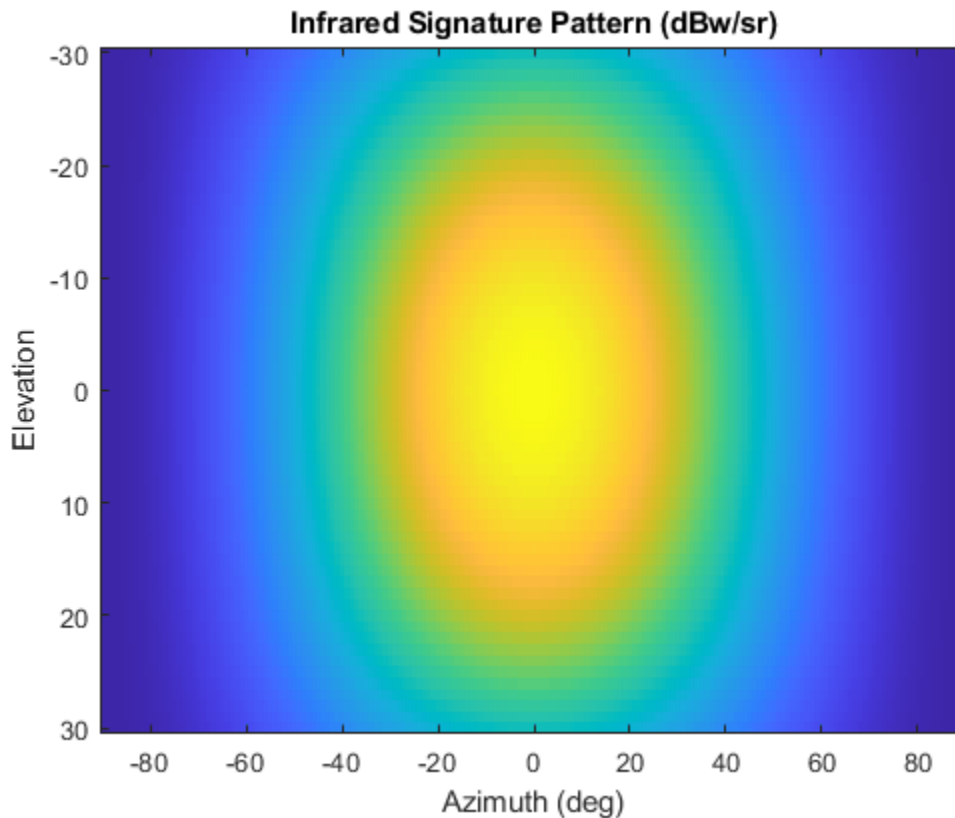

Get the IR intensity value at 25 degrees azimuth and 10 degrees elevation.

```
value(irsig,25,10)
```

```
ans = 38.5929
```

Get IR intensity value outside of the valid elevation span.

```
value(irsig,25,35)
```

```
ans = -Inf
```

Extended Capabilities

C/C++ Code Generation

Generate C and C++ code using MATLAB® Coder™.

See Also

Introduced in R2018b

toStruct

Convert to structure

Syntax

```
irStruct = toStruct(irSig)
```

Description

`irStruct = toStruct(irSig)` converts the `irSignature` object `irSig` to a structure `irStruct`. The field names of the returned structure are the same as the property names of the `irSignature` object.

Examples

Convert irSignature to Structure

Create an `irSignature` object.

```
irSig = irSignature
```

```
irSig =  
    irSignature with properties:  
  
        Pattern: [2x2 double]  
        Azimuth: [-180 180]  
        Elevation: [2x1 double]  
        Frequency: [0 1.0000e+20]
```

Convert the signature to a structure.

```
irStruct = toStruct(irSig)  
  
irStruct = struct with fields:  
        Pattern: [2x2 double]  
        Azimuth: [-180 180]  
        Elevation: [2x1 double]  
        Frequency: [0 1.0000e+20]
```

Input Arguments

irSig — IR signature

`irSignature` object

IR signature, specified as an `irSignature` object.

Output Arguments

irStruct – IR structure
structure

IR structure, returned as a structure.

Introduced in R2020b

tunerconfig

Fusion filter tuner configuration options

Description

The `tunerconfig` object creates a tuner configuration for a fusion filter used to tune the filter for reduced estimation error.

Creation

Syntax

```
config = tunerconfig(filterName)
config = tunerconfig(filterName,Name,Value)
```

Description

`config = tunerconfig(filterName)` creates a `tunerconfig` object controlling the optimization algorithm of the tune function of the fusion filter.

`config = tunerconfig(filterName,Name,Value)` configures the created `tunerconfig` object properties using one or more name-value pair arguments. `Name` is a property name and `Value` is the corresponding value. `Name` must appear inside quotes. You can specify several name-value pair arguments in any order as `Name1,Value1,...,NameN,ValueN`. Any unspecified properties take default values.

For example, `tunerconfig('imufilter','MaxIterations',3)` create a `tunerconfig` object for the `imufilter` object with the a maximum of three allowed iterations.

Inputs Arguments

filterName — Fusion filter name

'imufilter' | 'ahrsfilter' | 'ahrs10filter' | 'insfilterAsync' | 'insfilterMARG' | 'insfitlerErrorState' | 'insfilterNonholonomic'

Fusion filter name, specified as one of these options:

- 'imufilter'
- 'ahrsfilter'
- 'ahrs10filter'
- 'insfilterAsync'
- 'insfilterMARG'
- 'insfitlerErrorState'
- 'insfilterNonholonomic'

Properties

Filter — Class name of filter

string

This property is read-only.

Class name of filter, specified as a string. Its value is one of these strings:

- "imufilter"
- "ahrsfilter"
- "ahrs10filter"
- "insfilterAsync"
- "insfilterMARG"
- "insfilterErrorState"
- "insfilterNonholonomic"

TunableParameters — Tunable parameters

array of string

Tunable parameters, specified as an array of strings. Each string is a tunable property name of the fusion filter. By default, the property contains all the tunable parameters of a fusion filter.

Example: ["AccelerometerNoise" "GyroscopeNoise"]

StepForward — Factor of forward step

1.1 (default) | scalar larger than 1

Factor of a forward step, specified as a scalar larger than 1. During the tuning process, the tuner increases or decreases the noise parameters to achieve smaller estimation errors. This property specifies the ratio of parameter increase during a parameter increase step.

StepBackward — Factor of backward step

0.5 (default) | scalar in range (0,1)

Factor of a backward step, specified as a scalar in the range of (0,1). During the tuning process, the tuner increases or decreases the noise parameters to achieve smaller estimation errors. This property specifies the factor of parameter decrease during a parameter decrease step.

MaxIterations — Maximum number of iterations

20 (default) | positive integer

Maximum number of iterations allowed by the tuning algorithm, specified as a positive integer.

ObjectiveLimit — Cost at which to stop tuning process

0.1 (default) | positive scalar

Cost at which to stop the tuning process, specified as a positive scalar.

FunctionTolerance — Minimum change in cost to continue tuning

0 (default) | nonnegative scalar

Minimum change in cost to continue tuning, specified as a nonnegative scalar. If the change in cost is smaller than the specified tolerance, the tuning process stops.

Display — Enable showing the iteration details`"iter" (default) | "none"`

Enable showing the iteration details, specified as `"iter"` or `"none"`. When specified as:

- `"iter"` — The program shows the tuned parameter details in each iteration in the Command Window.
- `"none"` — The program does not show any tuning information.

Cost — Metric for evaluating filter performance`"RMS" (default) | "Custom"`

Metric for evaluating filter performance, specified as `"RMS"` or `"Custom"`. When specified as:

- `"RMS"` — The program optimizes the root-mean-squared (RMS) error between the estimate and the truth.
- `"Custom"` — The program optimizes the filter performance by using a customized cost function specified by the `CustomCostFcn` property.

CustomCostFcn — Customized cost function`[] (default) | function handle`

Customized cost function, specified as a function handle.

Dependencies

To enable this property, set the `Cost` property to `'Custom'`. See the “Custom Tuning of Fusion Filters” example for details on how to customize a cost function.

OutputFcn — Output function called at each iteration`[] (default) | function handle`

Output function called at each iteration, specified as a function handle. The function must use the following syntax:

```
stop = myOutputFcn(params,tunerValues)
```

`params` is a structure of the current best estimate of each parameter at the end of the current iteration. `tunerValues` is a structure containing information of the tuner configuration, sensor data, and truth data. It has these fields:

Field Name	Description
Iteration	Iteration count of the tuner, specified as a positive integer
SensorData	Sensor data input to the <code>tune</code> function
GroundTruth	Ground truth input to the <code>tune</code> function
Configuration	<code>tunerconfig</code> object used for tuning
Cost	Tuning cost at the end of the current iteration

Tip You can use the built-in function `tunerPlotPose` to visualize the truth data and the estimates for most of your tuning applications. See the “Visualize Tuning Results Using `tunerPlotPose`” on page 1-422 example for details.

Examples

Create Tunerconfig Object and Show Tunable Parameters

Create a tunerconfig object for the insfilterAsync object.

```
config = tunerconfig('insfilterAsync')
```

```
config =
  tunerconfig with properties:

    TunableParameters: [1x14 string]
        StepForward: 1.1000
        StepBackward: 0.5000
        MaxIterations: 20
    OptimalityTolerance: 0.1000
        Display: iter
        Cost: RMS
```

Display the default tunable parameters.

```
config.TunableParameters
```

```
ans = 1x14 string
    "AccelerometerNoise"    "GyroscopeNoise"    "MagnetometerNoise"    "GPSPositionNoise"    "GPSVelocityNoise"
```

Tune insfilterAsync to Optimize Pose Estimate

Load the recorded sensor data and ground truth data.

```
load('insfilterAsyncTuneData.mat');
```

Create timetables for the sensor data and the truth data.

```
sensorData = timetable(Accelerometer, Gyroscope, ...
    Magnetometer, GPSPosition, GPSVelocity, 'SampleRate', 100);
groundTruth = timetable(Orientation, Position, ...
    'SampleRate', 100);
```

Create an insfilterAsync filter object that has a few noise properties.

```
filter = insfilterAsync('State', initialState, ...
    'StateCovariance', initialStateCovariance, ...
    'AccelerometerBiasNoise', 1e-7, ...
    'GyroscopeBiasNoise', 1e-7, ...
    'MagnetometerBiasNoise', 1e-7, ...
    'GeomagneticVectorNoise', 1e-7);
```

Create a tuner configuration object for the filter. Set the maximum iterations to two. Also, set the tunable parameters as the unspecified properties.

```
config = tunerconfig('insfilterAsync', 'MaxIterations', 8);
config.TunableParameters = setdiff(config.TunableParameters, ...
```

```

    {'GeomagneticVectorNoise', 'AccelerometerBiasNoise', ...
     'GyroscopeBiasNoise', 'MagnetometerBiasNoise'}));
config.TunableParameters
ans = 1x10 string
    "AccelerationNoise"    "AccelerometerNoise"    "AngularVelocityNoise"    "GPSPositionNoise"

```

Use the tuner noise function to obtain a set of initial sensor noises used in the filter.

```
measNoise = tunernoise('insfilterAsync')
```

```
measNoise = struct with fields:
    AccelerometerNoise: 1
    GyroscopeNoise: 1
    MagnetometerNoise: 1
    GPSPositionNoise: 1
    GPSVelocityNoise: 1

```

Tune the filter and obtain the tuned parameters.

```
tunedParams = tune(filter,measNoise,sensorData,groundTruth,config);
```

Iteration	Parameter	Metric
1	AccelerationNoise	2.1345
1	AccelerometerNoise	2.1264
1	AngularVelocityNoise	1.9659
1	GPSPositionNoise	1.9341
1	GPSVelocityNoise	1.8420
1	GyroscopeNoise	1.7589
1	MagnetometerNoise	1.7362
1	PositionNoise	1.7362
1	QuaternionNoise	1.7218
1	VelocityNoise	1.7218
2	AccelerationNoise	1.7190
2	AccelerometerNoise	1.7170
2	AngularVelocityNoise	1.6045
2	GPSPositionNoise	1.5948
2	GPSVelocityNoise	1.5323
2	GyroscopeNoise	1.4803
2	MagnetometerNoise	1.4703
2	PositionNoise	1.4703
2	QuaternionNoise	1.4632
2	VelocityNoise	1.4632
3	AccelerationNoise	1.4596
3	AccelerometerNoise	1.4548
3	AngularVelocityNoise	1.3923
3	GPSPositionNoise	1.3810
3	GPSVelocityNoise	1.3322
3	GyroscopeNoise	1.2998
3	MagnetometerNoise	1.2976
3	PositionNoise	1.2976
3	QuaternionNoise	1.2943
3	VelocityNoise	1.2943
4	AccelerationNoise	1.2906
4	AccelerometerNoise	1.2836
4	AngularVelocityNoise	1.2491

4	GPSPositionNoise	1.2258
4	GPSVelocityNoise	1.1880
4	GyroscopeNoise	1.1701
4	MagnetometerNoise	1.1698
4	PositionNoise	1.1698
4	QuaternionNoise	1.1688
4	VelocityNoise	1.1688
5	AccelerationNoise	1.1650
5	AccelerometerNoise	1.1569
5	AngularVelocityNoise	1.1454
5	GPSPositionNoise	1.1100
5	GPSVelocityNoise	1.0778
5	GyroscopeNoise	1.0709
5	MagnetometerNoise	1.0675
5	PositionNoise	1.0675
5	QuaternionNoise	1.0669
5	VelocityNoise	1.0669
6	AccelerationNoise	1.0634
6	AccelerometerNoise	1.0549
6	AngularVelocityNoise	1.0549
6	GPSPositionNoise	1.0180
6	GPSVelocityNoise	0.9866
6	GyroscopeNoise	0.9810
6	MagnetometerNoise	0.9775
6	PositionNoise	0.9775
6	QuaternionNoise	0.9768
6	VelocityNoise	0.9768
7	AccelerationNoise	0.9735
7	AccelerometerNoise	0.9652
7	AngularVelocityNoise	0.9652
7	GPSPositionNoise	0.9283
7	GPSVelocityNoise	0.8997
7	GyroscopeNoise	0.8947
7	MagnetometerNoise	0.8920
7	PositionNoise	0.8920
7	QuaternionNoise	0.8912
7	VelocityNoise	0.8912
8	AccelerationNoise	0.8885
8	AccelerometerNoise	0.8811
8	AngularVelocityNoise	0.8807
8	GPSPositionNoise	0.8479
8	GPSVelocityNoise	0.8238
8	GyroscopeNoise	0.8165
8	MagnetometerNoise	0.8165
8	PositionNoise	0.8165
8	QuaternionNoise	0.8159
8	VelocityNoise	0.8159

Fuse the sensor data using the tuned filter.

```
dt = seconds(diff(groundTruth.Time));
N = size(sensorData,1);
qEst = quaternion.zeros(N,1);
posEst = zeros(N,3);
% Iterate the filter for prediction and correction using sensor data.
for ii=1:N
    if ii ~= 1
        predict(filter, dt(ii-1));
```

```

end
if all(~isnan(Accelerometer(ii,:)))
    fuseaccel(filter, Accelerometer(ii,:), ...
              tunedParams.AccelerometerNoise);
end
if all(~isnan(Gyroscope(ii,:)))
    fusegyro(filter, Gyroscope(ii,:), ...
             tunedParams.GyroscopeNoise);
end
if all(~isnan(Magnetometer(ii,1)))
    fusemag(filter, Magnetometer(ii,:), ...
            tunedParams.MagnetometerNoise);
end
if all(~isnan(GPSPosition(ii,1)))
    fusegps(filter, GPSPosition(ii,:), ...
            tunedParams.GPSPositionNoise, GPSVelocity(ii,:), ...
            tunedParams.GPSVelocityNoise);
end
[posEst(ii,:), qEst(ii,:)] = pose(filter);
end

```

Compute the RMS errors.

```

orientationError = rad2deg(dist(qEst, Orientation));
rmsorientationError = sqrt(mean(orientationError.^2))

rmsorientationError = 2.7801

positionError = sqrt(sum((posEst - Position).^2, 2));
rmspositionError = sqrt(mean( positionError.^2))

rmspositionError = 0.5966

```

Visualize the results.

```

figure();
t = (0:N-1)./ groundTruth.Properties.SampleRate;
subplot(2,1,1)
plot(t, positionError, 'b');
title("Tuned insfilterAsync" + newline + "Euclidean Distance Position Error")
xlabel('Time (s)');
ylabel('Position Error (meters)')
subplot(2,1,2)
plot(t, orientationError, 'b');
title("Orientation Error")
xlabel('Time (s)');
ylabel('Orientation Error (degrees)');

```

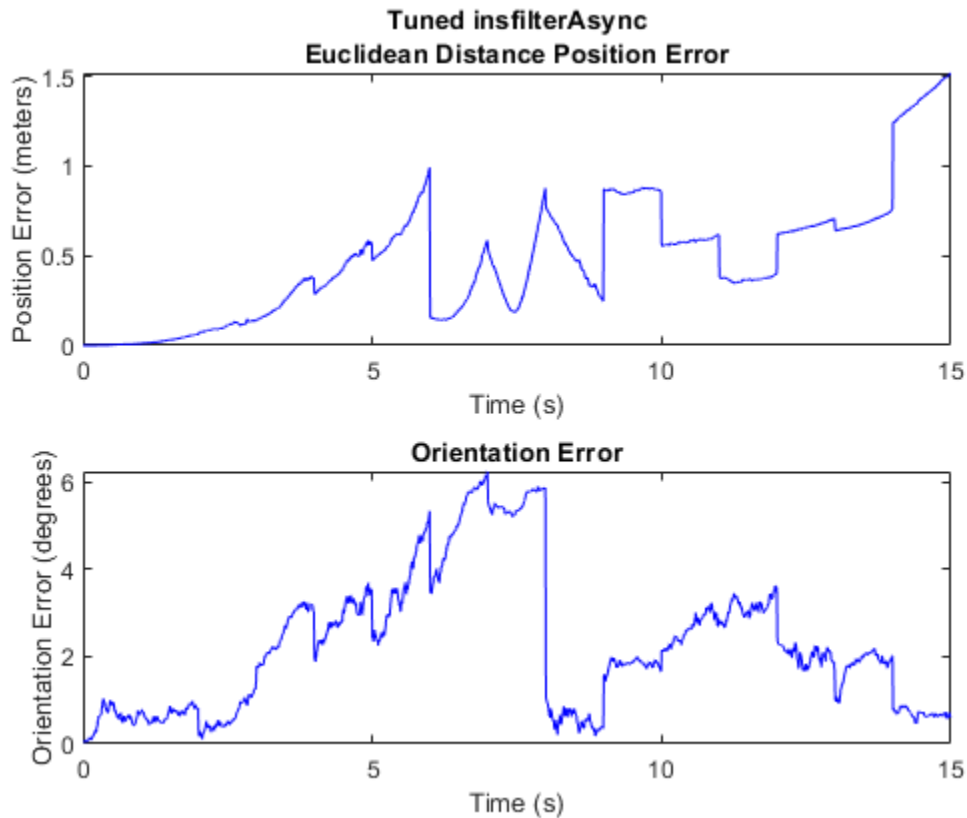
Tune imfilter to Optimize Orientation Estimate

Load recorded sensor data and ground truth data.

```
ld = load('imufilterTuneData.mat');
qTrue = ld.groundTruth.Orientation; % true orientation
```

Create an imfilter object and fuse the filter with the sensor data.

```
fuse = imufilter;
qEstUntuned = fuse(ld.sensorData.Accelerometer, ...
    ld.sensorData.Gyroscope);
```

Create a tunerconfig object and tune the imfilter to improve the orientation estimate.

```
cfg = tunerconfig('imufilter');
tune(fuse, ld.sensorData, ld.groundTruth, cfg);
```

Iteration	Parameter	Metric
1	AccelerometerNoise	0.1149
1	GyroscopeNoise	0.1146
1	GyroscopeDriftNoise	0.1146
1	LinearAccelerationNoise	0.1122
1	LinearAccelerationDecayFactor	0.1103

2	AccelerometerNoise	0.1102
2	GyroscopeNoise	0.1098
2	GyroscopeDriftNoise	0.1098
2	LinearAccelerationNoise	0.1070
2	LinearAccelerationDecayFactor	0.1053
3	AccelerometerNoise	0.1053
3	GyroscopeNoise	0.1048
3	GyroscopeDriftNoise	0.1048
3	LinearAccelerationNoise	0.1016
3	LinearAccelerationDecayFactor	0.1002
4	AccelerometerNoise	0.1001
4	GyroscopeNoise	0.0996
4	GyroscopeDriftNoise	0.0996
4	LinearAccelerationNoise	0.0962
4	LinearAccelerationDecayFactor	0.0950
5	AccelerometerNoise	0.0950
5	GyroscopeNoise	0.0943
5	GyroscopeDriftNoise	0.0943
5	LinearAccelerationNoise	0.0910
5	LinearAccelerationDecayFactor	0.0901
6	AccelerometerNoise	0.0900
6	GyroscopeNoise	0.0893
6	GyroscopeDriftNoise	0.0893
6	LinearAccelerationNoise	0.0862
6	LinearAccelerationDecayFactor	0.0855
7	AccelerometerNoise	0.0855
7	GyroscopeNoise	0.0848
7	GyroscopeDriftNoise	0.0848
7	LinearAccelerationNoise	0.0822
7	LinearAccelerationDecayFactor	0.0818
8	AccelerometerNoise	0.0817
8	GyroscopeNoise	0.0811
8	GyroscopeDriftNoise	0.0811
8	LinearAccelerationNoise	0.0791
8	LinearAccelerationDecayFactor	0.0789
9	AccelerometerNoise	0.0788
9	GyroscopeNoise	0.0782
9	GyroscopeDriftNoise	0.0782
9	LinearAccelerationNoise	0.0769
9	LinearAccelerationDecayFactor	0.0768
10	AccelerometerNoise	0.0768
10	GyroscopeNoise	0.0762
10	GyroscopeDriftNoise	0.0762
10	LinearAccelerationNoise	0.0754
10	LinearAccelerationDecayFactor	0.0753
11	AccelerometerNoise	0.0753
11	GyroscopeNoise	0.0747
11	GyroscopeDriftNoise	0.0747
11	LinearAccelerationNoise	0.0741
11	LinearAccelerationDecayFactor	0.0740
12	AccelerometerNoise	0.0740
12	GyroscopeNoise	0.0734
12	GyroscopeDriftNoise	0.0734
12	LinearAccelerationNoise	0.0728
12	LinearAccelerationDecayFactor	0.0728
13	AccelerometerNoise	0.0728
13	GyroscopeNoise	0.0721
13	GyroscopeDriftNoise	0.0721

13	LinearAccelerationNoise	0.0715
13	LinearAccelerationDecayFactor	0.0715
14	AccelerometerNoise	0.0715
14	GyroscopeNoise	0.0706
14	GyroscopeDriftNoise	0.0706
14	LinearAccelerationNoise	0.0700
14	LinearAccelerationDecayFactor	0.0700
15	AccelerometerNoise	0.0700
15	GyroscopeNoise	0.0690
15	GyroscopeDriftNoise	0.0690
15	LinearAccelerationNoise	0.0684
15	LinearAccelerationDecayFactor	0.0684
16	AccelerometerNoise	0.0684
16	GyroscopeNoise	0.0672
16	GyroscopeDriftNoise	0.0672
16	LinearAccelerationNoise	0.0668
16	LinearAccelerationDecayFactor	0.0667
17	AccelerometerNoise	0.0667
17	GyroscopeNoise	0.0655
17	GyroscopeDriftNoise	0.0655
17	LinearAccelerationNoise	0.0654
17	LinearAccelerationDecayFactor	0.0654
18	AccelerometerNoise	0.0654
18	GyroscopeNoise	0.0641
18	GyroscopeDriftNoise	0.0641
18	LinearAccelerationNoise	0.0640
18	LinearAccelerationDecayFactor	0.0639
19	AccelerometerNoise	0.0639
19	GyroscopeNoise	0.0627
19	GyroscopeDriftNoise	0.0627
19	LinearAccelerationNoise	0.0627
19	LinearAccelerationDecayFactor	0.0624
20	AccelerometerNoise	0.0624
20	GyroscopeNoise	0.0614
20	GyroscopeDriftNoise	0.0614
20	LinearAccelerationNoise	0.0613
20	LinearAccelerationDecayFactor	0.0613

Fuse the sensor data again using the tuned filter.

```
qEstTuned = fuse(ld.sensorData.Accelerometer, ...
    ld.sensorData.Gyroscope);
```

Compare the tuned and untuned filter RMS error performances.

```
dUntuned = rad2deg(dist(qEstUntuned, qTrue));
dTuned = rad2deg(dist(qEstTuned, qTrue));
rmsUntuned = sqrt(mean(dUntuned.^2))
```

```
rmsUntuned = 6.5864
```

```
rmsTuned = sqrt(mean(dTuned.^2))
```

```
rmsTuned = 3.5098
```

Visualize the results.

```
N = numel(dUntuned);
t = (0:N-1)./ fuse.SampleRate;
```

```

plot(t, dUntuned, 'r', t, dTuned, 'b');
legend('Untuned', 'Tuned');
title('imufilter - Tuned vs Untuned Error')
xlabel('Time (s)');
ylabel('Orientation Error (degrees)');

```

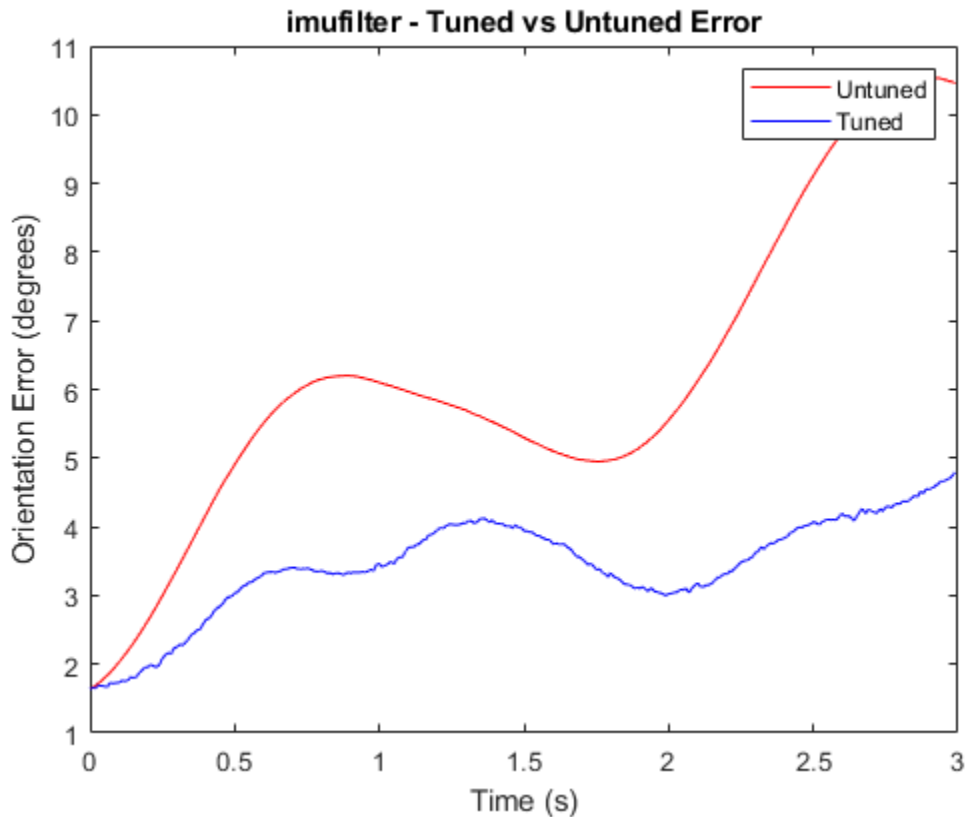

Save Tuned Parameters in MAT File Using Output Function

Load the recorded sensor data and ground truth data.

```
load('insfilterAsyncTuneData.mat');
```

Create timetables for the sensor data and the truth data.

```

sensorData = timetable(Accelerometer, Gyroscope, ...
    Magnetometer, GPSPosition, GPSVelocity, 'SampleRate', 100);
groundTruth = timetable(Orientation, Position, ...
    'SampleRate', 100);

```

Create an `insfilterAsync` filter object that has a few noise properties.

```

filter = insfilterAsync('State', initialState, ...
    'StateCovariance', initialStateCovariance, ...
    'AccelerometerBiasNoise', 1e-7, ...
    'GyroscopeBiasNoise', 1e-7, ...

```

```
'MagnetometerBiasNoise', 1e-7, ...
'GeomagneticVectorNoise', 1e-7);
```

Create a tuner configuration object for the filter. Define the `OutputFcn` property as a customized function, `myOutputFcn`, which saves the latest tuned parameters in a MAT file.

```
config = tunerconfig('insfilterAsync', ...
    'MaxIterations',5, ...
    'Display','none', ...
    'OutputFcn', @myOutputFcn);
config.TunableParameters = setdiff(config.TunableParameters, ...
    {'GeomagneticVectorNoise', 'AccelerometerBiasNoise', ...
    'GyroscopeBiasNoise', 'MagnetometerBiasNoise'});
config.TunableParameters

ans = 1x10 string
Columns 1 through 3

    "AccelerationNoise"    "AccelerometerNoise"    "AngularVelocityN..."

Columns 4 through 6

    "GPSPositionNoise"    "GPSVelocityNoise"    "GyroscopeNoise"

Columns 7 through 9

    "MagnetometerNoise"    "PositionNoise"    "QuaternionNoise"

Column 10

    "VelocityNoise"
```

Use the tuner noise function to obtain a set of initial sensor noises used in the filter.

```
measNoise = tunernoise('insfilterAsync')
```

```
measNoise = struct with fields:
    AccelerometerNoise: 1
    GyroscopeNoise: 1
    MagnetometerNoise: 1
    GPSPositionNoise: 1
    GPSVelocityNoise: 1
```

Tune the filter and obtain the tuned parameters.

```
tunedParams = tune(filter,measNoise,sensorData,groundTruth,config);
```

Display the save parameters using the saved file.

```
fileObject = matfile('myfile.mat');
fileObject.params
```

```
ans = struct with fields:
    AccelerationNoise: [88.8995 88.8995 88.8995]
    AccelerometerBiasNoise: [1.0000e-07 1.0000e-07 1.0000e-07]
    AccelerometerNoise: 0.7942
    AngularVelocityNoise: [0.0089 0.0089 0.0089]
```

```
GPSPositionNoise: 1.1664
GPSVelocityNoise: 0.5210
GeomagneticVectorNoise: [1.0000e-07 1.0000e-07 1.0000e-07]
GyroscopeBiasNoise: [1.0000e-07 1.0000e-07 1.0000e-07]
GyroscopeNoise: 0.5210
MagnetometerBiasNoise: [1.0000e-07 1.0000e-07 1.0000e-07]
MagnetometerNoise: 1.0128
PositionNoise: [5.2100e-07 5.2100e-07 5.2100e-07]
QuaternionNoise: [1.3239e-06 1.3239e-06 1.3239e-06 1.3239e-06]
ReferenceLocation: [0 0 0]
State: [28x1 double]
StateCovariance: [28x28 double]
VelocityNoise: [6.3678e-07 6.3678e-07 6.3678e-07]
```

The output function

```
function stop = myOutputFcn(params, ~)
save('myfile.mat','params'); % overwrite the file with latest
stop = false;
end
```

See Also

[ahrs10filter](#) | [ahrsfilter](#) | [imufilter](#) | [insfilterAsync](#) | [insfilterErrorState](#) | [insfilterMARG](#) | [insfilterNonholonomic](#)

Introduced in R2020b

extendedObjectMesh

Mesh representation of extended object

Description

The `extendedObjectMesh` represents the 3-D geometry of an object. The 3-D geometry is represented by faces and vertices. Use these object meshes to specify the geometry of a `Platform` for simulating lidar sensor data using `monostaticLidarSensor`.

Creation

Syntax

```
mesh = extendedObjectMesh('cuboid')
mesh = extendedObjectMesh('cylinder')
mesh = extendedObjectMesh('cylinder',n)
mesh = extendedObjectMesh('sphere')
mesh = extendedObjectMesh('sphere',n)
mesh = extendedObjectMesh(vertices,faces)
```

Description

`mesh = extendedObjectMesh('cuboid')` returns an `extendedObjectMesh` object, that defines a cuboid with unit dimensions. The origin of the cuboid is located at its geometric center.

`mesh = extendedObjectMesh('cylinder')` returns a hollow cylinder mesh with unit dimensions. The cylinder mesh has 20 equally spaced vertices around its circumference. The origin of the cylinder is located at its geometric center. The height is aligned with the z-axis.

`mesh = extendedObjectMesh('cylinder',n)` returns a cylinder mesh with n equally spaced vertices around its circumference.

`mesh = extendedObjectMesh('sphere')` returns a sphere mesh with unit dimensions. The sphere mesh has 119 vertices and 180 faces. The origin of the sphere is located at its center.

`mesh = extendedObjectMesh('sphere',n)` additionally allows you to specify the resolution, n , of the spherical mesh. The sphere mesh has $(n + 1)^2 - 2$ vertices and $2n(n - 1)$ faces.

`mesh = extendedObjectMesh(vertices,faces)` returns a mesh from faces and vertices. `vertices` and `faces` set the `Vertices` and `Faces` properties respectively.

Properties

Vertices — Vertices of defined object

N -by-3 matrix of real scalar

Vertices of the defined object, specified as an N -by-3 matrix of real scalars. N is the number of vertices. The first, second, and third element of each row represents the x-, y-, and z-position of each vertex, respectively.

Faces — Faces of defined object

M-by-3 matrix of positive integer

Faces of the defined object, specified as a M -by-3 array of positive integers. M is the number of faces. The three elements in each row are the vertex IDs of the three vertices forming the triangle face. The ID of the vertex is its corresponding row number specified in the `Vertices` property.

Object Functions

Use the object functions to develop new meshes.

<code>translate</code>	Translate mesh along coordinate axes
<code>rotate</code>	Rotate mesh about coordinate axes
<code>scale</code>	Scale mesh in each dimension
<code>applyTransform</code>	Apply forward transformation to mesh vertices
<code>join</code>	Join two object meshes
<code>scaleToFit</code>	Auto-scale object mesh to match specified cuboid dimensions
<code>show</code>	Display the mesh as a patch on the current axes

Examples

Create and Translate Cuboid Mesh

This example shows how to create an `extendedObjectMesh` object and translate the object.

Construct a cuboid mesh.

```
mesh = extendedObjectMesh('cuboid');
```

Translate the mesh by 5 units along the negative y axis.

```
mesh = translate(mesh,[0 -5 0]);
```

Visualize the mesh.

```
ax = show(mesh);  
ax.YLim = [-6 0];
```

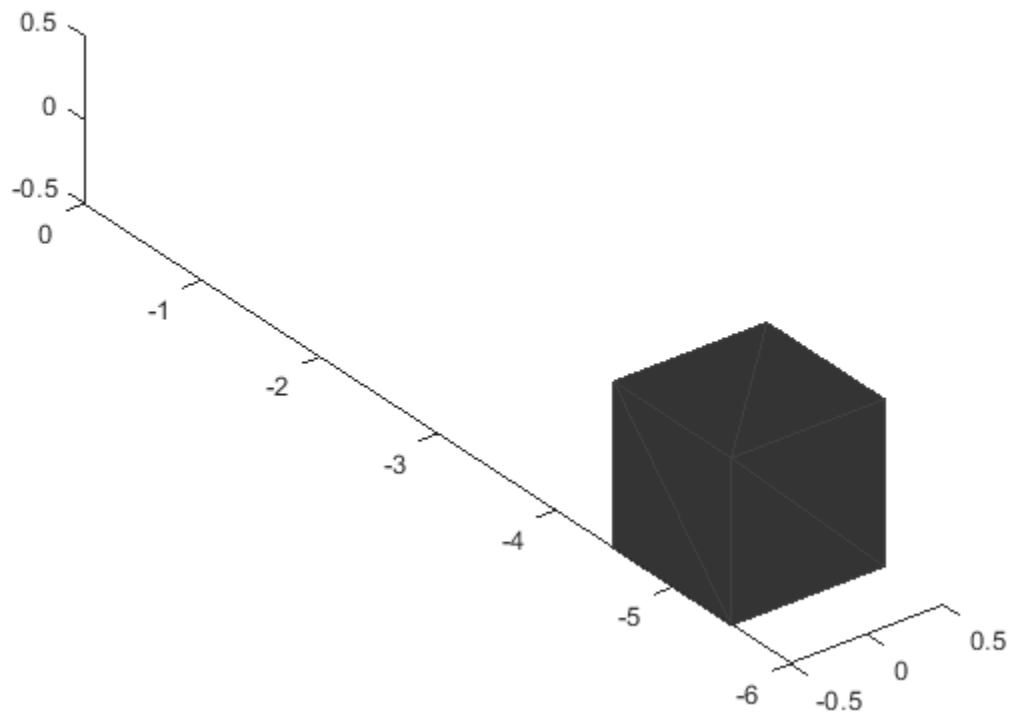
Create and Visualize Cylinder Mesh

This example shows how to create an `extendedObjectMesh` object and visualize the object.

Construct a cylinder mesh.

```
mesh = extendedObjectMesh('cylinder');
```

Visualize the mesh.

```
ax = show(mesh);
```

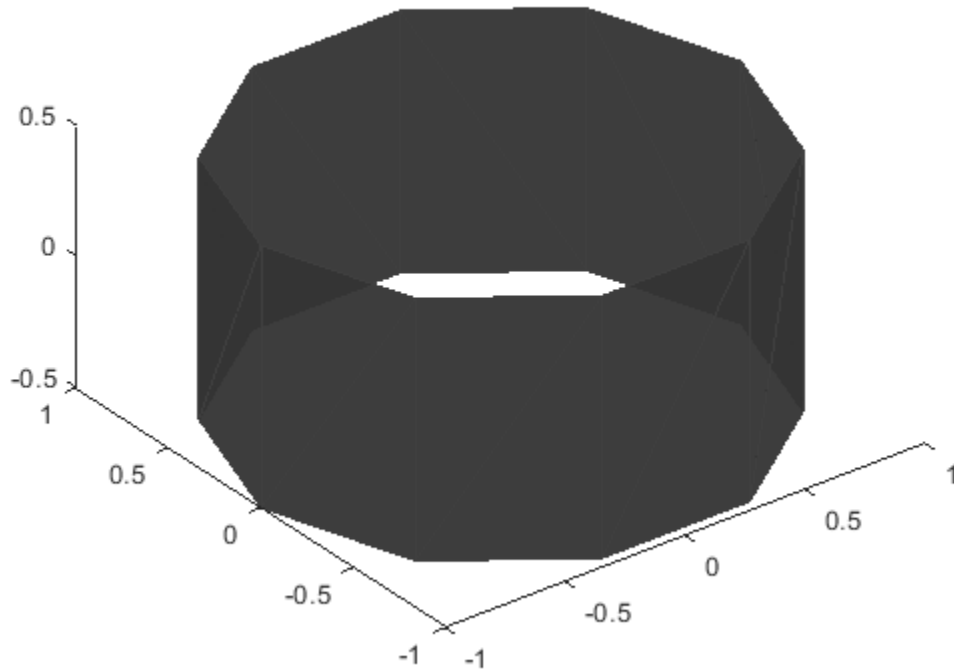

Create and Auto-scale Sphere Mesh

This example shows how to create an `extendedObjectMesh` object and auto-scale the object to the required dimensions.

Construct a sphere mesh of unit dimensions.

```
sph = extendedObjectMesh('sphere');
```

Auto-scale the mesh to the dimensions in `dims`.

```
dims = struct('Length',5,'Width',10,'Height',3,'OriginOffset',[0 0 -3]);  
sph = scaleToFit(sph,dims);
```

Visualize the mesh.

```
show(sph);
```

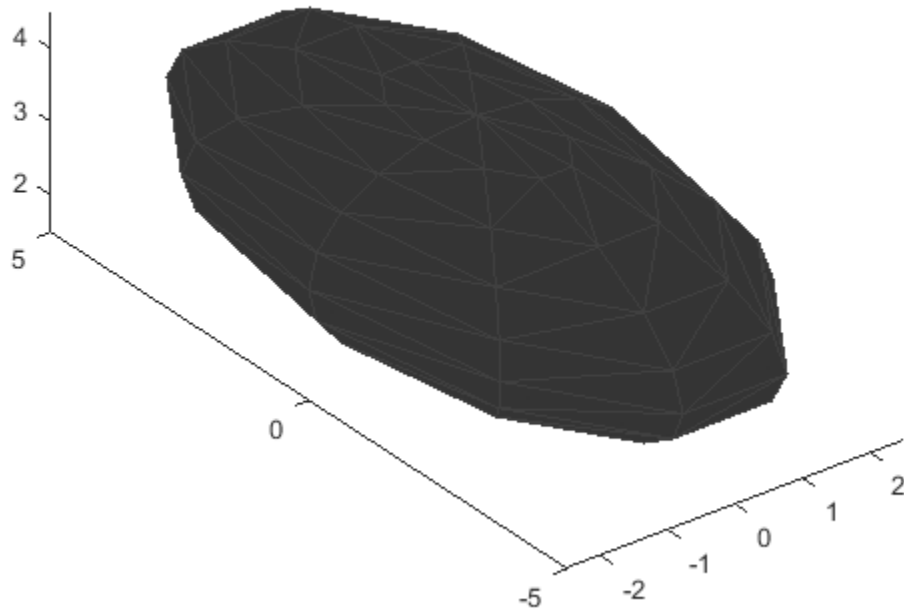

See Also

Introduced in R2020b

applyTransform

Apply forward transformation to mesh vertices

Syntax

```
transformedMesh = applyTransform(mesh,T)
```

Description

`transformedMesh = applyTransform(mesh,T)` applies the forward transformation matrix `T` to the vertices of the object mesh.

Examples

Create and Transform Cuboid Mesh

This example shows how to create an `extendedObjectMesh` object and transform the object in a way defined by a given transformation matrix.

Create a cuboid mesh of unit dimensions.

```
cuboid = extendedObjectMesh('cuboid');
```

Create a transformation matrix that is a combination of a translation, a scaling, and a rotation.

```
T = makehgtform('translate',[0.2 -0.5 0.5], 'scale',[0.5 0.6 0.7], 'xrotate',pi/4);
```

Transform the mesh.

```
transformedCuboid = applyTransform(cuboid,T);
```

Visualize the mesh.

```
subplot(1,2,1);  
show(cuboid);  
title('Initial Mesh');  
subplot(1,2,2);  
show(transformedCuboid);  
title('Transformed Mesh');
```

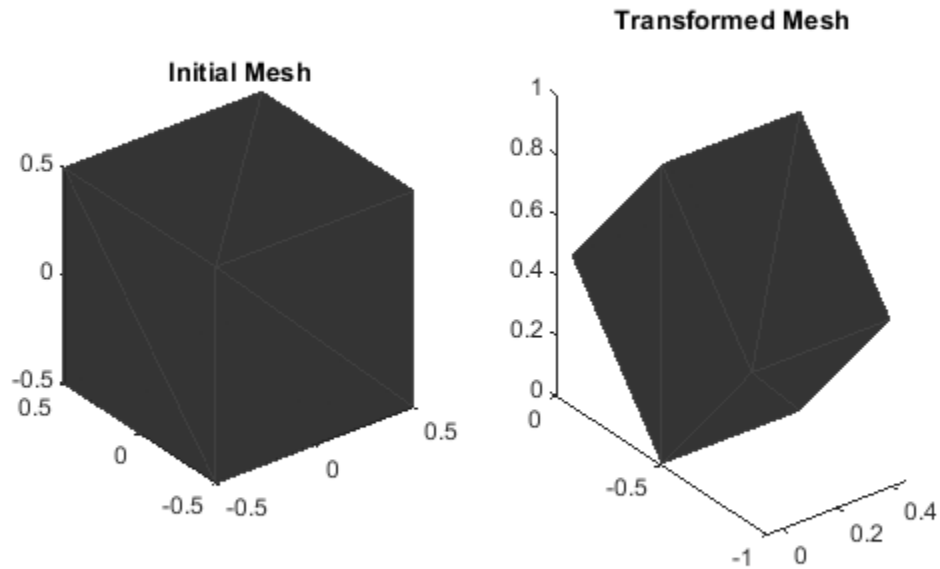

Input Arguments

mesh — Extended object mesh

`extendedObjectMesh` object

Extended object mesh, specified as an `extendedObjectMesh` object.

T — Transformation matrix

4-by-4 matrix

Transformation matrix applied on the object mesh, specified as a 4-by-4 matrix. The 3-D coordinates of each point in the object mesh is transformed according to this formula:

$$\begin{bmatrix} x_T \\ y_T \\ z_T \\ 1 \end{bmatrix} = T \cdot \begin{bmatrix} x \\ y \\ z \\ 1 \end{bmatrix}$$

x_T , y_T , and z_T are the transformed 3-D coordinates of the point.

Data Types: `single` | `double`

Output Arguments

transformedMesh — Transformed object mesh

`extendedObjectMesh` object

Transformed object mesh, returned as an `extendedObjectMesh` object.

See Also

Objects

extendedObjectMesh

Functions

join | rotate | scale | scaleToFit | show | translate

Introduced in R2020b

join

Join two object meshes

Syntax

```
joinedMesh = join(mesh1,mesh2)
```

Description

`joinedMesh = join(mesh1,mesh2)` joins the object meshes `mesh1` and `mesh2` and returns `joinedMesh` with the combined objects.

Examples

Create and Join Two Object Meshes

This example shows how to create `extendedObjectMesh` objects and join them together.

Construct two meshes of unit dimensions.

```
sph = extendedObjectMesh('sphere');  
cub = extendedObjectMesh('cuboid');
```

Join the two meshes.

```
cub = translate(cub,[0 0 1]);  
sphCub = join(sph,cub);
```

Visualize the final mesh.

```
show(sphCub);
```

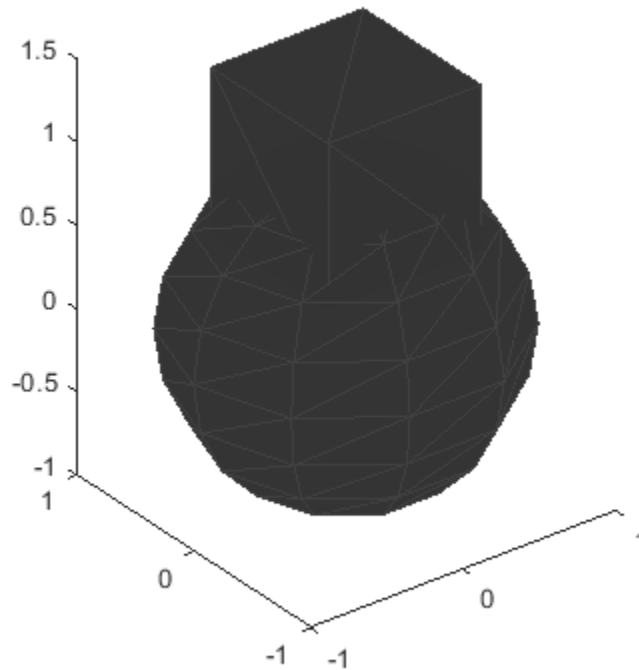

Input Arguments

mesh1 — Extended object mesh
`extendedObjectMesh` object

Extended object mesh, specified as an `extendedObjectMesh` object.

mesh2 — Extended object mesh
`extendedObjectMesh` object

Extended object mesh, specified as an `extendedObjectMesh` object.

Output Arguments

joinedMesh — Joined object mesh
`extendedObjectMesh` object

Joined object mesh, specified as an `extendedObjectMesh` object.

See Also

Objects
`extendedObjectMesh`

Functions

applyTransform | rotate | scale | scaleToFit | show | translate

Introduced in R2020b

rotate

Rotate mesh about coordinate axes

Syntax

```
rotatedMesh = rotate(mesh,orient)
```

Description

`rotatedMesh = rotate(mesh,orient)` rotate the mesh object by an orientation, `orient`.

Examples

Create and Rotate Cuboid Mesh

This example shows how to create an `extendedObjectMesh` object and rotate the object.

Construct a cuboid mesh.

```
mesh = extendedObjectMesh('cuboid');
```

Rotate the mesh by 30 degrees around the *z* axis.

```
mesh = rotate(mesh,[30 0 0]);
```

Visualize the mesh.

```
ax = show(mesh);
```

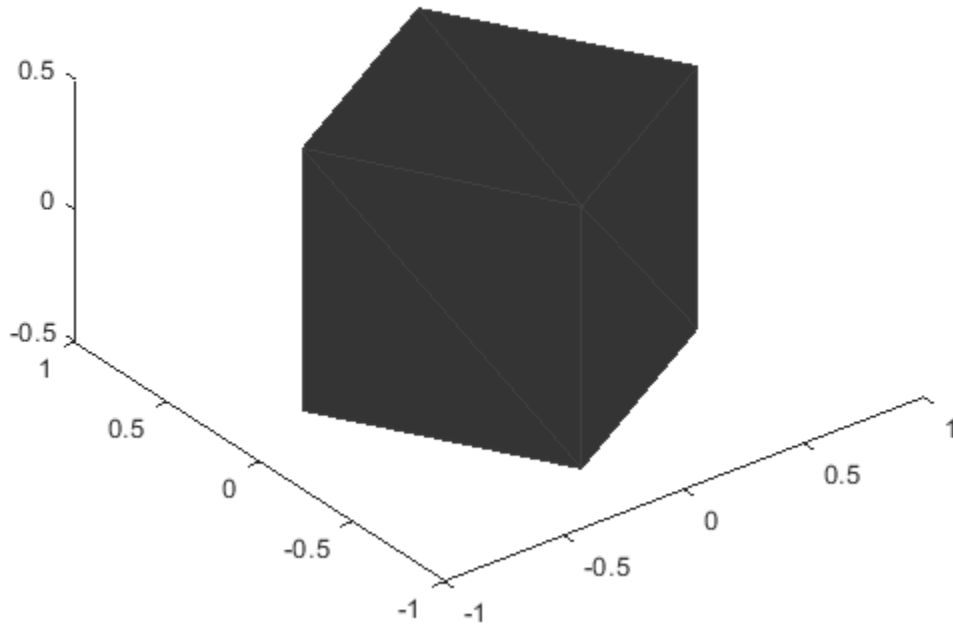

Input Arguments

mesh — Extended object mesh
extendedObjectMesh object

Extended object mesh, specified as an extendedObjectMesh object.

orient — Description of rotation
3-by-3 orthonormal matrix | quaternion | 1-by-3 vector

Description of rotation for an object mesh, specified as:

- 3-by-3 orthonormal rotation matrix
- quaternion
- 1-by-3 vector, where the elements are positive rotations in degrees about the z , y , and x axes, in that order.

Output Arguments

rotatedMesh — Rotated object mesh
extendedObjectMesh object

Rotated object mesh, returned as an extendedObjectMesh object.

See Also

Objects

extendedObjectMesh

Functions

applyTransform | join | scale | scaleToFit | show | translate

Introduced in R2020a

scale

Scale mesh in each dimension

Syntax

```
scaledMesh = scale(mesh,scaleFactor)
scaledMesh = scale(mesh,[sx sy sz])
```

Description

`scaledMesh = scale(mesh,scaleFactor)` scales the object mesh by `scaleFactor`. `scaleFactor` can be the same for all dimensions or defined separately as elements of a 1-by-3 vector in the order *x*, *y*, and *z*.

`scaledMesh = scale(mesh,[sx sy sz])` scales the object mesh along the dimensions *x*, *y*, and *z* by the scaling factors *sx*, *sy*, and *sz*.

Examples

Create and Scale Cuboid Mesh

This example shows how to create an `extendedObjectMesh` object and scale the object.

Construct a cuboid mesh of unit dimensions.

```
cuboid = extendedObjectMesh('cuboid');
```

Scale the mesh by different factors along each of the three axes.

```
scaledCuboid = scale(cuboid,[100 30 20]);
```

Visualize the mesh.

```
show(scaledCuboid);
```

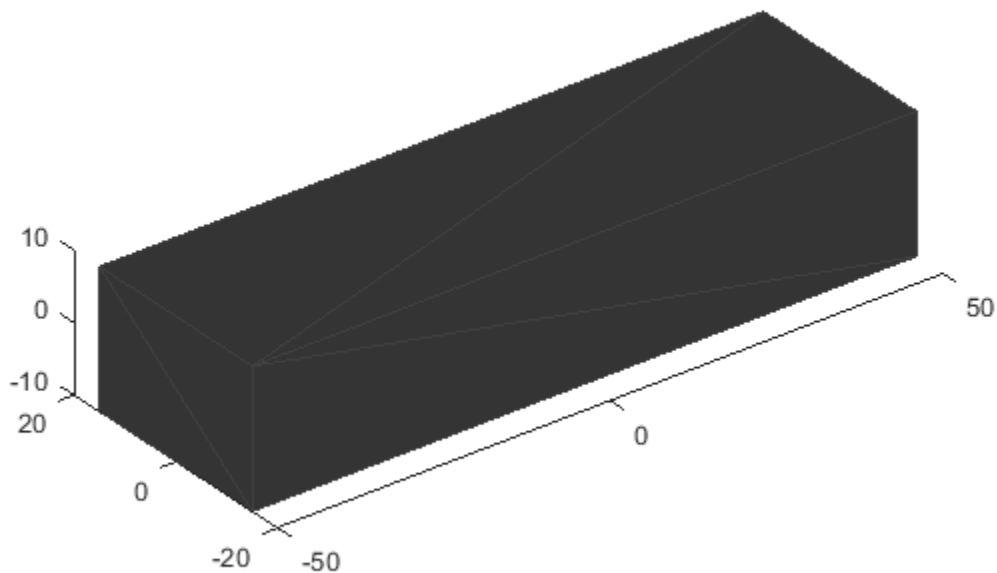

Input Arguments

mesh — Extended object mesh

`extendedObjectMesh` object

Extended object mesh, specified as an `extendedObjectMesh` object.

scaleFactor — Scaling factor

positive real scalar | 1-by-3 vector

Scaling factor for the object mesh, specified as a single positive real value or as a 1-by-3 vector in the order x , y , and z .

Data Types: `single` | `double`

sx — Scaling factor for x-axis

positive real scalar

Scaling factor for x -axis, specified as a positive real scalar.

Data Types: `single` | `double`

sy — Scaling factor for y-axis

positive real scalar

Scaling factor for y -axis, specified as a positive real scalar.

Data Types: `single` | `double`

sz — Scaling factor for z-axis

positive real scalar

Scaling factor for z-axis, specified as a positive real scalar.

Data Types: `single` | `double`

Output Arguments

scaledMesh — Scaled object mesh

`extendedObjectMesh` object

Scaled object mesh, returned as an `extendedObjectMesh` object.

See Also

Objects

`extendedObjectMesh`

Functions

`applyTransform` | `join` | `rotate` | `scaleToFit` | `show` | `translate`

Introduced in R2020b

scaleToFit

Auto-scale object mesh to match specified cuboid dimensions

Syntax

```
scaledMesh = scaleToFit(mesh,dims)
```

Description

`scaledMesh = scaleToFit(mesh,dims)` auto-scales the object mesh to match the dimensions of a cuboid specified in the structure `dims`.

Examples

Create and Auto-scale Sphere Mesh

This example shows how to create an `extendedObjectMesh` object and auto-scale the object to the required dimensions.

Construct a sphere mesh of unit dimensions.

```
sph = extendedObjectMesh('sphere');
```

Auto-scale the mesh to the dimensions in `dims`.

```
dims = struct('Length',5,'Width',10,'Height',3,'OriginOffset',[0 0 -3]);  
sph = scaleToFit(sph,dims);
```

Visualize the mesh.

```
show(sph);
```

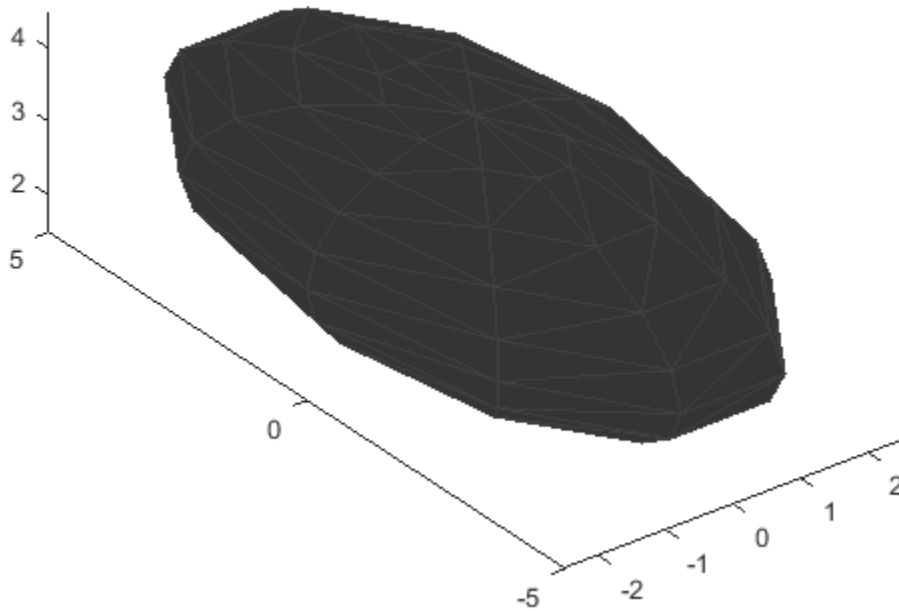
Input Arguments

mesh — Extended object mesh

`extendedObjectMesh` object

Extended object mesh, specified as an `extendedObjectMesh`

dims — Cuboid dimensions

`struct`

Dimensions of the cuboid to scale an object mesh, specified as a `struct` with these fields:

- `Length` - Length of the cuboid
- `Width` - Width of the cuboid
- `Height` - Height of the cuboid
- `OriginOffset` - Origin offset in 3-D coordinates

All the dimensions are in meters.

Data Types: `struct`

Output Arguments

scaledMesh — Scaled object mesh

`extendedObjectMesh` object

Scaled object mesh, returned as an `extendedObjectMesh` object.

See Also

Objects

`extendedObjectMesh`

Functions

`applyTransform` | `join` | `rotate` | `scale` | `show` | `translate`

Introduced in R2020b

show

Display the mesh as a patch on the current axes

Syntax

```
show(mesh)
show(mesh, ax)
ax = show(mesh)
```

Description

`show(mesh)` displays the as a patch on the current axes. If there are no active axes, the function creates new axes.

`show(mesh, ax)` displays the object `mesh` as a patch on the axes `ax`.

`ax = show(mesh)` optionally outputs the handle to the axes where the mesh was plotted.

Examples

Create and Translate Cuboid Mesh

This example shows how to create an `extendedObjectMesh` object and translate the object.

Construct a cuboid mesh.

```
mesh = extendedObjectMesh('cuboid');
```

Translate the mesh by 5 units along the negative y axis.

```
mesh = translate(mesh, [0 -5 0]);
```

Visualize the mesh.

```
ax = show(mesh);
ax.YLim = [-6 0];
```

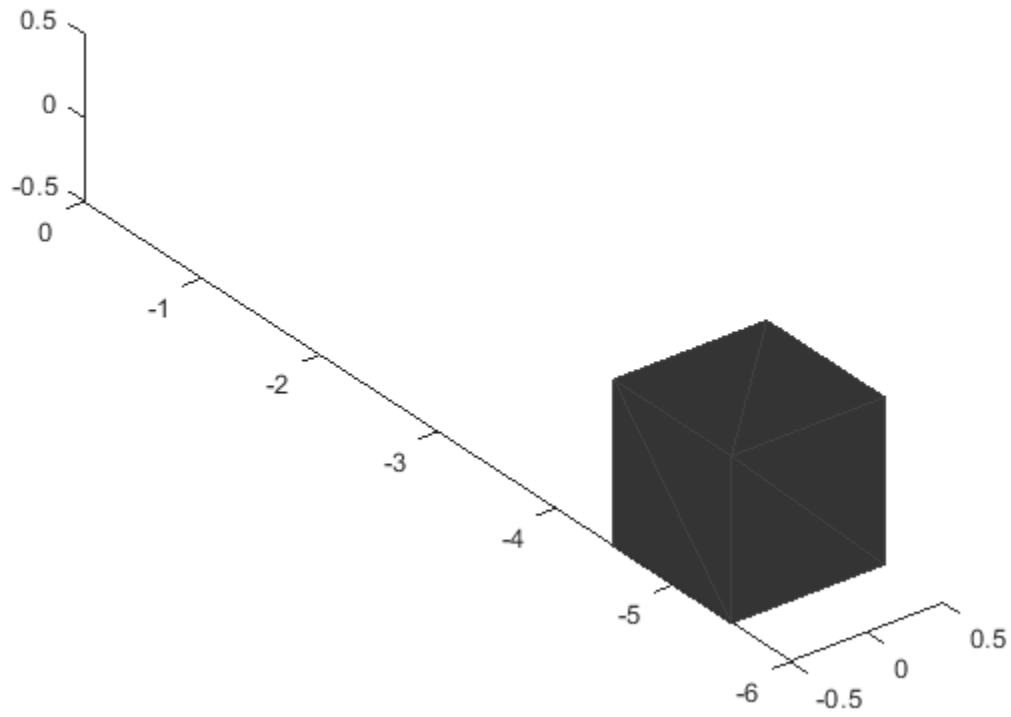

Input Arguments

mesh — Extended object mesh

`extendedObjectMesh` object

Extended object mesh, specified as an `extendedObjectMesh` object.

ax — Current axes

`axes`

Current axes, specified as an `axes` object.

See Also

Objects

`extendedObjectMesh`

Functions

`applyTransform` | `join` | `rotate` | `scale` | `scaleToFit` | `translate`

Introduced in R2020b

translate

Translate mesh along coordinate axes

Syntax

```
translatedMesh = translate(mesh,deltaPos)
```

Description

`translatedMesh = translate(mesh,deltaPos)` translates the object mesh by the distances specified by `deltaPos` along the coordinate axes.

Examples

Create and Translate Cuboid Mesh

This example shows how to create an `extendedObjectMesh` object and translate the object.

Construct a cuboid mesh.

```
mesh = extendedObjectMesh('cuboid');
```

Translate the mesh by 5 units along the negative y axis.

```
mesh = translate(mesh,[0 -5 0]);
```

Visualize the mesh.

```
ax = show(mesh);  
ax.YLim = [-6 0];
```

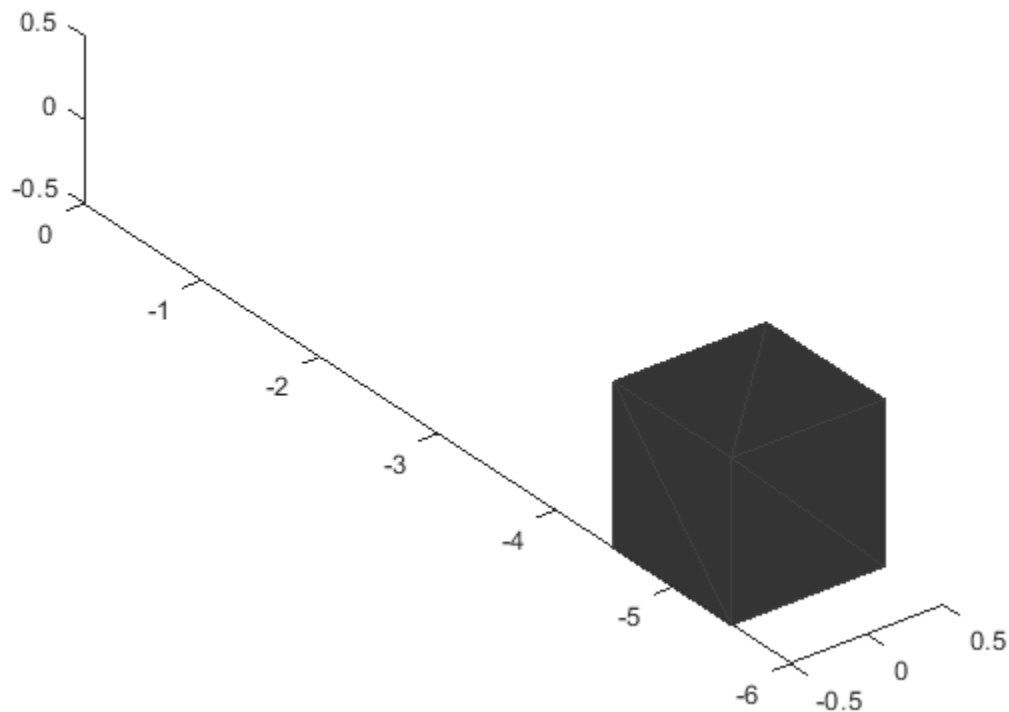

Input Arguments

mesh — Extended object mesh
`extendedObjectMesh` object

Extended object mesh, specified as an `extendedObjectMesh` object.

deltaPos — Translation vector
three-element, real-valued vector

Translation vector for an object mesh, specified as a three-element, real-valued vector. The three elements in the vector define the translation along the *x*, *y*, and *z* axes.

Data Types: `single` | `double`

Output Arguments

translatedMesh — Translated object mesh
`extendedObjectMesh` object

Translated object mesh, returned as an `extendedObjectMesh` object.

See Also

Objects

`extendedObjectMesh`

Functions

`applyTransform` | `join` | `rotate` | `scale` | `scaleToFit` | `show`

Introduced in R2020b

tracking.scenario.airplaneMesh

Mesh representation of airplane

Syntax

```
mesh = tracking.scenario.airplaneMesh
```

Description

`mesh = tracking.scenario.airplaneMesh` returns an `extendedObjectMesh` object defining an airplane mesh that can be used with the `trackingScenario` object.

Examples

Create and Visualize Airplane Mesh

Create the airplane mesh.

```
mesh = tracking.scenario.airplaneMesh;
```

Visualize the mesh.

```
ax = axes('ZDir','reverse');  
show(mesh,ax);  
view(30,50);
```

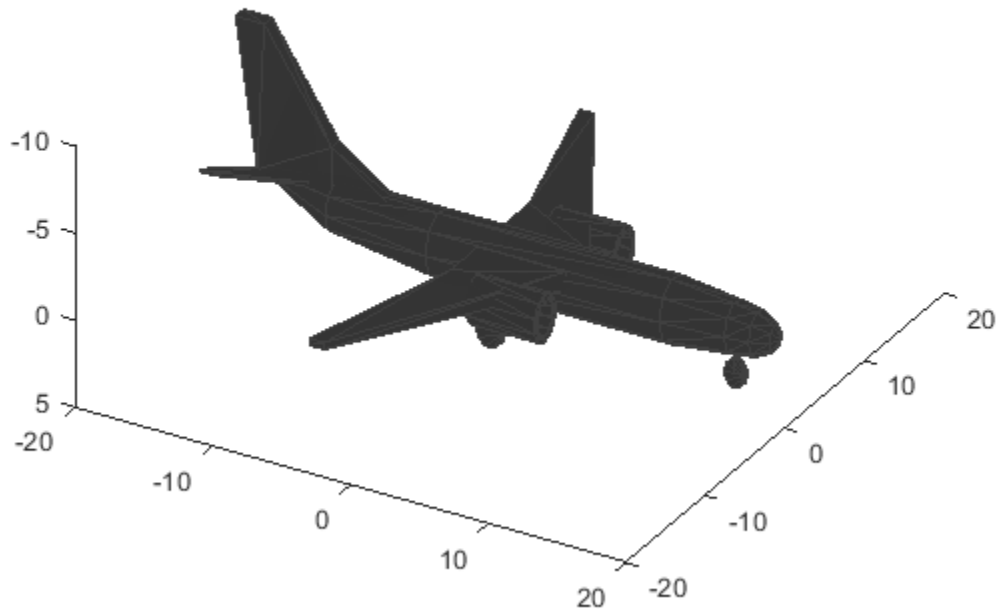
Simulate Lidar Detection with Airplane Mesh

Create a tracking scenario object and an airplane mesh object.

```
scene = trackingScenario;
mesh = tracking.scenario.airplaneMesh;
```

Create two tower platforms.

```
% Create the first tower.
tower = platform(scene);
h = 50;
tower.Trajectory.Position = [0 0 -h];
tower.Dimensions = struct('Length',10,'Width',10,'Height',h,'OriginOffset',[0 0 -h/2]);
tower.Sensors = monostaticLidarSensor('SensorIndex',1,...
    'MaxRange',200,...
    'HasINS',true,...
    'DetectionCoordinates','scenario',...
    'AzimuthLimits',[-75 75],...
    'ElevationLimits',[-10 30]);

% Create the second tower.
tower2 = platform(scene);
h = 50;
tower2.Trajectory.Position = [0 500 -h];
```

```

tower2.Dimensions = struct('Length',10,'Width',10,'Height',h,'OriginOffset',[0 0 -h/2]);
tower2.Sensors = monostaticLidarSensor('SensorIndex',2,...
    'MaxRange',200,...
    'HasINS',true,...
    'DetectionCoordinates','scenario',...
    'AzimuthLimits',[-75 75],...
    'ElevationLimits',[-10 30]);

```

Create the airplane target with associated mesh.

```

airplane = platform(scene);
airplane.Mesh = mesh;
% Set the dimensions of the plane which automatically adjust the size of the mesh.
airplane.Dimensions = struct('Length',40,...
    'Width',40,...
    'Height',12.5,...
    'OriginOffset',[0 0 12.5/2]);

```

Create a landing trajectory for the plane.

```

x = 50*ones(10,1);
y = linspace(-500,1000,10)';
yToLand = max(0,-y);
z = -1e4*(2.*(yToLand./50e3).^3 + 3*(yToLand./50e3).^2);
wps = [x y z];
toa = linspace(0,30,10)';
traj = waypointTrajectory(wps,toa);
airplane.Trajectory = traj;

```

Create a plotter to visualize the scenario.

```

lp = scatter3(nan,nan,nan,6,nan,'o','DisplayName','Lidar data');
tp = theaterPlot('Parent',lp.Parent,...
    'XLimits',[0 100],...
    'YLimits',[-500 1000],...
    'ZLimits',[-75 0]);
lp.Parent.ZDir = 'reverse';
view(lp.Parent,169,5);
pp = platformPlotter(tp,'DisplayName','Platforms','Marker','^');
cp = coveragePlotter(tp,'DisplayName','Lidar coverage');
hold on;

```

Advance the simulation, generate data, and visualize the results.

```

scene.UpdateRate = 0; % Automatic update rate
while advance(scene)
    % Generate point cloud.
    ptCloud = lidarDetect(scene);

    % Obtain coverage configurations.
    cfgs = coverageConfig(scene);

    % Plot coverage.
    cp.plotCoverage(cfgs);

    % Plot platforms.
    platPoses = platformPoses(scene);
    pos = vertcat(platPoses.Position);
    mesh = cellfun(@(x)x.Mesh,scene.Platforms);

```

```

orient = vertcat(platPoses.Orientation);
pp.plotPlatform(pos,mesh,orient);

% Concatenate all point clouds.
s = vertcat(ptCloud{:});
% Plot lidar data.
set(lp, 'XData',s(:,1),...
      'YData',s(:,2),...
      'ZData',s(:,3),...
      'CData',s(:,3));
drawnow;
end

```

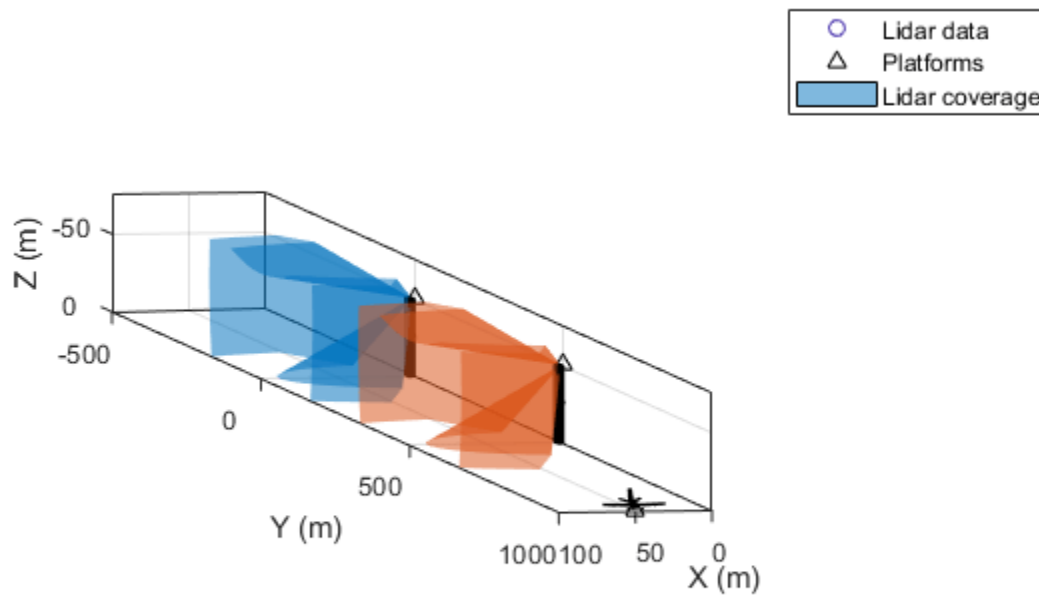

Output Arguments

mesh — Airplane mesh

extendedObjectMesh object

Airplane mesh, returned as an extendedObjectMesh object defining the mesh of an airplane.

See Also

extendedObjectMesh | lidarDetect | monostaticLidarSensor

Introduced in R2020b

trackingKF

Linear Kalman filter for object tracking

Description

A `trackingKF` object is a discrete-time linear Kalman filter used to track the positions and velocities of target platforms.

A Kalman filter is a recursive algorithm for estimating the evolving state of a process when measurements are made on the process. The filter is linear when the evolution of the state follows a linear motion model and the measurements are linear functions of the state. The filter assumes that both the process and measurements have additive noise. When the process noise and measurement noise are Gaussian, the Kalman filter is the optimal minimum mean squared error (MMSE) state estimator for linear processes.

You can use this object in these ways:

- Explicitly set the motion model. Set the motion model property, `MotionModel`, to `Custom`, and then use the `StateTransitionModel` property to set the state transition matrix.
- Set the `MotionModel` property to a predefined state transition model:

Motion Model
'1D Constant Velocity'
'1D Constant Acceleration'
'2D Constant Velocity'
'2D Constant Acceleration'
'3D Constant Velocity'
'3D Constant Acceleration'

Creation

Syntax

```
filter = trackingKF
filter = trackingKF(F,H)
filter = trackingKF(F,H,G)
filter = trackingKF('MotionModel',model)
filter = trackingKF(__,Name,Value)
```

Description

`filter = trackingKF` creates a linear Kalman filter object for a discrete-time, 2-D, constant-velocity moving object. The Kalman filter uses default values for the `StateTransitionModel`, `MeasurementModel`, and `ControlModel` properties. The function also sets the `MotionModel` property to `'2D Constant Velocity'`.

`filter = trackingKF(F,H)` specifies the state transition model, F , and the measurement model, H . With this syntax, the function also sets the `MotionModel` property to `'Custom'`.

`filter = trackingKF(F,H,G)` also specifies the control model, G . With this syntax, the function also sets the `MotionModel` property to `'Custom'`.

`filter = trackingKF('MotionModel',model)` sets the motion model property, `MotionModel`, to `model`.

`filter = trackingKF(____,Name,Value)` configures the properties of the Kalman filter by using one or more `Name,Value` pair arguments and any of the previous syntaxes. Any unspecified properties take default values.

Properties

State — Kalman filter state

0 (default) | real-valued scalar | real-valued M -element vector

Kalman filter state, specified as a real-valued M -element vector. M is the size of the state vector. Typical state vector sizes are described in the `MotionModel` property. When the initial state is specified as a scalar, the state is expanded into an M -element vector.

You can set the state to a scalar in these cases:

- When the `MotionModel` property is set to `'Custom'`, M is determined by the size of the state transition model.
- When the `MotionModel` property is set to `'2D Constant Velocity'`, `'3D Constant Velocity'`, `'2D Constant Acceleration'`, or `'3D Constant Acceleration'`, you must first specify the state as an M -element vector. You can use a scalar for all subsequent specifications of the state vector.

Example: `[200;0.2;-40;-0.01]`

Data Types: `double`

StateCovariance — State estimation error covariance

1 (default) | positive scalar | positive-definite real-valued M -by- M matrix

State error covariance, specified as a positive scalar or a positive-definite real-valued M -by- M matrix, where M is the size of the state. Specifying the value as a scalar creates a multiple of the M -by- M identity matrix. This matrix represents the uncertainty in the state.

Example: `[20 0.1; 0.1 1]`

Data Types: `double`

MotionModel — Kalman filter motion model

`'Custom'` (default) | `'1D Constant Velocity'` | `'2D Constant Velocity'` | `'3D Constant Velocity'` | `'1D Constant Acceleration'` | `'2D Constant Acceleration'` | `'3D Constant Acceleration'`

Kalman filter motion model, specified as `'Custom'` or one of these predefined models. In this case, the state vector and state transition matrix take the form specified in the table.

Motion Model	Form of State Vector	Form of State Transition Model
'1D Constant Velocity'	[x;vx]	[1 dt; 0 1]
'2D Constant Velocity'	[x;vx;y;vy]	Block diagonal matrix with the [1 dt; 0 1] block repeated for the x and y spatial dimensions
'3D Constant Velocity'	[x;vx;y;vy;z;vz]	Block diagonal matrix with the [1 dt; 0 1] block repeated for the x, y, and z spatial dimensions.
'1D Constant Acceleration'	[x;vx;ax]	[1 dt 0.5*dt^2; 0 1 dt; 0 0 1]
'2D Constant Acceleration'	[x;vx;ax;y;vy;ay]	Block diagonal matrix with [1 dt 0.5*dt^2; 0 1 dt; 0 0 1] blocks repeated for the x and y spatial dimensions
'3D Constant Acceleration'	[x;vx,ax;y;vy;ay;z;vz;az]	Block diagonal matrix with the [1 dt 0.5*dt^2; 0 1 dt; 0 0 1] block repeated for the x, y, and z spatial dimensions

When the ControlModel property is defined, every nonzero element of the state transition model is replaced by dt.

When MotionModel is 'Custom', you must specify a state transition model matrix, a measurement model matrix, and optionally, a control model matrix as input arguments to the Kalman filter.

Data Types: char

StateTransitionModel — State transition model between time steps

[1 1 0 0; 0 1 0 0; 0 0 1 1; 0 0 0 1] (default) | real-valued M -by- M matrix

State transition model between time steps, specified as a real-valued M -by- M matrix. M is the size of the state vector. In the absence of controls and noise, the state transition model relates the state at any time step to the state at the previous step. The state transition model is a function of the filter time step size.

Example: [1 0; 1 2]

Dependencies

To enable this property, set MotionModel to 'Custom'.

Data Types: double

ControlModel — Control model

[] (default) | M -by- L real-valued matrix

Control model, specified as an M -by- L matrix. M is the dimension of the state vector and L is the number of controls or forces. The control model adds the effect of controls on the evolution of the state.

Example: [.01 0.2]

Data Types: double

ProcessNoise — Covariance of process noise

1 (default) | positive scalar | real-valued positive-definite M -by- M matrix

Covariance of process noise, specified as a positive scalar or an M -by- M matrix where M is the dimension of the state. If you specify this property as a scalar, the filter uses the value as a multiplier of the M -by- M identity matrix. Process noise expresses the uncertainty in the dynamic model and is assumed to be zero-mean Gaussian white noise.

Tip If you specify the `MotionModel` property as any of the predefined motion model, then the corresponding process noise is automatically generated during construction and updated during propagation. In this case, you do not need to specify the `ProcessNoise` property. In fact, the filter neglects your process noise input during object construction. If you want to specify the process noise other than the default values, use the `trackingEKF` object.

Data Types: double

MeasurementModel — Measurement model from state vector

[1 0 0 0; 0 0 1 0] (default) | real-valued N -by- M matrix

Measurement model from the state vector, specified as a real-valued N -by- M matrix, where N is the size of the measurement vector and M is the size of the state vector. The measurement model is a linear matrix that determines predicted measurements from the predicted state.

Example: [1 0.5 0.01; 1.0 1 0]

Data Types: double

MeasurementNoise — Measurement noise covariance

1 (default) | positive scalar | positive-definite real-valued N -by- N matrix

Covariance of the measurement noise, specified as a positive scalar or a positive-definite, real-valued N -by- N matrix, where N is the size of the measurement vector. If you specify this property as a scalar, the filter uses the value as a multiplier of the N -by- N identity matrix. Measurement noise represents the uncertainty of the measurement and is assumed to be zero-mean Gaussian white noise.

Example: 0.2

Data Types: double

EnableSmoothing — Enable state smoothing

false (default) | true

Enable state smoothing, specified as `false` or `true`. Setting this property to `true` requires the Sensor Fusion and Tracking Toolbox license. When specified as `true`, you can:

- Use the `smooth` function, provided in Sensor Fusion and Tracking Toolbox, to smooth state estimates in the previous steps. Internally, the filter stores the results from previous steps to allow backward smoothing.
- Specify the maximum number of smoothing steps using the `MaxNumSmoothingSteps` property of the tracking filter.

MaxNumSmoothingSteps — Maximum number of smoothing steps

5 (default) | positive integer

Maximum number of backward smoothing steps, specified as a positive integer.

Dependencies

To enable this property, set the `EnableSmoothing` property to `true`.

Object Functions

<code>predict</code>	Predict state and state estimation error covariance of linear Kalman filter
<code>correct</code>	Correct state and state estimation error covariance using tracking filter
<code>correctjtpda</code>	Correct state and state estimation error covariance using tracking filter and JPDA
<code>distance</code>	Distances between current and predicted measurements of tracking filter
<code>likelihood</code>	Likelihood of measurement from tracking filter
<code>clone</code>	Create duplicate tracking filter
<code>residual</code>	Measurement residual and residual noise from tracking filter
<code>smooth</code>	Backward smooth state estimates of tracking filter
<code>initialize</code>	Initialize state and covariance of tracking filter

Examples

Constant-Velocity Linear Kalman Filter

Create a linear Kalman filter that uses a 2D Constant Velocity motion model. Assume that the measurement consists of the object's x-y location.

Specify the initial state estimate to have zero velocity.

```
x = 5.3;
y = 3.6;
initialState = [x;0;y;0];
KF = trackingKF('MotionModel','2D Constant Velocity','State',initialState);
```

Create the measured positions from a constant-velocity trajectory.

```
vx = 0.2;
vy = 0.1;
T = 0.5;
pos = [0:vx*T:2;5:vy*T:6]';
```

Predict and correct the state of the object.

```
for k = 1:size(pos,1)
    pstates(k,:) = predict(KF,T);
    cstates(k,:) = correct(KF,pos(k,:));
end
```

Plot the tracks.

```
plot(pos(:,1),pos(:,2),'k.', pstates(:,1),pstates(:,3),'+', ...
      cstates(:,1),cstates(:,3),'o')
xlabel('x [m]')
ylabel('y [m]')
grid
xt = [x-2 pos(1,1)+0.1 pos(end,1)+0.1];
yt = [y pos(1,2) pos(end,2)];
```



```
text(xt,yt,{'First measurement','First position','Last position'})
legend('Object position', 'Predicted position', 'Corrected position')
```

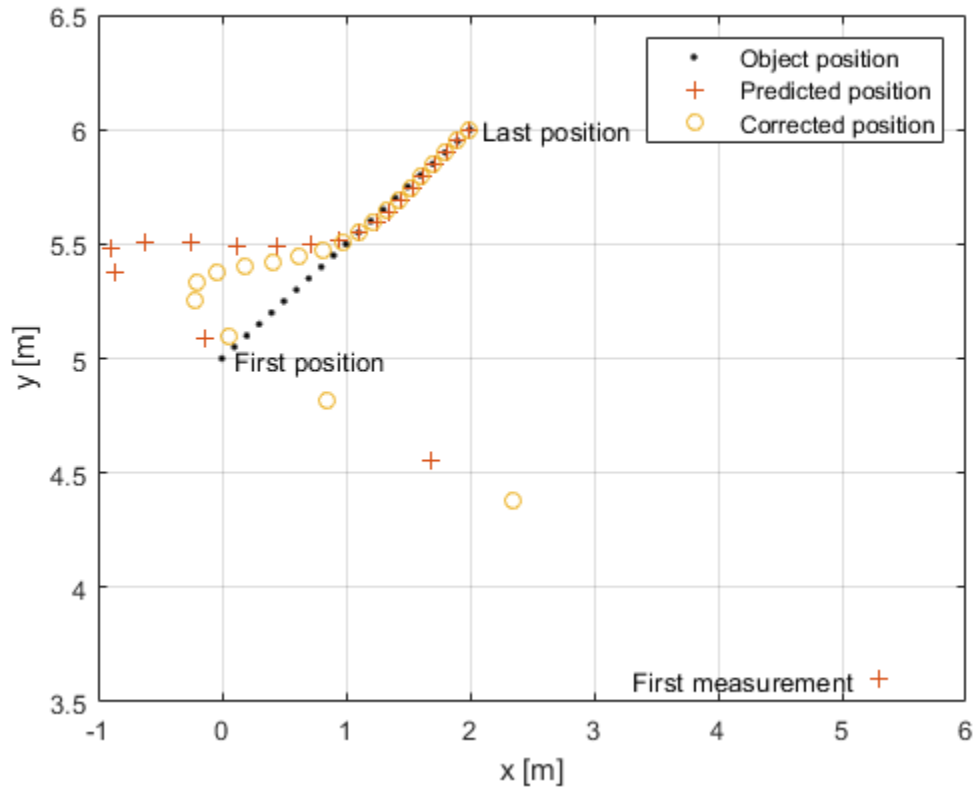

More About

Filter Parameters

This table relates the filter model parameters to the object properties. M is the size of the state vector. N is the size of the measurement vector. L is the size of the control model.

Model Parameter	Description	Filter Property	Size
F_k	State transition model that specifies a linear model of the force-free equations of motion of the object. This model, together with the control model, determines the state at time $k+1$ as a function of the state at time k . The state transition model depends on the time step of the filter.	StateTransitionModel	M -by- M
H_k	Measurement model that specifies how the measurements are linear functions of the state.	MeasurementModel	N -by- M
G_k	Control model describing the controls or forces acting on the object.	ControlModel	M -by- L
x_k	Estimate of the state of the object.	State	M -
P_k	Estimated covariance matrix of the state. The covariance represents the uncertainty in the values of the state.	StateCovariance	M -by- M
Q_k	Estimate of the process noise covariance matrix at step k . Process noise is a measure of the uncertainty in your dynamic model and is assumed to be zero-mean white Gaussian noise.	ProcessNoise	M -by- M
R_k	Estimate of the measurement noise covariance at step k . Measurement noise represents the uncertainty of the measurement and is assumed to be zero-mean white Gaussian noise.	MeasurementNoise	N -by- N

Algorithms

The Kalman filter describes the motion of an object by estimating its state. The state generally consists of object position and velocity and possibly its acceleration. The state can span one, two, or three spatial dimensions. Most frequently, you use the Kalman filter to model constant-velocity or constant-acceleration motion. A linear Kalman filter assumes that the process obeys the following linear stochastic difference equation:

$$x_{k+1} = F_k x_k + G_k u_k + v_k$$

x_k is the state at step k . F_k is the state transition model matrix. G_k is the control model matrix. u_k represents known generalized controls acting on the object. In addition to the specified equations of motion, the motion may be affected by random noise perturbations, v_k . The state, the state transition matrix, and the controls together provide enough information to determine the future motion of the object in the absence of noise.

In the Kalman filter, the measurements are also linear functions of the state,

$$z_k = H_k x_k + w_k$$

where H_k is the measurement model matrix. This model expresses the measurements as functions of the state. A measurement can consist of an object position, position and velocity, or its position, velocity, and acceleration, or some function of these quantities. The measurements can also include noise perturbations, w_k .

These equations, in the absence of noise, model the actual motion of the object and the actual measurements. The noise contributions at each step are unknown and cannot be modeled. Only the noise covariance matrices are known. The state covariance matrix is updated with knowledge of the noise covariance only.

For a brief description of the linear Kalman filter algorithm, see "Linear Kalman Filters".

References

- [1] Brown, R.G. and P.Y.C. Wang. *Introduction to Random Signal Analysis and Applied Kalman Filtering*. 3rd Edition. New York: John Wiley & Sons, 1997.
- [2] Kalman, R. E. "A New Approach to Linear Filtering and Prediction Problems." *Transaction of the ASME-Journal of Basic Engineering*, Vol. 82, Series D, March 1960, pp. 35-45.
- [3] Blackman, Samuel. *Multiple-Target Tracking with Radar Applications*. Artech House. 1986.

Extended Capabilities

C/C++ Code Generation

Generate C and C++ code using MATLAB® Coder™.

Usage notes and limitations:

- When you create a `trackingKF` object, and you specify the `MotionModel` property as any value other than `'Custom'`, then you must specify the state vector explicitly at construction time using the `State` property. The choice of motion model determines the size of the state vector. However, motion models do not specify the data type, for example, double precision or single precision. Both size and data type are required for code generation.

See Also

Functions

`initcakf` | `initcvkf`

Objects

`trackerGNN` | `trackerTOMHT` | `trackingABF` | `trackingCKF` | `trackingEKF` | `trackingGSF` | `trackingIMM` | `trackingMSCEKF` | `trackingPF` | `trackingUKF`

Topics

“Linear Kalman Filters”

Introduced in R2018b

trackingEKF

Extended Kalman filter for object tracking

Description

A `trackingEKF` object is a discrete-time extended Kalman filter used to track the positions and velocities of targets and objects.

A Kalman filter is a recursive algorithm for estimating the evolving state of a process when measurements are made on the process. The extended Kalman filter can model the evolution of a state when the state follows a nonlinear motion model, when the measurements are nonlinear functions of the state, or when both conditions apply. The extended Kalman filter is based on the linearization of the nonlinear equations. This approach leads to a filter formulation similar to the linear Kalman filter, `trackingKF`.

The process and measurements can have Gaussian noise, which you can include in these ways:

- Add noise to both the process and the measurements. In this case, the sizes of the process noise and measurement noise must match the sizes of the state vector and measurement vector, respectively.
- Add noise in the state transition function, the measurement model function, or in both functions. In these cases, the corresponding noise sizes are not restricted.

Creation

Syntax

```
filter = trackingEKF
filter = trackingEKF(transitionfcn,measurementfcn,state)
filter = trackingEKF( ___,Name,Value)
```

Description

`filter = trackingEKF` creates an extended Kalman filter object for a discrete-time system by using default values for the `StateTransitionFcn`, `MeasurementFcn`, and `State` properties. The process and measurement noises are assumed to be additive.

`filter = trackingEKF(transitionfcn,measurementfcn,state)` specifies the state transition function, `transitionfcn`, the measurement function, `measurementfcn`, and the initial state of the system, `state`.

`filter = trackingEKF(___,Name,Value)` configures the properties of the extended Kalman filter object by using one or more `Name,Value` pair arguments and any of the previous syntaxes. Any unspecified properties have default values.

Properties

State — Kalman filter state

real-valued M -element vector

Kalman filter state, specified as a real-valued M -element vector, where M is the size of the filter state.

Example: [200; 0.2]

Data Types: double

StateCovariance — State estimation error covariance

positive-definite real-valued M -by- M matrix

State error covariance, specified as a positive-definite real-valued M -by- M matrix where M is the size of the filter state. The covariance matrix represents the uncertainty in the filter state.

Example: [20 0.1; 0.1 1]

StateTransitionFcn — State transition function

function handle

State transition function, specified as a function handle. This function calculates the state vector at time step k from the state vector at time step $k - 1$. The function can take additional input parameters, such as control inputs or time step size. The function can also include noise values.

The valid syntaxes for the state transition function depend on whether the filter has additive process noise. The table shows the valid syntaxes based on the value of the `HasAdditiveProcessNoise` property.

Valid Syntaxes (HasAdditiveProcessNoise = true)	Valid Syntaxes (HasAdditiveProcessNoise = false)
$x(k) = \text{statetransitionfcn}(x(k-1))$ $x(k) = \text{statetransitionfcn}(x(k-1), \text{parameters})$ <ul style="list-style-type: none"> $x(k)$ is the state at time k. <code>parameters</code> stands for all additional arguments required by the state transition function. 	$x(k) = \text{statetransitionfcn}(x(k-1), w(k-1))$ $x(k) = \text{statetransitionfcn}(x(k-1), w(k-1), dt)$ $x(k) = \text{statetransitionfcn}(_, \text{parameters})$ <ul style="list-style-type: none"> $x(k)$ is the state at time k. $w(k)$ is a value for the process noise at time k. <code>dt</code> is the time step of the <code>trackingEKF</code> filter, specified in the most recent call to the <code>predict</code> function. The <code>dt</code> argument applies when you use the filter within a tracker and call the <code>predict</code> function with the filter to predict the state of the tracker at the next time step. For the nonadditive process noise case, the tracker assumes that you explicitly specify the time step by using this syntax: <code>predict(filter, dt)</code>. <code>parameters</code> stands for all additional arguments required by the state transition function.

Example: @constacc

Data Types: `function_handle`

StateTransitionJacobianFcn — Jacobian of state transition function

function handle

Jacobian of the state transition function, specified as a function handle. This function has the same input arguments as the state transition function.

The valid syntaxes for the Jacobian of the state transition function depend on whether the filter has additive process noise. The table shows the valid syntaxes based on the value of the `HasAdditiveProcessNoise` property.

Valid Syntaxes (<code>HasAdditiveProcessNoise = true</code>)	Valid Syntaxes (<code>HasAdditiveProcessNoise = false</code>)
<code>Jx(k) = statejacobianfcn(x(k))</code> <code>Jx(k) = statejacobianfcn(x(k),parameters)</code> <ul style="list-style-type: none"> <code>x(k)</code> is the state at time <code>k</code>. <code>Jx(k)</code> denotes the Jacobian of the predicted state with respect to the previous state. This Jacobian is an M-by-M matrix at time <code>k</code>. The Jacobian function can take additional input parameters, such as control inputs or time-step size. <code>parameters</code> stands for all additional arguments required by the Jacobian function, such as control inputs or time-step size. 	<code>[Jx(k),Jw(k)] = statejacobianfcn(x(k),w(k))</code> <code>[Jx(k),Jw(k)] = statejacobianfcn(x(k),w(k),dt)</code> <code>[Jx(k),Jw(k)] = statejacobianfcn(__,parameters)</code> <ul style="list-style-type: none"> <code>x(k)</code> is the state at time <code>k</code> <code>w(k)</code> is a sample Q-element vector of the process noise at time <code>k</code>. Q is the size of the process noise covariance. The process noise vector in the nonadditive case does not need to have the same dimensions as the state vector. <code>Jx(k)</code> denotes the Jacobian of the predicted state with respect to the previous state. This Jacobian is an M-by-M matrix at time <code>k</code>. The Jacobian function can take additional input parameters, such as control inputs or time-step size. <code>Jw(k)</code> denotes the M-by-Q Jacobian of the predicted state with respect to the process noise elements. <code>dt</code> is the time step of the <code>trackingEKF</code> filter, specified in the most recent call to the <code>predict</code> function. The <code>dt</code> argument applies when you use the filter within a tracker and call the <code>predict</code> function with the filter to predict the state of the tracker at the next time step. For the nonadditive process noise case, the tracker assumes that you explicitly specify the time step by using this syntax: <code>predict(filter,dt)</code>. <code>parameters</code> stands for all additional arguments required by the Jacobian function, such as control inputs or time-step size.

If this property is not specified, the Jacobians are computed by numeric differencing at each call of the `predict` function. This computation can increase the processing time and numeric inaccuracy.

Example: `@constaccjac`

Data Types: `function_handle`

ProcessNoise — Process noise covariance

1 (default) | positive real scalar | positive-definite real-valued matrix

Process noise covariance, specified as a scalar or matrix.

- When `HasAdditiveProcessNoise` is `true`, specify the process noise covariance as a positive real scalar or a positive-definite real-valued M -by- M matrix. M is the dimension of the state vector. When specified as a scalar, the matrix is a multiple of the M -by- M identity matrix.
- When `HasAdditiveProcessNoise` is `false`, specify the process noise covariance as a Q -by- Q matrix. Q is the size of the process noise vector.

You must specify `ProcessNoise` before any call to the `predict` function. In later calls to `predict`, you can optionally specify the process noise as a scalar. In this case, the process noise matrix is a multiple of the Q -by- Q identity matrix.

Example: `[1.0 0.05; 0.05 2]`

HasAdditiveProcessNoise — Model additive process noise

`true` (default) | `false`

Option to model process noise as additive, specified as `true` or `false`. When this property is `true`, process noise is added to the state vector. Otherwise, noise is incorporated into the state transition function.

MeasurementFcn — Measurement model function

`function handle`

Measurement model function, specified as a function handle. This function can be a nonlinear function that models measurements from the predicted state. Input to the function is the M -element state vector. The output is the N -element measurement vector. The function can take additional input arguments, such as sensor position and orientation.

- If `HasAdditiveMeasurementNoise` is `true`, specify the function using one of these syntaxes:

$$z(k) = \text{measurementfcn}(x(k))$$

$$z(k) = \text{measurementfcn}(x(k), \text{parameters})$$

$x(k)$ is the state at time k and $z(k)$ is the predicted measurement at time k . The `parameters` argument stands for all additional arguments required by the measurement function.

- If `HasAdditiveMeasurementNoise` is `false`, specify the function using one of these syntaxes:

$$z(k) = \text{measurementfcn}(x(k), v(k))$$

$$z(k) = \text{measurementfcn}(x(k), v(k), \text{parameters})$$

$x(k)$ is the state at time k and $v(k)$ is the measurement noise at time k . The `parameters` argument stands for all additional arguments required by the measurement function.

Example: `@cameas`

Data Types: `function_handle`

MeasurementJacobianFcn — Jacobian of measurement function

`function handle`

Jacobian of the measurement function, specified as a function handle. The function has the same input arguments as the measurement function. The function can take additional input parameters, such as sensor position and orientation.

- If `HasAdditiveMeasurementNoise` is `true`, specify the Jacobian function using one of these syntaxes:

```
Jmx(k) = measjacobianfcn(x(k))
```

```
Jmx(k) = measjacobianfcn(x(k),parameters)
```

$x(k)$ is the state at time k . $Jx(k)$ denotes the N -by- M Jacobian of the measurement function with respect to the state. The `parameters` argument stands for all arguments required by the measurement function.

- If `HasAdditiveMeasurementNoise` is `false`, specify the Jacobian function using one of these syntaxes:

```
[Jmx(k),Jmv(k)] = measjacobianfcn(x(k),v(k))
```

```
[Jmx(k),Jmv(k)] = measjacobianfcn(x(k),v(k),parameters)
```

$x(k)$ is the state at time k and $v(k)$ is an R -dimensional sample noise vector. $Jmx(k)$ denotes the N -by- M Jacobian of the measurement function with respect to the state. $Jmv(k)$ denotes the Jacobian of the N -by- R measurement function with respect to the measurement noise. The `parameters` argument stands for all arguments required by the measurement function.

If not specified, measurement Jacobians are computed using numerical differencing at each call to the `correct` function. This computation can increase processing time and numerical inaccuracy.

Example: `@cameasjac`

Data Types: `function_handle`

MeasurementNoise — Measurement noise covariance

1 (default) | positive scalar | positive-definite real-valued matrix

Measurement noise covariance, specified as a positive scalar or positive-definite real-valued matrix.

- When `HasAdditiveMeasurementNoise` is `true`, specify the measurement noise covariance as a scalar or an N -by- N matrix. N is the size of the measurement vector. When specified as a scalar, the matrix is a multiple of the N -by- N identity matrix.
- When `HasAdditiveMeasurementNoise` is `false`, specify the measurement noise covariance as an R -by- R matrix. R is the size of the measurement noise vector.

You must specify `MeasurementNoise` before any call to the `correct` function. After the first call to `correct`, you can optionally specify the measurement noise as a scalar. In this case, the measurement noise matrix is a multiple of the R -by- R identity matrix.

Example: `0.2`

HasAdditiveMeasurementNoise — Model additive measurement noise

`true` (default) | `false`

Option to enable additive measurement noise, specified as `true` or `false`. When this property is `true`, noise is added to the measurement. Otherwise, noise is incorporated into the measurement function.

EnableSmoothing — Enable state smoothing

false (default) | true

Enable state smoothing, specified as `false` or `true`. Setting this property to `true` requires the Sensor Fusion and Tracking Toolbox license. When specified as `true`, you can:

- Use the `smooth` function, provided in Sensor Fusion and Tracking Toolbox, to smooth state estimates in the previous steps. Internally, the filter stores the results from previous steps to allow backward smoothing.
- Specify the maximum number of smoothing steps using the `MaxNumSmoothingSteps` property of the tracking filter.

MaxNumSmoothingSteps — Maximum number of smoothing steps

5 (default) | positive integer

Maximum number of backward smoothing steps, specified as a positive integer.

Dependencies

To enable this property, set the `EnableSmoothing` property to `true`.

Object Functions

<code>predict</code>	Predict state and state estimation error covariance of tracking filter
<code>correct</code>	Correct state and state estimation error covariance using tracking filter
<code>correctjpda</code>	Correct state and state estimation error covariance using tracking filter and JPDA
<code>distance</code>	Distances between current and predicted measurements of tracking filter
<code>likelihood</code>	Likelihood of measurement from tracking filter
<code>clone</code>	Create duplicate tracking filter
<code>smooth</code>	Backward smooth state estimates of tracking filter
<code>residual</code>	Measurement residual and residual noise from tracking filter
<code>initialize</code>	Initialize state and covariance of tracking filter

Examples**Constant-Velocity Extended Kalman Filter**

Create a two-dimensional trackingEKF object and use name-value pairs to define the `StateTransitionJacobianFcn` and `MeasurementJacobianFcn` properties. Use the predefined constant-velocity motion and measurement models and their Jacobians.

```
EKF = trackingEKF(@constvel,@cvmeas,[0;0;0;0], ...
    'StateTransitionJacobianFcn',@constveljac, ...
    'MeasurementJacobianFcn',@cvmeasjac);
```

Run the filter. Use the `predict` and `correct` functions to propagate the state. You may call `predict` and `correct` in any order and as many times you want. Specify the measurement in Cartesian coordinates.

```
measurement = [1;1;0];
[xpred, Ppred] = predict(EKF);
[xcorr, Pcorr] = correct(EKF,measurement);
[xpred, Ppred] = predict(EKF);
[xpred, Ppred] = predict(EKF);
```

$x_{pred} = 4 \times 1$

```
1.2500
0.2500
1.2500
0.2500
```

$P_{pred} = 4 \times 4$

```
11.7500  4.7500  0  0
 4.7500  3.7500  0  0
 0  0  11.7500  4.7500
 0  0  4.7500  3.7500
```

More About

Filter Parameters

This table relates the filter model parameters to the object properties. M is the size of the state vector. N is the size of the measurement vector.

Filter Parameter	Description	Filter Property	Size
f	State transition function that specifies the equations of motion of the object. This function determines the state at time $k+1$ as a function of the state and the controls at time k . The state transition function depends on the time-increment of the filter.	StateTransitionFcn	Function returns M -element vector
h	Measurement function that specifies how the measurements are functions of the state and measurement noise.	MeasurementFcn	Function returns N -element vector
x_k	Estimate of the object state.	State	M -element vector
P_k	State error covariance matrix representing the uncertainty in the values of the state.	StateCovariance	M -by- M matrix

Filter Parameter	Description	Filter Property	Size
Q_k	Estimate of the process noise covariance matrix at step k. Process noise is a measure of the uncertainty in the dynamic model. It is assumed to be zero-mean white Gaussian noise.	ProcessNoise	M -by- M matrix when HasAdditiveProcessNoise is true. Q -by- Q matrix when HasAdditiveProcessNoise is false
R_k	Estimate of the measurement noise covariance at step k. Measurement noise reflects the uncertainty of the measurement. It is assumed to be zero-mean white Gaussian noise.	MeasurementNoise	N -by- N matrix when HasAdditiveMeasurementNoise is true. R -by- R when HasAdditiveMeasurementNoise is false.
F	Function determining Jacobian of propagated state with respect to previous state.	StateTransitionJacobianFcn	M -by- M matrix
H	Function determining Jacobians of measurement with respect to the state and measurement noise.	MeasurementJacobianFcn	N -by- M for state vector Jacobian and N -by- R for measurement vector Jacobian

Algorithms

The extended Kalman filter estimates the state of a process governed by this nonlinear stochastic equation:

$$x_{k+1} = f(x_k, u_k, w_k, t)$$

x_k is the state at step k . $f()$ is the state transition function. Random noise perturbations, w_k , can affect the object motion. The filter also supports a simplified form,

$$x_{k+1} = f(x_k, u_k, t) + w_k$$

To use the simplified form, set HasAdditiveProcessNoise to true.

In the extended Kalman filter, the measurements are also general functions of the state:

$$z_k = h(x_k, v_k, t)$$

$h(x_k, v_k, t)$ is the measurement function that determines the measurements as functions of the state. Typical measurements are position and velocity or some function of position and velocity. The measurements can also include noise, represented by v_k . Again, the filter offers a simpler formulation.

$$z_k = h(x_k, t) + v_k$$

To use the simplified form, set `HasAdditiveMeasurementNoise` to `true`.

These equations represent the actual motion and the actual measurements of the object. However, the noise contribution at each step is unknown and cannot be modeled deterministically. Only the statistical properties of the noise are known.

References

- [1] Brown, R.G. and P.Y.C. Wang. *Introduction to Random Signal Analysis and Applied Kalman Filtering*. 3rd Edition. New York: John Wiley & Sons, 1997.
- [2] Kalman, R. E. "A New Approach to Linear Filtering and Prediction Problems." *Transactions of the ASME-Journal of Basic Engineering*. Vol. 82, Series D, March 1960, pp. 35-45.
- [3] Blackman, Samuel and R. Popoli. *Design and Analysis of Modern Tracking Systems*. Artech House.1999.
- [4] Blackman, Samuel. *Multiple-Target Tracking with Radar Applications*. Artech House. 1986.

Extended Capabilities

C/C++ Code Generation

Generate C and C++ code using MATLAB® Coder™.

See Also

Functions

cameas | cameasjac | constacc | constaccjac | constturn | constturnjac | constvel | constveljac | ctmeas | ctmeasjac | cvmeas | cvmeasjac | initcaekf | initctekf | initcvekf

Objects

trackerGNN | trackerTOMHT | trackingABF | trackingCKF | trackingGSF | trackingIMM | trackingKF | trackingMSCEKF | trackingPF | trackingUKF

Topics

"Extended Kalman Filters"

Introduced in R2018b

trackingUKF

Unscented Kalman filter for object tracking

Description

The `trackingUKF` object is a discrete-time unscented Kalman filter used to track the positions and velocities of targets and objects.

An unscented Kalman filter is a recursive algorithm for estimating the evolving state of a process when measurements are made on the process. The unscented Kalman filter can model the evolution of a state that obeys a nonlinear motion model. The measurements can also be nonlinear functions of the state, and the process and measurements can have noise.

Use an unscented Kalman filter when one of both of these conditions apply:

- The current state is a nonlinear function of the previous state.
- The measurements are nonlinear functions of the state.

The unscented Kalman filter estimates the uncertainty about the state, and its propagation through the nonlinear state and measurement equations, by using a fixed number of sigma points. Sigma points are chosen by using the unscented transformation, as parameterized by the Alpha, Beta, and Kappa properties.

Creation

Syntax

```
filter = trackingUKF
filter = trackingUKF(transitionfcn,measurementfcn,state)
filter = trackingUKF( ____,Name,Value)
```

Description

`filter = trackingUKF` creates an unscented Kalman filter object for a discrete-time system by using default values for the `StateTransitionFcn`, `MeasurementFcn`, and `State` properties. The process and measurement noises are assumed to be additive.

`filter = trackingUKF(transitionfcn,measurementfcn,state)` specifies the state transition function, `transitionfcn`, the measurement function, `measurementfcn`, and the initial state of the system, `state`.

`filter = trackingUKF(____,Name,Value)` configures the properties of the unscented Kalman filter object using one or more `Name, Value` pair arguments and any of the previous syntaxes. Any unspecified properties have default values.

Properties

State — Kalman filter state

real-valued M -element vector

Kalman filter state, specified as a real-valued M -element vector, where M is the size of the filter state.

Example: [200; 0.2]

Data Types: double

StateCovariance — State estimation error covariance

positive-definite real-valued M -by- M matrix

State error covariance, specified as a positive-definite real-valued M -by- M matrix where M is the size of the filter state. The covariance matrix represents the uncertainty in the filter state.

Example: [20 0.1; 0.1 1]

StateTransitionFcn — State transition function

function handle

State transition function, specified as a function handle. This function calculates the state vector at time step k from the state vector at time step $k - 1$. The function can take additional input parameters, such as control inputs or time step size. The function can also include noise values.

The valid syntaxes for the state transition function depend on whether the filter has additive process noise. The table shows the valid syntaxes based on the value of the `HasAdditiveProcessNoise` property.

Valid Syntaxes (HasAdditiveProcessNoise = true)	Valid Syntaxes (HasAdditiveProcessNoise = false)
$x(k) = \text{statetransitionfcn}(x(k-1))$ $x(k) = \text{statetransitionfcn}(x(k-1), \text{parameters})$ <ul style="list-style-type: none"> $x(k)$ is the state at time k. <code>parameters</code> stands for all additional arguments required by the state transition function. 	$x(k) = \text{statetransitionfcn}(x(k-1), w(k-1))$ $x(k) = \text{statetransitionfcn}(x(k-1), w(k-1), dt)$ $x(k) = \text{statetransitionfcn}(_, \text{parameters})$ <ul style="list-style-type: none"> $x(k)$ is the state at time k. $w(k)$ is a value for the process noise at time k. dt is the time step of the trackingUKF filter, specified in the most recent call to the <code>predict</code> function. The <code>dt</code> argument applies when you use the filter within a tracker and call the <code>predict</code> function with the filter to predict the state of the tracker at the next time step. For the nonadditive process noise case, the tracker assumes that you explicitly specify the time step by using this syntax: <code>predict(filter, dt)</code>. <code>parameters</code> stands for all additional arguments required by the state transition function.

Example: @constacc

Data Types: `function_handle`

ProcessNoise — Process noise covariance

1 (default) | positive real scalar | positive-definite real-valued matrix

Process noise covariance, specified as a scalar or matrix.

- When `HasAdditiveProcessNoise` is `true`, specify the process noise covariance as a positive real scalar or a positive-definite real-valued M -by- M matrix. M is the dimension of the state vector. When specified as a scalar, the matrix is a multiple of the M -by- M identity matrix.
- When `HasAdditiveProcessNoise` is `false`, specify the process noise covariance as a Q -by- Q matrix. Q is the size of the process noise vector.

You must specify `ProcessNoise` before any call to the `predict` function. In later calls to `predict`, you can optionally specify the process noise as a scalar. In this case, the process noise matrix is a multiple of the Q -by- Q identity matrix.

Example: `[1.0 0.05; 0.05 2]`

HasAdditiveProcessNoise — Model additive process noise

`true` (default) | `false`

Option to model process noise as additive, specified as `true` or `false`. When this property is `true`, process noise is added to the state vector. Otherwise, noise is incorporated into the state transition function.

MeasurementFcn — Measurement model function

`function handle`

Measurement model function, specified as a function handle. This function can be a nonlinear function that models measurements from the predicted state. Input to the function is the M -element state vector. The output is the N -element measurement vector. The function can take additional input arguments, such as sensor position and orientation.

- If `HasAdditiveMeasurementNoise` is `true`, specify the function using one of these syntaxes:

$$z(k) = \text{measurementfcn}(x(k))$$

$$z(k) = \text{measurementfcn}(x(k), \text{parameters})$$

$x(k)$ is the state at time k and $z(k)$ is the predicted measurement at time k . The `parameters` argument stands for all additional arguments required by the measurement function.

- If `HasAdditiveMeasurementNoise` is `false`, specify the function using one of these syntaxes:

$$z(k) = \text{measurementfcn}(x(k), v(k))$$

$$z(k) = \text{measurementfcn}(x(k), v(k), \text{parameters})$$

$x(k)$ is the state at time k and $v(k)$ is the measurement noise at time k . The `parameters` argument stands for all additional arguments required by the measurement function.

Example: `@cameas`

Data Types: `function_handle`

MeasurementNoise — Measurement noise covariance

1 (default) | positive scalar | positive-definite real-valued matrix

Measurement noise covariance, specified as a positive scalar or positive-definite real-valued matrix.

- When `HasAdditiveMeasurementNoise` is `true`, specify the measurement noise covariance as a scalar or an N -by- N matrix. N is the size of the measurement vector. When specified as a scalar, the matrix is a multiple of the N -by- N identity matrix.
- When `HasAdditiveMeasurementNoise` is `false`, specify the measurement noise covariance as an R -by- R matrix. R is the size of the measurement noise vector.

You must specify `MeasurementNoise` before any call to the `correct` function. After the first call to `correct`, you can optionally specify the measurement noise as a scalar. In this case, the measurement noise matrix is a multiple of the R -by- R identity matrix.

Example: `0.2`

HasAdditiveMeasurementNoise — Model additive measurement noise

`true` (default) | `false`

Option to enable additive measurement noise, specified as `true` or `false`. When this property is `true`, noise is added to the measurement. Otherwise, noise is incorporated into the measurement function.

Alpha — Sigma point spread around state

`1.0e-3` (default) | positive scalar greater than 0 and less than or equal to 1

Sigma point spread around state, specified as a positive scalar greater than 0 and less than or equal to 1.

Beta — Distribution of sigma points

`2` (default) | nonnegative scalar

Distribution of sigma points, specified as a nonnegative scalar. This parameter incorporates knowledge of the noise distribution of states for generating sigma points. For Gaussian distributions, setting `Beta` to 2 is optimal.

Kappa — Secondary scaling factor for generating sigma points

`0` (default) | scalar from 0 to 3

Secondary scaling factor for generation of sigma points, specified as a scalar from 0 to 3. This parameter helps specify the generation of sigma points.

EnableSmoothing — Enable state smoothing

`false` (default) | `true`

Enable state smoothing, specified as `false` or `true`. Setting this property to `true` requires the Sensor Fusion and Tracking Toolbox license. When specified as `true`, you can:

- Use the `smooth` function, provided in Sensor Fusion and Tracking Toolbox, to smooth state estimates in the previous steps. Internally, the filter stores the results from previous steps to allow backward smoothing.
- Specify the maximum number of smoothing steps using the `MaxNumSmoothingSteps` property of the tracking filter.

MaxNumSmoothingSteps — Maximum number of smoothing steps

`5` (default) | positive integer

Maximum number of backward smoothing steps, specified as a positive integer.

Dependencies

To enable this property, set the `EnableSmoothing` property to `true`.

Object Functions

<code>predict</code>	Predict state and state estimation error covariance of tracking filter
<code>correct</code>	Correct state and state estimation error covariance using tracking filter
<code>correctjpda</code>	Correct state and state estimation error covariance using tracking filter and JPDA
<code>distance</code>	Distances between current and predicted measurements of tracking filter
<code>likelihood</code>	Likelihood of measurement from tracking filter
<code>clone</code>	Create duplicate tracking filter
<code>residual</code>	Measurement residual and residual noise from tracking filter
<code>smooth</code>	Backward smooth state estimates of tracking filter
<code>initialize</code>	Initialize state and covariance of tracking filter

Examples

Constant-Velocity Unscented Kalman Filter

Create a `trackingUKF` object using the predefined constant-velocity motion model, `constvel`, and the associated measurement model, `cvmeas`. These models assume that the state vector has the form $[x;v_x;y;v_y]$ and that the position measurement is in Cartesian coordinates, $[x;y;z]$. Set the sigma point spread property to $1e-2$.

```
filter = trackingUKF(@constvel,@cvmeas,[0;0;0;0], 'Alpha',1e-2);
```

Run the filter. Use the `predict` and `correct` functions to propagate the state. You can call `predict` and `correct` in any order and as many times as you want.

```
meas = [1;1;0];  
[xpred, Ppred] = predict(filter);  
[xcorr, Pcorr] = correct(filter,meas);  
[xpred, Ppred] = predict(filter);  
[xpred, Ppred] = predict(filter)
```

```
xpred = 4×1
```

```
1.2500  
0.2500  
1.2500  
0.2500
```

```
Ppred = 4×4
```

```
11.7500    4.7500   -0.0000    0.0000  
 4.7500    3.7500    0.0000   -0.0000  
-0.0000    0.0000   11.7500    4.7500  
 0.0000   -0.0000    4.7500    3.7500
```

More About

Filter Parameters

This table relates the filter model parameters to the object properties. M is the size of the state vector. N is the size of the measurement vector.

Model Parameter	Description	Filter Property	Size
f	State transition function that specifies the equations of motion of the object. This function determines the state at time $k+1$ as a function of the state and the controls at time k . The state transition function depends on the time-increment of the filter.	StateTransitionFcn	Function returns M -element vector
h	Measurement function that specifies how the measurements are functions of the state and measurement noise.	MeasurementFcn	Function returns N -element vector
x_k	Estimate of the object state.	State	M
P_k	State error covariance matrix representing the uncertainty in the values of the state	StateCovariance	M -by- M
Q_k	Estimate of the process noise covariance matrix at step k . Process noise is measure of the uncertainty in your dynamic model and is assumed to be zero-mean white Gaussian noise	ProcessNoise	M -by- M when HasAdditiveProcessNoise is true. Q -by- Q when HasAdditiveProcessNoise is false.
R_k	Estimate of the measurement noise covariance at step k . Measurement noise reflects the uncertainty of the measurement and is assumed to be zero-mean white Gaussian noise.	MeasurementNoise	N -by- N when HasAdditiveMeasurementNoise is true. R -by- R when HasAdditiveMeasurementNoise is false.

Model Parameter	Description	Filter Property	Size
α	Determines spread of sigma points.	Alpha	scalar
β	<i>A priori</i> knowledge of sigma point distribution.	Beta	scalar
κ	Secondary scaling parameter.	Kappa	scalar

Algorithms

The unscented Kalman filter estimates the state of a process governed by a nonlinear stochastic equation

$$x_{k+1} = f(x_k, u_k, w_k, t)$$

where x_k is the state at step k . $f()$ is the state transition function, u_k are the controls on the process. The motion may be affected by random noise perturbations, w_k . The filter also supports a simplified form,

$$x_{k+1} = f(x_k, u_k, t) + w_k$$

To use the simplified form, set `HasAdditiveProcessNoise` to `true`.

In the unscented Kalman filter, the measurements are also general functions of the state,

$$z_k = h(x_k, v_k, t)$$

where $h(x_k, v_k, t)$ is the measurement function that determines the measurements as functions of the state. Typical measurements are position and velocity or some function of these. The measurements can include noise as well, represented by v_k . Again the class offers a simpler formulation

$$z_k = h(x_k, t) + v_k$$

To use the simplified form, set `HasAdditiveMeasurementNoise` to `true`.

These equations represent the actual motion of the object and the actual measurements. However, the noise contribution at each step is unknown and cannot be modeled exactly. Only statistical properties of the noise are known.

References

- [1] Brown, R.G. and P.Y.C. Wang. *Introduction to Random Signal Analysis and Applied Kalman Filtering*. 3rd Edition. New York: John Wiley & Sons, 1997.
- [2] Kalman, R. E. "A New Approach to Linear Filtering and Prediction Problems." *Transactions of the ASME-Journal of Basic Engineering*. Vol. 82, Series D, March 1960, pp. 35-45.
- [3] Wan, Eric A. and R. van der Merwe. "The Unscented Kalman Filter for Nonlinear Estimation". *Adaptive Systems for Signal Processing, Communications, and Control*. AS-SPCC, IEEE, 2000, pp.153-158.
- [4] Wan, Merle. "The Unscented Kalman Filter." In *Kalman Filtering and Neural Networks*. Edited by Simon Haykin. John Wiley & Sons, Inc., 2001.

[5] Sarkka S. "Recursive Bayesian Inference on Stochastic Differential Equations." Doctoral Dissertation. Helsinki University of Technology, Finland. 2006.

[6] Blackman, Samuel. *Multiple-Target Tracking with Radar Applications*. Artech House, 1986.

Extended Capabilities

C/C++ Code Generation

Generate C and C++ code using MATLAB® Coder™.

Usage notes and limitations:

- Generated code uses an algorithm that is different from the algorithm that the `trackingUKF` object uses. You might see some numerical differences in the results obtained using the two methods.

See Also

Functions

`cameas` | `cameasjac` | `constacc` | `constaccjac` | `constturn` | `constturnjac` | `constvel` | `constveljac` | `ctmeas` | `ctmeasjac` | `cvmeas` | `cvmeasjac` | `initcaukf` | `initctukf` | `initcvukf`

Objects

`trackerGNN` | `trackerTOMHT` | `trackingABF` | `trackingCKF` | `trackingEKF` | `trackingGSF` | `trackingIMM` | `trackingKF` | `trackingMSCEKF` | `trackingPF`

Introduced in R2018b

smooth

Backward smooth state estimates of tracking filter

Syntax

```
[smoothX,smoothP] = smooth(filter)
[smoothX,smoothP] = smooth(filter,numBackSteps)
```

Description

`[smoothX,smoothP] = smooth(filter)` runs a backward recursion to obtain smoothed states and covariances at the previous steps for a tracking filter, `filter`. The function determines the number of backward steps based on the number of executed forward steps F and the maximum number of backward steps MB specified by the `MaxNumSmoothingSteps` property of the `filter`. If $F < MB$, the number of backward steps is $F - 1$. Otherwise, the number of backward steps is MB .

The number of forward steps is equal to the number of calls to the `predict` object function of the `filter`. The backward steps do not include the current time step of the filter.

`[smoothX,smoothP] = smooth(filter,numBackSteps)` specifies the number of backward smoothing steps `numBackSteps`. The value of `numBackSteps` must be less than or equal to the smaller of $F - 1$ and MB , where F is the number of executed forward steps and MB is the maximum number of backward steps specified by the `MaxNumSmoothingSteps` property of the `filter`.

Examples

Fixed-Interval Smoothing for trackingEKF

Create a truth trajectory based on a constant turn motion model and generate 2-D position measurements.

```
rng(2020); % For repeatable results
% Initialization
dt = 1;
simTime = 50;
tspan = 0:dt:simTime;
trueInitialState = [0; 1; 0; 1; 5]; % [x;vx;y;vy;omega]
processNoise = diag([0.5; 0.5; 0.1]); % process noise matrix
measureNoise = diag([4 4 1]); % measurement noise matrix

numSteps = length(tspan);
trueStates = NaN(5,numSteps);
trueStates(:,1) = trueInitialState;

% Propagate the constant turn model and generate the measurements with
% noise.
for i = 2:length(tspan)
    trueStates(:,i) = constturn(trueStates(:,i-1),chol(processNoise)*randn(3,1),dt);
```

```
end
measurements = ctmeas(trueStates) + chol(measureNoise)*randn(3,numSteps);
```

Plot the truth trajectory and the measurements.

```
figure
plot(trueStates(1,1),trueStates(3,1),'r*','HandleVisibility','off')
hold on
plot(trueStates(1,:),trueStates(3,:),'r','DisplayName','Truth')
plot(measurements(1,:),measurements(2,:),'ko','DisplayName','Measurements')
xlabel('x (m)')
ylabel('y (m)')
axis image
```

Create a trackingEKF filter object based on the constant turn motion model.

```
initialGuess = [measurements(1,1);- 1; measurements(2,1); -1; 0];
filter = trackingEKF(@constturn,@ctmeas,initialGuess, ...
    'StateCovariance', diag([1,1,1,1,10]), ...
    'StateTransitionJacobianFcn',@constturnjac, ...
    'MeasurementNoise',measureNoise, ...
    'MeasurementJacobianFcn',@ctmeasjac, ...
    'EnableSmoothing',true, ...
    'MaxNumSmoothingSteps',numSteps);
```

```
estimateStates = NaN(size(trueStates));
estimateStates(:,1) = filter.State;
```

Propagate the filter and update the estimated state with the measurements.

```
for i=2:length(tspan)
    predict(filter,dt)
    estimateStates(:,i) = correct(filter,measurements(:,i));
end
```

Visualize the estimated results.

```
plot(estimateStates(1,:),estimateStates(3,:),'b','DisplayName','Forward filtering')
```

Backward smooth the estimated states.

```
smoothStates = smooth(filter);
```

Visualize the smoothed trajectory.

```
plot(smoothStates(1,:),smoothStates(3,:),'g','DisplayName','Backward smoothing')
legend('Location','best')
```

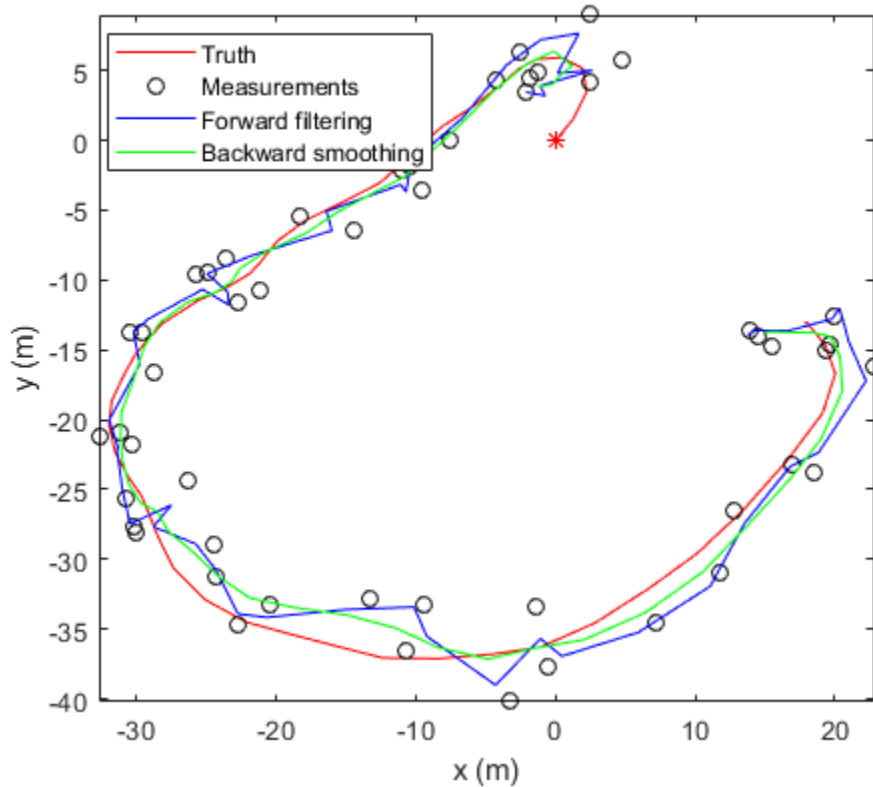

Obtain the estimation errors.

```
forwardError = abs(estimateStates - trueStates);
smoothError = abs(smoothStates - trueStates(:,1:end-1));
rmsForward = sqrt(mean(forwardError'.^2))
```

```
rmsForward = 1x5
```

```
    1.6492    1.2326    1.6138    1.1619    5.0195
```

```
rmsSmooth = sqrt(mean(smoothError'.^2))
```

```
rmsSmooth = 1x5
```

```
    0.9201    0.6587    1.2122    0.6139    2.2426
```

Visualize the estimation errors. From the results, the smoothing process reduces the estimation errors.

```
figure
subplot(2,1,1)
plot(tspan,forwardError(1,:), 'b')
hold on;
plot(tspan(1:end-1),smoothError(1,:), 'g')
title('Position Errors')
legend('Forward filtering','Backward smoothing')
```



```

ylabel('x error (m)')
subplot(2,1,2)
plot(tspan,forwardError(3,:), 'b')
hold on
plot(tspan(1:end-1),smoothError(3,:), 'g')
xlabel('time (sec)')
ylabel('y error (m)')

```

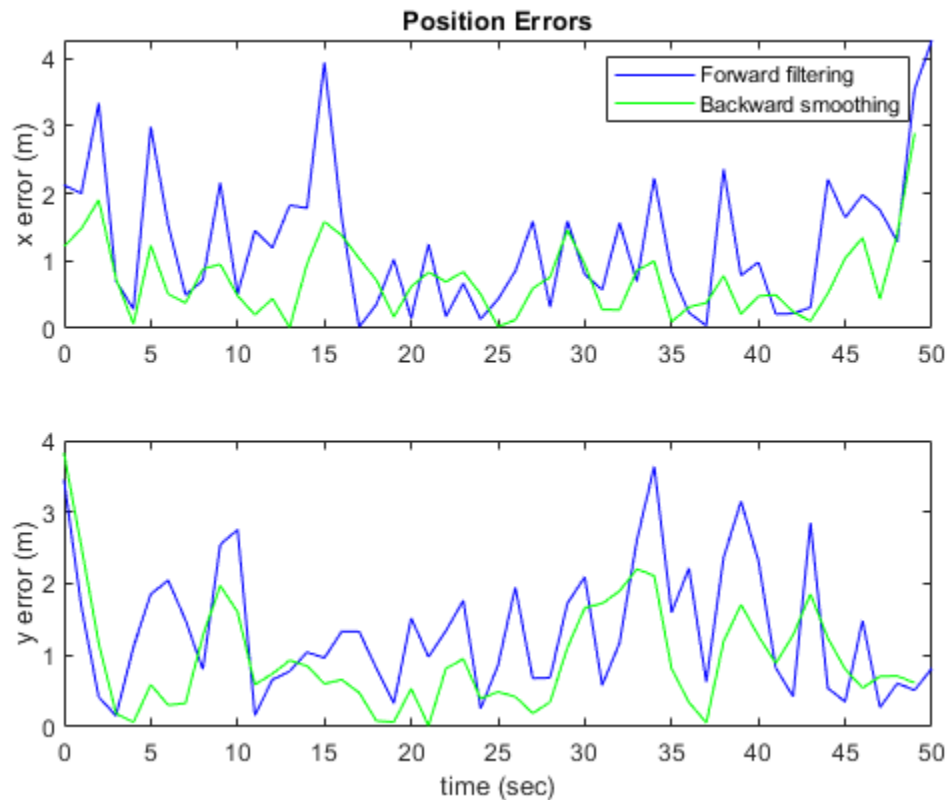

```

figure
subplot(3,1,1)
plot(tspan,forwardError(2,:), 'b')
hold on;
plot(tspan(1:end-1),smoothError(2,:), 'g')
title('Velocity Errors')
legend('Forward filtering', 'Backward smoothing')
ylabel('v_x error (m/s)')
subplot(3,1,2)
plot(tspan,forwardError(4,:), 'b')
hold on;
plot(tspan(1:end-1),smoothError(4,:), 'g')
xlabel('time (sec)')
ylabel('v_y error (m/s)')
subplot(3,1,3)
plot(tspan,forwardError(5,:), 'b')
hold on;
plot(tspan(1:end-1),smoothError(5,:), 'g')

```

```
xlabel('time (sec)')
ylabel('\omega-error (deg/s)')
```

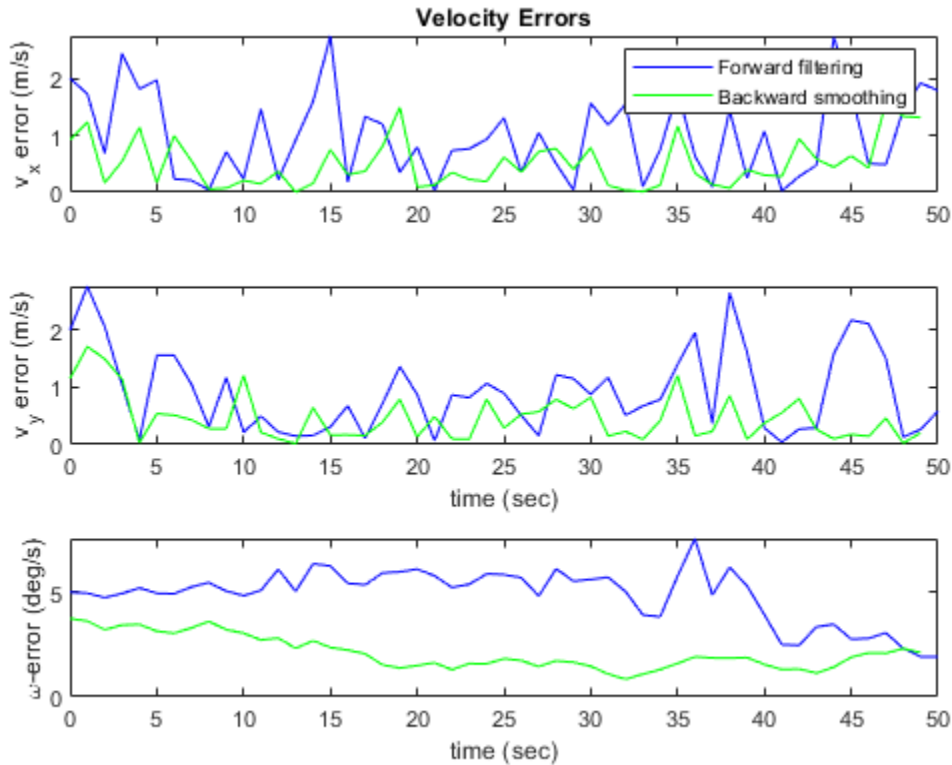

Fixed-Lag Smoothing of trackingEKF

Create a truth trajectory based on a constant turn motion model and generate 2-D position measurements.

```
rng(2020); % For repeatable results
% Initialization
dt = 1;
simTime = 50;
tspan = 0:dt:simTime;
trueInitialState = [0; 1; 0; 1; 5]; % [x;vx;y;vy;omega]
processNoise = diag([0.5; 0.5; 0.1]); % process noise matrix
measureNoise = diag([4 4 1]); % measurement noise matrix

numSteps = length(tspan);
trueStates = NaN(5,numSteps);
trueStates(:,1) = trueInitialState;

% Propagate the constant turn model and generate the measurements with
% noise.
for i = 2:length(tspan)
```

```

    trueStates(:,i) = constturn(trueStates(:,i-1),chol(processNoise)*randn(3,1),dt);
end
measurements = ctmeas(trueStates) + chol(measureNoise)*randn(3,numSteps);

```

Plot the truth trajectory and the measurements.

```

figure
plot(trueStates(1,1),trueStates(3,1),'r*','HandleVisibility','off')
hold on;
plot(trueStates(1,:),trueStates(3,:),'r','DisplayName','Truth')
plot(measurements(1,:),measurements(2,:),'ko','DisplayName','Measurements')
xlabel('x (m)')
ylabel('y (m)')
axis image;

```

Create a trackingEKF filter object based on the constant turn motion model. Set the smoothing lag to three steps.

```

initialGuess = [measurements(1,1);-1;measurements(2,1);-1;0];
filter = trackingEKF(@constturn,@ctmeas,initialGuess,...
    'StateCovariance', diag([1,1,1,1,10]),...
    'StateTransitionJacobianFcn',@constturnjac,...
    'MeasurementNoise', measureNoise,...
    'MeasurementJacobianFcn',@ctmeasjac,...
    'EnableSmoothing',true,...
    'MaxNumSmoothingSteps',4);

estimateStates = NaN(size(trueStates));
estimateStates(:,1) = filter.State;
stepLag = 3; % Smoothing lag steps
smoothStates = NaN(5,numSteps-stepLag);

```

Propagate the filter and update the estimated state with the measurements.

```

for i = 2:length(tspan)
    predict(filter,dt);
    estimateStates(:,i) = correct(filter,measurements(:,i));
    if i > 3
        smoothSegment = smooth(filter,stepLag);
        smoothStates(:,i-3) = smoothSegment(:,1);
    end
end
end

```

Visualize the forward estimated and the smoothed trajectories.

```

plot(estimateStates(1,:),estimateStates(3,:),'b','DisplayName','Forward filtering')
plot(smoothStates(1,:),smoothStates(3,:),'g','DisplayName','Backward smoothing')
legend('Location','best')

```

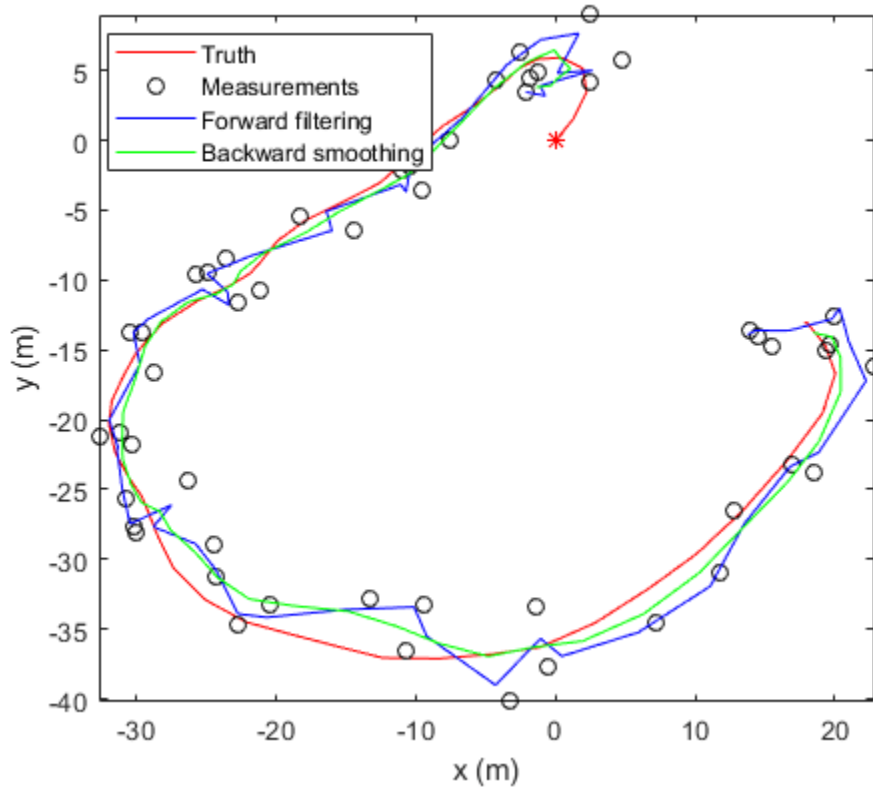

Obtain the estimation errors.

```
forwardError = abs(estimateStates - trueStates);
smoothError = abs(smoothStates - trueStates(:,1:end-stepLag));
rmsForward = sqrt(mean(forwardError'.^2))

rmsForward = 1x5
```

```
    1.6492    1.2326    1.6138    1.1619    5.0195
```

Visualize the estimation errors. From the results, the smoothing process reduces the estimation errors.

```
figure
subplot(2,1,1)
plot(tspan,forwardError(1,:), 'b')
hold on
plot(tspan(1:end-stepLag),smoothError(1,:), 'g')
title('Position Errors')
legend('Forward filtering', 'Backward smoothing')
ylabel('x error (m)')
subplot(2,1,2)
plot(tspan,forwardError(3,:), 'b')
hold on
plot(tspan(1:end-stepLag),smoothError(3,:), 'g')
xlabel('time (sec)')
ylabel('y error (m)')
```

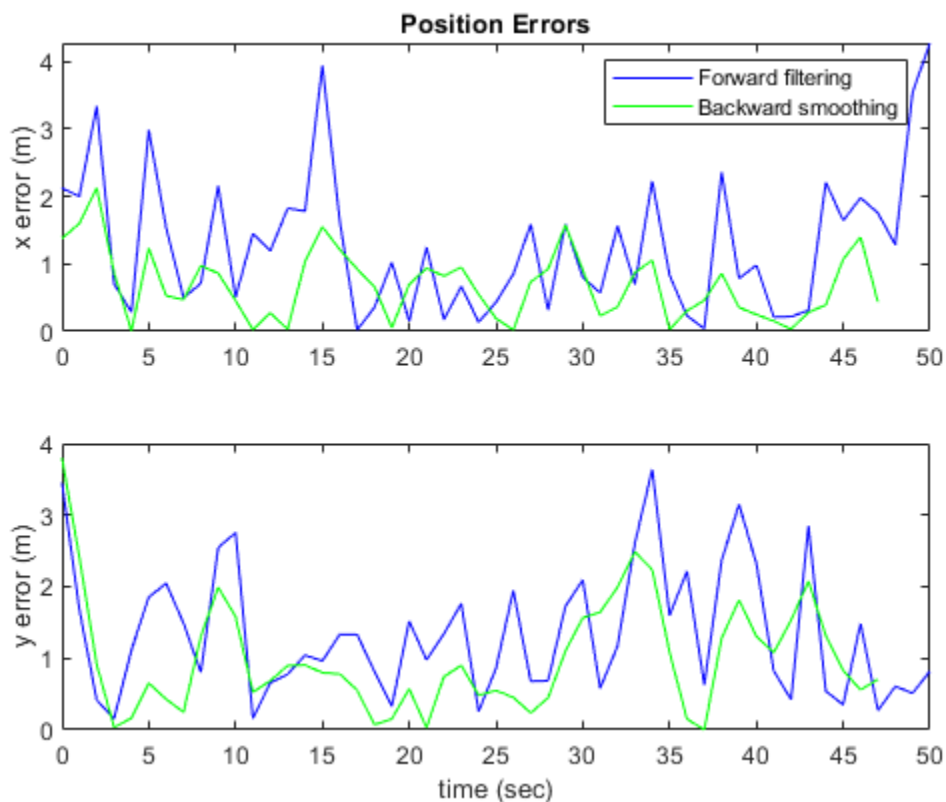

```

figure()
subplot(3,1,1)
plot(tspan,forwardError(2,:), 'b')
hold on;
plot(tspan(1:end-stepLag),smoothError(2,:), 'g')
title('Velocity Errors')
legend('Forward filtering', 'Backward smoothing')
ylabel('v_x error (m/s)')
subplot(3,1,2)
plot(tspan,forwardError(4,:), 'b')
hold on;
plot(tspan(1:end-stepLag),smoothError(4,:), 'g')
xlabel('time (sec)')
ylabel('v_y error (m/s)')
subplot(3,1,3)
plot(tspan,forwardError(5,:), 'b')
hold on;
plot(tspan(1:end-stepLag),smoothError(5,:), 'g')
xlabel('time (sec)')
ylabel('\omega-error (deg/s)')

```

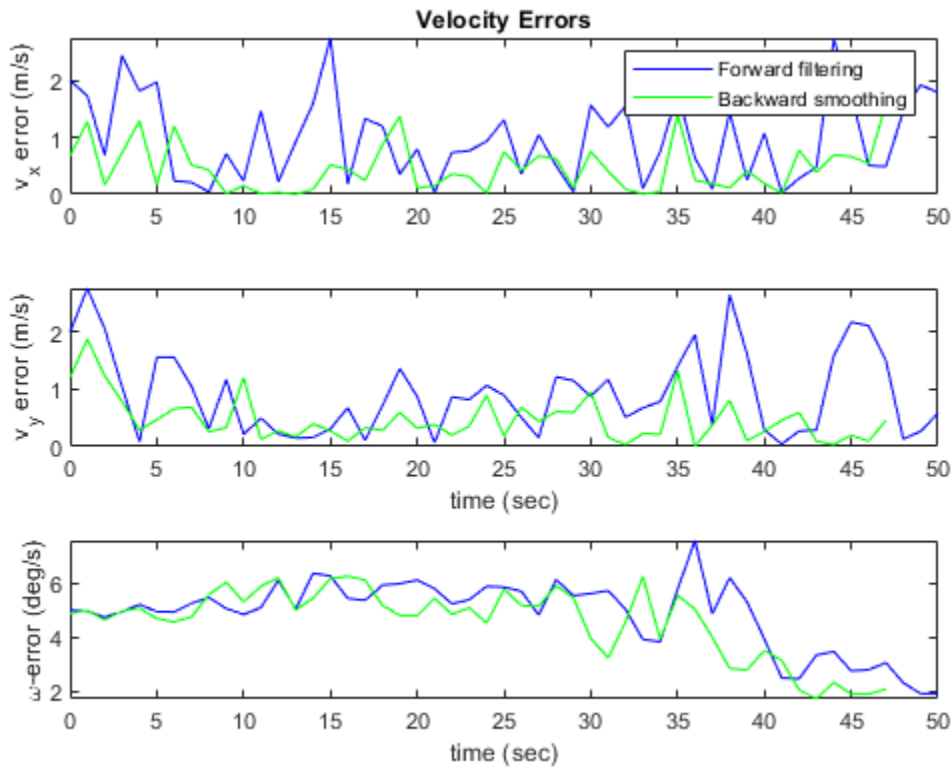

Input Arguments

filter — Filter for object tracking

tracking filter object

Filter for object tracking, specified as one of these objects:

- `trackingABF` — Alpha-beta filter
- `trackingKF` — Linear Kalman filter
- `trackingEKF` — Extended Kalman filter
- `trackingUKF` — Unscented Kalman filter
- `trackingCKF` — Cubature Kalman filter
- `trackingMSCKF` — Extended Kalman filter using modified spherical coordinates (MSC)

numBackSteps — Number of backward steps

positive integer

Number of backward steps, specified as a positive integer. The value must be less than or equal to the smaller of $F - 1$ and MB , where F is the number of executed forward steps and MB is the maximum number of backward steps specified by the `MaxNumSmoothingSteps` property of the filter.

Output Arguments

smoothX — Smoothed states

N-by-*K* matrix

Smoothed states, returned as an *N*-by-*K* matrix. *N* is the state dimension and *K* is the number of backward steps. The first column represents the earliest state in the time interval of smoothing, which is the end state of the backward recursion. The last column represents the latest state in the time interval of smoothing, which is the state at the beginning of backward recursion.

Data Types: `single` | `double`

smoothP — Smoothed covariances

N-by-*N*-by-*K* array

Smoothed covariances, returned as an *N*-by-*N*-by-*K* array. *N* is the state dimension and *K* is the number of backward steps. Each page (an *N*-by-*N* matrix) of the array is the smoothed covariance matrix for the corresponding smoothed state in the `smoothX` output.

Data Types: `single` | `double`

References

- [1] Särkkä, Simo. "Unscented Rauch--Tung--Striebel Smoother." *IEEE Transactions on Automatic Control*, 53, no. 3 (April 2008): 845-49. <https://doi.org/10.1109/TAC.2008.919531>.
- [2] Rauch, H. E., F. Tung, and C. T. Striebel. "Maximum Likelihood Estimates of Linear Dynamic Systems." *AIAA Journal* 3, no. 8 (August 1965): 1445-50. <https://doi.org/10.2514/3.3166>.

Extended Capabilities

C/C++ Code Generation

Generate C and C++ code using MATLAB® Coder™.

In code generation, after cloning the filter, you cannot change its `EnableSmoothing` property.

See Also

`smooth(for trackingIMM)`

Introduced in R2021a

sonarEmission

Emitted sonar signal structure

Description

The `sonarEmission` class creates a sonar emission object. This object contains all the properties that describe a signal radiated by a sonar source.

Creation

Syntax

```
signal = sonarEmission  
signal = sonarEmission(Name, Value)
```

Description

`signal = sonarEmission` creates a `sonarEmission` object with default properties. The object represents sonar signals from emitters, channels, and sensors.

`signal = sonarEmission(Name, Value)` sets object properties specified by one or more `Name, Value` pair arguments. `Name` can also be a property name and `Value` is the corresponding value. `Name` must appear inside single quotes (' '). You can specify several name-value pair arguments in any order as `Name1, Value1, ..., NameN, ValueN`.

Properties

PlatformID — Platform identifier

positive integer

Platform identifier, specified as a positive integer. The emitter is mounted on the platform with this ID. Each platform identifier is unique within a scenario.

Example: 5

Data Types: double

EmitterIndex — Emitter identifier

positive integer

Emitter identifier, specified as a positive integer. Each emitter index is unique.

Example: 2

Data Types: double

OriginPosition — Location of emitter

[0 0 0] (default) | 1-by-3 real-valued vector

Location of the emitter in scenario coordinates, specified as a 1-by-3 real-valued vector. Units are in meters.

Example: [100 -500 1000]

Data Types: double

OriginVelocity — Velocity of emitter

[0 0 0] (default) | 1-by-3 real-valued vector

Velocity of the emitter in scenario coordinates, specified as a 1-by-3 real-valued vector. Units are in meters per second.

Example: [0 -50 100]

Data Types: double

Orientation — Orientation of emitter

quaternion(1,0,0,0) (default) | quaternion | 3-by-3 real-valued orthogonal matrix

Orientation of the emitter in scenario coordinates, specified as a quaternion or 3-by-3 real-valued orthogonal matrix.

Example: eye(3)

Data Types: double

FieldOfView — Field of view of emitter

[180,180] | 2-by-1 vector of positive real values

Field of view of emitter, specified as a 2-by-1 vector of positive real values, [azfov, elfov]. The field of view defines the total angular extent of the signal emitted. The azimuth field of view azfov must lie in the interval (0,360]. The elevation field of view elfov must lie in the interval (0,180].

Example: [140;70]

Data Types: double

SourceLevel — Cumulative source level

0 (default) | scalar

Cumulative source level of an emitted signal, specified as a scalar. The cumulative source level of the emitted signal in decibels is relative to the intensity of a sound wave having an rms pressure of 1 micro-pascal. Units are in dB // 1 micro-pascal.

Example: 10

Data Types: double

TargetStrength — Cumulative target strength

0 (default) | scalar

Cumulative target strength of the source platform emitting the signal, specified as a scalar. Units are in dB.

Example: 10

Data Types: double

CenterFrequency — Center frequency of sonar signal

20e3 (default) | positive scalar

Center frequency of the signal, specified as a positive scalar. Units are in Hz.

Example: 10.5e3

Data Types: double

Bandwidth — Half-power bandwidth of sonar signal

2e3 (default) | positive scalar

Half-power bandwidth of the sonar signal, specified as a positive scalar. Units are in Hz.

Example: 1e3

Data Types: double

WaveformType — Waveform type identifier

0 (default) | nonnegative integer

Waveform type identifier, specified as a nonnegative integer.

Example: 5e3

Data Types: double

ProcessingGain — Processing gain

0 (default) | scalar

Processing gain associated with the signal waveform, specified as a scalar. Units are in dB.

Example: 10

Data Types: double

PropagationRange — Distance signal propagates

0 (default) | nonnegative scalar

Total distance over which the signal has propagated, specified as a nonnegative scalar. For direct-path signals, the range is zero. Units are in meters.

Example: 1000

Data Types: double

PropagationRangeRate — Range rate of signal propagation path

0 (default) | scalar

Total range rate for the path over which the signal has propagated, specified as a scalar. For direct-path signals, the range rate is zero. Units are in meters per second.

Example: 10

Data Types: double

Examples**Create Sonar Emission Object**

Create a sonarEmission object with specified properties.

```
signal = sonarEmission('PlatformID',6,'EmitterIndex',2, ...
    'OriginPosition',[100,3000,50],'TargetStrength',20, ...
    'CenterFrequency',20e3,'Bandwidth',500.0)
```

```
signal =
  sonarEmission with properties:

    PlatformID: 6
    EmitterIndex: 2
    OriginPosition: [100 3000 50]
    OriginVelocity: [0 0 0]
    Orientation: [1x1 quaternion]
    FieldOfView: [180 180]
    CenterFrequency: 20000
    Bandwidth: 500
    WaveformType: 0
    ProcessingGain: 0
    PropagationRange: 0
    PropagationRangeRate: 0
    SourceLevel: 0
    TargetStrength: 20
```

Detect Sonar Emission with Passive Sensor

Create a sonar emission and then detect the emission using a sonarSensor object.

First, create a sonar emission.

```
orient = quaternion([180 0 0],'eulerd','zyx','frame');
sonarSig = sonarEmission('PlatformID',1,'EmitterIndex',1, ...
    'OriginPosition',[30 0 0],'Orientation',orient, ...
    'SourceLevel',140,'TargetStrength',100);
```

Then create a passive sonar sensor.

```
sensor = sonarSensor(1,'No scanning');
```

Detect the sonar emission.

```
time = 0;
[dets, numDets, config] = sensor(sonarSig,time)
```

```
dets = 1x1 cell array
    {1x1 objectDetection}
```

```
numDets = 1
```

```
config = struct with fields:
    SensorIndex: 1
    IsValidTime: 1
    IsScanDone: 1
    FieldOfView: [1 5]
    MeasurementParameters: [1x1 struct]
```

Extended Capabilities

C/C++ Code Generation

Generate C and C++ code using MATLAB® Coder™.

See Also

`emissionsInBody` | `emissionsInBody` | `radarEmission` | `sonarEmitter` | `underwaterChannel`

Introduced in R2018b

theaterPlot

Plot objects, detections, and tracks in Scenario

Description

The `theaterPlot` object is used to display a plot of a `trackingScenario`. This type of plot can be used with sensors capable of detecting objects.

To display aspects of a scenario on a theater plot:

- 1 Create a `theaterPlot` object.
- 2 Create plotters for the aspects of the scenario that you want to plot.
- 3 Use the plotters with their corresponding plot functions to display those aspects on the theater plot.

This table shows the plotter functions to use based on the scenario aspect that you want to plot.

Scenario Aspect to Plot	Plotter Creation Function	Plotter Display Function
Sensor coverage areas	<code>coveragePlotter</code>	<code>plotCoverage</code>
Sensor detections	<code>detectionPlotter</code>	<code>plotDetection</code>
Object orientation	<code>orientationPlotter</code>	<code>plotOrientation</code>
Platform	<code>platformPlotter</code>	<code>plotPlatform</code>
Track	<code>trackPlotter</code>	<code>plotTrack</code>
Object trajectory	<code>trajectoryPlotter</code>	<code>plotTrajectory</code>

Creation

Syntax

```
tp = theaterPlot
tp = theaterPlot(Name, Value)
```

Description

`tp = theaterPlot` creates a theater plot in a new figure.

`tp = theaterPlot(Name, Value)` creates a theater plot in a new figure with optional input "Properties" on page 2-491 specified by one or more `Name, Value` pair arguments. Properties can be specified in any order as `Name1, Value1, . . . , NameN, ValueN`. Enclose each property name in quotes.

Properties

Parent — Parent axes

`theaterPlot` handle

Parent axes, specified as a theaterPlot handle. If you do not specify Parent, then theaterPlot creates axes in a new figure.

Plotters — Plotters created for theater plot

array of plotter objects

Plotters created for the theater plot, specified as an array of plotter objects.

XLimits — Limits of x-axis

two-element row vector

Limits of the x-axis, specified as a two-element row vector, [x1,x2]. The values x1 and x2 are the lower and upper limits, respectively, for the theater plot display. If you do not specify the limits, then the default values for the Parent property are used. See “Orientation, Position, and Coordinate” for coordinate system definitions.

Data Types: double

YLimits — Limits of y-axis

two-element row vector

Limits of the y-axis, specified as a two-element row vector, [y1,y2]. The values y1 and y2 are the lower and upper limits, respectively, for the theater plot display. If you do not specify the limits, then the default values for the Parent property are used. See “Orientation, Position, and Coordinate” for coordinate system definitions.

Data Types: double

ZLimits — Limits of z-axis

two-element row vector

Limits of the z-axis, specified as a two-element row vector, [z1,z2]. The values z1 and z2 are the lower and upper limits, respectively, for the theater plot display. If you do not specify the limits, then the default values for the Parent property are used. See “Orientation, Position, and Coordinate” for coordinate system definitions.

Data Types: double

AxesUnits — Unit of each axes

["m" "m" "m"] (default) | three-element string array

Unit of each axes, specified as a three-element string array. Each element must be "m" or "km"

Data Types: string

Object Functions**Plotter Creation**

coveragePlotter	Create coverage plotter
detectionPlotter	Create detection plotter
orientationPlotter	Create orientation plotter
platformPlotter	Create platform plotter
trackPlotter	Create track plotter
trajectoryPlotter	Create trajectory plotter

Plotter Display

plotCoverage	Plot set of coverages in theater coverage plotter
plotDetection	Plot set of detections in theater detection plotter
plotOrientation	Plot set of orientations in orientation plotter
plotPlatform	Plot set of platforms in platform plotter
plotTrack	Plot set of tracks in theater track plotter
plotTrajectory	Plot set of trajectories in trajectory plotter

Plotter Utilities

clearData	Clear data from specific plotter of theater plot
clearPlotterData	Clear plotter data from theater plot
findPlotter	Return array of plotters associated with theater plot

Examples

Create and Display Theater Plot

Create a theater plot.

```
tp = theaterPlot('XLim',[0 90], 'YLim',[-35 35], 'ZLim',[0 50]);
```

Display radar detections with coordinates at (30, - 5, 5), (50, - 10, 10), and (40, 7, 40). Set the view so that you are looking on the yz-plane. Confirm the y- and z-coordinates of the radar detections are correct.

```
radarPlotter = detectionPlotter(tp, 'DisplayName', 'Radar Detections');
plotDetection(radarPlotter, [30 -5 5; 50 -10 10; 40 7 40])
grid on
view(90,0)
```

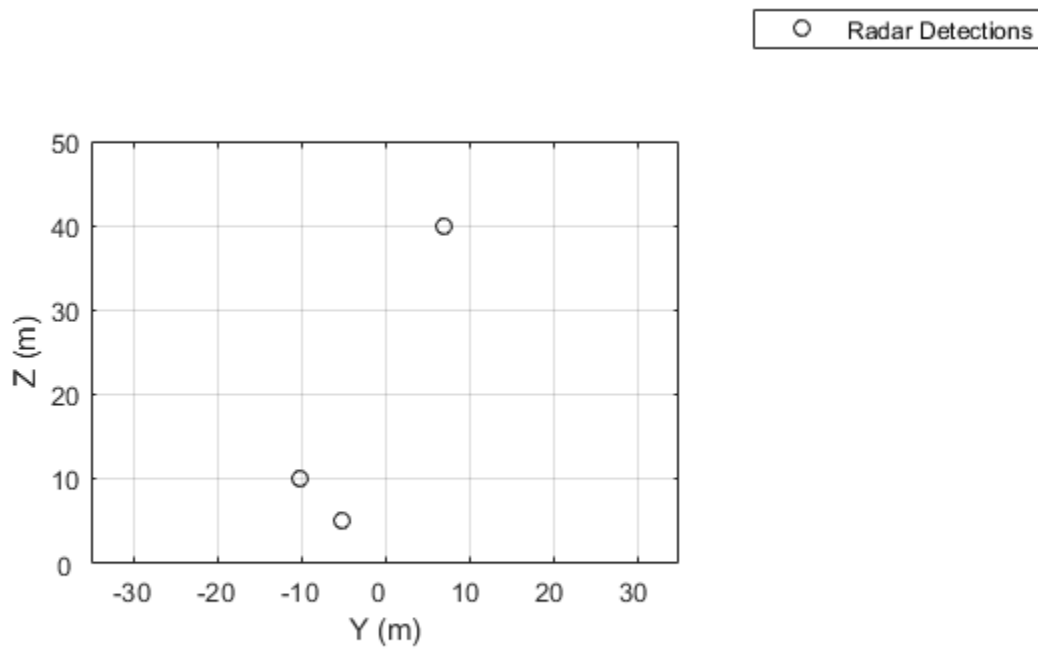

The view can be changed by opening the plot in a figure window and selecting **Tools > Rotate 3D** in the figure menu.

Limitations

You cannot use the rectangle-zoom feature in the `theaterPlot` figure.

See Also

`trackingScenario`

Introduced in R2018b

clearData

Clear data from specific plotter of theater plot

Syntax

```
clearData(pl)
```

Description

`clearData(pl)` clears data belonging to the plotter `pl` associated with a theater plot. This function clears data from plotters created by the following plotter methods:

- `detectionPlotter`
- `orientationPlotter`
- `platformPlotter`
- `trackPlotter`
- `trajectoryPlotter`

Examples

Clear Specific Plotter Data

Create a theater plot. Add a track plotter and detection plotter to the theater plot.

```
tp = theaterPlot('XLim',[0,90],'YLim',[-35,35]);  
tPlotter = trackPlotter(tp,'DisplayName','Tracks');  
radarPlotter = detectionPlotter(tp,'DisplayName','Radar Detections');
```

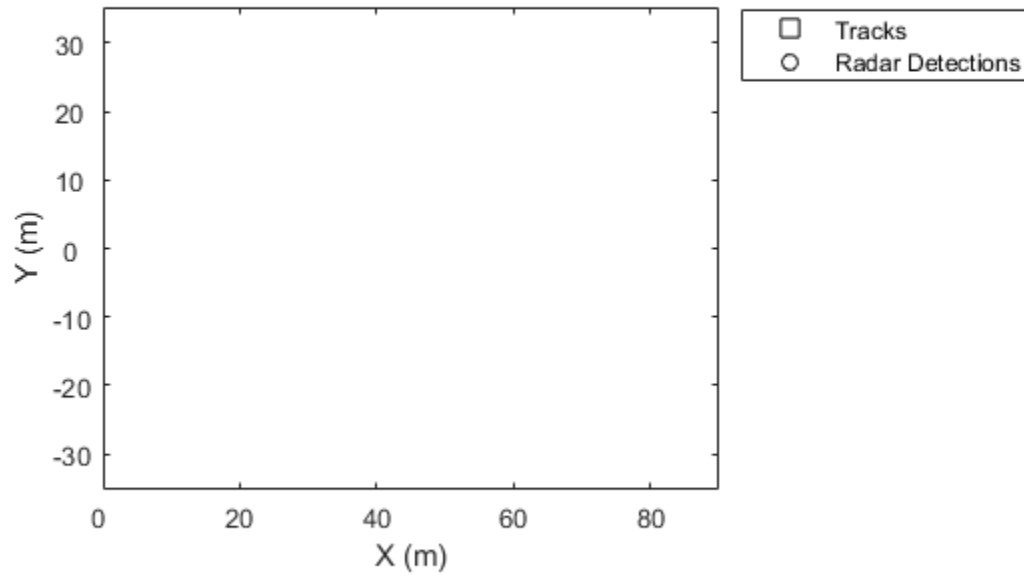

Plot a set of tracks in the track plotter.

```
trackPos = [30, 15, 1; 60, -15, 1; 20, 5, 1];  
trackLabels = {'T1', 'T2', 'T3'};  
plotTrack(tPlotter, trackPos, trackLabels)
```

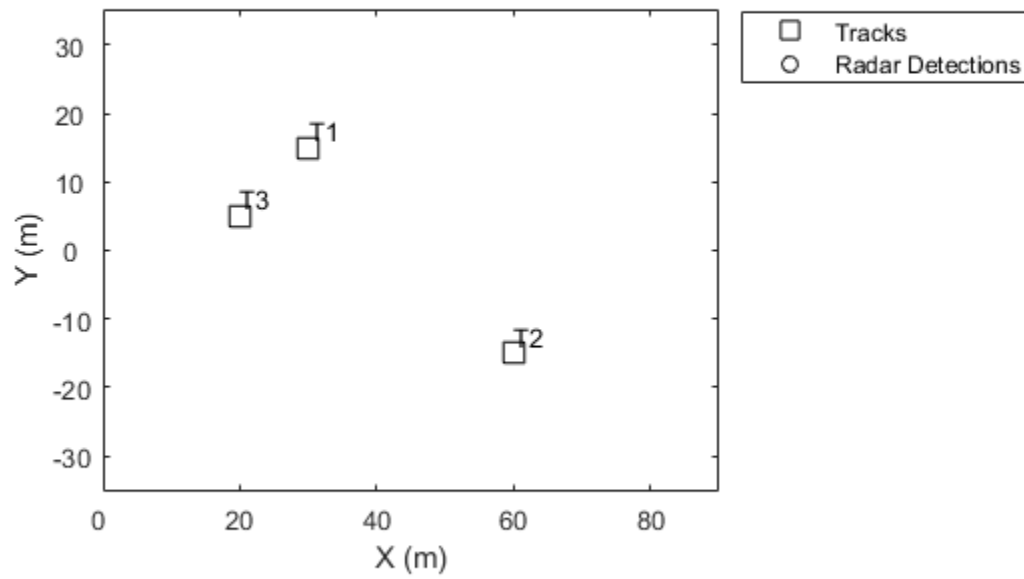

Plot a set of detections in the detection plotter.

```
detPos = [30, 5, 4; 30, -10, 2; 50, 15, 1];  
detLabels = {'R1', 'R2', 'R3'};  
plotDetection(radarPlotter, detPos, detLabels)
```

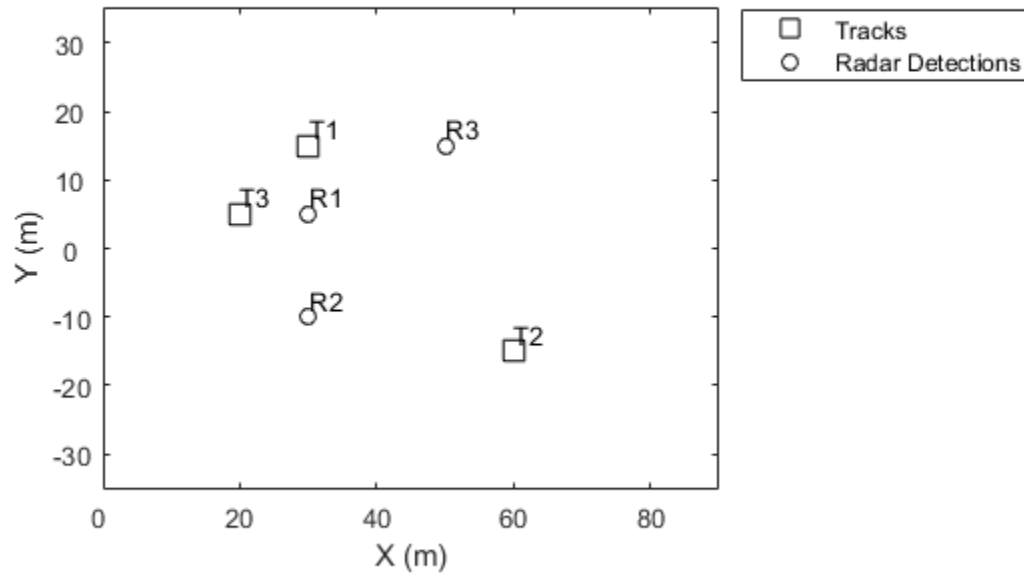

Delete the track plotter data.

```
clearData(tPlotter)
```

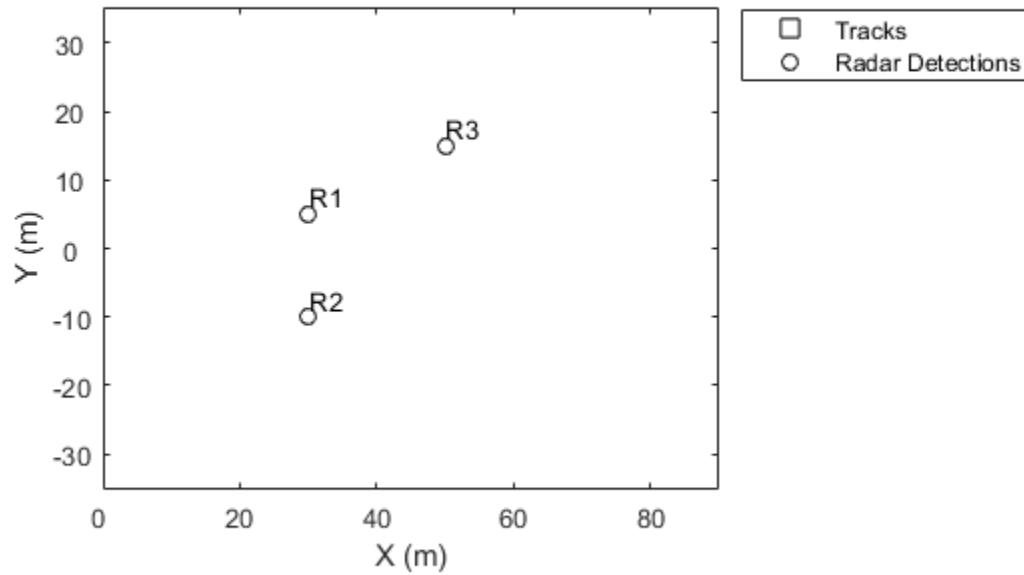

Input Arguments

p1 — Specific plotter belonging to theater plot
specific plotter of theater plot handle

Specific plotter belonging to a theater plot, specified as a plotter handle of theaterPlot.

See Also

[clearPlotterData](#) | [findPlotter](#) | [theaterPlot](#)

Introduced in R2018b

clearPlotterData

Clear plotter data from theater plot

Syntax

```
clearPlotterData(tp)
```

Description

`clearPlotterData(tp)` clears data shown in the plot from all the plotters used in the theater plot, `tp`. Legend entries and coverage areas are not cleared from the plot.

Examples

Clear Plotter Data from Theater Plot

Create a theater plot and a detection plotter.

```
tp = theaterPlot('XLim',[0, 90], 'YLim',[-35, 35], 'ZLim',[0, 10]);  
detectionPlotter(tp, 'DisplayName', 'Radar Detections');
```

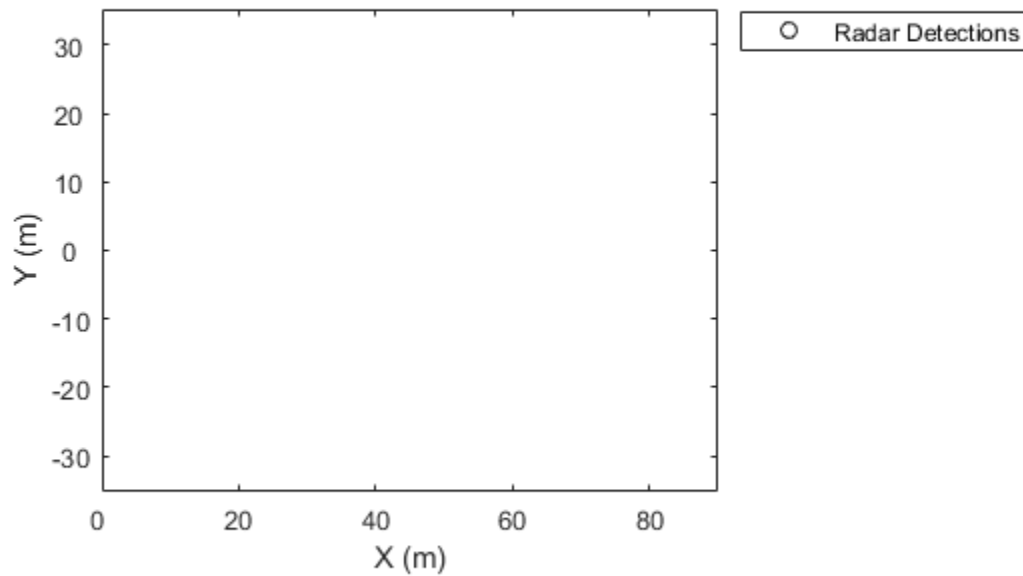

Use `findPlotter` to locate the plotter by its display name.

```
radarPlotter = findPlotter(tp, 'DisplayName', 'Radar Detections');
```

Plot three detections.

```
plotDetection(radarPlotter, [30, 5, 1; 30, -10, 2; 30, 15, 1]);
```

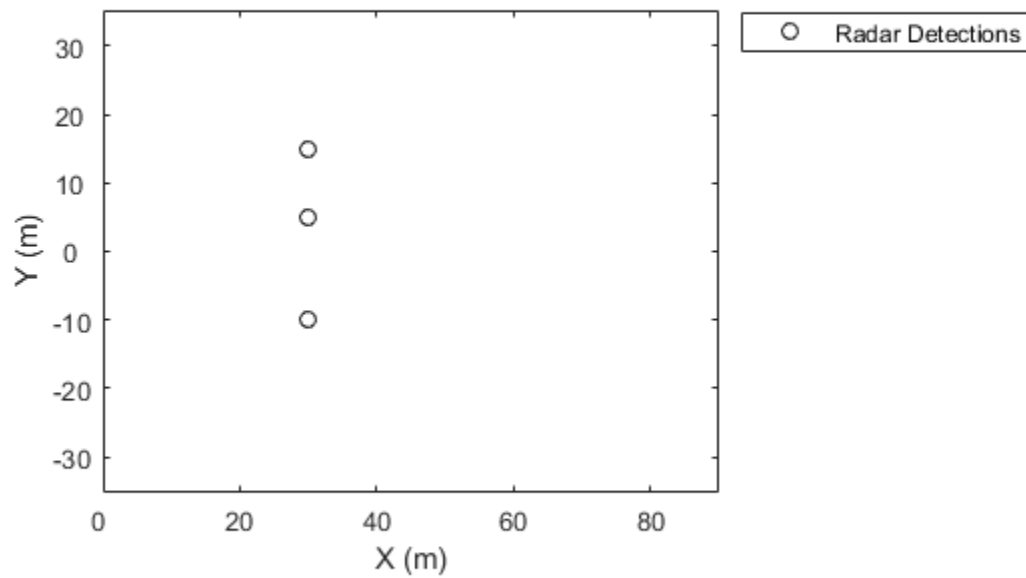

Clear data from the plot.

```
clearPlotterData(tp);
```

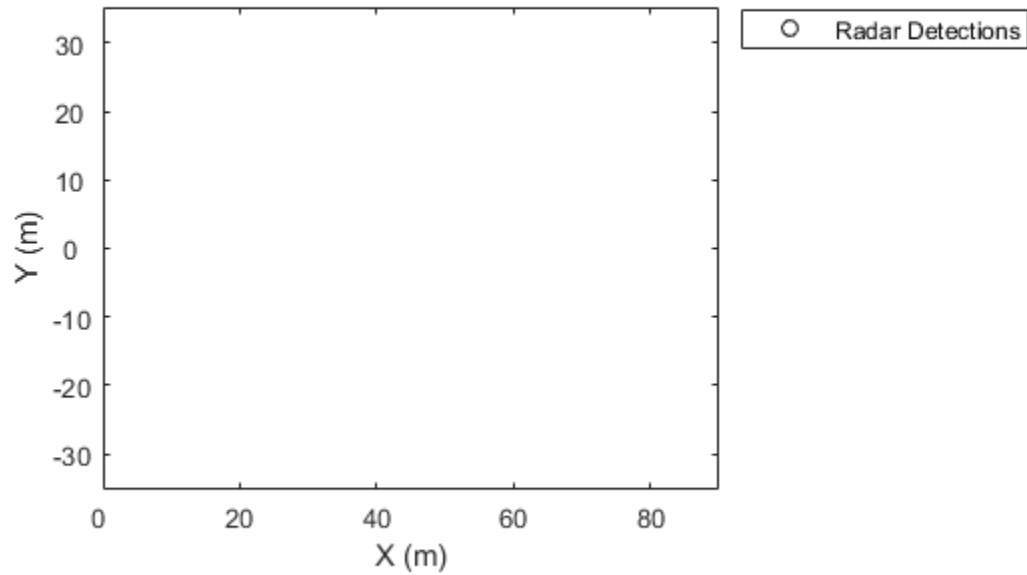

Input Arguments

tp — Theater plot
theaterPlot object

Theater plot, specified as a theaterPlot object.

See Also

[clearData](#) | [findPlotter](#) | [theaterPlot](#)

Introduced in R2018b

findPlotter

Return array of plotters associated with theater plot

Syntax

```
p = findPlotter(tp)
p = findPlotter(tp,Name,Value)
```

Description

`p = findPlotter(tp)` returns the array of plotters associated with the theater plot, `tp`.

Note In general, it is faster to use the plotters directly from the plotter creation methods of `theaterPlot`. Use `findPlotter` when it is otherwise inconvenient to use the plotter handles directly.

`p = findPlotter(tp,Name,Value)` specifies one or more `Name,Value` pair arguments required to match for the theater plot.

Examples

Find Plotter in Theater Plot

Create a theater plot and generate detection and platform plotters. Set the value of the `Tag` property of the detection plotter to `'radPlot'`.

```
tp = theaterPlot('XLim',[0, 90],'YLim',[-35, 35]);
detectionPlotter(tp,'DisplayName','Radar Detections','Tag','radPlot');
platformPlotter(tp,'DisplayName','Platforms');
```

Use `findPlotter` to locate the detection plotter based on its `Tag` property.

```
radarPlotter = findPlotter(tp,'Tag','radPlot')
```

```
radarPlotter =
  DetectionPlotter with properties:

    HistoryDepth: 0
      Marker: 'o'
    MarkerSize: 6
  MarkerEdgeColor: [0 0 0]
  MarkerFaceColor: 'none'
      FontSize: 10
    LabelOffset: [0 0 0]
  VelocityScaling: 1
          Tag: 'radPlot'
    DisplayName: 'Radar Detections'
```

Use the detection plotter to display the located objects.

```
plotDetection(radarPlotter, [30, 5, 0; 30, -20, 0; 30, 15, 0]);
```

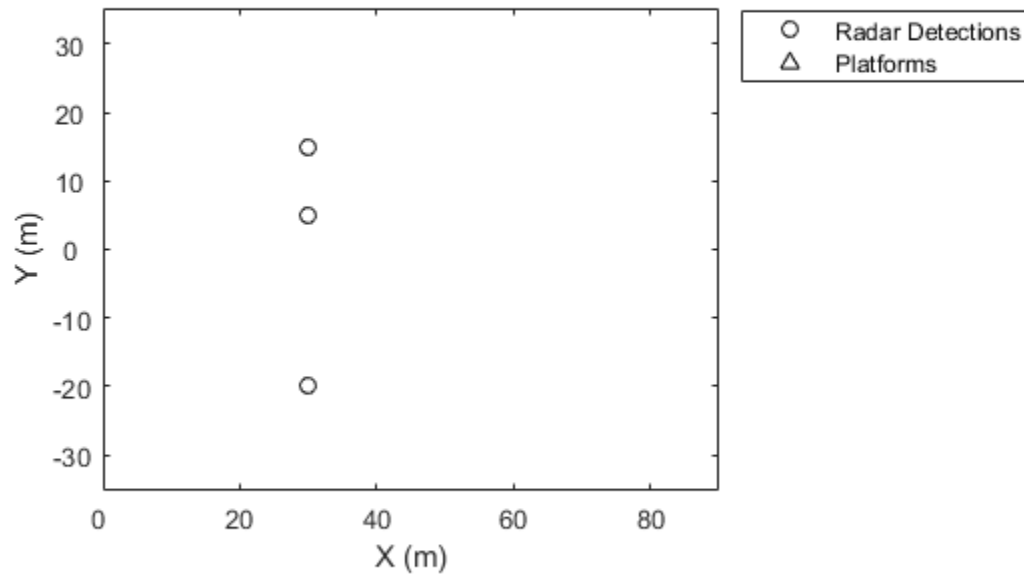

Input Arguments

tp — Theater plot

theaterPlot object

Theater plot, specified as a theaterPlot object.

Name-Value Pair Arguments

Specify optional comma-separated pairs of Name, Value arguments. Name is the argument name and Value is the corresponding value. Name must appear inside quotes. You can specify several name and value pair arguments in any order as Name1, Value1, ..., NameN, ValueN.

Example: 'Tag', 'thisPlotter'

DisplayName — Display name

character vector | string scalar

Display name of the plotter to find, specified as the comma-separated pair consisting of 'DisplayName' and a character vector or string scalar. DisplayName is the plotter name that appears in the legend. To match missing legend entries, specify DisplayName as ''.

Tag — Tag of plotter

character vector | string scalar

Tag of plotter to find, specified as the comma-separated pair consisting of 'Tag' a character vector or string scalar. By default, plotters have a Tag property with a default value of 'Plotter*N*', where *N* is an integer that corresponds to the *N*th plotter associated with the theater plot `tp`.

See Also

clearData | clearPlotterData | theaterPlot

Introduced in R2018b

coveragePlotter

Create coverage plotter

Syntax

```
cPlotter = coveragePlotter(tp)
cPlotter = coveragePlotter(tp,Name,Value)
```

Description

`cPlotter = coveragePlotter(tp)` creates a `CoveragePlotter` object for use with the theater plot object, `tp`. Use the `plotCoverage` function to plot the sensor coverage via the created `CoveragePlotter` object.

`cPlotter = coveragePlotter(tp,Name,Value)` creates a `CoveragePlotter` object with additional options specified by one or more `Name,Value` pair arguments.

Examples

Plot Coverage in Theater Plot

Create a theater plot and set the limits for its axes. Create a coverage plotter with `DisplayName` set to 'Sensor Coverage'.

```
tp = theaterPlot('XLim',[-40 40],'YLim',[-40 40],'ZLim',[-40 40]);
covp = coveragePlotter(tp,'DisplayName','Sensor Coverage');
```

Set up the configuration of the sensors whose coverage is to be plotted.

```
sensor = struct('Index',1,'ScanLimits',[-45 45],'FieldOfView',[10;40],...
    'LookAngle',-10,'Range',30,'Position',zeros(1,3),'Orientation',zeros(1,3));
```

Plot the coverage using the `plotCoverage` function and visualize the results. The dark blue represents the current sensor beam, and the light blue represents the coverage area.

```
plotCoverage(covp,sensor)
view(70,30)
```

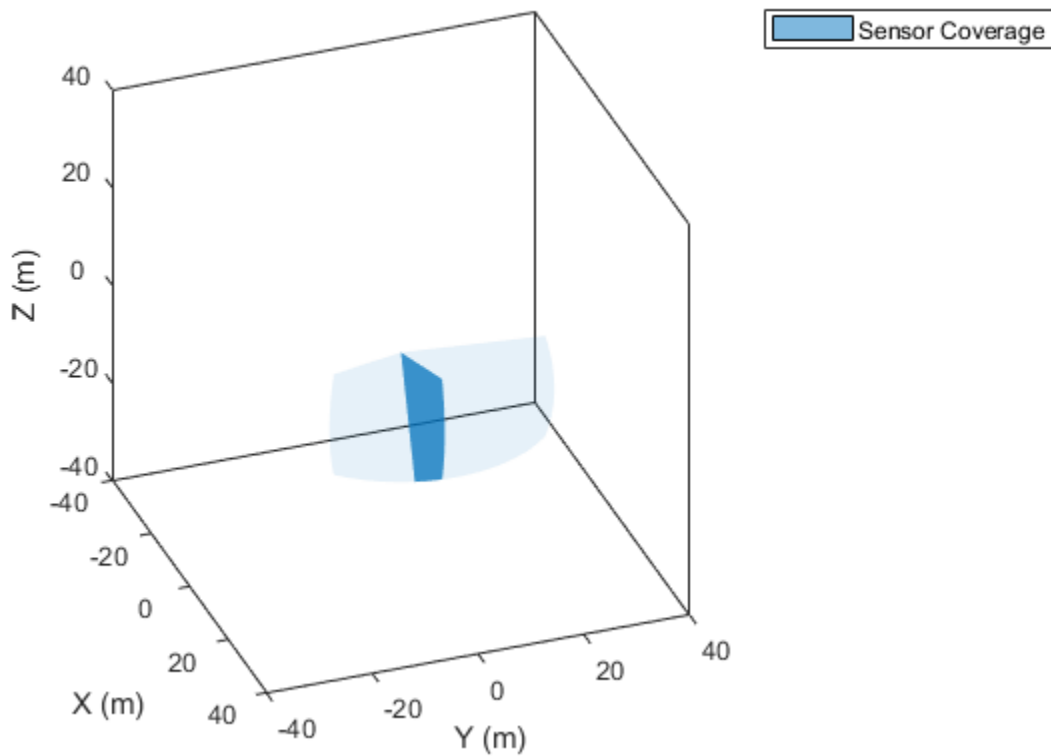

Animate Sensor Coverage Plot

Create a theater plot and create a coverage plotter.

```
tp = theaterPlot('XLim',[-1e7 1e7],'YLim',[-1e7 1e7],'ZLim',[-2e6 1e6]);
covp = coveragePlotter(tp,'DisplayName','Sensor Coverage');
view(25,20)
```

Model a non-scanning radar and a raster scanning radar.

```
radarIndex = 1;
radar =fusionRadarSensor(radarIndex,'No Scanning','RangeLimits',[0 1e8]);
RasterIndex = 2;
raster = fusionRadarSensor(RasterIndex,'Raster','RangeLimits',[0 1e8]);
```

Create a target platform.

```
tgt = struct( ...
    'PlatformID', 1, ...
    'Position', [0 -50e3 -1e3], ...
    'Speed', -1e3);
```

Simulate sensors and visualize their scanning pattern.

```
time = 0;
timestep = 1;
```

```

stopTime = 90;
while time < stopTime
    time = time+timestep;
    radar(tgt,time);
    raster(tgt,time);

    % Obtain sensor configuration using coverageConfig.
    radarcov = coverageConfig(radar);
    ircov = coverageConfig(raster);

    % Update plotter
    plotCoverage(covp,[radarcov,ircov],...
        [radarIndex, RasterIndex],...
        {'blue','red'}...
        );
    pause(0.03)
end

```

 Sensor Coverage

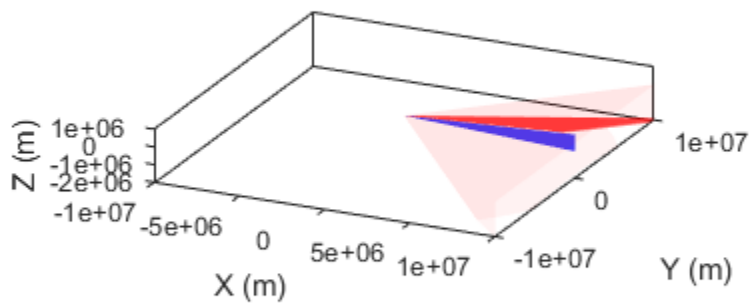

Input Arguments

tp — Theater plot
theaterPlot object

Theater plot, specified as a theaterPlot object.

Name-Value Pair Arguments

Specify optional comma-separated pairs of `Name`, `Value` arguments. `Name` is the argument name and `Value` is the corresponding value. `Name` must appear inside quotes. You can specify several name and value pair arguments in any order as `Name1, Value1, ..., NameN, ValueN`.

Example: `'DisplayName', 'Radar1'`

DisplayName — Plot name to display in legend

character vector | string scalar

Plot name to display in legend, specified as the comma-separated pair consisting of `'DisplayName'` and a character vector or string scalar. If no name is specified, no entry is shown.

Example: `'DisplayName', 'Radar Detections'`

Color — Coverage area and sensor beam color

'auto' (default) | character vector | string scalar | RGB triplet | hexadecimal color code

Coverage area and sensor beam color, specified as a character vector, a string scalar, an RGB triplet, a hexadecimal color code, or `'auto'`. When a color is specified, the plotter draws all coverage areas and beams with the specified color. If the color is set to `'auto'`, the plotter uses the axis color order to assign colors to sensors based on their sensor indices.

Alpha — Face alpha values of coverage area and sensor beam

[0.7 0.05] (default) | 2-element vector of nonnegative scalars

Face alpha values of the coverage area and the sensor beam, specified as a 2-element vector of nonnegative scalars. The first element is the value applied to the beam and the second element is the value applied to the coverage area.

Tag — Tag associated with plotter

'PlotterN' (default) | character vector | string

Tag associated with the plotter, specified as a character vector or string. You can use the `findPlotter` function to identify plotters based on their tag. The default value is `'PlotterN'`, where `N` is an integer that corresponds to the `N`th plotter associated with the `theaterPlot`.

Output Arguments

cPlotter — Coverage plotter

CoveragePlotter object

Coverage plotter, returned as a `CoveragePlotter` object. You can modify this object by changing its property values. The property names correspond to the name-value pair arguments of the `coveragePlotter` function.

To plot the coverage, use the `plotCoverage` function.

See Also

`clearData` | `clearPlotterData` | `plotCoverage` | `theaterPlot`

Introduced in R2020a

plotCoverage

Plot set of coverages in theater coverage plotter

Syntax

```
plotCoverage(cPlotter,configurations)
plotCoverage(cPlotter,configurations,indices,colors)
```

Description

`plotCoverage(cPlotter,configurations)` specifies configurations of M sensors or emitters whose coverage areas and beams are plotted by the `CoveragePlotter` object, `cPlotter`. See `coveragePlotter` on how to create a `CoveragePlotter` object.

`plotCoverage(cPlotter,configurations,indices,colors)` specifies the color of each coverage and beam plot pair using a list of indices and colors.

Examples

Plot Coverage in Theater Plot

Create a theater plot and set the limits for its axes. Create a coverage plotter with `DisplayName` set to 'Sensor Coverage'.

```
tp = theaterPlot('XLim',[-40 40],'YLim',[-40 40],'ZLim',[-40 40]);
covp = coveragePlotter(tp,'DisplayName','Sensor Coverage');
```

Set up the configuration of the sensors whose coverage is to be plotted.

```
sensor = struct('Index',1,'ScanLimits',[-45 45],'FieldOfView',[10;40],...
    'LookAngle',-10,'Range',30,'Position',zeros(1,3),'Orientation',zeros(1,3));
```

Plot the coverage using the `plotCoverage` function and visualize the results. The dark blue represents the current sensor beam, and the light blue represents the coverage area.

```
plotCoverage(covp,sensor)
view(70,30)
```

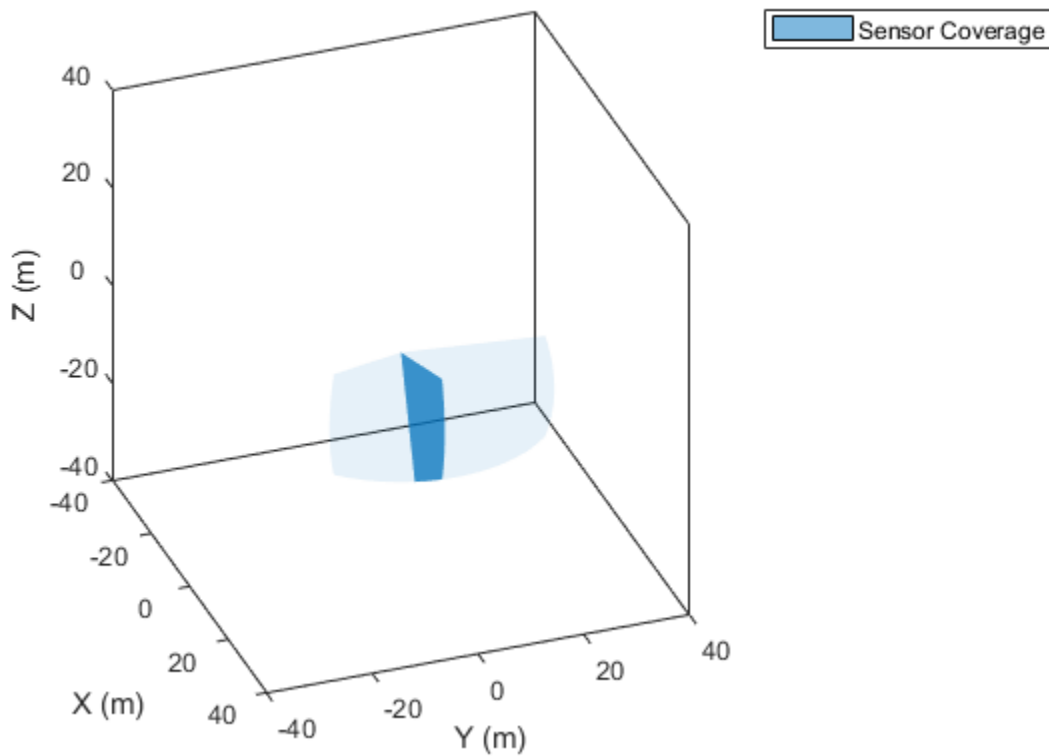
Animate Sensor Coverage Plot

Create a theater plot and create a coverage plotter.

```
tp = theaterPlot('XLim',[-1e7 1e7],'YLim',[-1e7 1e7],'ZLim',[-2e6 1e6]);
covp = coveragePlotter(tp,'DisplayName','Sensor Coverage');
view(25,20)
```

Model a non-scanning radar and a raster scanning radar.

```
radarIndex = 1;
radar =fusionRadarSensor(radarIndex,'No Scanning','RangeLimits',[0 1e8]);
RasterIndex = 2;
raster = fusionRadarSensor(RasterIndex,'Raster','RangeLimits',[0 1e8]);
```

Create a target platform.

```
tgt = struct( ...
    'PlatformID', 1, ...
    'Position', [0 -50e3 -1e3], ...
    'Speed', -1e3);
```

Simulate sensors and visualize their scanning pattern.

```
time = 0;
timestep = 1;
```

```

stopTime = 90;
while time < stopTime
    time = time+timestep;
    radar(tgt,time);
    raster(tgt,time);

    % Obtain sensor configuration using coverageConfig.
    radarcov = coverageConfig(radar);
    ircov = coverageConfig(raster);

    % Update plotter
    plotCoverage(covp,[radarcov,ircov],...
        [radarIndex, RasterIndex],...
        {'blue','red'}...
        );
    pause(0.03)
end

```

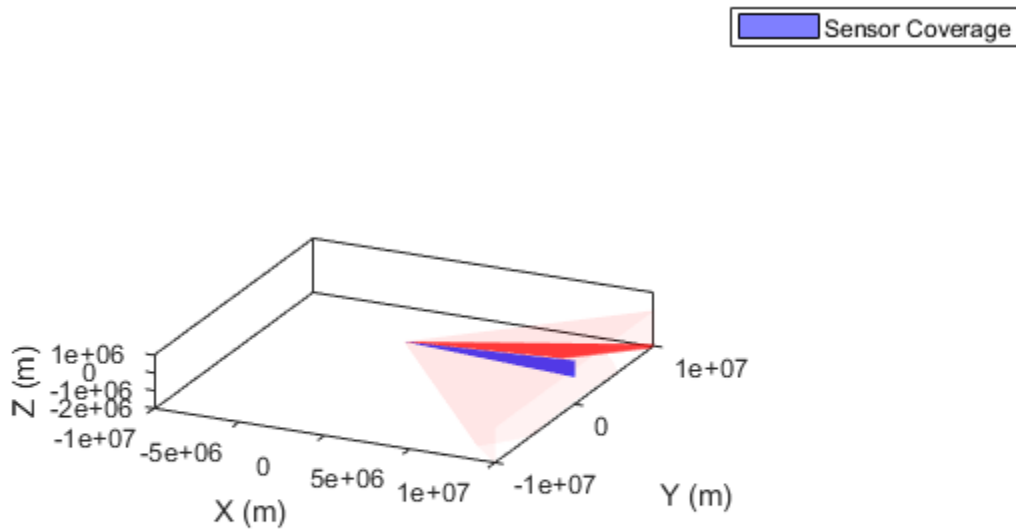

Input Arguments

cPlotter — Coverage plotter object

CoveragePlotter object

Coverage plotter object, created by the coveragePlotter function.

configurations — Sensor or emitter configurations

array of structures

Sensor or emitter configurations, specified as an array of structures. Each structure corresponds to the configuration of a sensor or emitter. The fields of each structure are:

Fields of configurations

Field	Description
Index	A unique integer to distinguish sensors or emitters.
LookAngle	The current boresight angles of the sensor or emitter, specified as: <ul style="list-style-type: none"> • A scalar in degrees if scanning only in the azimuth direction. • A two-element vector [azimuth; elevation] in degrees if scanning both in the azimuth and elevation directions.
FieldOfView	The field of view of the sensor or emitter, specified as a two-element vector [azimuth; elevation] in degrees.
ScanLimits	The minimum and maximum angles the sensor or emitter can scan from its Orientation. <ul style="list-style-type: none"> • If the sensor or emitter can only scan in the azimuth direction, specify the limits as a 1-by-2 row vector [minAz, maxAz] in degrees. • If the sensor or emitter can also scan in the elevation direction, specify the limits as a 2-by-2 matrix [minAz, maxAz; minEl, maxEl] in degrees.
Range	The range of the beam and coverage area of the sensor or emitter in meters.
Position	The origin position of the sensor or emitter, specified as a three-element vector [X, Y, Z] on the theater plot's axes.
Orientation	The rotation transformation from the scenario or global frame to the sensor or emitter mounting frame, specified as a rotation matrix, a quaternion, or three Euler angles in ZYX sequence.

Tip If either the value of Position field or the value of the Orientation field is NaN, the corresponding coverage area and beam will not be plotted.

indices — Sensor or emitter indices*N*-element array of nonnegative integers

Sensor or emitter indices, specified as an N -element array of nonnegative integers. This argument allows you to specify the color of each coverage area and beam pair with the corresponding index.

Example: [1;2;4]

colors – Coverage plotter colors

N -element array of character vector | N -element array of string scalar | N -element array of RGB triplet | N -element array of hexadecimal color code

Coverage plotter colors, specified as an N -element vector of character vectors, string scalars, RGB triplets, or hexadecimal color codes. N is the number of elements in the `indices` array. The coverage area and beam pair indexed by the i th element in the `indices` array is plotted with the color specified by the i th element of the `colors` array.

See Also

`clearData` | `clearPlotterData` | `coveragePlotter` | `theaterPlot`

Introduced in R2020a

detectionPlotter

Create detection plotter

Syntax

```
detPlotter = detectionPlotter(tp)
detPlotter = detectionPlotter(tp,Name,Value)
```

Description

`detPlotter = detectionPlotter(tp)` creates a detection plotter for use with the theater plot `tp`.

`detPlotter = detectionPlotter(tp,Name,Value)` creates a detection plotter with additional options specified by one or more `Name, Value` pair arguments.

Examples

Create and Update Detections for Theater Plot

Create a theater plot.

```
tp = theaterPlot('XLim',[0,90],'YLim',[-35,35],'ZLim',[1,10]);
```

Create a detection plotter with the name Radar Detections.

```
radarPlotter = detectionPlotter(tp,'DisplayName','Radar Detections');
```

Update the detection plotter with three detections labeled 'R1', 'R2', and 'R3' positioned in units of meters at (30, 5, 4), (30, -10, 2), and (30, 15, 1) with corresponding velocities (in m/s) of (-10, 0, 2), (-10, 3, 1), and (-10, -4, 1), respectively.

```
positions = [30, 5, 4; 30, -10, 2; 30, 15, 1];
velocities = [-10, 0, 2; -10, 3, 1; -10, -4, 1];
labels = {'R1','R2','R3'};
plotDetection(radarPlotter, positions, velocities, labels)
```

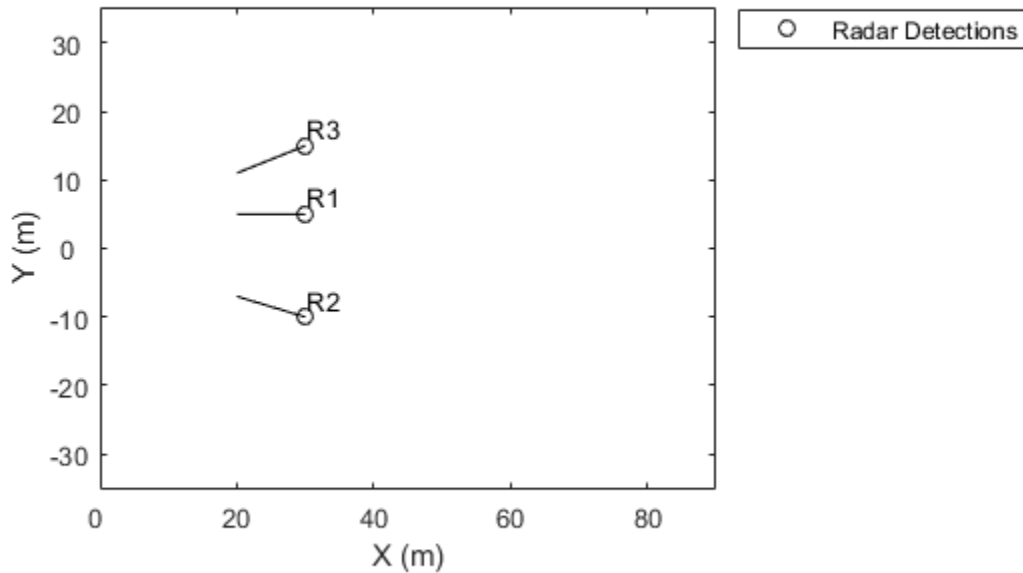

Input Arguments

tp – Theater plot

theaterPlot object

Theater plot, specified as a theaterPlot object.

Name-Value Pair Arguments

Specify optional comma-separated pairs of **Name**, **Value** arguments. **Name** is the argument name and **Value** is the corresponding value. **Name** must appear inside quotes. You can specify several name and value pair arguments in any order as **Name1**, **Value1**, ..., **NameN**, **ValueN**.

Example: 'MarkerSize', 10

DisplayName – Plot name to display in legend

character vector | string scalar

Plot name to display in legend, specified as the comma-separated pair consisting of 'DisplayName' and a character vector or string scalar. If no name is specified, no entry is shown.

Example: 'DisplayName', 'Radar Detections'

HistoryDepth – Number of previous updates to display

0 (default) | nonnegative integer less than or equal to 10,000

Number of previous track updates to display, specified as the comma-separated pair consisting of 'HistoryDepth' and a nonnegative integer less than or equal to 10,000. If set to 0, then no previous updates are rendered.

Marker — Marker symbol

'o' (default) | character vector | string scalar

Marker symbol, specified as the comma-separated pair consisting of 'Marker' and one of these symbols.

Value	Description
'o'	Circle
'+'	Plus sign
'*'	Asterisk
'.'	Point
'x'	Cross
'_'	Horizontal line
' '	Vertical line
'square' or 's'	Square
'diamond' or 'd'	Diamond
'^'	Upward-pointing triangle
'v'	Downward-pointing triangle
'>'	Right-pointing triangle
'<'	Left-pointing triangle
'pentagram' or 'p'	Five-pointed star (pentagram)
'hexagram' or 'h'	Six-pointed star (hexagram)
'none'	No markers

MarkerSize — Size of marker

6 (default) | positive integer

Size of marker, specified as the comma-separated pair consisting of 'MarkerSize' and a positive integer in points.

MarkerEdgeColor — Marker outline color

'black' (default) | character vector | string scalar | RGB triplet | hexadecimal color code

Marker outline color, specified as the comma-separated pair consisting of 'MarkerEdgeColor' and a character vector, a string scalar, an RGB triplet, or a hexadecimal color code.

MarkerFaceColor — Marker fill color

'none' (default) | character vector | string scalar | RGB triplet | hexadecimal color code

Marker outline color, specified as the comma-separated pair consisting of 'MarkerFaceColor' and a character vector, a string scalar, an RGB triplet, a hexadecimal color code, or 'none'. The default is 'none'.

FontSize — Font size for labeling platforms

10 (default) | positive integer

Font size for labeling detections, specified as the comma-separated pair consisting of 'FontSize' and a positive integer that represents font point size.

LabelOffset — Gap between label and positional point

[0 0 0] (default) | three-element row vector

Gap between label and positional point it annotates, specified as the comma-separated pair consisting of 'LabelOffset' and a three-element row vector. Specify the [x y z] offset in meters.

VelocityScaling — Scale factor for magnitude length of velocity vectors

1 (default) | positive scalar

Scale factor for magnitude length of velocity vectors, specified as the comma-separated pair consisting of 'VelocityScaling' and a positive scalar. The plot renders the magnitude vector value as VK , where V is the magnitude of the velocity in meters per second, and K is the value of VelocityScaling.

Tag — Tag to associate with the plotter

'PlotterN' (default) | character vector | string scalar

Tag to associate with the plotter, specified as the comma-separated pair consisting of 'Tag' and a character vector or string scalar. The default value is 'PlotterN', where N is an integer that corresponds to the N th plotter associated with the theaterPlot.

Tags provide a way to identify plotter objects, for example when searching using findPlotter.

See Also

clearData | clearPlotterData | plotDetection | theaterPlot

Introduced in R2018b

plotDetection

Plot set of detections in theater detection plotter

Syntax

```
plotDetection(detPlotter,positions)
plotDetection(detPlotter,positions,velocities)
plotDetection(detPlotter,positions,___,labels)
plotDetection(detPlotter,positions,___,covariances)
```

Description

`plotDetection(detPlotter,positions)` specifies positions of M detected objects whose positions are plotted by the detection plotter `detPlotter`. Specify the positions as an M -by-3 matrix, where each column of the matrix corresponds to the x -, y -, and z -coordinates of the detected object locations.

`plotDetection(detPlotter,positions,velocities)` also specifies the corresponding velocities of the detections. Velocities are plotted as line vectors emanating from the center positions of the detections. If specified, `velocities` must have the same dimensions as `positions`.

`plotDetection(detPlotter,positions,___,labels)` also specifies a cell vector of length M whose elements contain the text labels corresponding to the M detections specified in the positions matrix. If omitted, no labels are plotted.

`plotDetection(detPlotter,positions,___,covariances)` also specifies the covariances of the M detection uncertainties, where the covariances are a 3-by-3-by- M matrix of covariances that are centered at the positions of each detection. The uncertainties are plotted as an ellipsoid

Examples

Create and Update Detections for Theater Plot

Create a theater plot.

```
tp = theaterPlot('XLim',[0,90],'YLim',[-35,35],'ZLim',[1,10]);
```

Create a detection plotter with the name Radar Detections.

```
radarPlotter = detectionPlotter(tp,'DisplayName','Radar Detections');
```

Update the detection plotter with three detections labeled 'R1', 'R2', and 'R3' positioned in units of meters at (30, 5, 4), (30, -10, 2), and (30, 15, 1) with corresponding velocities (in m/s) of (-10, 0, 2), (-10, 3, 1), and (-10, -4, 1), respectively.

```
positions = [30, 5, 4; 30, -10, 2; 30, 15, 1];
velocities = [-10, 0, 2; -10, 3, 1; -10, -4, 1];
labels = {'R1','R2','R3'};
plotDetection(radarPlotter, positions, velocities, labels)
```

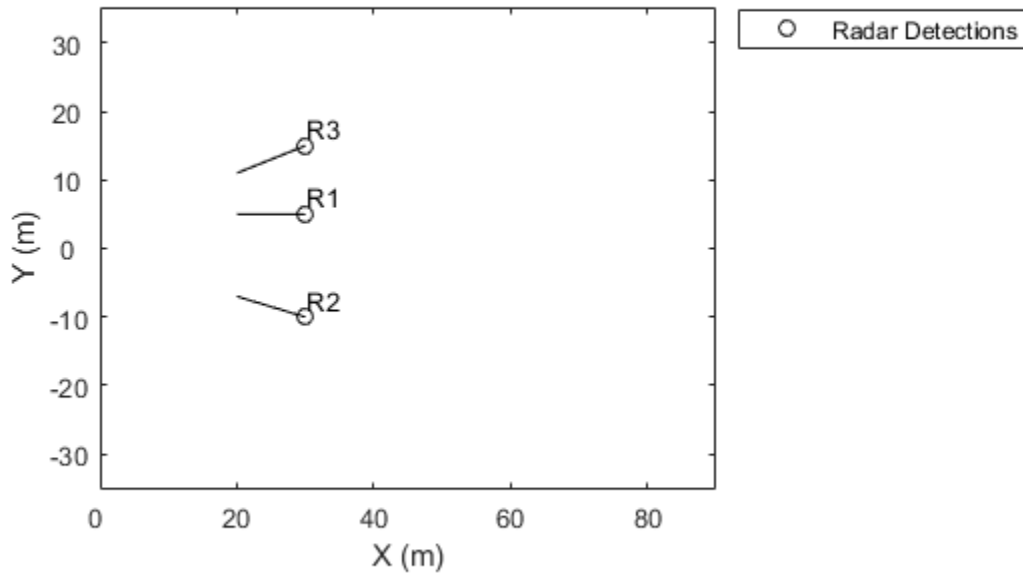

Input Arguments

detPlotter — Detection plotter

detectionPlotter object

Detection plotter, specified as a detectionPlotter object.

positions — Detection positions

real-valued matrix

Detection positions, specified as an M -by-3 real-valued matrix, where M is the number of detections. Each column of the matrix corresponds to the x -, y -, and z -coordinates of the detection positions in meters.

velocities — Detection velocities

real-valued matrix

Detection velocities, specified as an M -by-3 real-valued matrix, where M is the number of detections. Each column of the matrix corresponds to the x -, y -, and z -velocities of the detections. If specified, **velocities** must have the same dimensions as **positions**.

labels — Detection labels

cell array

Detection labels, specified as a M -by-1 cell array of character vectors, where M is the number of detections. The input argument `labels` contains the text labels corresponding to the M detections specified in `positions`. If `labels` is omitted, no labels are plotted.

covariances – Detection uncertainties

real-valued array

Detection uncertainties of M tracked objects, specified as a 3-by-3-by- M real-valued array of covariances. The covariances are centered at the positions of each detection and are plotted as an ellipsoid.

See Also

`clearData` | `clearPlotterData` | `detectionPlotter` | `theaterPlot`

Introduced in R2018b

orientationPlotter

Create orientation plotter

Syntax

```
oPlotter = orientationPlotter(tp)
oPlotter = orientationPlotter(tp,Name,Value)
```

Description

`oPlotter = orientationPlotter(tp)` creates an orientation plotter for use with the theater plot `tp`.

`oPlotter = orientationPlotter(tp,Name,Value)` creates an orientation plotter with additional options specified by one or more `Name,Value` pair arguments.

Examples

Show Orientation of Oscillating Device

This example shows how to animate the orientation of an oscillating device.

Load `rpy_9axis.mat`. The data in `rpy_9axis.mat` is recorded accelerometer, gyroscope, and magnetometer sensor data from a device oscillating in pitch (around *y*-axis), then yaw (around *z*-axis), then roll (around *x*-axis). The device's *x*-axis was pointing southward when recorded.

```
ld = load('rpy_9axis.mat')

ld = struct with fields:
    Fs: 200
    sensorData: [1x1 struct]
```

Set the sampling frequency. Extract the accelerometer and gyroscope data. Set the decimation factor to 2. Use `fuse` to create an indirect Kalman sensor fusion filter from the data.

```
accel = ld.sensorData.Acceleration;
gyro = ld.sensorData.AngularVelocity;
Fs = ld.Fs;
decim = 2;
fuse = imufilter('SampleRate',Fs,'DecimationFactor',decim);
```

Obtain the pose information of the fused data.

```
pose = fuse(accel,gyro);
```

Create a theater plot. Add to the theater plot an orientation plotter with `'DisplayName'` set to `'Fused Data'` and `'LocalAxesLength'` set to 2.

```
tp = theaterPlot('XLimit',[-2 2],'YLimit',[-2 2],'ZLimit',[-2 2]);
op = orientationPlotter(tp,'DisplayName','Fused Data',...
    'LocalAxesLength',2);
```

Loop through the pose information to animate the changing orientation.

```
for i=1:numel(pose)
    plotOrientation(op, pose(i))
    drawnow
end
```

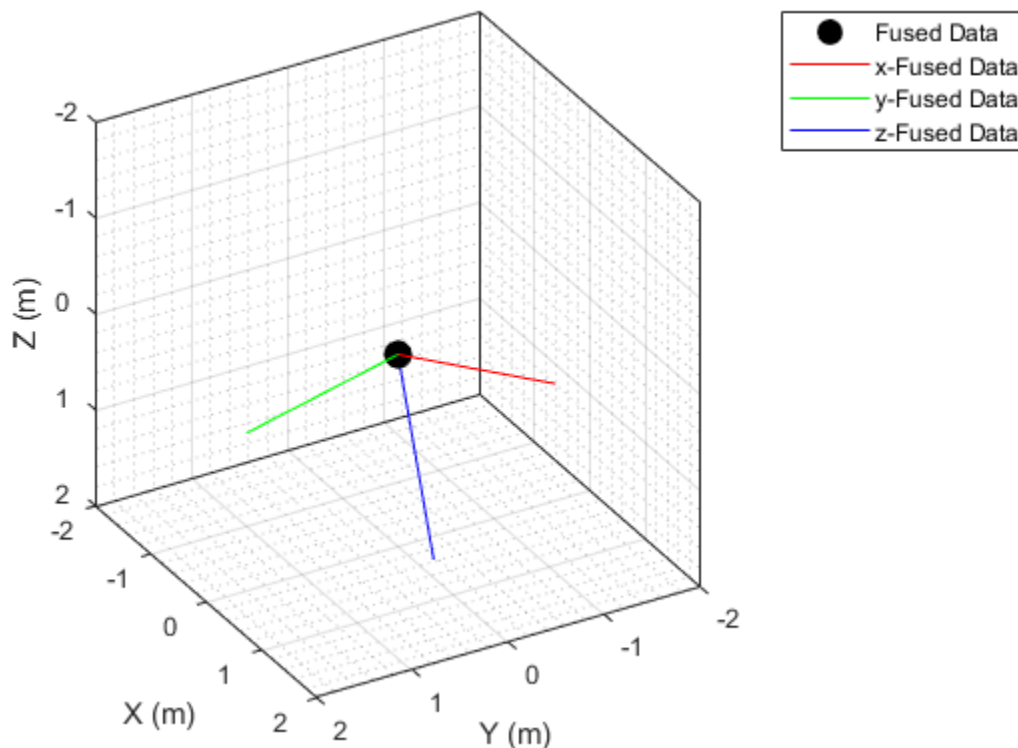

Input Arguments

tp — Theater plot
theaterPlot object

Theater plot, specified as a theaterPlot object.

Name-Value Pair Arguments

Specify optional comma-separated pairs of Name, Value arguments. Name is the argument name and Value is the corresponding value. Name must appear inside quotes. You can specify several name and value pair arguments in any order as Name1, Value1, ..., NameN, ValueN.

Example: 'HistoryDepth',6

DisplayName — Plot name to display in legend

character vector | string scalar

Plot name to display in legend, specified as the comma-separated pair consisting of 'DisplayName' and a character vector or string scalar. If no name is specified, no entry is shown.

Example: 'DisplayName', 'Radar Detections'

HistoryDepth — Number of previous track updates to display

0 (default) | nonnegative integer less than or equal to 100

Number of previous track updates to display, specified as the comma-separated pair consisting of 'HistoryDepth' and a nonnegative integer less than or equal to 100. If set to 0, then no previous updates are rendered.

Marker — Marker symbol

'o' (default) | character vector | string scalar

Marker symbol, specified as the comma-separated pair consisting of 'Marker' and one of these symbols.

Value	Description
'o'	Circle
'+'	Plus sign
'*'	Asterisk
'.'	Point
'x'	Cross
'_'	Horizontal line
' '	Vertical line
'square' or 's'	Square
'diamond' or 'd'	Diamond
'^'	Upward-pointing triangle
'v'	Downward-pointing triangle
'>'	Right-pointing triangle
'<'	Left-pointing triangle
'pentagram' or 'p'	Five-pointed star (pentagram)
'hexagram' or 'h'	Six-pointed star (hexagram)
'none'	No markers

MarkerSize — Size of marker

10 (default) | positive integer

Size of marker, specified in points as the comma-separated pair consisting of 'MarkerSize' and a positive integer.

MarkerEdgeColor — Marker outline color

'black' (default) | character vector | string scalar | RGB triplet | hexadecimal color code

Marker outline color, specified as the comma-separated pair consisting of 'MarkerEdgeColor' and a character vector, string scalar, an RGB triplet, or a hexadecimal color code. The default color is 'black'.

MarkerFaceColor — Marker fill color

'none' (default) | character vector | string scalar | RGB triplet | hexadecimal color code

Marker outline color, specified as the comma-separated pair consisting of 'MarkerFaceColor' and a character vector, a string scalar, an RGB triplet, a hexadecimal color code, or 'none'. The default is 'none'.

FontSize — Font size for labeling tracks

10 (default) | positive integer

Font size for labeling tracks, specified as the comma-separated pair consisting of 'FontSize' and a positive integer that represents font point size.

LabelOffset — Gap between label and positional point

[0 0 0] (default) | three-element row vector

Gap between label and positional point it annotates, specified as the comma-separated pair consisting of 'LabelOffset' and a three-element row vector. Specify the [x y z] offset in meters.

LocalAxesLength — Length of line

1 (default) | positive scalar

Length of line used to denote each of the local x-, y-, and z-axes of the given orientation, specified as the comma-separated pair consisting of 'LocalAxesLength' and a positive scalar. 'LocalAxesLength' is in meters.

Tag — Tag to associate with the plotter

'PlotterN' (default) | character vector | string scalar

Tag to associate with the plotter, specified as the comma-separated pair consisting of 'Tag' and a character vector or string scalar. The default value is 'PlotterN', where N is an integer that corresponds to the Nth plotter associated with the theaterPlot.

Tags provide a way to identify plotter objects, for example when searching using findPlotter.

See Also

clearData | clearPlotterData | plotOrientation | theaterPlot

Introduced in R2018b

plotOrientation

Plot set of orientations in orientation plotter

Syntax

```
plotOrientation(oPlotter,orientations)
plotOrientation(oPlotter,roll,pitch,yaw)
plotOrientation(oPlotter, __ ,positions)
plotOrientation(oPlotter, __ ,positions,labels)
```

Description

`plotOrientation(oPlotter,orientations)` specifies the orientations of M objects to show for the orientation plotter, `oPlotter`. The `orientations` argument can be either an M -by-1 array of quaternions, or a 3-by-3-by- M array of rotation matrices.

`plotOrientation(oPlotter,roll,pitch,yaw)` specifies the orientations of M objects to show for the orientation plotter, `oPlotter`. The arguments `roll`, `pitch`, and `yaw` are M -by-1 vectors measured in degrees.

`plotOrientation(oPlotter, __ ,positions)` also specifies the positions of the objects as an M -by-3 matrix. Each column of `positions` corresponds to the x -, y -, and z -coordinates of the object locations, respectively.

`plotOrientation(oPlotter, __ ,positions,labels)` also specifies the labels as an M -by-1 cell array of character vectors that correspond to the M orientations.

Examples

Show Orientation of Oscillating Device

This example shows how to animate the orientation of an oscillating device.

Load `rpy_9axis.mat`. The data in `rpy_9axis.mat` is recorded accelerometer, gyroscope, and magnetometer sensor data from a device oscillating in pitch (around y -axis), then yaw (around z -axis), then roll (around x -axis). The device's x -axis was pointing southward when recorded.

```
ld = load('rpy_9axis.mat')
ld = struct with fields:
    Fs: 200
    sensorData: [1x1 struct]
```

Set the sampling frequency. Extract the accelerometer and gyroscope data. Set the decimation factor to 2. Use `fuse` to create an indirect Kalman sensor fusion filter from the data.

```
accel = ld.sensorData.Acceleration;
gyro = ld.sensorData.AngularVelocity;
Fs = ld.Fs;
```



```
decim = 2;
fuse = imufilter('SampleRate',Fs,'DecimationFactor',decim);
```

Obtain the pose information of the fused data.

```
pose = fuse(accel,gyro);
```

Create a theater plot. Add to the theater plot an orientation plotter with 'DisplayName' set to 'Fused Data' and 'LocalAxesLength' set to 2.

```
tp = theaterPlot('XLimit',[-2 2],'YLimit',[-2 2],'ZLimit',[-2 2]);
op = orientationPlotter(tp,'DisplayName','Fused Data',...
    'LocalAxesLength',2);
```

Loop through the pose information to animate the changing orientation.

```
for i=1:numel(pose)
    plotOrientation(op, pose(i))
    drawnow
end
```

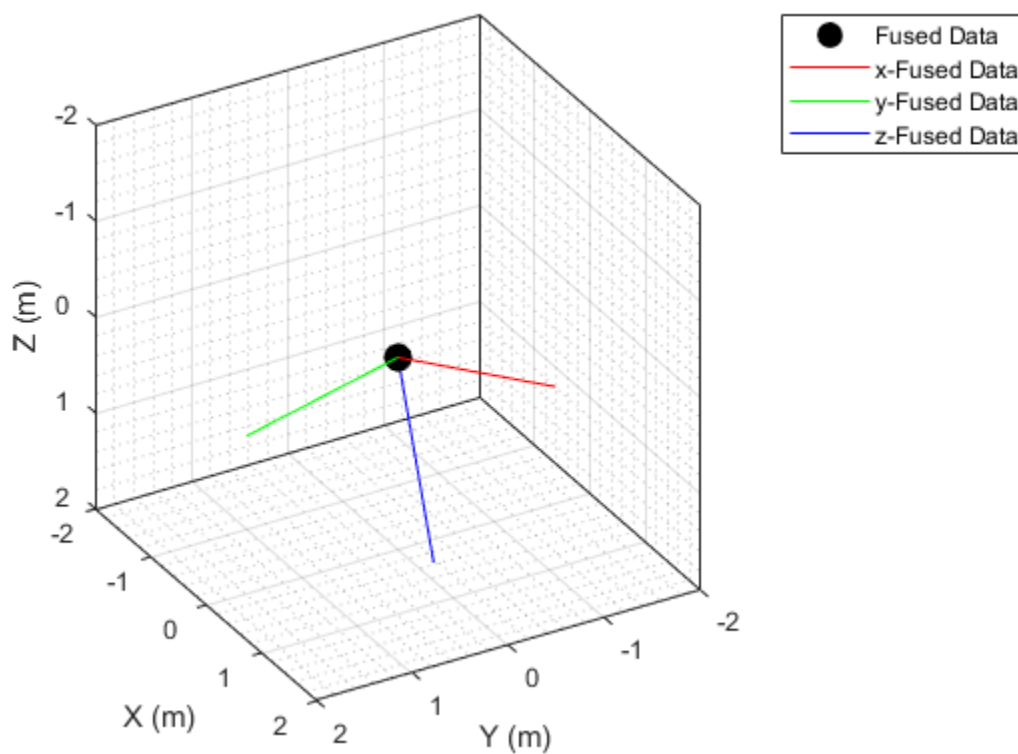

Input Arguments

oPlotter — Orientation plotter

orientationPlotter object

Orientation plotter, specified as an orientationPlotter object.

orientations — Orientations

quaternion array | real-valued array

Orientations of M objects, specified as either an M -by-1 array of quaternions, or a 3-by-3-by- M array of rotation matrices.

roll, pitch, yaw — Roll, pitch, yaw

real-valued vectors

Roll, pitch, and yaw angles defining the orientations of M objects, specified as M -by-1 vectors. Angles are measured in degrees.

positions — Object positions $[0\ 0\ 0]$ (default) | real-valued matrix

Object positions, specified as an M -by-3 real-valued matrix, where M is the number of objects. Each column of the matrix corresponds to the x -, y -, and z -coordinates of the objects locations in meters. The default value of `positions` is at the origin.

labels — Object labels

cell array

Object labels, specified as a M -by-1 cell array of character vectors, where M is the number of objects. `labels` contains the text labels corresponding to the M objects specified in `positions`. If `labels` is omitted, no labels are plotted.

See Also

clearData | clearPlotterData | orientationPlotter | theaterPlot

Introduced in R2018b

platformPlotter

Create platform plotter

Syntax

```
pPlotter = platformPlotter(tp)
pPlotter = platformPlotter(tp,Name,Value)
```

Description

`pPlotter = platformPlotter(tp)` creates a platform plotter for use with the theater plot, `tp`.

`pPlotter = platformPlotter(tp,Name,Value)` creates a platform plotter with additional options specified by one or more `Name, Value` pair arguments.

Examples

Create and Update Theater Plot Platforms

Create a theater plot.

```
tp = theaterPlot('XLim',[0,90],'YLim',[-35,35],'ZLim',[1,10]);
```

Create a platform plotter with the name 'Platforms'.

```
plotter = platformPlotter(tp,'DisplayName','Platforms');
```

Update the theater plot with three platforms labeled 'R1', 'R2', and 'R3'. Position the three platforms, in units of meters, at (30, 5, 4), (30, -10, 2), and (30, 15, 1), with corresponding velocities (in m/s) of (-10, 0, 2), (-10, 3, 1), and (-10, -4, 1), respectively.

```
positions = [30, 5, 4; 30, -10, 2; 30, 15, 1];
velocities = [-10, 0, 2; -10, 3, 1; -10, -4, 1];
labels = {'R1','R2','R3'};
plotPlatform(plotter, positions, velocities, labels);
```

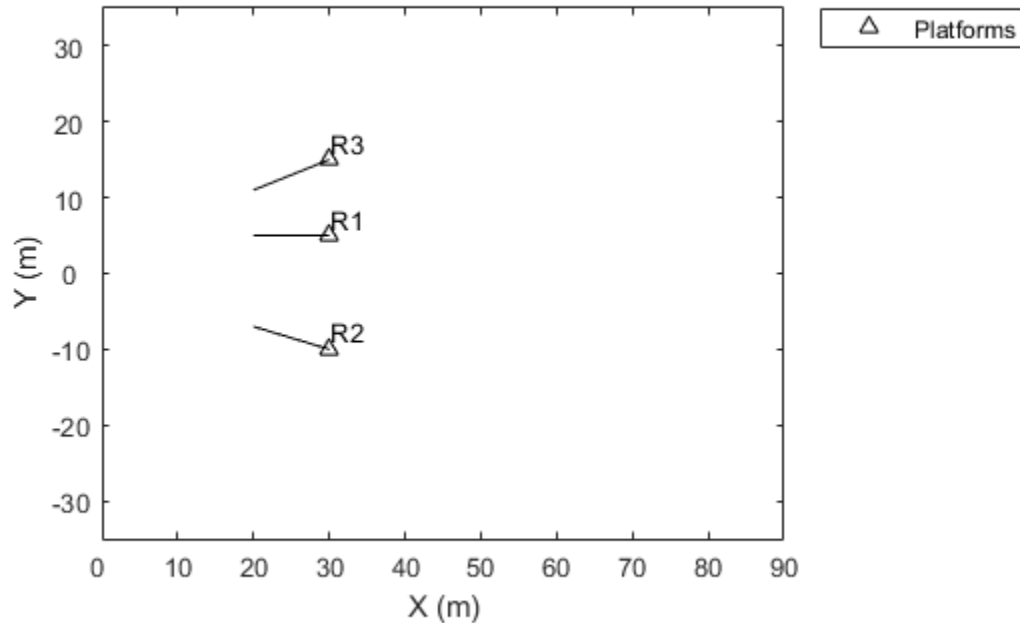

Input Arguments

tp — Theater plot

theaterPlot object

Theater plot, specified as a theaterPlot object.

Name-Value Pair Arguments

Specify optional comma-separated pairs of Name, Value arguments. Name is the argument name and Value is the corresponding value. Name must appear inside quotes. You can specify several name and value pair arguments in any order as Name1, Value1, ..., NameN, ValueN.

Example: 'MarkerSize', 10

DisplayName — Plot name to display in legend

character vector | string scalar

Plot name to display in legend, specified as the comma-separated pair consisting of 'DisplayName' and a character vector or string scalar. If no name is specified, no entry is shown.

Example: 'DisplayName', 'Radar Detections'

Marker — Marker symbol

'^' (default) | character vector | string scalar

Marker symbol, specified as the comma-separated pair consisting of 'Marker' and one of these values.

Value	Description
'o'	Circle
'+'	Plus sign
'*'	Asterisk
'.'	Point
'x'	Cross
'_'	Horizontal line
' '	Vertical line
'square' or 's'	Square
'diamond' or 'd'	Diamond
'^'	Upward-pointing triangle
'v'	Downward-pointing triangle
'>'	Right-pointing triangle
'<'	Left-pointing triangle
'pentagram' or 'p'	Five-pointed star (pentagram)
'hexagram' or 'h'	Six-pointed star (hexagram)
'none'	No markers

MarkerSize — Size of marker

6 | positive integer

Size of marker, specified as the comma-separated pair consisting of 'MarkerSize' and a positive integer in points.

MarkerEdgeColor — Marker outline color

'black' (default) | character vector | string scalar | RGB triplet | hexadecimal color code

Marker outline color, specified as the comma-separated pair consisting of 'MarkerEdgeColor' and a character vector, a string scalar, an RGB triplet, or a hexadecimal color code.

MarkerFaceColor — Marker fill color

'none' (default) | character vector | string scalar | RGB triplet | hexadecimal color code

Marker outline color, specified as the comma-separated pair consisting of 'MarkerFaceColor' and a character vector, a string scalar, an RGB triplet, a hexadecimal color code, or 'none'. The default is 'none'.

FontSize — Font size for labeling platforms

10 (default) | positive integer

Font size for labeling platforms, specified in font points size as the comma-separated pair consisting of 'FontSize' and a positive integer.

LabelOffset — Gap between label and positional point

[0 0 0] (default) | three-element row vector

Gap between label and positional point it annotates, specified as the comma-separated pair consisting of 'LabelOffset' and a three-element row vector. Specify the $[x\ y\ z]$ offset in meters.

VelocityScaling — Scale factor for magnitude length of velocity vectors

1 (default) | positive scalar

Scale factor for magnitude length of velocity vectors, specified as the comma-separated pair consisting of 'VelocityScaling' and a positive scalar. The plot renders the magnitude vector value as VK , where V is the magnitude of the velocity in meters per second, and K is the value of VelocityScaling.

Tag — Tag to associate with the plotter

'Plotter N ' (default) | character vector | string scalar

Tag to associate with the plotter, specified as the comma-separated pair consisting of 'Tag' and a character vector or string scalar. The default value is 'Plotter N ', where N is an integer that corresponds to the N th plotter associated with the theaterPlot.

Tags provide a way to identify plotter objects, for example when searching using findPlotter.

See Also

clearData | clearPlotterData | plotPlatform | theaterPlot

Introduced in R2018b

plotPlatform

Plot set of platforms in platform plotter

Syntax

```
plotPlatform(platPlotter,positions)
plotPlatform(platPlotter,positions,velocities)
plotPlatform(platPlotter,positions,labels)
plotPlatform(platPlotter,positions,velocities,labels)
plotPlatform(platPlotter,positions, __,dimensions,orientations)
plotPlatform(platPlotter,positions, __,meshes,orientations)
```

Description

`plotPlatform(platPlotter,positions)` specifies positions of M platforms whose positions are plotted by `platPlotter`. Specify the positions as an M -by-3 matrix, where each column of the matrix corresponds to the x -, y -, and z -coordinates of the platform locations.

`plotPlatform(platPlotter,positions,velocities)` also specifies the corresponding velocities of the platforms. Velocities are plotted as line vectors emanating from the positions of the platforms. If specified, velocities must have the same dimensions as positions.

`plotPlatform(platPlotter,positions,labels)` also specifies a cell vector of length M whose elements contain the text labels corresponding to the M platforms specified in the positions matrix. If omitted, no labels are plotted.

`plotPlatform(platPlotter,positions,velocities,labels)` specifies velocities and text labels corresponding to the M platforms specified in the positions matrix.

`plotPlatform(platPlotter,positions, __,dimensions,orientations)` specifies the dimension and orientation of each plotted platform.

`plotPlatform(platPlotter,positions, __,meshes,orientations)` specifies the extent of each platform using meshes.

Examples

Create and Update Theater Plot Platforms

Create a theater plot.

```
tp = theaterPlot('XLim',[0,90],'YLim',[-35,35],'ZLim',[1,10]);
```

Create a platform plotter with the name 'Platforms'.

```
plotter = platformPlotter(tp,'DisplayName','Platforms');
```

Update the theater plot with three platforms labeled 'R1', 'R2', and 'R3'. Position the three platforms, in units of meters, at (30, 5, 4), (30, -10, 2), and (30, 15, 1), with corresponding velocities (in m/s) of (-10, 0, 2), (-10, 3, 1), and (-10, -4, 1), respectively.

```

positions = [30, 5, 4; 30, -10, 2; 30, 15, 1];
velocities = [-10, 0, 2; -10, 3, 1; -10, -4, 1];
labels = {'R1', 'R2', 'R3'};
plotPlatform(plotter, positions, velocities, labels);

```

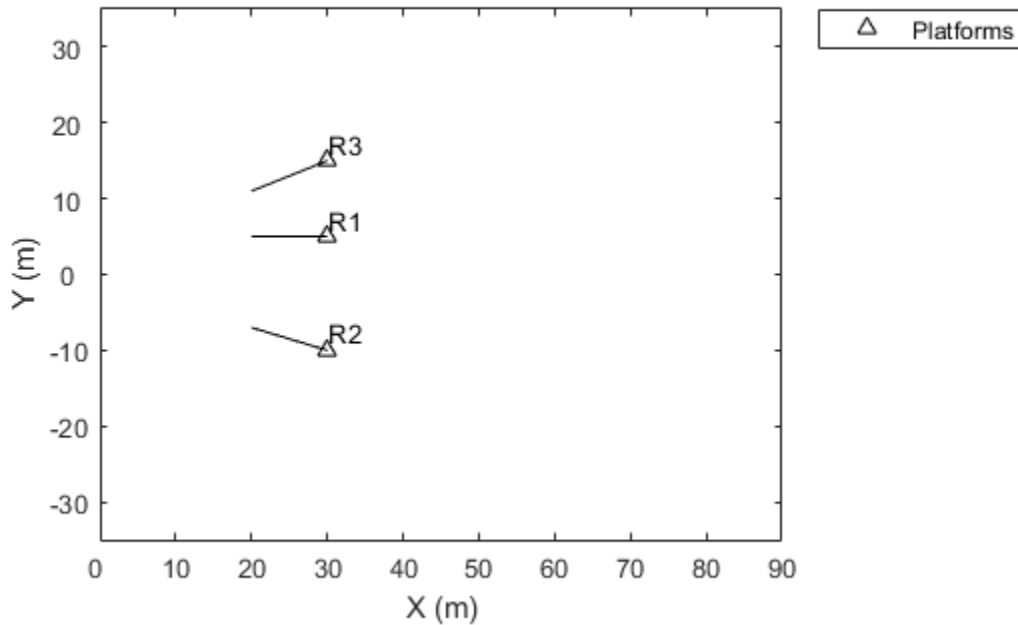

Input Arguments

platPlotter – Platform plotter

platformPlotter object

Platform plotter, specified as a platformPlotter object.

positions – Platform positions

real-valued matrix

Platform positions, specified as an M -by-3 real-valued matrix, where M is the number of platforms. Each column of the matrix corresponds to the x -, y -, and z -coordinates of the platform locations in meters.

velocities – Platform velocities

M -by-3 real-valued matrix

Platform velocities, specified as an M -by-3 real-valued matrix, where M is the number of platforms. Each column of the matrix corresponds to the x , y , and z velocities of the platforms. If specified, **velocities** must have the same dimensions as **positions**.

labels – Platform labels

cell array

Platform labels, specified as an M -by-1 cell array of character vectors, where M is the number of platforms. `labels` contains the text labels corresponding to the M platforms specified in `positions`. If `labels` is omitted, no labels are plotted.

dimensions – Platform dimensions M -by-1 array of dimension structure

Platform dimensions, specified as an M -by-1 array of dimension structures, where M is the number of platforms. The fields of each dimension structure are:

Fields of Dimensions

Fields	Description
Length	Dimension of a cuboid along the x direction
Width	Dimension of a cuboid along the y direction
Height	Dimension of a cuboid along the z direction
OriginOffset	Position of the platform coordinate frame origin with respect to the cuboid center, specified as a vector of three elements

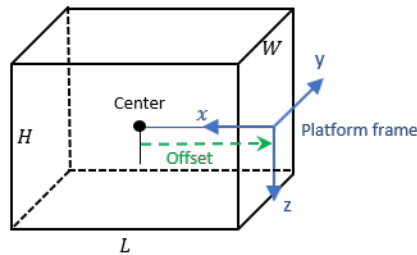
**meshes – Platform meshes** M -element array of `extendedObjectMesh` object

Platform meshes, specified as an M -element array of `extendedObjectMesh` objects.

orientations – Platform orientations 3 -by- 3 -by- M array of rotation matrix | M -element array of quaternion object

Platform orientations, specified as a 3 -by- 3 -by- M array of rotation matrices, or an M -element array of quaternion objects.

See Also

platformPlotter | theaterPlot

Introduced in R2018b

trackPlotter

Create track plotter

Syntax

```
tPlotter = trackPlotter(tp)  
tPlotter = trackPlotter(tp,Name,Value)
```

Description

`tPlotter = trackPlotter(tp)` creates a track plotter for use with the theater plot `tp`.

`tPlotter = trackPlotter(tp,Name,Value)` creates a track plotter with additional options specified by one or more `Name,Value` pair arguments.

Examples

Plot Tracks in Theater Plot

Create a theater plot. Create a track plotter with `DisplayName` set to 'Tracks' and with `HistoryDepth` set to 5.

```
tp = theaterPlot('XLim',[0,90],'YLim',[-35,35]);  
tPlotter = trackPlotter(tp,'DisplayName','Tracks','HistoryDepth',5);
```

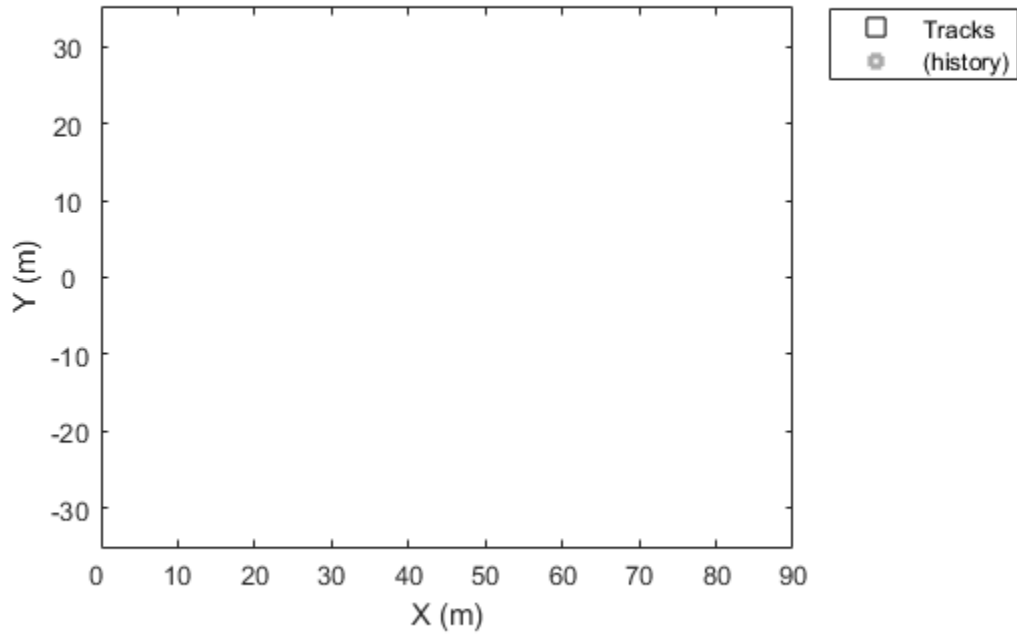

Update the track plotter with three tracks labeled 'T1', 'T2', and 'T3' with start positions in units of meters all starting at (30, 5, 1) with corresponding velocities (in m/s) of (3, 0, 1), (3, 2, 2) and (3, -3, 5), respectively. Update the tracks with the velocities for ten iterations.

```
positions = [30, 5, 1; 30, 5, 1; 30, 5, 1];
velocities = [3, 0, 1; 3, 2, 2; 3, -3, 5];
labels = {'T1', 'T2', 'T3'};
for i=1:10
    plotTrack(tPlotter, positions, velocities, labels)
    positions = positions + velocities;
end
```

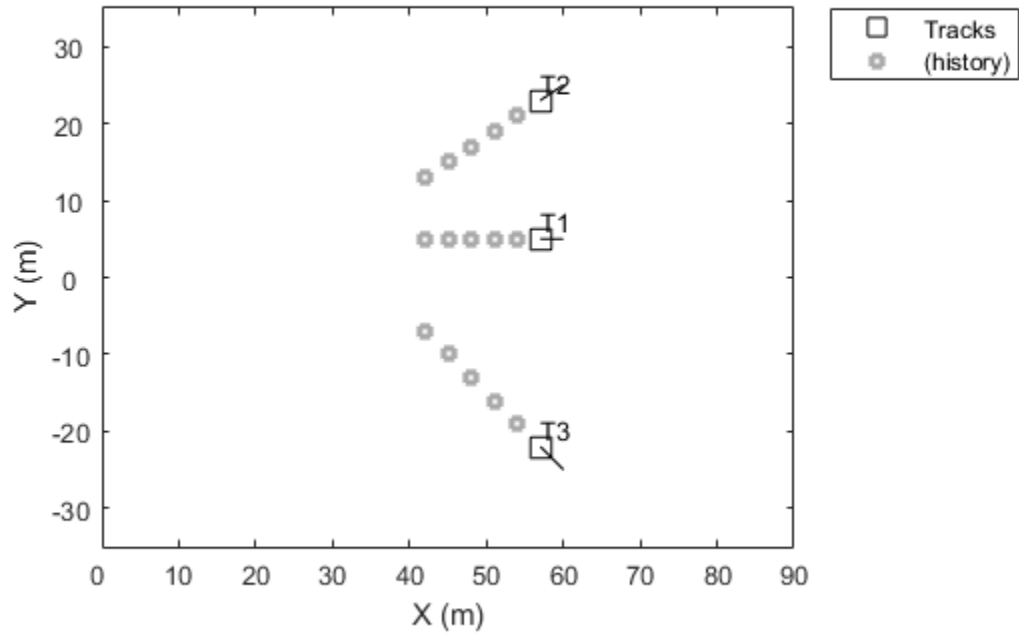

This animation loops through all the generated plots.

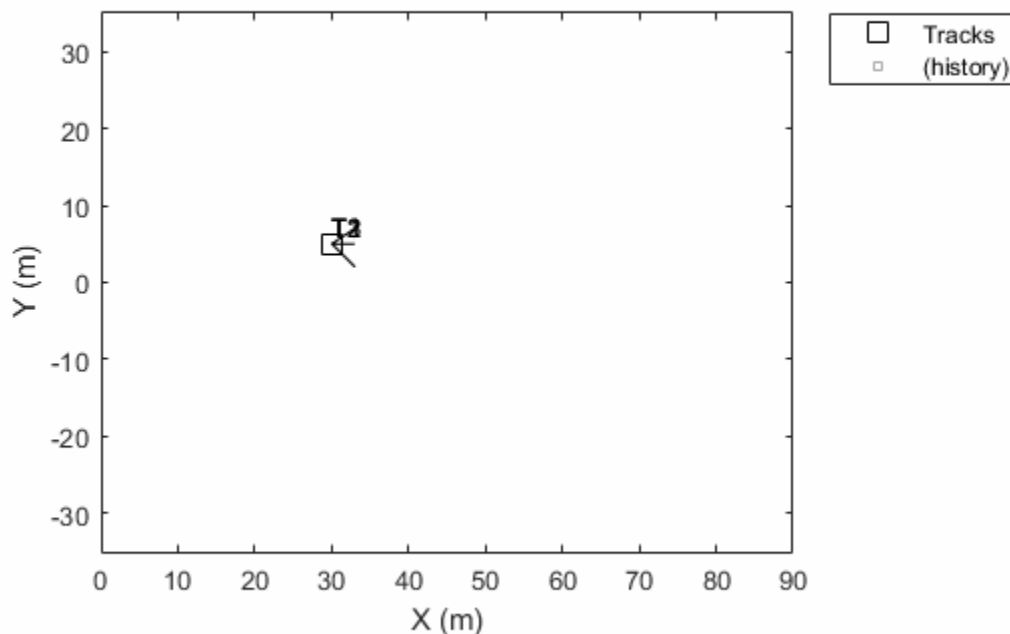

Input Arguments

tp — Theater plot

theaterPlot object

Theater plot, specified as a theaterPlot object.

Name-Value Pair Arguments

Specify optional comma-separated pairs of Name, Value arguments. Name is the argument name and Value is the corresponding value. Name must appear inside quotes. You can specify several name and value pair arguments in any order as Name1, Value1, ..., NameN, ValueN.

Example: 'MarkerSize', 10

DisplayName — Plot name to display in legend

character vector | string scalar

Plot name to display in legend, specified as the comma-separated pair consisting of 'DisplayName' and a character vector or string scalar. If no name is specified, no entry is shown.

Example: 'DisplayName', 'Radar Detections'

HistoryDepth — Number of previous track updates to display

0 (default) | nonnegative integer less than or equal to 10,000

Number of previous track updates to display, specified as the comma-separated pair consisting of 'HistoryDepth' and a nonnegative integer less than or equal to 10,000. If set to 0, then no previous updates are rendered.

ConnectHistory — Connect tracks flag

'off' (default) | 'on'

Connect tracks flag, specified as either 'on' or 'off'. When set to 'on', tracks with the same label or track identifier between consecutive updates are connected with a line. This property can only be specified when creating the `trackPlotter`. The default is 'off'.

To use the trackIDs on page 2-0 input argument of `plotTrack`, 'ConnectHistory' must be 'on'. If trackIDs on page 2-0 is omitted when 'ConnectHistory' is 'on', then the track identifiers are derived from the labels input instead.

ColorizeHistory — Colorize track history

'off' (default) | 'on'

Colorize track history, specified as either 'on' or 'off'. When set to 'on', tracks with the same label or track identifier between consecutive updates are connected with a line of a different color. This property can only be specified when creating the `trackPlotter`. The default is 'off'.

ColorizedHistory is applicable only when ConnectHistory is 'on'.

Marker — Marker symbol

's' (default) | character vector | string scalar

Marker symbol, specified as the comma-separated pair consisting of 'Marker' and one of these symbols.

Value	Description
'o'	Circle
'+'	Plus sign
'*'	Asterisk
'.'	Point
'x'	Cross
'_'	Horizontal line
' '	Vertical line
'square' or 's'	Square
'diamond' or 'd'	Diamond
'^'	Upward-pointing triangle
'v'	Downward-pointing triangle
'>'	Right-pointing triangle
'<'	Left-pointing triangle
'pentagram' or 'p'	Five-pointed star (pentagram)
'hexagram' or 'h'	Six-pointed star (hexagram)
'none'	No markers

MarkerSize — Size of marker

10 (default) | positive integer

Size of marker, specified as the comma-separated pair consisting of 'MarkerSize' and a positive integer in points.

MarkerEdgeColor — Marker outline color

'black' (default) | character vector | string scalar | RGB triplet | hexadecimal color code

Marker outline color, specified as the comma-separated pair consisting of 'MarkerEdgeColor' and a character vector, a string scalar, an RGB triplet, or a hexadecimal color code.

MarkerFaceColor — Marker fill color

'none' (default) | character vector | string scalar | RGB triplet | hexadecimal color code

Marker outline color, specified as the comma-separated pair consisting of 'MarkerFaceColor' and a character vector, a string scalar, an RGB triplet, a hexadecimal color code, or 'none'. The default is 'none'.

FontSize — Font size for labeling tracks

10 (default) | positive integer

Font size for labeling tracks, specified as the comma-separated pair consisting of 'FontSize' and a positive integer that represents font point size.

LabelOffset — Gap between label and positional point

[0 0 0] (default) | three-element row vector

Gap between label and positional point it annotates, specified as the comma-separated pair consisting of 'LabelOffset' and a three-element row vector. Specify the [x y z] offset in meters.

VelocityScaling — Scale factor for magnitude length of velocity vectors

1 (default) | positive scalar

Scale factor for magnitude length of velocity vectors, specified as the comma-separated pair consisting of 'VelocityScaling' and a positive scalar. The plot renders the magnitude vector value as VK , where V is the magnitude of the velocity in meters per second, and K is the value of VelocityScaling.

Tag — Tag to associate with the plotter

'PlotterN' (default) | character vector | string scalar

Tag to associate with the plotter, specified as the comma-separated pair consisting of 'Tag' and a character vector or string scalar. The default value is 'PlotterN', where N is an integer that corresponds to the N th plotter associated with the theaterPlot.

Tags provide a way to identify plotter objects, for example when searching using findPlotter.

See Also

clearData | clearPlotterData | plotTrack | theaterPlot

Introduced in R2018b

plotTrack

Plot set of tracks in theater track plotter

Syntax

```
plotTrack(tPlotter,positions)
plotTrack(tPlotter,positions,velocities)
plotTrack( ____,covariances)
plotTrack(tPlotter,positions, ____,labels)
plotTrack(tPlotter,positions, ____,labels,trackIDs)
plotTrack(tPlotter,positions, ____,dimensions,orientations)
```

Description

`plotTrack(tPlotter,positions)` specifies positions of M tracked objects whose positions are plotted by the track plotter `tPlotter`. Specify the positions as an M -by-3 matrix, where each column of positions corresponds to the x -, y -, and z -coordinates of the object locations.

`plotTrack(tPlotter,positions,velocities)` also specifies the corresponding velocities of the objects. Velocities are plotted as line vectors emanating from the positions of the detections. If specified, `velocities` must have the same dimensions as `positions`. If unspecified, no velocity information is plotted.

`plotTrack(____,covariances)` also specifies the covariances of the M track uncertainties. The input argument `covariances` is a 3-by-3-by- M array of covariances that are centered at the track positions. The uncertainties are plotted as an ellipsoid. You can use this syntax with any of the previous syntaxes.

`plotTrack(tPlotter,positions, ____,labels)` also specifies the labels and positions of the M objects whose positions are estimated by a tracker. The input argument `labels` is an M -by-1 cell array of character vectors that correspond to the M detections specified in `positions`. If omitted, no labels are plotted.

`plotTrack(tPlotter,positions, ____,labels,trackIDs)` also specifies the unique track identifiers for each track when the 'ConnectHistory' on page 2-0 property of `tPlotter` is set to 'on'. The input argument `trackIDs` can be an M -by-1 array of unique integer values, an M -by-1 array of strings, or an M -by-1 cell array of unique character vectors.

If `trackIDs` is omitted when 'ConnectHistory' is 'on', then the track identifiers are derived from the labels input instead. The `trackIDs` input is ignored when 'ConnectHistory' is 'off'.

`plotTrack(tPlotter,positions, ____,dimensions,orientations)` specifies the dimension and orientation of each tracked object in the plot.

Examples

Plot Tracks in Theater Plot

Create a theater plot. Create a track plotter with `DisplayName` set to 'Tracks' and with `HistoryDepth` set to 5.

```
tp = theaterPlot('XLim',[0,90],'YLim',[-35,35]);
tPlotter = trackPlotter(tp,'DisplayName','Tracks','HistoryDepth',5);
```

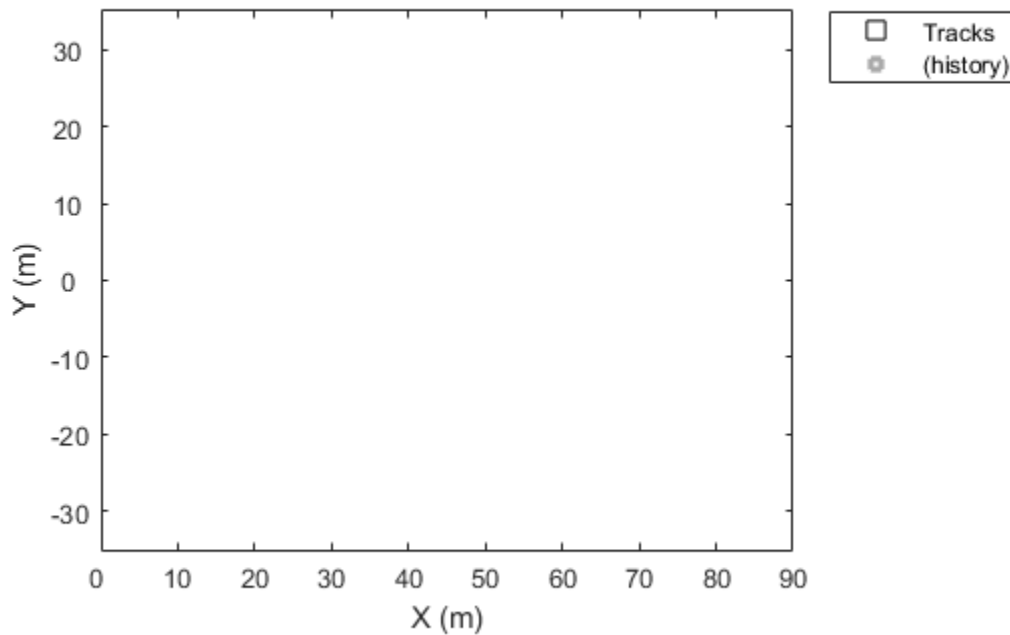

Update the track plotter with three tracks labeled 'T1', 'T2', and 'T3' with start positions in units of meters all starting at (30, 5, 1) with corresponding velocities (in m/s) of (3, 0, 1), (3, 2, 2) and (3, -3, 5), respectively. Update the tracks with the velocities for ten iterations.

```
positions = [30, 5, 1; 30, 5, 1; 30, 5, 1];
velocities = [3, 0, 1; 3, 2, 2; 3, -3, 5];
labels = {'T1','T2','T3'};
for i=1:10
    plotTrack(tPlotter, positions, velocities, labels)
    positions = positions + velocities;
end
```

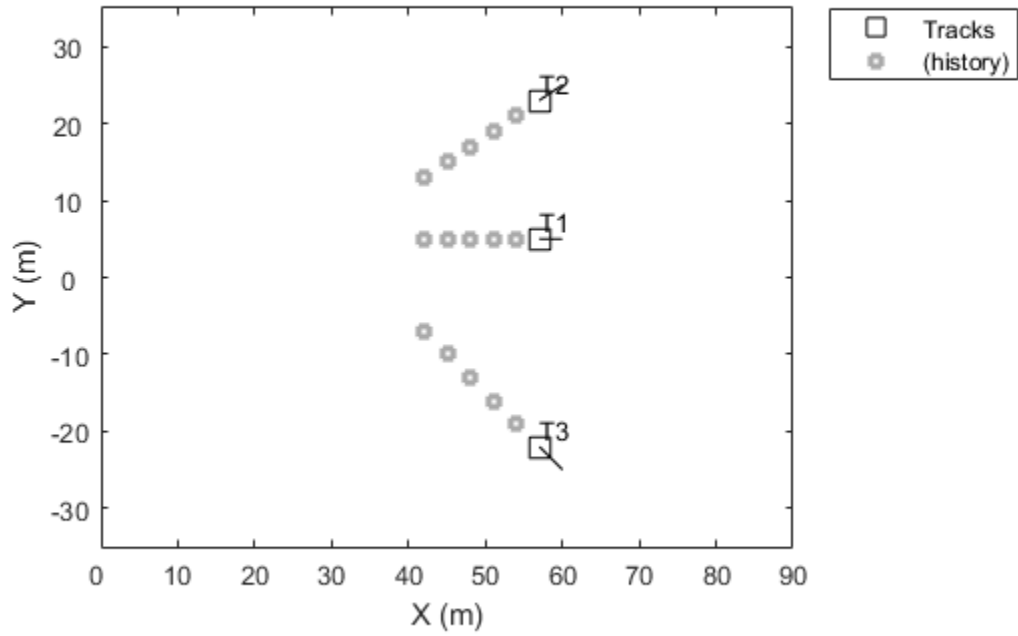

This animation loops through all the generated plots.

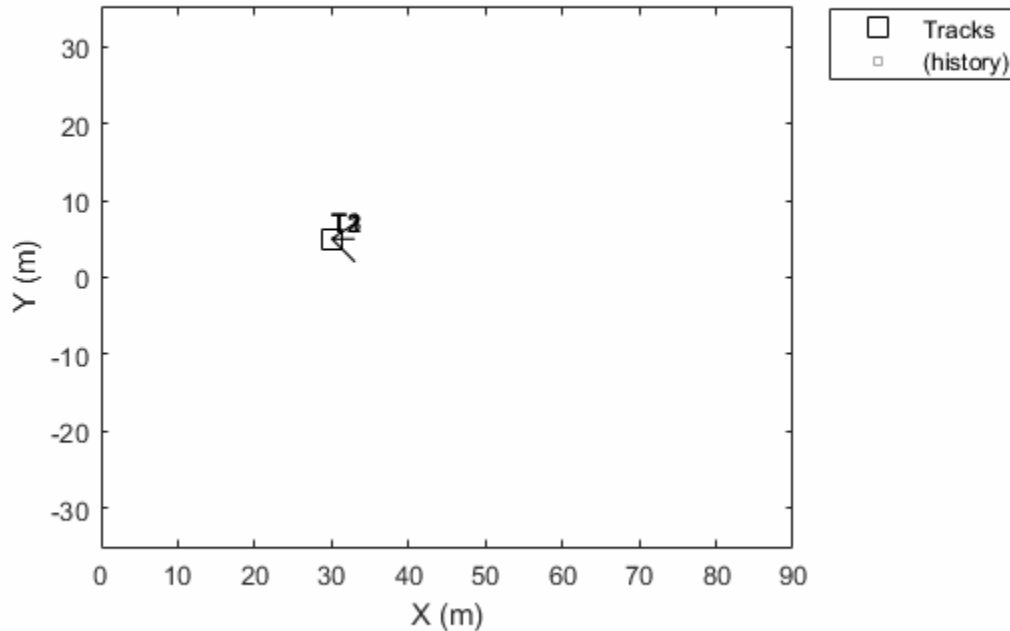

Plot Track Uncertainties

Create a theater plot. Create a track plotter with `DisplayName` set to 'Uncertain Track'.

```
tp = theaterPlot('Xlim',[0 5], 'Ylim',[0 5]);
tPlotter = trackPlotter(tp, 'DisplayName', 'Uncertain Track');
```

Update the track plotter with a track at a position in meters (2,2,1) and velocity (in meters/second) of (1,1,3). Also create a random 3-by-3 covariance matrix representing track uncertainties. For purposes of reproducibility, set the random seed to the default value.

```
positions = [2, 2, 1];
velocities = [1, 1, 3];
rng default
covariances = randn(3,3);
```

Plot the track with the covariances plotted as an ellipsoid.

```
plotTrack(tPlotter, positions, velocities, covariances)
```

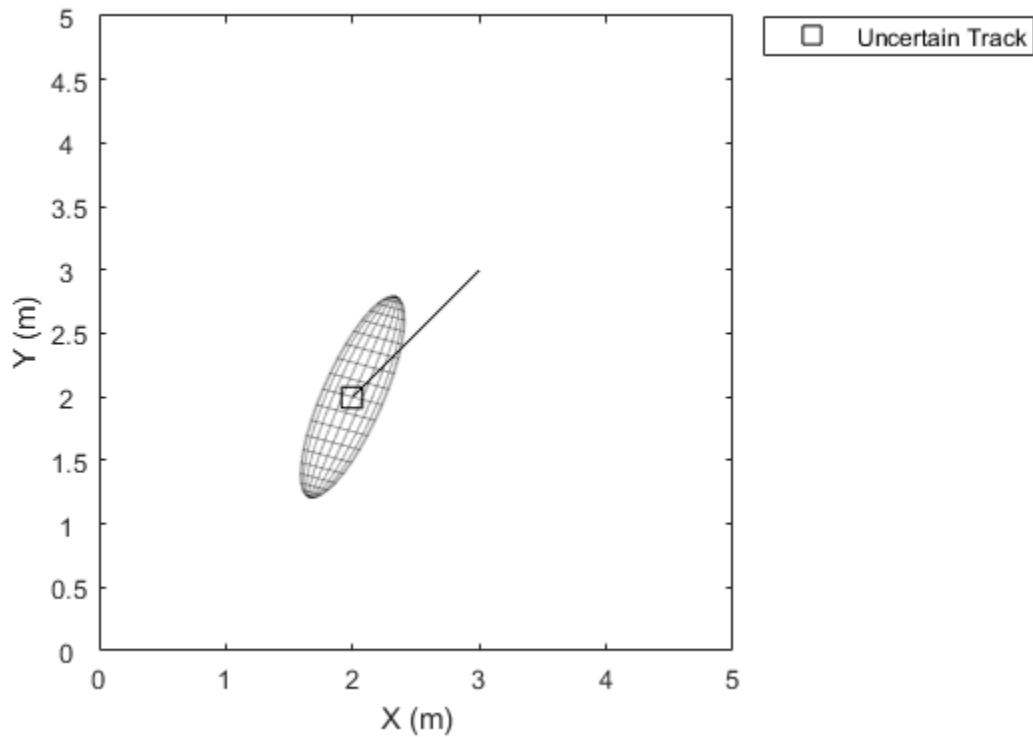

Input Arguments

tPlotter — Track plotter

trackPlotter object

Track plotter, specified as a trackPlotter object.

positions — Tracked object positions

real-valued matrix

Tracked object positions, specified as an M -by-3 real-valued matrix, where M is the number of objects. Each column of `positions` corresponds to the x -, y -, and z -coordinates of the object locations in meters.

velocities — Tracked object velocities

real-valued matrix

Tracked object velocities, specified as an M -by-3 real-valued matrix, where M is the number of objects. Each column of `velocities` corresponds to the x -, y -, and z velocities of the objects. If specified, `velocities` must have the same dimensions as `positions`.

covariances — Track uncertainties

real-valued array

Track uncertainties of M tracked objects, specified as a 3-by-3-by- M real-valued array of covariances. The covariances are centered at the track positions, and are plotted as an ellipsoid.

Labels — Tracked object labels

cell array

Tracked object labels, specified as a M -by-1 cell array of character vectors, where M is the number of objects. The argument `labels` contains the text labels corresponding to the M objects specified in `positions`. If `labels` is omitted, no labels are plotted.

trackIDs — Unique track identifiers

integer vector | string array | cell array

Unique track identifiers for the M tracked objects, specified as an M -by-1 integer vector, an M -by-1 array of strings, or an M -by-1 cell array of character vectors. The elements of `trackIDs` must be unique.

The `trackIDs` input is ignored when the property 'ConnectHistory' of `tPlotter` is 'off'. If `trackIDs` is omitted when 'ConnectHistory' is 'on', then the track identifiers are derived from the labels input instead.

dimensions — Platform dimensions

M -by-1 array of dimension structure

Platform dimensions, specified as an M -by-1 array of dimension structures, where M is the number of platforms. The fields of each dimension structure are:

Fields of Dimensions

Fields	Description
Length	Dimension of a cuboid along the x direction
Width	Dimension of a cuboid along the y direction
Height	Dimension of a cuboid along the z direction
OriginOffset	Position of the platform coordinate frame origin with respect to the cuboid center, specified as a vector of three elements

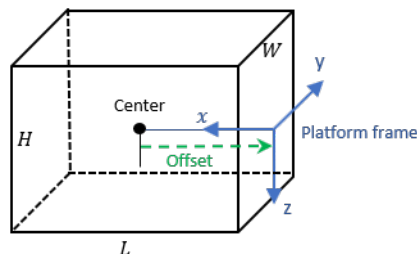

orientations — Platform orientations

3-by-3-by- M array of rotation matrix | M -element array of quaternion object

Platform orientations, specified as a 3-by-3-by- M array of rotation matrices, or an M -element array of quaternion objects.

See Also

`clearData` | `clearPlotterData` | `theaterPlot` | `trackPlotter`

Introduced in R2018b

trajectoryPlotter

Create trajectory plotter

Syntax

```
trajPlotter = trajectoryPlotter(tp)
trajPlotter = trajectoryPlotter(tp,Name,Value)
```

Description

`trajPlotter = trajectoryPlotter(tp)` creates a trajectory plotter for use with the theater plot `tp`.

`trajPlotter = trajectoryPlotter(tp,Name,Value)` creates a trajectory plotter with additional options specified by one or more `Name,Value` pair arguments.

Examples

Moving Platform on Trajectory in trackingScenario

This example shows how to create an animation of a platform moving on a trajectory.

First, create a `trackingScenario` and add waypoints for a trajectory.

```
ts = trackingScenario;
height = 100;
d = 1;
wayPoints = [ ...
    -30  -25  height;
    -30   25-d height;
    -30+d 25   height;
    -10-d 25   height;
    -10   25-d height;
    -10  -25+d height;
    -10+d -25  height;
    10-d -25  height;
    10   -25+d height;
    10   25-d height;
    10+d 25   height;
    30-d 25   height;
    30   25-d height;
    30  -25+d height;
    30  -25  height];
```

Specify a time for each waypoint.

```
elapsedTime = linspace(0,10,size(wayPoints,1));
```

Next, create a platform in the tracking scenario and add trajectory information using the `trajectory` method.

```
target = platform(ts);
traj = waypointTrajectory('Waypoints',wayPoints,'TimeOfArrival',elapsedTime);
target.Trajectory = traj;
```

Record the tracking scenario to retrieve the platform's trajectory.

```
r = record(ts);
pposes = [r(:).Poses];
pposition = vertcat(pposes.Position);
```

Create a theater plot to display the recorded trajectory.

```
tp = theaterPlot('XLim',[-40 40],'YLim',[-40 40]);
trajPlotter = trajectoryPlotter(tp,'DisplayName','Trajectory');
plotTrajectory(trajPlotter,{pposition})
```

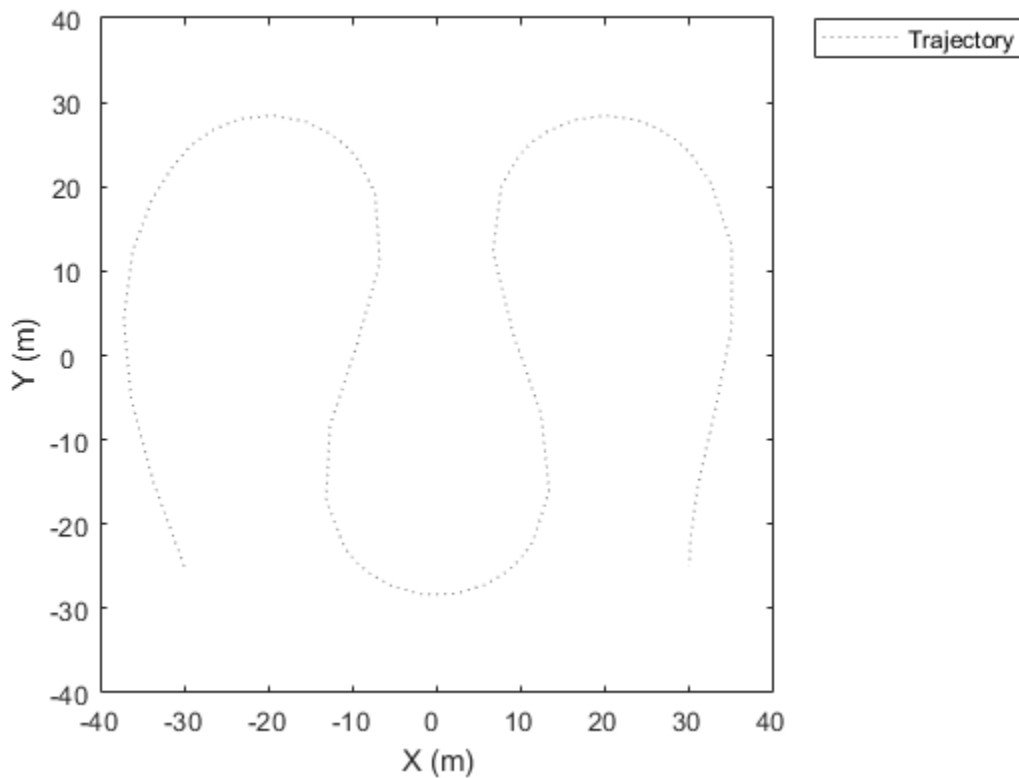

Animate using the platformPlotter.

```
restart(ts);
trajPlotter = platformPlotter(tp,'DisplayName','Platform');

while advance(ts)
    p = pose(target,'true');
    plotPlatform(trajPlotter, p.Position);
    pause(0.1)
end
```

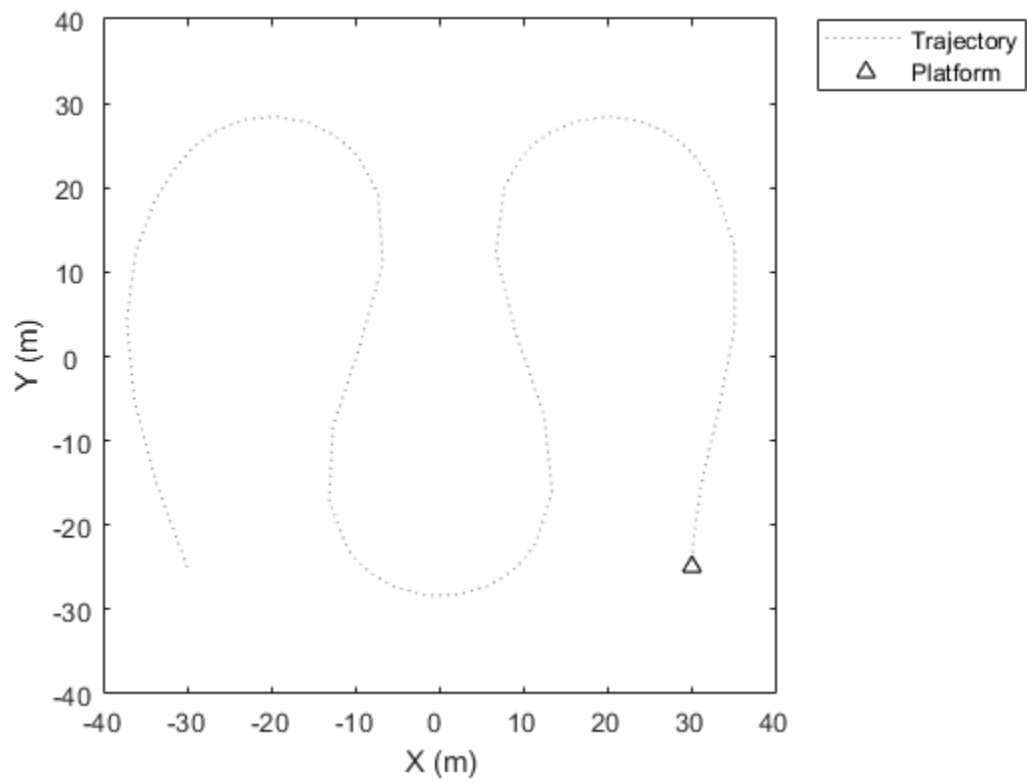
This animation loops through all the generated plots.

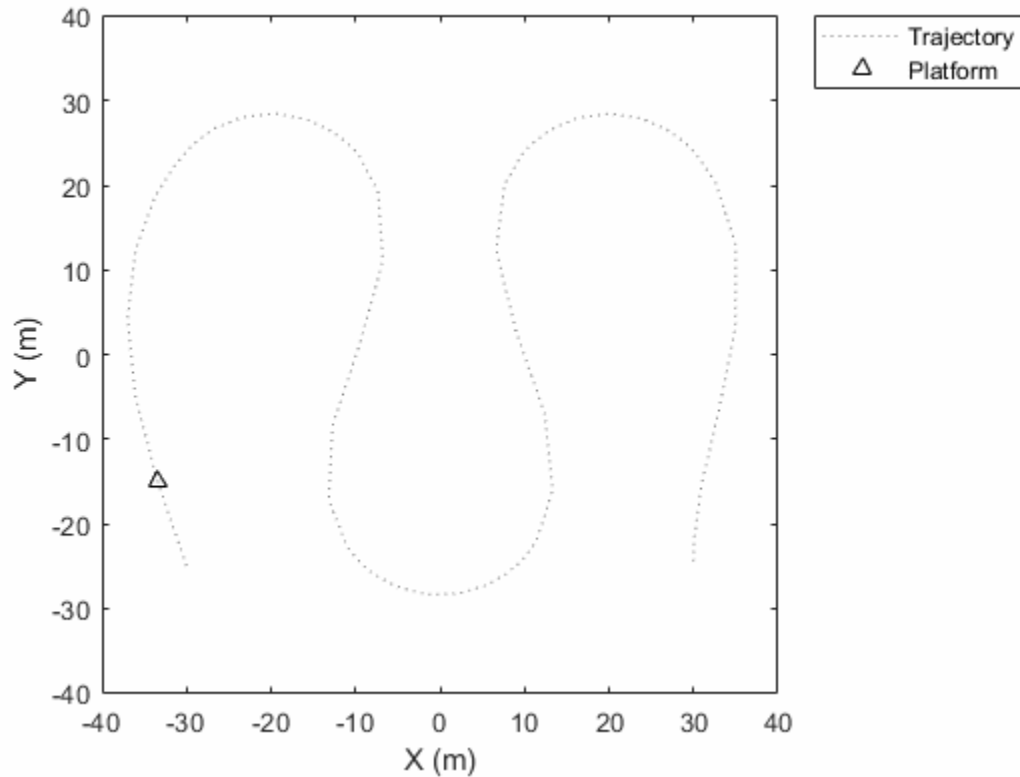

Input Arguments

tp — Theater plot

theaterPlot object

Theater plot, specified as a theaterPlot object.

Name-Value Pair Arguments

Specify optional comma-separated pairs of Name, Value arguments. Name is the argument name and Value is the corresponding value. Name must appear inside quotes. You can specify several name and value pair arguments in any order as Name1, Value1, ..., NameN, ValueN.

Example: 'LineStyle', '--'

DisplayName — Plot name to display in legend

character vector | string scalar

Plot name to display in legend, specified as the comma-separated pair consisting of 'DisplayName' and a character vector or string scalar. If no name is specified, no entry is shown.

Example: 'DisplayName', 'Radar Detections'

Color — Trajectory color

'gray' (default) | character vector | string scalar | RGB triplet | hexadecimal color code

Trajectory color, specified as the comma-separated pair consisting of 'Color' and a character vector, a string scalar, an RGB triplet, or a hexadecimal color code.

LineStyle – Line style

' : ' (default) | ' - ' | ' - - ' | ' - . '

Line style used to plot the trajectory, specified as one of these values.

Value	Description
' : '	Dotted line (default)
' - '	Solid line
' - - '	Dashed line
' - . '	Dash-dotted line

LineWidth – Line width

0.5 (default) | positive scalar

Line width of the trajectory, specified in points size as the comma-separated pair consisting of 'LineWidth' and a positive scalar.

Tag – Tag to associate with the plotter

'PlotterN' (default) | character vector | string scalar

Tag to associate with the plotter, specified as the comma-separated pair consisting of 'Tag' and a character vector or string scalar. The default value is 'PlotterN', where *N* is an integer that corresponds to the *N*th plotter associated with the theaterPlot.

Tags provide a way to identify plotter objects, for example when searching using findPlotter.

See Also

clearData | clearPlotterData | plotTrajectory | theaterPlot

Introduced in R2018b

plotTrajectory

Plot set of trajectories in trajectory plotter

Syntax

```
plotTrajectory(trajPlotter, trajCoordList)
```

Description

`plotTrajectory(trajPlotter, trajCoordList)` specifies the trajectories to show in the trajectory plotter, `trajPlotter`. The input argument `trajCoordList` is a cell array of M -by-3 matrices, where M is the number of points in the trajectory. Each matrix in `trajCoordList` can have a different number of rows. The first, second, and third columns of each matrix correspond to the x -, y -, and z -coordinates of a curve through M points that represent the corresponding trajectory.

Examples

Moving Platform on Trajectory in trackingScenario

This example shows how to create an animation of a platform moving on a trajectory.

First, create a `trackingScenario` and add waypoints for a trajectory.

```
ts = trackingScenario;
height = 100;
d = 1;
wayPoints = [ ...
    -30  -25  height;
    -30   25-d height;
    -30+d 25  height;
    -10-d 25  height;
    -10   25-d height;
    -10  -25+d height;
    -10+d -25  height;
    10-d -25  height;
    10   -25+d height;
    10   25-d height;
    10+d 25  height;
    30-d 25  height;
    30   25-d height;
    30  -25+d height;
    30  -25  height];
```

Specify a time for each waypoint.

```
elapsedTime = linspace(0,10,size(wayPoints,1));
```

Next, create a platform in the tracking scenario and add trajectory information using the `trajectory` method.

```
target = platform(ts);
traj = waypointTrajectory('Waypoints',wayPoints,'TimeOfArrival',elapsedTime);
target.Trajectory = traj;
```

Record the tracking scenario to retrieve the platform's trajectory.

```
r = record(ts);
pposes = [r(:).Poses];
pposition = vertcat(pposes.Position);
```

Create a theater plot to display the recorded trajectory.

```
tp = theaterPlot('XLim',[-40 40],'YLim',[-40 40]);
trajPlotter = trajectoryPlotter(tp,'DisplayName','Trajectory');
plotTrajectory(trajPlotter,{pposition})
```

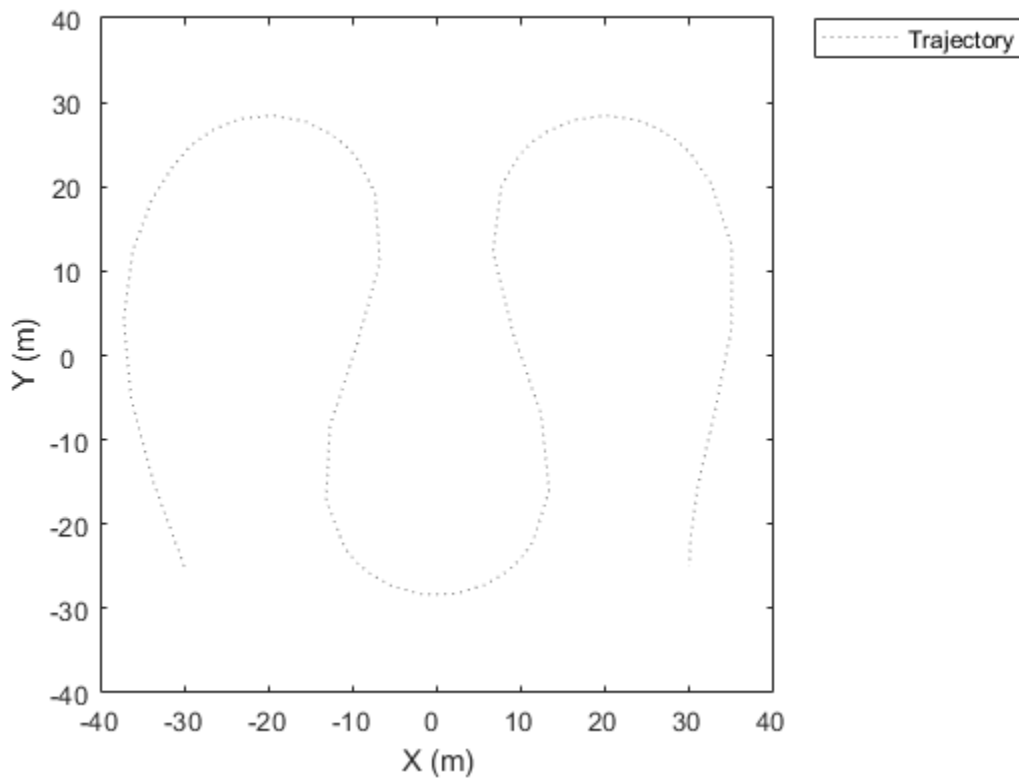

Animate using the platformPlotter.

```
restart(ts);
trajPlotter = platformPlotter(tp,'DisplayName','Platform');
```

```
while advance(ts)
    p = pose(target,'true');
    plotPlatform(trajPlotter, p.Position);
    pause(0.1)
```

```
end
```

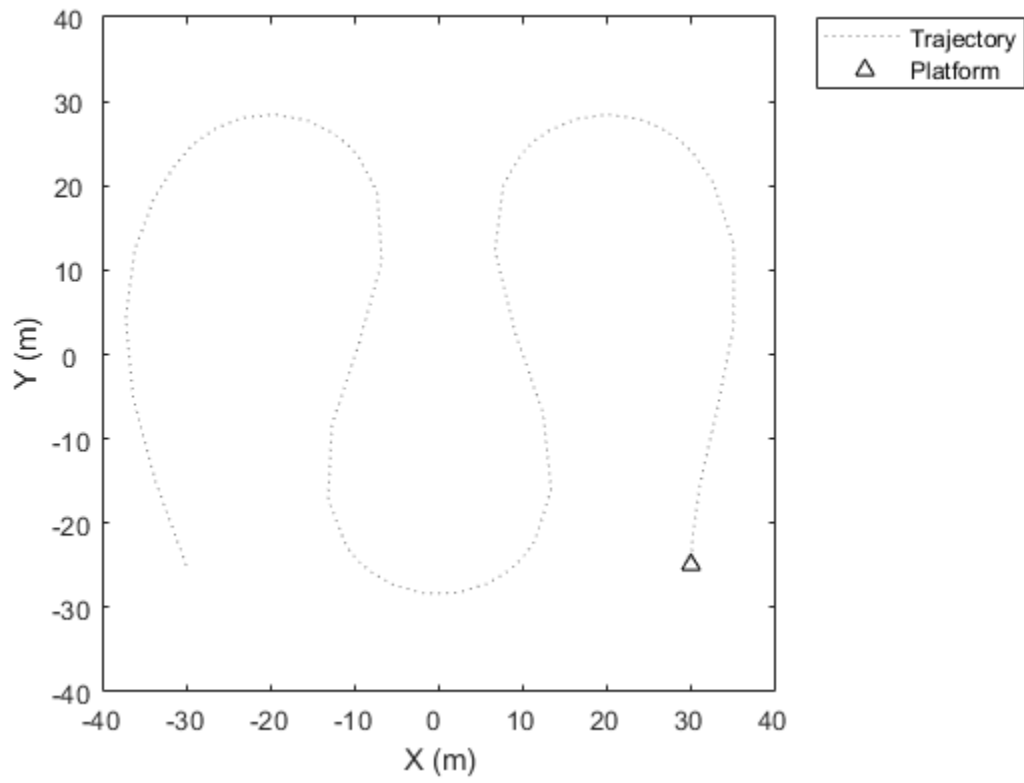

This animation loops through all the generated plots.

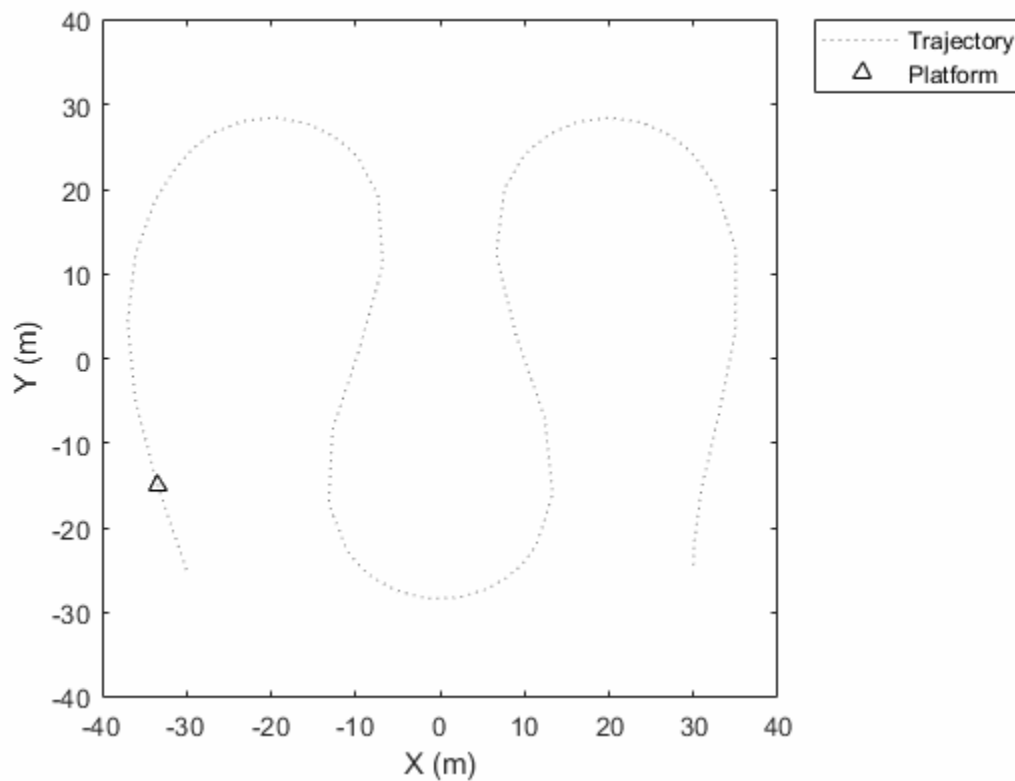

Input Arguments

trajPlotter — Trajectory plotter

trajectoryPlotter object

Trajectory plotter, specified as a trajectoryPlotter object.

trajCoordList — Coordinates of trajectories

cell array

Coordinates of trajectories to show, specified as a cell array of M -by-3 matrices, where M is the number of points in the trajectory. Each matrix in `trajCoordList` can have a different number of rows. The first, second, and third columns of each matrix correspond to the x -, y -, and z -coordinates of a curve through M points that represent the corresponding trajectory.

Example: `coordList = {[1 2 3; 4 5 6; 7,8,9];[4 2 1; 4 3 1];[4 4 4; 3 1 2; 9 9 9; 1 0 2]}` specifies three different trajectories.

See Also

`clearData` | `clearPlotterData` | `theaterPlot` | `trajectoryPlotter`

Introduced in R2018b

trackingABF

Alpha-beta filter for object tracking

Description

The `trackingABF` object represents an alpha-beta filter designed for object tracking for an object that follows a linear motion model and has a linear measurement model. Linear motion is defined by constant velocity or constant acceleration. Use the filter to predict the future location of an object, to reduce noise for a detected location, or to help associate multiple objects with their tracks.

Creation

Syntax

```
abf = trackingABF
abf = trackingABF(Name,Value)
```

Description

`abf = trackingABF` returns an alpha-beta filter for a discrete time, 2-D constant velocity system. The motion model is named `'2D Constant Velocity'` with the state defined as $[x; vx; y; vy]$.

`abf = trackingABF(Name,Value)` specifies the properties of the filter using one or more `Name,Value` pair arguments. Any unspecified properties take default values.

Properties

MotionModel — Model of target motion

`'2D Constant Velocity'` (default) | `'1D Constant Velocity'` | `'3D Constant Velocity'` | `'1D Constant Acceleration'` | `'2D Constant Acceleration'` | `'3D Constant Acceleration'`

Model of target motion, specified as a character vector or string. Specifying 1D, 2D, or 3D specifies the dimension of the target's motion. Specifying `Constant Velocity` assumes that the target motion is a constant velocity at each simulation step. Specifying `Constant Acceleration` assumes that the target motion is a constant acceleration at each simulation step.

Data Types: `char` | `string`

State — Filter state

real-valued M -element vector | scalar

Filter state, specified as a real-valued M -element vector. A scalar input is extended to an M -element vector. The state vector is the concatenated states from each dimension. For example, if `MotionModel` is set to `'3D Constant Acceleration'`, the state vector is in the form: $[x; x'; x''; y; y'; y''; z; z'; z'']$ where `'` and `''` indicate first and second order derivatives, respectively.

Example: [200;0.2;150;0.1;0;0.25]

Data Types: double

StateCovariance — State estimation error covariance

M-by-*M* matrix | scalar

State error covariance, specified as an *M*-by-*M* matrix, where *M* is the size of the filter state. A scalar input is extended to an *M*-by-*M* matrix. The covariance matrix represents the uncertainty in the filter state.

Example: eye(6)

ProcessNoise — Process noise covariance

D-by-*D* matrix | scalar

Process noise covariance, specified as a scalar or a *D*-by-*D* matrix, where *D* is the dimensionality of motion. For example, if `MotionModel` is '2D Constant Velocity', then *D* = 2. A scalar input is extended to a *D*-by-*D* matrix.

Example: [20 0.1; 0.1 1]

MeasurementNoise — Measurement noise covariance

D-by-*D* matrix | scalar

Measurement noise covariance, specified as a scalar or a *D*-by-*D* matrix, where *D* is the dimensionality of motion. For example, if `MotionModel` is '2D Constant Velocity', then *D* = 2. A scalar input is extended to a *M*-by-*M* matrix.

Example: [20 0.1; 0.1 1]

Coefficients — Alpha-beta filter coefficients

row vector | scalar

Alpha-beta filter coefficients, specified as a scalar or row vector. A scalar input is extended to a row vector. If you specify constant velocity in the `MotionModel` property, the coefficients are [alpha beta]. If you specify constant acceleration in the `MotionModel` property, the coefficients are [alpha beta gamma].

Example: [20 0.1]

EnableSmoothing — Enable state smoothing

false (default) | true

Enable state smoothing, specified as false or true. Setting this property to true requires the Sensor Fusion and Tracking Toolbox license. When specified as true, you can:

- Use the `smooth` function, provided in Sensor Fusion and Tracking Toolbox, to smooth state estimates in the previous steps. Internally, the filter stores the results from previous steps to allow backward smoothing.
- Specify the maximum number of smoothing steps using the `MaxNumSmoothingSteps` property of the tracking filter.

MaxNumSmoothingSteps — Maximum number of smoothing steps

5 (default) | positive integer

Maximum number of backward smoothing steps, specified as a positive integer.

Dependencies

To enable this property, set the `EnableSmoothing` property to `true`.

Object Functions

<code>predict</code>	Predict state and state estimation error covariance of tracking filter
<code>correct</code>	Correct state and state estimation error covariance using tracking filter
<code>correctjpda</code>	Correct state and state estimation error covariance using tracking filter and JPDA
<code>distance</code>	Distances between current and predicted measurements of tracking filter
<code>likelihood</code>	Likelihood of measurement from tracking filter
<code>smooth</code>	Backward smooth state estimates of tracking filter
<code>clone</code>	Create duplicate tracking filter

Examples

Run trackingABF Filter

This example shows how to create and run a `trackingABF` filter. Call the `predict` and `correct` functions to track an object and correct the state estimation based on measurements.

Create the filter. Specify the initial state.

```
state = [1;2;3;4];  
abf = trackingABF('State',state);
```

Call `predict` to get the predicted state and covariance of the filter. Use a 0.5 sec time step.

```
[xPred,pPred] = predict(abf, 0.5);
```

Call `correct` with a given measurement.

```
meas = [1;1];  
[xCorr,pCorr] = correct(abf, meas);
```

Continue to predict the filter state. Specify the desired time step in seconds if necessary.

```
[xPred,pPred] = predict(abf);           % Predict over 1 second  
[xPred,pPred] = predict(abf,2);       % Predict over 2 seconds
```

Modify the filter coefficients and correct again with a new measurement.

```
abf.Coefficients = [0.4 0.2];  
[xCorr,pCorr] = correct(abf,[8;14]);
```

References

- [1] Blackman, Samuel S. "Multiple-target tracking with radar applications." Dedham, MA, Artech House, Inc., 1986, 463 p. (1986).
- [2] Bar-Shalom, Yaakov, X. Rong Li, and Thiagalingam Kirubarajan. *Estimation with applications to tracking and navigation: theory algorithms and software*. John Wiley & Sons, 2004.

Extended Capabilities

C/C++ Code Generation

Generate C and C++ code using MATLAB® Coder™.

See Also

Objects

[trackerGNN](#) | [trackerTOMHT](#) | [trackingABF](#) | [trackingCKF](#) | [trackingEKF](#) | [trackingGSF](#) | [trackingIMM](#) | [trackingKF](#) | [trackingMSCEKF](#) | [trackingPF](#) | [trackingUKF](#)

Introduced in R2018b

trackingCKF

Cubature Kalman filter for object tracking

Description

The `trackingCKF` object represents a cubature Kalman filter designed for tracking objects that follow a nonlinear motion model or are measured by a nonlinear measurement model. Use the filter to predict the future location of an object, to reduce noise in a measured location, or to help associate multiple object detections with their tracks.

The cubature Kalman filter estimates the uncertainty of the state and the propagation of that uncertainty through the nonlinear state and measurement equations. There are a fixed number of cubature points chosen based on the spherical-radial transformation to guarantee an exact approximation of a Gaussian distribution up to the third moment. As a result, the corresponding filter is the same as an unscented Kalman filter, `trackingUKF`, with $\text{Alpha} = 1$, $\text{Beta} = 0$, and $\text{Kappa} = 0$.

Creation

Syntax

```
ckf = trackingCKF
ckf = trackingCKF(transitionFcn,measurementFcn,state)
ckf = trackingCKF( ___,Name,Value)
```

Description

`ckf = trackingCKF` returns a cubature Kalman filter object with default state transition function, measurement function, state, and additive noise model.

`ckf = trackingCKF(transitionFcn,measurementFcn,state)` specifies the `StateTransitionFcn`, `MeasurementFcn`, and `State` properties directly.

`ckf = trackingCKF(___,Name,Value)` specifies the properties of the Kalman filter using one or more `Name,Value` pair arguments. Any unspecified properties take default values.

Properties

State — Kalman filter state

real-valued M -element vector

Kalman filter state, specified as a real-valued M -element vector.

Example: `[200;0.2;150;0.1;0;0.25]`

Data Types: `double`

StateCovariance — State estimation error covariance

positive-definite real-valued M -by- M matrix

State error covariance, specified as a positive-definite real-valued M -by- M matrix, where M is the size of the filter state. The covariance matrix represents the uncertainty in the filter state.

Example: `eye(6)`

StateTransitionFcn — State transition function

function handle

State transition function, specified as a function handle. This function calculates the state vector at time step k from the state vector at time step $k - 1$. The function can take additional input parameters, such as control inputs or time step size. The function can also include noise values.

The valid syntaxes for the state transition function depend on whether the filter has additive process noise. The table shows the valid syntaxes based on the value of the `HasAdditiveProcessNoise` property.

Valid Syntaxes (HasAdditiveProcessNoise = true)	Valid Syntaxes (HasAdditiveProcessNoise = false)
<code>x(k) = statetransitionfcn(x(k-1))</code> <code>x(k) = statetransitionfcn(x(k-1),parameters)</code> <ul style="list-style-type: none"> $x(k)$ is the state at time k. <code>parameters</code> stands for all additional arguments required by the state transition function. 	<code>x(k) = statetransitionfcn(x(k-1),w(k-1))</code> <code>x(k) = statetransitionfcn(x(k-1),w(k-1),dt)</code> <code>x(k) = statetransitionfcn(__,parameters)</code> <ul style="list-style-type: none"> $x(k)$ is the state at time k. $w(k)$ is a value for the process noise at time k. <code>dt</code> is the time step of the trackingCKF filter, filter, specified in the most recent call to the <code>predict</code> function. The <code>dt</code> argument applies when you use the filter within a tracker and call the <code>predict</code> function with the filter to predict the state of the tracker at the next time step. For the nonadditive process noise case, the tracker assumes that you explicitly specify the time step by using this syntax: <code>predict(filter,dt)</code>. <code>parameters</code> stands for all additional arguments required by the state transition function.

Example: `@constacc`

Data Types: `function_handle`

ProcessNoise — Process noise covariance

1 (default) | positive real-valued scalar | positive-definite real-valued matrix

Process noise covariance:

- When `HasAdditiveProcessNoise` is `true`, specify the process noise covariance as a scalar or a positive-definite real-valued M -by- M matrix. M is the dimension of the state vector. When specified as a scalar, the matrix is a multiple of the M -by- M identity matrix.
- When `HasAdditiveProcessNoise` is `false`, specify the process noise covariance as a Q -by- Q matrix. Q is the size of the process noise vector.

Specify `ProcessNoise` before any call to the `predict` function. In later calls to `predict`, you can optionally specify the process noise as a scalar. In this case, the process noise matrix is a multiple of the Q -by- Q identity matrix.

Example: `[1.0 0.05 0; 0.05 1.0 2.0; 0 2.0 1.0]`

Dependencies

This parameter depends on the `HasAdditiveNoise` property.

HasAdditiveProcessNoise — Model additive process noise

`true` (default) | `false`

Option to model process noise as additive, specified as `true` or `false`. When this property is `true`, process noise is added to the state vector. Otherwise, noise is incorporated into the state transition function.

MeasurementFcn — Measurement model function

function handle

Measurement model function, specified as a function handle. This function can be a nonlinear function that models measurements from the predicted state. Input to the function is the M -element state vector. The output is the N -element measurement vector. The function can take additional input arguments, such as sensor position and orientation.

- If `HasAdditiveMeasurementNoise` is `true`, specify the function using one of these syntaxes:

$$z(k) = \text{measurementfcn}(x(k))$$

$$z(k) = \text{measurementfcn}(x(k), \text{parameters})$$

where $x(k)$ is the state at time k , and $z(k)$ is the predicted measurement at time k . The `parameters` term stands for all additional arguments required by the measurement function.

- If `HasAdditiveMeasurementNoise` is `false`, specify the function using one of these syntaxes:

$$z(k) = \text{measurementfcn}(x(k), v(k))$$

$$z(k) = \text{measurementfcn}(x(k), v(k), \text{parameters})$$

where $x(k)$ is the state at time k , and $v(k)$ is the measurement noise at time k . The `parameters` argument stands for all additional arguments required by the measurement function.

Example: `@cameas`

Data Types: `function_handle`

MeasurementNoise — Measurement noise covariance

1 (default) | positive scalar | positive-definite real-valued matrix

Measurement noise covariance:.

- When `HasAdditiveMeasurementNoise` is `true`, specify the measurement noise covariance as a scalar or an N -by- N matrix. N is the size of the measurement vector. When specified as a scalar, the matrix is a multiple of the N -by- N identity matrix.
- When `HasAdditiveMeasurementNoise` is `false`, specify the measurement noise covariance as an R -by- R matrix. R is the size of the measurement noise vector.

Specify `MeasurementNoise` before any call to the `correct` function. After the first call to `correct`, you can optionally specify the measurement noise as a scalar. In this case, the measurement noise matrix is a multiple of the R -by- R identity matrix.

Example: `0.2`

HasAdditiveMeasurementNoise — Model additive measurement noise

`true` (default) | `false`

Option to enable additive measurement noise, specified as `true` or `false`. When this property is `true`, noise is added to the measurement. Otherwise, noise is incorporated into the measurement function.

HasAdditiveMeasurementNoise — Model additive measurement noise

`true` (default) | `false`

Option to enable additive measurement noise, specified as `true` or `false`. When this property is `true`, noise is added to the measurement. Otherwise, noise is incorporated into the measurement function.

EnableSmoothing — Enable state smoothing

`false` (default) | `true`

Enable state smoothing, specified as `false` or `true`. Setting this property to `true` requires the Sensor Fusion and Tracking Toolbox license. When specified as `true`, you can:

- Use the `smooth` function, provided in Sensor Fusion and Tracking Toolbox, to smooth state estimates in the previous steps. Internally, the filter stores the results from previous steps to allow backward smoothing.
- Specify the maximum number of smoothing steps using the `MaxNumSmoothingSteps` property of the tracking filter.

MaxNumSmoothingSteps — Maximum number of smoothing steps

`5` (default) | positive integer

Maximum number of backward smoothing steps, specified as a positive integer.

Dependencies

To enable this property, set the `EnableSmoothing` property to `true`.

Object Functions

<code>predict</code>	Predict state and state estimation error covariance of tracking filter
<code>correct</code>	Correct state and state estimation error covariance using tracking filter
<code>correctjpd</code>	Correct state and state estimation error covariance using tracking filter and JPDA
<code>distance</code>	Distances between current and predicted measurements of tracking filter
<code>likelihood</code>	Likelihood of measurement from tracking filter
<code>residual</code>	Measurement residual and residual noise from tracking filter
<code>smooth</code>	Backward smooth state estimates of tracking filter
<code>clone</code>	Create duplicate tracking filter

Examples

Run trackingCKF Filter

This example shows how to create and run a `trackingCKF` filter. Call the `predict` and `correct` functions to track an object and correct the state estimation based on measurements.

Create the filter. Specify the constant velocity motion model, the measurement model, and the initial state.

```
state = [0;0;0;0;0;0];  
ckf = trackingCKF(@constvel,@cvmeas,state);
```

Call `predict` to get the predicted state and covariance of the filter. Use a 0.5 second time step.

```
[xPred,pPred] = predict(ckf,0.5);
```

Call `correct` with a given measurement.

```
meas = [1;1;0];  
[xCorr,pCorr] = correct(ckf,meas);
```

Continue to predict the filter state. Specify the desired time step in seconds if necessary.

```
[xPred,pPred] = predict(ckf);           % Predict over 1 second  
[xPred,pPred] = predict(ckf,2);       % Predict over 2 seconds
```

References

[1] Arasaratnam, Ienkaran, and Simon Haykin. "Cubature kalman filters." IEEE Transactions on automatic control 54, no. 6 (2009): 1254-1269.

Extended Capabilities

C/C++ Code Generation

Generate C and C++ code using MATLAB® Coder™.

See Also

Functions

`clone` | `constvel` | `correct` | `cvmeas` | `distance` | `likelihood` | `predict` | `residual`

Objects

`trackingCKF` | `trackingEKF` | `trackingGSF` | `trackingIMM` | `trackingKF` | `trackingMSCEKF` | `trackingPF` | `trackingUKF`

Introduced in R2018b

trackingGSF

Gaussian-sum filter for object tracking

Description

The `trackingGSF` object represents a Gaussian-sum filter designed for object tracking. You can define the state probability density function by a set of finite Gaussian-sum components. Use this filter for tracking objects that require a multi-model description due to incomplete observability of state through measurements. For example, this filter can be used as a range-parameterized extended Kalman filter when the detection contains only angle measurements.

Creation

Syntax

```
gsf = trackingGSF
gsf = trackingGSF(trackingFilters)
gsf = trackingGSF(trackingFilters,modelProbabilities)
gsf = trackingGSF( ____, 'MeasurementNoise', measNoise)
```

Description

`gsf = trackingGSF` returns a Gaussian-sum filter with two constant velocity extended Kalman filters (`trackingEKF`) with equal initial weight.

`gsf = trackingGSF(trackingFilters)` specifies the Gaussian components of the filter in `trackingFilters`. The initial weights of the filters are assumed to be equal.

`gsf = trackingGSF(trackingFilters,modelProbabilities)` specifies the initial weight of the Gaussian components in `modelProbabilities` and sets the `ModelProbabilities` property.

`gsf = trackingGSF(____, 'MeasurementNoise', measNoise)` specifies the measurement noise of the filter. The `MeasurementNoise` property is set for each Gaussian component.

Properties

State — Weighted estimate of filter state

real-valued M -element vector

This property is read-only.

Weighted estimate of filter state, specified as a real-valued M -element vector. This state is estimated based on the weighted combination of filters in `TrackingFilters`. Use `ModelProbabilities` to change the weights.

Example: `[200;0.2]`

Data Types: `single` | `double`

StateCovariance — State estimation error covariancepositive-definite real-valued M -by- M matrix

This property is read-only.

State error covariance, specified as a positive-definite real-valued M -by- M matrix, where M is the size of the filter state. The covariance matrix represents the uncertainty in the filter state. This state covariance is estimated based on the weighted combination of filters in `TrackingFilters`. Use `ModelProbabilities` to change the weights.

Example: `[20 0.1; 0.1 1]`Data Types: `single` | `double`**TrackingFilters — List of filters**`{trackingEKF, trackingEKF}` (default) | cell array of tracking filters

List of filters, specified as a cell array of tracking filters. Specify these filters when creating the object. By default, the filters have equal probability. Specify `modelProbabilities` if the filters have different probabilities.

Note The state of each filter must be the same size and have the same physical meaning.

Data Types: `cell`**ModelProbabilities — Weight of each filter**`[0.5 0.5]` (default) | vector of probabilities between 0 and 1

Weight of each filter, specified as a vector of probabilities from 0 to 1. By default, the weight of each component of the filter is equal.

Data Types: `single` | `double`**MeasurementNoise — Measurement noise covariance**

1 (default) | positive scalar | positive-definite real-valued matrix

Measurement noise covariance, specified as a positive scalar or positive-definite real-valued matrix. The matrix is a square with side lengths equal to the number of measurements. A scalar input is extended to a square diagonal matrix.

Specify `MeasurementNoise` before any call to the `correct` function. After the first call to `correct`, you can optionally specify the measurement noise as a scalar. In this case, the measurement noise matrix is a multiple of the R -by- R identity matrix, where R is the number of measurements.

Example: `0.2`Data Types: `single` | `double`**Object Functions**

<code>predict</code>	Predict state and state estimation error covariance of tracking filter
<code>correct</code>	Correct state and state estimation error covariance using tracking filter
<code>correctjpda</code>	Correct state and state estimation error covariance using tracking filter and JPDA
<code>distance</code>	Distances between current and predicted measurements of tracking filter
<code>likelihood</code>	Likelihood of measurement from tracking filter

clone Create duplicate tracking filter

Examples

Run trackingGSF Filter

This example shows how to create and run a trackingGSF filter. Specify three extended Kalman filters (EKFs) as the components of the Gaussian-sum filter. Call the `predict` and `correct` functions to track an object and correct the state estimate based on measurements.

Create three EKFs each with a state distributed around $[0;0;0;0;0;0]$ and running on position measurements. Specify them as the input to the trackingGSF filter.

```
filters = cell(3,1);
filter{1} = trackingEKF(@constvel,@cvmeas,rand(6,1), 'MeasurementNoise',eye(3));
filter{2} = trackingEKF(@constvel,@cvmeas,rand(6,1), 'MeasurementNoise',eye(3));
filter{3} = trackingEKF(@constvel,@cvmeas,rand(6,1), 'MeasurementNoise',eye(3));
gsf = trackingGSF(filter);
```

Call `predict` to get the predicted state and covariance of the filter. Use a 0.1 sec time step.

```
[x_pred, P_pred] = predict(gsf,0.1);
```

Call `correct` with a given measurement.

```
meas = [0.5;0.2;0.3];
[xCorr,pCorr] = correct(gsf,meas);
```

Compute the distance between the filter and a different measurement.

```
d = distance(gsf,[0;0;0]);
```

References

- [1] Alspach, Daniel, and Harold Sorenson. "Nonlinear Bayesian estimation using Gaussian sum approximations." *IEEE Transactions on Automatic Control*. Vol. 17, No. 4, 1972, pp. 439-448.
- [2] Ristic, B., Arulampalam, S. and McCarthy, J., 2002. *Target motion analysis using range-only measurements: algorithms, performance and application to ISAR data*. Signal Processing, 82(2), pp.273-296.
- [3] Peach, N. "Bearings-only tracking using a set of range-parameterised extended Kalman filters." *IEE Proceedings-Control Theory and Applications* 142, no. 1 (1995): 73-80.

Extended Capabilities

C/C++ Code Generation

Generate C and C++ code using MATLAB® Coder™.

See Also

trackingCKF | trackingEKF | trackingMSCEKF | trackingPF | trackingUKF

Introduced in R2018b

trackingIMM

Interacting multiple model (IMM) filter for object tracking

Description

The `trackingIMM` object represents an interacting multiple model (IMM) filter designed for tracking objects that are highly maneuverable. Use the filter to predict the future location of an object, to reduce noise in the detected location, or help associate multiple object detections with their tracks.

The IMM filter deals with the multiple motion models in the Bayesian framework. This method resolves the target motion uncertainty by using multiple models at a time for a maneuvering target. The IMM algorithm processes all the models simultaneously and switches between models according to their updated weights.

Creation

Syntax

```
imm = trackingIMM
imm = trackingIMM(trackingFilters)
imm = trackingIMM(trackingFilters,modelConversionFcn)
imm = trackingIMM(trackingFilters,modelConversionFcn,transitionProbabilities)
imm = trackingIMM( ___,Name,Value)
```

Description

`imm = trackingIMM` returns an IMM filter object with default tracking filters `{trackingEKF,trackingEKF,trackingEKF}` with the motion models set as constant velocity, constant acceleration, and constant turn, respectively. The filter uses the default conversion function, `@switchimm`.

`imm = trackingIMM(trackingFilters)` specifies the `TrackingFilters` property and sets all other properties to default values.

`imm = trackingIMM(trackingFilters,modelConversionFcn)` also specifies the `ModelConversionFcn` property.

`imm = trackingIMM(trackingFilters,modelConversionFcn,transitionProbabilities)` also specifies the `TransitionProbabilities` property.

`imm = trackingIMM(___,Name,Value)` specifies the properties of the filter using one or more `Name,Value` pair arguments. Any unspecified properties take default values. Specify any other input arguments from previous syntaxes first.

Properties

State — Filter state

`[0;0;0;0;0;0;0]` (default) | real-valued M -element vector

Filter state, specified as a real-valued M -element vector. Specify the initial state when creating the object using name-value pairs.

Data Types: `single` | `double`

StateCovariance — State estimation error covariance

`diag([1 100 1 100 1 100])` (default) | M -by- M matrix | scalar

State error covariance, specified as an M -by- M matrix, where M is the size of the filter state. A scalar input is extended to an M -by- M matrix. The covariance matrix represents the uncertainty in the filter state. Specify the initial state covariance when creating the object using name-value pairs.

Example: `eye(6)`

Data Types: `single` | `double`

TrackingFilters — List of filters

`{trackingEKF, trackingEKF, trackingEKF}` (default) | cell array of tracking filters

List of filters, specified as a cell array of tracking filters. By default, the filters have equal probability. Specify `ModelProbabilities` if the filters have different probabilities.

Data Types: `cell`

ModelConversionFcn — Function to convert state or state covariance

`@switchimm` (default) | function handle

Function to convert the state or state covariance, specified as a function handle. The function converts the state or state covariance from one model type to another. The function signature is:

```
function x2 = modelConversionFcn(modelType1,x1,modelType2)
```

The `modelType1` and `modelType2` inputs are the names of the two model names. `x1` specifies the `State` or `StateCovariance` of the first model. `x2` outputs the `State` or `StateCovariance`

Data Types: `function_handle`

TransitionProbabilities — Probability of filter model transitions

`0.9` (default) | positive real scalar | L -element vector | L -by- L matrix

Probability of filter model transitions, specified as a positive real scalar, L -element vector, or L -by- L matrix, where L is the number of filters:

- When specified as a scalar, the probability is uniform for staying on each filter. The remaining probability $(1-p)$ is distributed evenly across the other motion models.
- When specified as a vector, each element defines the probability of staying on each filter. The remaining probability $(1-p)$ is distributed evenly across the other motion models evenly.
- When specified as a matrix, the (j,k) element defines the probability of transitioning from the j th filter to the k th filter. All elements must lie on the interval $[0,1]$, and each row must sum to 1.

The transition probability defined for each model corresponds to the probability that the filter switches from this model to another model in one second.

Example: `0.75`

Data Types: `single` | `double`

MeasurementNoise — Measurement noise covariance

1 (default) | positive scalar | positive-definite real-valued matrix

Measurement noise covariance, specified as a positive scalar or positive-definite real-valued matrix. When specified as a scalar, the matrix is a multiple of the N -by- N identity matrix. N is the size of the measurement vector.

Specify `MeasurementNoise` before any call to the correct function.

Example: `0.2`

ModelProbabilities — Weight of each filter

1/L*ones(L) (default) | vector of probabilities between 0 and 1

Weight of each filter, specified as a vector of probabilities from 0 to 1. By default, the weight of each component of the filter is equal. L is the number of filters. The IMM filter updates the weight of each filter in the prediction step.

Data Types: `single` | `double`

EnableSmoothing — Enable state smoothing`false` (default) | `true`

Enable state smoothing, specified as `false` or `true`. When specified as `true`, you can

- Use the `smooth` function to smooth the state estimates in the previous time steps.
- Specify the maximum number of smoothing steps using the `MaxNumSmoothingSteps` property of the filter.

Note The smoothing capability is only supported when the `trackingIMM` object is configured with Gaussian filters.

MaxNumSmoothingSteps — Maximum number of smoothing steps

5 (default) | positive integer

Maximum number of backward smoothing steps, specified as a positive integer.

Dependencies

To enable this property, set the `EnableSmoothing` property to `true`.

Object Functions

<code>predict</code>	Predict state and state estimation error covariance of tracking filter
<code>correct</code>	Correct state and state estimation error covariance using tracking filter
<code>correctjpda</code>	Correct state and state estimation error covariance using tracking filter and JPDA
<code>distance</code>	Distances between current and predicted measurements of tracking filter
<code>likelihood</code>	Likelihood of measurement from tracking filter
<code>clone</code>	Create duplicate tracking filter
<code>initialize</code>	Initialize state and covariance of tracking filter
<code>smooth</code>	Backward smooth state estimates of trackingIMM filter

Examples

Run trackingIMM Filter

This example shows how to create and run an interacting multiple model (IMM) filter using a `trackingIMM` object. Call the `predict` and `correct` functions to track an object and correct the state estimate based on measurements.

Create the filter. Use name-value pairs to specify additional properties of the object.

```
detection = objectDetection(0, [1;1;0], 'MeasurementNoise', [1 0.2 0; 0.2 2 0; 0 0 1]);
filter = {initctekf(detection);initcvekf(detection)};
modelConv = @switchimm;
transProb = [0.9,0.9];
imm = trackingIMM('State',[1;1;3;1;5;1;1],'StateCovariance',eye(7),...
    'TransitionProbabilities',transProb,'TrackingFilters',filter,...
    'ModelConversionFcn',modelConv);
```

Call `predict` to get the predicted state and covariance of the filter. Use a 0.5 sec time step.

```
[xPred,pPred] = predict(imm,0.5);
```

Call `correct` with a given measurement.

```
meas = [1;1;0];
[xCorr,pCorr] = correct(imm,meas);
```

Continue to predict the filter state. Specify the desired time step in seconds if necessary.

```
[xPred,pPred] = predict(imm);           % Predict over 1 second
[xPred,pPred] = predict(imm,2);       % Predict over 2 seconds
```

References

- [1] Bar-Shalom, Yaakov, Peter K. Willett, and Xin Tian. *Tracking and data fusion*. Storrs, CT, USA:: YBS publishing, 2011.
- [2] Blackman, Samuel, and Robert Popoli. "*Design and analysis of modern tracking systems*." Norwood, MA: Artech House, 1999.

Extended Capabilities

C/C++ Code Generation

Generate C and C++ code using MATLAB® Coder™.

See Also

`constacc` | `constturn` | `constvel` | `trackingCKF` | `trackingEKF` | `trackingGSF` | `trackingKF` | `trackingUKF`

Introduced in R2018b

smooth

Backward smooth state estimates of trackingIMM filter

Syntax

```
[smoothX,smoothP,modelProbability] = smooth(imm)
[smoothX,smoothP,modelProbability] = smooth(imm,numBackSteps)
```

Description

`[smoothX,smoothP,modelProbability] = smooth(imm)` runs a backward recursion to obtain smoothed states, covariances, and model probabilities at the previous steps for a trackingIMM filter, `imm`. The function determines the number of backward steps based on the number of executed forward steps F and the maximum number of backward steps MB specified by the `MaxNumSmoothingSteps` property of the filter. If $F < MB$, the number of backward steps is $F - 1$. Otherwise, the number of backward steps is MB .

The number of forward steps is equal to the number of calls to the `predict` object function of the filter. The backward steps do not include the current time step of the filter.

`[smoothX,smoothP,modelProbability] = smooth(imm,numBackSteps)` specifies the number of backward smoothing steps `numBackSteps`. The value of `numBackSteps` must be less than or equal to the smaller of $F - 1$ and MB , where F is the number of executed forward steps and MB is the maximum number of backward steps specified by the `MaxNumSmoothingSteps` property of the filter.

Examples

Smoothing for trackingIMM Filter

Generate a truth using the attached `helperGenerateTruth` function. The truth trajectory consists of constant velocity, constant acceleration, and constant turn trajectory segments.

```
n = 1000;
[trueState, time, fig1] = helperGenerateTruth(n);
dt = diff(time(1:2));
numSteps = numel(time);
```

Set up the initial conditions for the simulation.

```
rng(2021); % for repeatable results
positionSelector = [1 0 0 0 0 0;
                   0 0 1 0 0 0;
                   0 0 0 0 1 0]; % Select position from 6-dimentional state [x;vx;y;vy;z;vz]
truePos = positionSelector*trueState;
sigma = 10; % Measurement noise standard deviation
measNoise = sigma* randn(size(truePos));
measPos = truePos + measNoise;
initialState = positionSelector'*measPos(:,1);
initialCovariance = diag([1 1e4 1 1e4 1 1e4]); % Velocity is not measured
```

Construct an IMM filter based on three EKF filters and initialize the IMM filter.

```
detection = objectDetection(0,[0; 0; 0], 'MeasurementNoise', sigma^2 * eye(3));
f1 = initcvekf(detection); % constant velocity EKF
f2 = initcaekf(detection); % constant acceleration EKF
f2.ProcessNoise = 3*eye(3);
f3 = initctekf(detection); % Constant turn EKF
f3.ProcessNoise(3,3) = 100;
imm = trackingIMM({f1; f2; f3}, 'TransitionProbabilities', 0.99, ...
    'ModelConversionFcn', @switchimm, ...
    'EnableSmoothing', true, ...
    'MaxNumSmoothingSteps', size(measPos, 2) - 1);
initialize(imm, initialState, initialCovariance);
```

Preallocate variables for filter outputs.

```
estState = zeros(6, numSteps);
modelProbs = zeros(numel(imm.TrackingFilters), numSteps);
modelProbs(:, 1) = imm.ModelProbabilities;
```

Run the filter.

```
for i = 2:size(measPos, 2)
    predict(imm, dt);
    estState(:, i) = correct(imm, measPos(:, i));
    modelProbs(:, i) = imm.ModelProbabilities;
end
```

Smooth the filter.

```
[smoothState, ~, smoothProbs] = smooth(imm);
```

Visualize the estimates. Zoom in on the figure to view details.

```
fig1
```

```
fig1 =
    Figure (1) with properties:
```

```
    Number: 1
    Name: ''
    Color: [1 1 1]
    Position: [360 502 560 420]
    Units: 'pixels'
```

```
Show all properties
```

```
hold on;
plot3(estState(1,:), estState(3,:), estState(5,:), 'k', 'DisplayName', 'Forward estimates')
plot3(smoothState(1,:), smoothState(3,:), smoothState(5,:), 'g', 'DisplayName', 'Smooth estimates')
axis image;
```

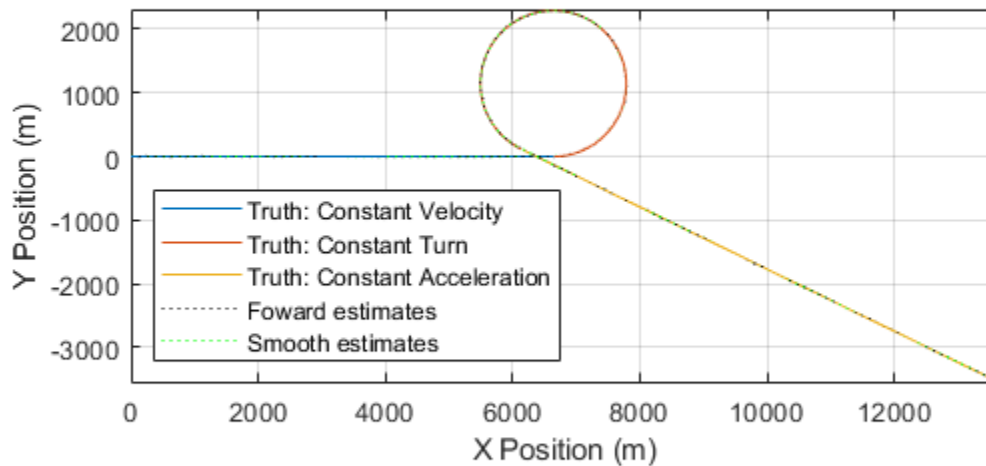

Plot the estimate errors for both the forward estimated states and the smoothed states. From the results, the smoothing process reduces the estimation errors.

```
figure;
errorTruth = abs(estState - trueState);
errorSmooth = abs(smoothState - trueState(:,1:end-1));

subplot(3,1,1)
plot(time,errorTruth(1,:), 'k')
hold on
plot(time(1:end-1),errorSmooth(1,:), 'g')
ylabel('x-error (m)')
legend('Forward estimate error','Smooth error')
title('Absolute Error of Forward and Smooth Estimates')

subplot(3,1,2)
plot(time,errorTruth(2,:), 'k')
hold on;
plot(time(1:end-1),errorSmooth(2,:), 'g')
ylim([0 30])
ylabel('y-error (m)')

subplot(3,1,3)
plot(time,errorTruth(3,:), 'k')
hold on
plot(time(1:end-1),errorSmooth(3,:), 'g')
```

```
xlabel('time (sec)')  
ylabel('z-error (m)')
```

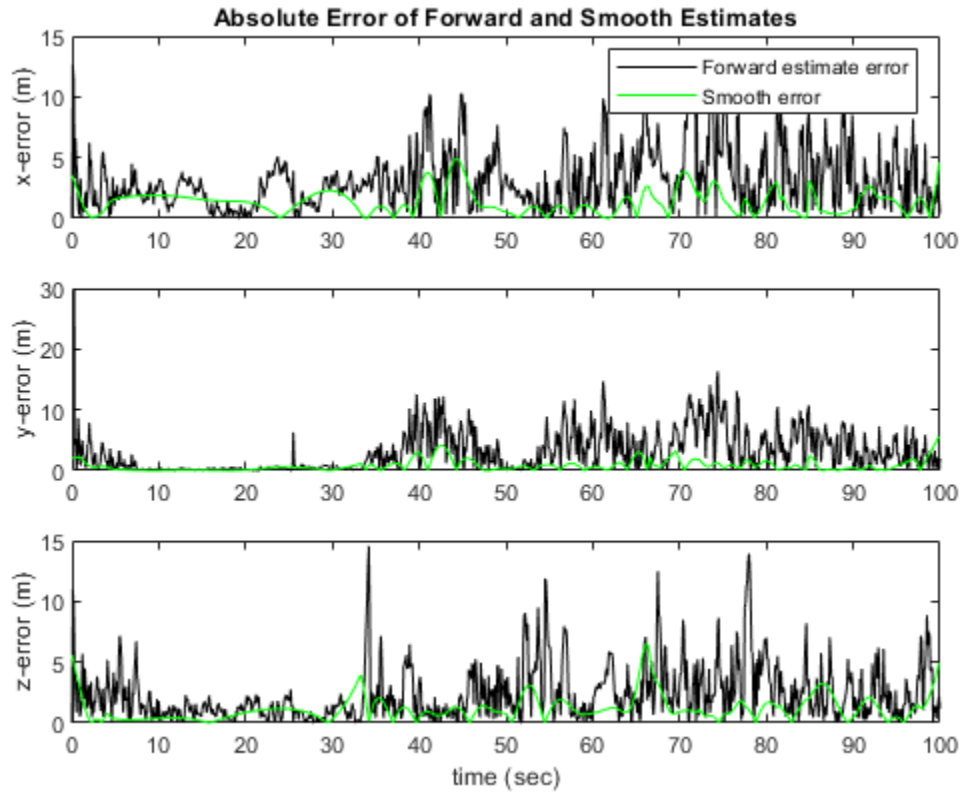

Show the model probabilities based on forward filtering and backward smoothing.

```
figure  
plot(time,modelProbs(1,:))  
hold on  
plot(time,modelProbs(2,:))  
plot(time,modelProbs(3,:))  
xlabel('Time (sec)')  
title('Model Probabilities in Forward Filtering')  
legend('Constant velocity','Constant turn','Constant acceleration')
```

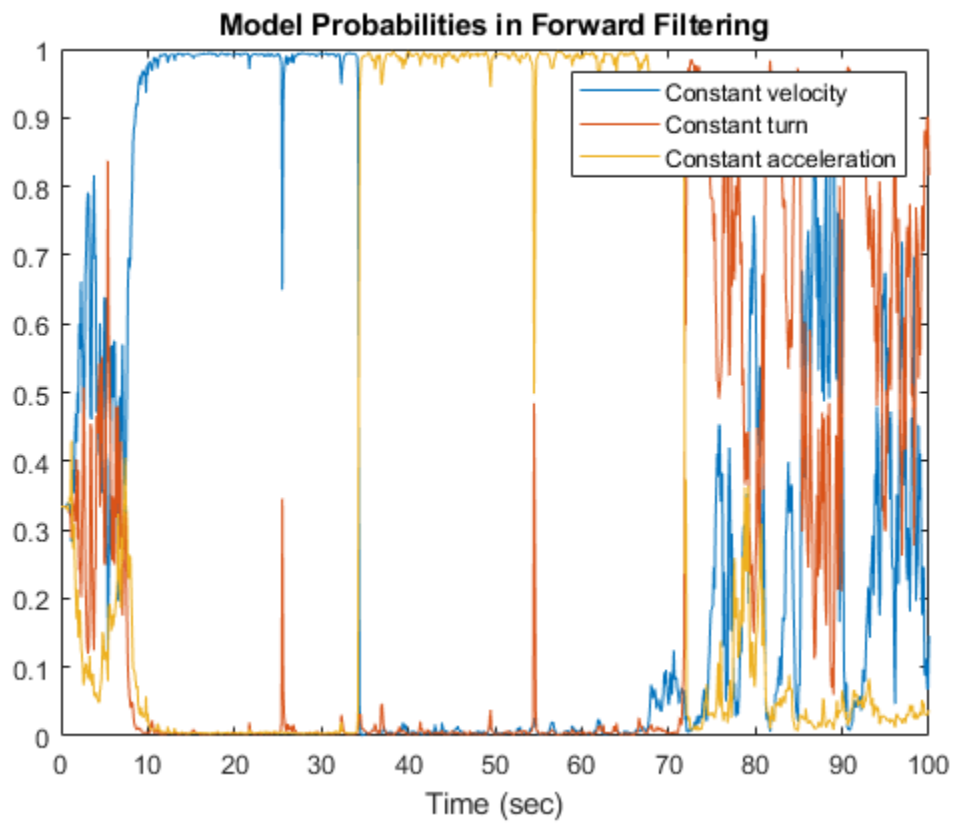

```
figure
plot(time(1:end-1),smoothProbs(1,:))
hold on
plot(time(1:end-1),smoothProbs(2,:))
plot(time(1:end-1),smoothProbs(3,:))
xlabel('Time (sec)');
title('Model Probabilities in Backward Smoothing')
legend('Constant velocity','Constant turn','Constant acceleration')
```

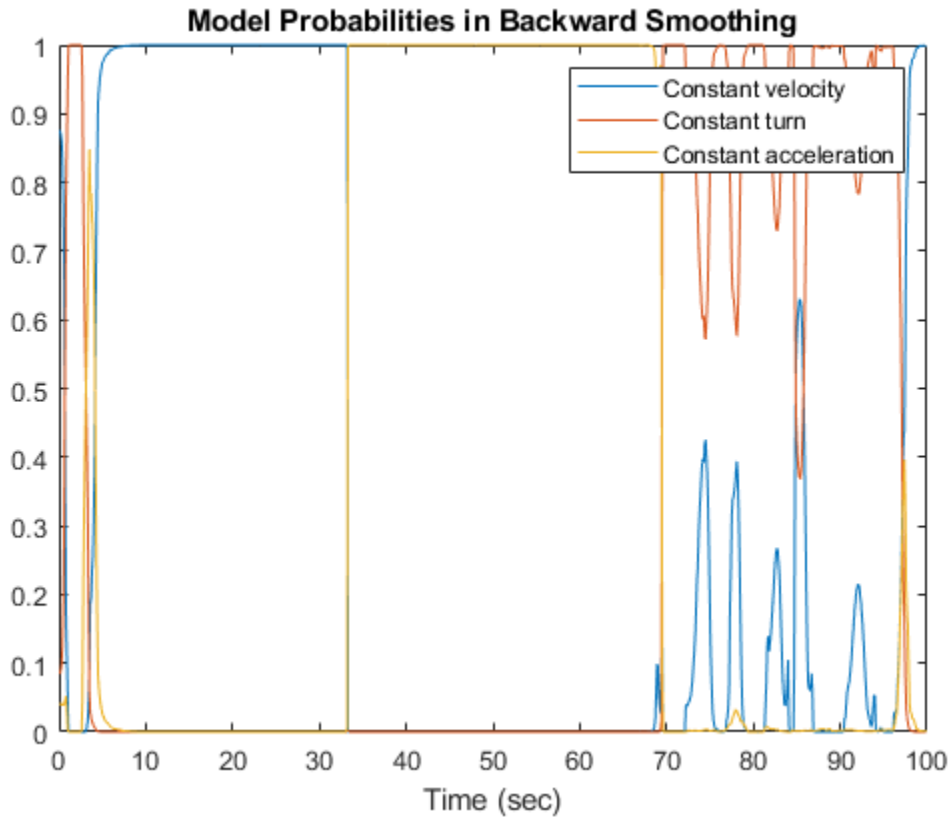

Input Arguments

imm — Interacting multiple model filter

trackingIMM object

Filter for object tracking, specified as an `trackingIMM` object.

numBackSteps — Number of backward steps

positive integer

Number of backward steps, specified as a positive integer. The value must be less than or equal to the smaller of $F - 1$ and MB , where F is the number of executed forward steps and MB is the maximum number of backward steps specified by the `MaxNumSmoothingSteps` property of the filter, `imm`.

Output Arguments

smoothX — Smoothed states

N -by- K matrix

Smoothed states, returned as an N -by- K matrix. N is the state dimension and K is the number of backward steps. The first column represents the state at the end of backward recursion, which is the earliest state in the time interval of smoothing. The last column represents the state at the beginning of backward recursion, which is the latest state in the time interval of smoothing.

Data Types: `single` | `double`

smoothP — Smoothed covariances

N-by-*N*-by-*K* array

Smoothed covariances, returned as an *N*-by-*N*-by-*K* array. *N* is the state dimension and *K* is the number of backward steps. Each page (an *N*-by-*N* matrix) of the array is the smoothed covariance matrix for the corresponding smoothed state in the `smoothX` output.

Data Types: `single` | `double`

modelProbability — Probability of each model

K-by-*M* array of nonnegative scalars

Probability of each model, returned as a *K*-by-*M* array of nonnegative scalars. *K* is the number of backward steps and *M* is the number of models used in the filter.

Data Types: `single` | `double`

References

- [1] Nadarajah, N., R. Tharmarasa, Mike McDonald, and T. Kirubarajan. "IMM Forward Filtering and Backward Smoothing for Maneuvering Target Tracking." *IEEE Transactions on Aerospace and Electronic Systems* 48, no. 3 (July 2012): 2673–78. <https://doi.org/10.1109/TAES.2012.6237617>.

Extended Capabilities

C/C++ Code Generation

Generate C and C++ code using MATLAB® Coder™.

In code generation, after cloning the filter, you cannot change its `EnableSmoothing` property.

See Also

`smooth`(for other tracking filters)

Introduced in R2021a

trackingMSCEKF

Extended Kalman filter for object tracking in modified spherical coordinates (MSC)

Description

The `trackingMSCEKF` object represents an extended Kalman filter (EKF) for object tracking in modified spherical coordinates (MSC) using angle-only measurements from a single observer. Use the filter to predict the future location of an object in the MSC frame or associate multiple object detections with their tracks. You can specify the observer maneuver or acceleration required by the state-transition functions (`@constantvelmsc` and `@constantvelmscjac`) by using the `ObserverInput` property.

The following properties are fixed for the `trackingMSCEKF` object:

- `StateTransitionFcn` - `@constvelmsc`
- `StateTransitionJacobianFcn` - `@constvelmscjac`
- `MeasurementFcn` - `@cvmeasmsc`
- `MeasurementJacobianFcn` - `@cvmeasmscjac`
- `HasAdditiveProcessNoise` - `false`
- `HasAdditiveMeasurementNoise` - `true`

Creation

Syntax

```
mscekf = trackingMSCEKF
mscekf = trackingMSCEKF(Name,Value)
```

Description

`mscekf = trackingMSCEKF` returns an extended Kalman filter to use the MSC state-transition and measurement functions with object trackers. The default `State` implies a static target at 1 meter from the observer at zero azimuth and elevation.

`mscekf = trackingMSCEKF(Name,Value)` specifies the properties of the filter using one or more `Name,Value` pair arguments. Any unspecified properties take default values.

Properties

State — Filter state

`[0;0;0;0;1;0]` (default) | real-valued M -element vector

Filter state, specified as a real-valued M -element vector.

- For 2-D tracking, M is equal to four and the four-dimensional state is: `[az;azRate;1/r;rDot/r]`.

For 3-D tracking, M is equal to six and the six-dimensional state is: `[az;azRate;el;elRate;1/r;rDot/r]`.

`az` and `el` are the azimuth and elevation angle in radians. `azRate` and `elRate` are the azimuth and elevation angular rate in radians per second. `r` is the range in meters, and `rDot` is the range rate in meters per second.

Data Types: `double`

StateCovariance — State estimation error covariance

1 (default) | M -by- M matrix | scalar

State error covariance, specified as an M -by- M matrix where M is the size of the filter state. A scalar input is extended to an M -by- M matrix. The covariance matrix represents the uncertainty in the filter state. M is either 4 for 2-D tracking or 6 for 3-D tracking.

Example: `eye(6)`

StateTransitionFcn — State transition function

@constvelmsc (default)

This property is read-only.

State transition function, specified as a function handle. This function calculates the state vector at time step k from the state vector at time step $k-1$. For the `trackingMSCEKF` object, the transition function is fixed to `@constvelmsc`.

Data Types: `function_handle`

StateTransitionJacobianFcn — State transition function Jacobian

@constvelmscjac (default)

This property is read-only.

The Jacobian of the state transition function, specified as a function handle. This function has the same input arguments as the state transition function. For the `trackingMSCEKF` object, the transition function Jacobian is fixed to `@constvelmscjac`.

Data Types: `function_handle`

ProcessNoise — Process noise covariance

1 (default) | positive real-valued scalar | positive-definite real-valued matrix

Process noise covariance, specified as a Q -by- Q matrix. Q is either 2 or 3. The process noise represents uncertainty in the acceleration of the target.

Specify `ProcessNoise` before any call to the `predict` function. In later calls to `predict`, you can optionally specify the process noise as a scalar. In this case, the process noise matrix is a multiple of the Q -by- Q identity matrix.

Example: `[1.0 0.05; 0.05 2]`

ObserverInput — Acceleration or maneuver of observer

[0;0;0] (default) | $M/2$ -element vector | M -element vector

Acceleration or maneuver of the observer, specified as a three-element vector. To specify an acceleration, use an $M/2$ vector, where M is either 4 for 2-D tracking or 6 for 3-D tracking. To specify a maneuver, give an M -element vector.

Example: [1;2;3]

HasAdditiveProcessNoise — Model additive process noise

false (default)

This property is read-only.

Model additive process noise, specified as false. For the `trackingMSCEKF` object, this property is fixed to false.

MeasurementFcn — Measurement model function

@cvmeasmsc (default)

This property is read-only.

Measurement model function, specified as a function handle, @cvmeasmsc. Input to the function is the M -element state vector. The output is the N -element measurement vector. For the `trackingMSCEKF` object, the measurement model function is fixed to @cvmeasmsc.

Data Types: function_handle

MeasurementJacobianFcn — Jacobian of measurement function

@cvmeasmscjac

This property is read-only.

Jacobian of the measurement function, specified as a function handle. The function has the same input arguments as the measurement function. For the `trackingMSCEKF` object, the Jacobian of the measurement function is fixed to @cvmeasmscjac.

Data Types: function_handle

MeasurementNoise — Measurement noise covariance

1 (default) | positive scalar | positive-definite real-valued matrix

Measurement noise covariance, specified as a positive scalar or positive-definite real-valued matrix. When specified as a scalar, the matrix is a multiple of the N -by- N identity matrix. N is the size of the measurement vector.

Specify `MeasurementNoise` before any call to the correct function.

Example: 0.2

HasAdditiveMeasurementNoise — Model additive measurement noise

true (default)

This property is read-only.

Model additive process noise, specified as true. For the `trackingMSCEKF` object, this property is fixed to true.

EnableSmoothing — Enable state smoothing

false (default) | true

Enable state smoothing, specified as false or true. Setting this property to true requires the Sensor Fusion and Tracking Toolbox license. When specified as true, you can:

- Use the `smooth` function, provided in Sensor Fusion and Tracking Toolbox, to smooth state estimates in the previous steps. Internally, the filter stores the results from previous steps to allow backward smoothing.
- Specify the maximum number of smoothing steps using the `MaxNumSmoothingSteps` property of the tracking filter.

MaxNumSmoothingSteps — Maximum number of smoothing steps

5 (default) | positive integer

Maximum number of backward smoothing steps, specified as a positive integer.

Dependencies

To enable this property, set the `EnableSmoothing` property to `true`.

Object Functions

<code>predict</code>	Predict state and state estimation error covariance of tracking filter
<code>correct</code>	Correct state and state estimation error covariance using tracking filter
<code>correctjpda</code>	Correct state and state estimation error covariance using tracking filter and JPDA
<code>distance</code>	Distances between current and predicted measurements of tracking filter
<code>likelihood</code>	Likelihood of measurement from tracking filter
<code>clone</code>	Create duplicate tracking filter
<code>residual</code>	Measurement residual and residual noise from tracking filter
<code>initialize</code>	Initialize state and covariance of tracking filter
<code>smooth</code>	Backward smooth state estimates of tracking filter

Examples

Create MSC-EKF Tracking Object for 3-D Motion Model

This example shows how to make an extended Kalman filter (EKF) for object tracking in modified spherical coordinates (MSC). Create the filter, predict the state, and correct the state estimate using measurement observations.

Create the filter for a 3-D motion model. Specify the state estimates for the MSC frame.

```
az = 0.1; % in radians
azRate = 0;
r = 1000;
rDot = 10;
el = 0.3; % in radians
elRate = 0;
omega = azRate*cos(el);

mscekf = trackingMSCEKF('State',[az;omega;el;elRate;1/r;rDot/r]);
```

Predict the filter state using a constant observer acceleration.

```
mscekf.ObserverInput = [1;2;3];
predict(mscekf); % Default time 1 second.
predict(mscekf,0.1); % Predict using dt = 0.1 second.
```

Correct the filter state using an angle-only measurement.

```
meas = [5;18]; % measured azimuth and elevation in degrees  
correct(mscekf,meas);
```

References

[1] Aidala, V. and Hammel, S., 1983. *Utilization of modified polar coordinates for bearings-only tracking*. IEEE Transactions on Automatic Control, 28(3), pp.283-294.

See Also

[trackingCKF](#) | [trackingEKF](#) | [trackingGSF](#) | [trackingIMM](#) | [trackingPF](#)

Introduced in R2018b

trackingPF

Particle filter for object tracking

Description

The `trackingPF` object represents an object tracker that follows a nonlinear motion model or that is measured by a nonlinear measurement model. The filter uses a set of discrete particles to approximate the posterior distribution of the state. The particle filter can be applied to arbitrary nonlinear system models. The process and measurement noise can follow an arbitrary non-Gaussian distribution.

The particles are generated using various resampling methods defined by `ResamplingMethod`.

Creation

Syntax

```
pf = trackingPF
pf = trackingPF(transitionFcn,measremntFcn,state)
pf = trackingPF( ____,Name,Value)
```

Description

`pf = trackingPF` returns a `trackingPF` object with state transition function, `@constvel`, measurement function, `@cvmeas`, and a distribution of particles around the state, `[0;0;0;0]`, with unit covariance in each dimension. The filter assumes an additive Gaussian process noise model and Gaussian likelihood calculations.

`pf = trackingPF(transitionFcn,measremntFcn,state)` specifies the `StateTransitionFcn`, `MeasurementFcn`, and `State` properties directly. The filter assumes a unit covariance around the state.

`pf = trackingPF(____,Name,Value)` specifies the properties of the particle filter using one or more `Name,Value` pair arguments. Any unspecified properties take default values.

Properties

State — Current filter state

real-valued M -element vector

This property is read-only.

Current filter state, specified as a real-valued M -element vector. The current state is calculated from `Particles` and `Weight` using the specified `StateEstimationMethod`. M is the `NumStateVariables`. `StateOrientation` determines if the state is given as a row or column vector.

Example: `[0.1;0.05;0.04;-0.01]`

Data Types: `double`

StateCovariance — State estimation error covariance

M -by- M matrix

This property is read-only.

State error covariance, specified as an M -by- M matrix, where M is the size of the filter state. The current state covariance is calculated from `Particles` and `Weight` using the specified `StateEstimationMethod`. M is the `NumStateVariables`. The covariance matrix represents the uncertainty in the filter state.

IsStateVariableCircular — Indicates if state variables have circular distribution

`[0 0 0 0]` (default) | M -element vector of zeros and ones

This property is read-only.

Indicates if state variables have circular distribution, specified as an M -element vector of zeros and ones. Values of 1 indicate it does have a circular distribution. The probability density function of a circular variable takes on angular values in the range $[-\pi, \pi]$.

StateOrientation — Orientation of state vector

'column' (default) | 'row'

Orientation of state vector, specified as 'column' or 'row'.

Note If you set the orientation to 'row', the default `StateTransitionFcn` and `MeasurementFcn` are not supported. All state transition functions and measurement functions provided (`constvel` and `cvmeas`, for example) assume a 'column' orientation.

StateTransitionFcn — State transition function

@`constvel` (default) | function handle

State transition function, specified as a function handle. The state transition function evolves the system state from each particle. The callback function accepts at least one input argument, `prevParticles`, that represents the system at the previous time step. If `StateOrientation` is 'row', the particles are input as a `NumParticles`-by-`NumStateVariables` array. If `StateOrientation` is 'column', the particles are input as a `NumStateVariables`-by-`NumParticles` array.

Additional input arguments can be provided with `varargin`, which are passed to the `predict` function. The function signature is:

```
function predictParticles = stateTransitionFcn(prevParticles,varargin)
```

When the `HasAdditiveProcessNoise` property of the filter is `false`, the state transition function can accept an additional input argument, `dt`. For example:

```
function predictParticles = stateTransitionFcn(prevParticles,dt,varargin)
```

`dt` is the time step of the `trackingPF` filter, `filter`, that was specified in the most recent call to the `predict` function. The `dt` argument applies when you use the filter within a tracker and call the `predict` function with the filter to predict the state of the tracker at the next time step. For the

nonadditive process noise case, the tracker assumes that you explicitly specify the time step by using this syntax: `predict(filter,dt)`

Dependencies

This parameter depends on the `StateOrientation` property.

Data Types: `function_handle`

ProcessNoiseSamplingFcn — Function to generate noise sample for each particle

`@gaussianSampler` (default) | `function handle`

Function to generate noise sample for each particle, specified as a function handle. The function signature is:

```
function noiseSample = processNoiseSamplingFcn(pf)
```

- When `HasAdditiveProcessNoise` is `false`, this function outputs a noise sample as a W -by- N matrix, where W is the number of process noise terms, and N is the number of particles.
- When `HasAdditiveProcessNoise` is `true`, this function outputs a noise sample as an M -by- N matrix, where M is the number of state variables, and N is the number of particles.

To generate a sample from a non-Gaussian distribution, use this property with a custom function handle.

Dependencies

This parameter depends on the `HasAdditiveProcessNoise` property.

Data Types: `function_handle`

ProcessNoise — Process noise covariance

1 (default) | positive real-valued scalar | positive-definite real-valued matrix

Process noise covariance:

- When `HasAdditiveProcessNoise` is `true`, specify the process noise covariance as a scalar or a positive definite real-valued M -by- M matrix. M is the dimension of the state vector. When specified as a scalar, the matrix is a multiple of the M -by- M identity matrix.
- When `HasAdditiveProcessNoise` is `false`, specify the process noise covariance as a Q -by- Q matrix. Q is the size of the process noise vector.

Specify `ProcessNoise` before any call to the `predict` function. In later calls to `predict`, you can optionally specify the process noise as a scalar. In this case, the process noise matrix is a multiple of the Q -by- Q identity matrix.

If `ProcessNoiseSamplingFcn` is specified as `@gaussianSample`, this property defines the Gaussian noise covariance of the process.

Example: `[1.0 0.05; 0.05 2]`

Dependencies

This parameter depends on the `HasAdditiveProcessNoise` property.

HasAdditiveProcessNoise — Model additive process noise

`true` (default) | `false`

Option to model process noise as additive, specified as `true` or `false`. When this property is `true`, process noise is added to the state vector. Otherwise, noise is incorporated into the state transition function.

MeasurementFcn — Measurement model function

@cvmeas (default) | function handle

Measurement model function, specified as a function handle. This function calculates the measurements given the current particles' state. Additional input arguments can be provided with `varargin`. The function signature is:

```
function predictedParticles = measurementFcn(particles,varargin)
```

Data Types: `function_handle`

MeasurementLikelihoodFcn — Callback function calculating the likelihood of sensor measurements

@gaussianLikelihood (default) | function handle

Callback function calculating the likelihood of sensor measurements, specified as a function handle. Once a sensor measurement is available, this callback function calculates the likelihood that the measurement is consistent with the state hypothesis of each particle.

The callback function accepts at least three input arguments, `pf`, `predictedParticles`, and `measurement`. There are two function signatures:

```
function likelihood = measurementLikelihoodFcn(pf,predictedParticles,measurement,varargin)
```

```
function [likelihood,distance] = measurementLikelihoodFcn(pf,predictedParticles,measurement,varargin)
```

`pf` is the particle filter object.

`predictedParticles` represents the set of particles returned from `MeasurementFcn`. If `StateOrientation` is `'row'`, the particles are input as a `NumParticles`-by-`NumStateVariables` array. If `StateOrientation` is `'column'`, the particles are input as a `NumStateVariables`-by-`NumParticles` array.

`measurement` is the state measurement at the current time step.

`varargin` allows you to specify additional inputs to the correct function.

The callback output, `likelihood`, is a vector of length `NumParticles`, which is the likelihood of the given measurement for each particle state hypothesis.

The optional output, `distance`, allows you to specify the distance calculations returned by the `distance` function.

Data Types: `function_handle`

MeasurementNoise — Measurement noise covariance

1 (default) | positive scalar | positive-definite real-valued matrix

Measurement noise covariance, specified as a positive scalar or positive-definite real-valued matrix. When specified as a scalar, the matrix is a multiple of the N -by- N identity matrix. N is the size of the measurement vector.

If `MeasurementLikelihoodFcn` is specified as `@gaussianLikelihood`, this property is used to specify the Gaussian noise covariance of the measurement.

Example: `0.2`

Particles — State hypothesis of each particle

matrix

State hypothesis of each particle, specified as a matrix. If `StateOrientation` is 'row' the particles are a `NumParticles-by-NumStateVariables` array. If `StateOrientation` is 'column', the particles are a `NumStateVariables-by-NumParticles` array.

Each row or column corresponds to the state hypothesis of a single particle.

Data Types: `double`

Weights — Particle weights

`ones(1,NumParticles)` (default) | vector

Particle weights, specified as a vector. The vector is either a row or column vector based on `StateOrientation`. Each row or column is the weight associated with the same row or column in `Particles`.

Data Types: `double`

NumStateVariables — Number of state variables

4 (default) | integer

Number of state variables, specified as an integer. The `State` is comprised of this number of state variables.

NumParticles — Number of particles used

1000 (default) | integer

Number of particles used by the filter, specified as an integer. Each particle represents a state hypothesis.

ResamplingPolicy — Policy settings for triggering resampling

`trackingResamplingPolicy` object

Policy settings for triggering resampling, specified as a `trackingResamplingPolicy` object. The resampling can be triggered either at fixed intervals or dynamically based on the number of effective particles.

ResamplingMethod — Method used for particle resampling

'multinomial' (default) | 'systemic' | 'stratified' | 'residual'

Method used for particle resampling, specified as 'multinomial', 'systemic', 'stratified', or 'residual'.

StateEstimationMethod — Method used for state estimation

'mean' (default) | 'maxweight'

Method used for state estimation, specified as 'mean' or 'maxweight'.

Object Functions

predict	Predict state and state estimation error covariance of tracking filter
correct	Correct state and state estimation error covariance using tracking filter
correctjpda	Correct state and state estimation error covariance using tracking filter and JPDA
distance	Distances between current and predicted measurements of tracking filter
likelihood	Likelihood of measurement from tracking filter
clone	Create duplicate tracking filter
initialize	Initialize state and covariance of tracking filter

Examples

Run trackingPF Filter

This example shows how to create and run a `trackingPF` filter. Call the `predict` and `correct` functions to track an object and correct the state estimate based on measurements.

Create the filter. Specify the initial state and state covariance. Specify the number of particles and that there is additive process noise.

```
state = [0;0;0;0];
stateCov = 10*eye(4);
pf = trackingPF(@constvel,@cvmeas,state,'StateCovariance',stateCov,...
    'NumParticles',2500,'HasAdditiveProcessNoise',true);
```

Call `predict` to get the predicted state and covariance of the filter. Use a 0.5 sec time step.

```
[xPred,pPred] = predict(pf,0.5);
```

You can also modify the particles in the filter to carry a multi-model state hypothesis. Modify the `Particle` property with particles around multiple states after initialization.

```
state1 = [0;0;0;0];
stateCov1 = 10*eye(4);
state2 = [100;0;100;0];
stateCov2 = 10*eye(4);

pf.Particles(:,1:1000) = (state1 + chol(stateCov1)*randn(4,1000));
pf.Particles(:,1001:2000) = (state2 + chol(stateCov2)*randn(4,1000));
```

Call `correct` with a given measurement.

```
meas = [1;1;0];
[xCorr,pCorr] = correct(pf,meas);
```

Continue to predict the filter state. Specify the desired time step in seconds if necessary.

```
[xPred,pPred] = predict(pf);           % Predict over 1 second
[xPred,pPred] = predict(pf,2);       % Predict over 2 seconds
```

References

- [1] Arulampalam, M.S., S. Maskell, N. Gordon, and T. Clapp. "A Tutorial on Particle Filters for Online Nonlinear/Non-Gaussian Bayesian Tracking." *IEEE Transactions on Signal Processing*. Vol. 50, No. 2, Feb 2002, pp. 174-188.

[2] Chen, Z. "Bayesian Filtering: From Kalman Filters to Particle Filters, and Beyond." *Statistics*. Vol. 182, No. 1, 2003, pp. 1-69.

Extended Capabilities

C/C++ Code Generation

Generate C and C++ code using MATLAB® Coder™.

See Also

[constvel](#) | [cvmeas](#) | [trackingCKF](#) | [trackingEKF](#) | [trackingKF](#) | [trackingUKF](#)

Introduced in R2018b

trackScoreLogic

Confirm and delete tracks based on track score

Description

The `trackScoreLogic` object determines if a track should be confirmed or deleted based on the track score (also known as the log likelihood of a track). A track should be confirmed if the current track score is greater than or equal to the confirmation threshold. A track should be deleted if the current track score has decreased relative to the maximum track score by the deletion threshold.

The confirmation and deletion decisions contribute to the track management by a `trackerGNN` or `trackerTOMHT`.

Creation

Syntax

```
logic = trackScoreLogic  
logic = trackScoreLogic(Name, Value, ...)
```

Description

`logic = trackScoreLogic` creates a `trackScoreLogic` object with default confirmation and deletion thresholds.

`logic = trackScoreLogic(Name, Value, ...)` specifies the `ConfirmationThreshold` and `DeletionThreshold` properties of the track score logic object using one or more `Name, Value` pair arguments. Any unspecified properties take default values.

Properties

ConfirmationThreshold — Confirmation threshold

20 (default) | positive scalar

Confirmation threshold, specified as a positive scalar. If the logic score is above this threshold, then the track is confirmed.

Data Types: `single` | `double`

DeletionThreshold — Deletion threshold

-5 (default) | negative scalar

Deletion threshold, specified as a negative scalar. If the value of `Score - MaxScore` is more negative than the deletion threshold, then the track is deleted.

Data Types: `single` | `double`

Score — Current track logic score

numeric scalar

This property is read-only.

Current track logic score, specified as a numeric scalar.

MaxScore — Maximum track logic score

numeric scalar

This property is read-only.

Maximum track logic score, specified as a numeric scalar.

Object Functions

init	Initialize track logic with first hit
hit	Update track logic with subsequent hit
miss	Update track logic with miss
sync	Synchronize scores of trackScoreLogic objects
mergeScores	Update track score by track merging
checkConfirmation	Check if track should be confirmed
checkDeletion	Check if track should be deleted
output	Get current state of track logic
reset	Reset state of track logic
clone	Create copy of track logic

Examples

Create and Update Score-Based Logic

Create a score-based logic. Specify the confirmation threshold as 20 and the deletion threshold as -5.

```
scoreLogic = trackScoreLogic('ConfirmationThreshold',20,'DeletionThreshold',-5)
```

```
scoreLogic =  
    trackScoreLogic with properties:
```

```
    ConfirmationThreshold: 20  
    DeletionThreshold: -5  
    Score: 0  
    MaxScore: 0
```

Specify the probability of detection (**pd**), the probability of false alarm (**pfa**), the volume of a sensor detection bin (**volume**), and the new target rate in a unit volume (**beta**). Initialize the logic using these parameters. The first update to the logic is a hit.

```
pd = 0.9;      % Probability of detection  
pfa = 1e-6;   % Probability of false alarm  
volume = 1;   % Volume of a sensor detection bin  
beta = 0.1;   % New target rate in a unit volume
```

```
init(scoreLogic,volume,beta,pd,pfa);
```

```
disp(['Score and MaxScore: ', num2str(output(scoreLogic))])
```

```
Score and MaxScore: 11.4076      11.4076
```

Update the logic four more times, where only the odd updates register a hit. The score increases with each hit and decreases with each miss. The confirmation flag is `true` whenever the current score is larger than 20.

```
for i = 2:5
    isOdd = logical(mod(i,2));
    if isOdd
        likelihood = 0.05 + 0.05*rand(1);
        hit(scoreLogic,volume,likelihood)
    else
        miss(scoreLogic)
    end

    confFlag = checkConfirmation(scoreLogic);
    delFlag = checkDeletion(scoreLogic);
    disp(['Score and MaxScore: ', num2str(output(scoreLogic)), ...
        '\n Confirmation Flag: ', num2str(confFlag), ...
        '\n Deletion Flag: ', num2str(delFlag)'])
end
```

```
Score and MaxScore: 9.10498      11.4076.  Confirmation Flag: 0. Deletion Flag: 0
Score and MaxScore: 20.4153     20.4153.  Confirmation Flag: 1. Deletion Flag: 0
Score and MaxScore: 18.1127     20.4153.  Confirmation Flag: 0. Deletion Flag: 0
Score and MaxScore: 29.4721     29.4721.  Confirmation Flag: 1. Deletion Flag: 0
```

Update the logic with a miss three times. The deletion flag is `true` by the end of the third miss, because the difference between the current score and maximum score is greater than five.

```
for i = 1:3
    miss(scoreLogic)

    confFlag = checkConfirmation(scoreLogic);
    delFlag = checkDeletion(scoreLogic);
    disp(['Score and MaxScore: ', num2str(output(scoreLogic)), ...
        '\n Confirmation Flag: ', num2str(confFlag), ...
        '\n Deletion Flag: ', num2str(delFlag)])
end
```

```
Score and MaxScore: 27.1695     29.4721.  Confirmation Flag: 1. Deletion Flag: 0
Score and MaxScore: 24.8669     29.4721.  Confirmation Flag: 1. Deletion Flag: 0
Score and MaxScore: 22.5643     29.4721.  Confirmation Flag: 1. Deletion Flag: 1
```

Tips

- If you specify either `ConfirmationThreshold` or `DeletionThreshold` in single precision, then the `trackScoreLogic` object converts the other property to single precision and performs computations in single precision.

References

- [1] Blackman, S., and R. Popoli. *Design and Analysis of Modern Tracking Systems*. Boston, MA: Artech House, 1999.

Extended Capabilities

C/C++ Code Generation

Generate C and C++ code using MATLAB® Coder™.

See Also

`trackHistoryLogic` | `trackerGNN`

Topics

“Introduction to Track Logic”

Introduced in R2018b

mergeScores

Update track score by track merging

Syntax

```
mergeScores(scoreLogic1,scoreLogic2)
```

Description

`mergeScores(scoreLogic1,scoreLogic2)` updates the score of `scoreLogic1` by merging the score with the score of `scoreLogic2`. Score merging increases the score of `scoreLogic1` by $\log(1+\exp(\text{score2}-\text{score1}))$.

Examples

Merge Score Logics

Create a score logic using the default confirmation and deletion thresholds. Initialize the score logic.

```
scoreLogic1 = trackScoreLogic;
volume = 1.3; % Volume of a sensor detection bin
beta1 = 1e-5; % New target rate in a unit volume
init(scoreLogic1,volume,beta1);
disp(['Score and MaxScore of ScoreLogic1: ', num2str(output(scoreLogic1))])
```

```
Score and MaxScore of ScoreLogic1: 2.4596      2.4596
```

Create a copy of the score logic.

```
scoreLogic2 = clone(scoreLogic1);
```

Specify the likelihood that the detection is assigned to the track, the probability of detection (`pd`) and the probability of false alarm (`pfa`). Update the second score logic with a hit.

```
likelihood = 0.05 + 0.05*rand(1);
pd = 0.8;
pfa = 1e-3;
hit(scoreLogic2,volume,likelihood,pd,pfa)
disp(['Score and MaxScore of ScoreLogic2: ', num2str(output(scoreLogic2))])
```

```
Score and MaxScore of ScoreLogic2: 7.0068      7.0068
```

Merge the score of `scoreLogic1` with the score of `scoreLogic2`. The score of `scoreLogic2` is larger, therefore the merged score of `scoreLogic1` increases.

```
mergeScores(scoreLogic1,scoreLogic2)
disp(['Score and MaxScore of merged ScoreLogic1: ', num2str(output(scoreLogic1))])
```

```
Score and MaxScore of merged ScoreLogic1: 7.0173      7.0173
```

Input Arguments

scoreLogic1 — Track score logic to update

`trackScoreLogic` object

Track score logic to update, specified as a `trackScoreLogic` object.

scoreLogic2 — Reference track score logic

`trackScoreLogic` object

Reference track score logic, specified as a `trackScoreLogic` object.

Extended Capabilities

C/C++ Code Generation

Generate C and C++ code using MATLAB® Coder™.

See Also

`clone` | `sync`

Introduced in R2018b

sync

Synchronize scores of `trackScoreLogic` objects

Syntax

```
sync(scoreLogic1,scoreLogic2)
```

Description

`sync(scoreLogic1,scoreLogic2)` sets the values of 'Score on page 2-0' and 'MaxScore on page 2-0' of `scoreLogic1` to the values of `scoreLogic2`.

Examples

Synchronize Track Score Logics

Create a score logic using the default confirmation and deletion thresholds.

```
scoreLogic1 = trackScoreLogic

scoreLogic1 =
    trackScoreLogic with properties:

        ConfirmationThreshold: 20
        DeletionThreshold: -5
        Score: 0
        MaxScore: 0
```

Create a second score logic, specifying the confirmation threshold as 30 and the deletion threshold as -10.

```
scoreLogic2 = trackScoreLogic('ConfirmationThreshold',30,'DeletionThreshold',-10)

scoreLogic2 =
    trackScoreLogic with properties:

        ConfirmationThreshold: 30
        DeletionThreshold: -10
        Score: 0
        MaxScore: 0
```

Initialize the two score logics using different target rates in a unit volume.

```
volume = 1.3; % Volume of a sensor detection bin

beta1 = 0.1; % New target rate in a unit volume
init(scoreLogic1,volume,beta1);
disp(['Score and MaxScore of ScoreLogic1: ', num2str(output(scoreLogic1))])

Score and MaxScore of ScoreLogic1: 11.6699    11.6699
```

```
beta2 = 0.3; % New target rate in a unit volume
init(scoreLogic2,volume,beta2);
disp(['Score and MaxScore of ScoreLogic2: ', num2str(output(scoreLogic2))])
```

```
Score and MaxScore of ScoreLogic2: 12.7685      12.7685
```

Specify the likelihood that a detection is assigned to the track. Then, update the second score logic with a hit.

```
likelihood = 0.05 + 0.05*rand(1);
hit(scoreLogic2,volume,likelihood)
```

```
disp(['Score and MaxScore of ScoreLogic2: ', num2str(output(scoreLogic2))])
```

```
Score and MaxScore of ScoreLogic2: 24.3413      24.3413
```

Synchronize `scoreLogic1` to have the same 'Score' and 'MaxScore' as `scoreLogic2`. The `sync` function does not modify the confirmation or deletion thresholds. To verify this, display the properties of both score logic objects.

```
sync(scoreLogic1,scoreLogic2)
scoreLogic1
```

```
scoreLogic1 =
  trackScoreLogic with properties:
```

```
    ConfirmationThreshold: 20
    DeletionThreshold: -5
           Score: 24.3413
           MaxScore: 24.3413
```

```
scoreLogic2
```

```
scoreLogic2 =
  trackScoreLogic with properties:
```

```
    ConfirmationThreshold: 30
    DeletionThreshold: -10
           Score: 24.3413
           MaxScore: 24.3413
```

Input Arguments

scoreLogic1 — Track score logic to synchronize

`trackScoreLogic` object

Track score logic to synchronize, specified as a `trackScoreLogic` object.

scoreLogic2 — Reference track score logic

`trackScoreLogic` object

Reference track score logic, specified as a `trackScoreLogic` object.

Extended Capabilities

C/C++ Code Generation

Generate C and C++ code using MATLAB® Coder™.

See Also

`clone` | `mergeScores`

Introduced in R2018b

trackHistoryLogic

Confirm and delete tracks based on recent track history

Description

The `trackHistoryLogic` object determines if a track should be confirmed or deleted based on the track history. A track should be confirmed if there are at least M_c hits in the recent N_c updates. A track should be deleted if there are at least M_d misses in the recent N_d updates.

The confirmation and deletion decisions contribute to the track management by a `trackerGNN` object.

Creation

Syntax

```
logic = trackHistoryLogic
logic = trackHistoryLogic(Name, Value, ...)
```

Description

`logic = trackHistoryLogic` creates a `trackHistoryLogic` object with default confirmation and deletion thresholds.

`logic = trackHistoryLogic(Name, Value, ...)` specifies the properties of the track history logic object using one or more `Name, Value` pair arguments. Any unspecified properties take default values.

Properties

ConfirmationThreshold — Confirmation threshold

[2 3] (default) | positive integer scalar | 2-element vector of positive integers

Confirmation threshold, specified as a positive integer scalar or 2-element vector of positive integers. If the logic score is above this threshold, the track is confirmed. `ConfirmationThreshold` has the form $[M_c N_c]$, where M_c is the number of hits required for confirmation in the recent N_c updates. When specified as a scalar, then M_c and N_c have the same value.

Example: [3 5]

Data Types: `single` | `double`

DeletionThreshold — Deletion threshold

[6 6] (default) | positive integer scalar | 2-element vector of positive integers

Deletion threshold, specified as a positive integer scalar or 2-element vector of positive integers. If the logic score is above this threshold, the track is deleted. `DeletionThreshold` has the form $[M_d N_d]$, where M_d is the number of misses required for deletion in the recent N_d updates. When specified as a scalar, then M_d and N_d have the same value.

Example: [5 5]

Data Types: single | double

History — Track history

logical vector

This property is read-only.

Track history, specified as a logical vector of length N , where N is the larger of the second element in the `ConfirmationThreshold` and the second element in the `DeletionThreshold`. The first element is the most recent update. A `true` value indicates a hit and a `false` value indicates a miss.

Object Functions

<code>init</code>	Initialize track logic with first hit
<code>hit</code>	Update track logic with subsequent hit
<code>miss</code>	Update track logic with miss
<code>checkConfirmation</code>	Check if track should be confirmed
<code>checkDeletion</code>	Check if track should be deleted
<code>output</code>	Get current state of track logic
<code>reset</code>	Reset state of track logic
<code>sync</code>	Synchronize trackHistoryLogic objects
<code>clone</code>	Create copy of track logic

Examples

Create and Update History-Based Logic

Create a history-based logic. Specify confirmation threshold values M_c and N_c as the vector [3 5]. Specify deletion threshold values M_d and N_d as the vector [6 7].

```
historyLogic = trackHistoryLogic('ConfirmationThreshold',[3 5], ...
    'DeletionThreshold',[6 7])
```

```
historyLogic =
    trackHistoryLogic with properties:
        ConfirmationThreshold: [3 5]
        DeletionThreshold: [6 7]
        History: [0 0 0 0 0 0 0]
```

Initialize the logic, which records a hit as the first update to the logic.

```
init(historyLogic)
history = historyLogic.History;
disp(['History: ',num2str(history),'.']);
```

```
History: [1 0 0 0 0 0 0].
```

Update the logic four more times, where only the odd updates register a hit. The confirmation flag is `true` by the end of the fifth update, because three hits (M_c) are counted in the most recent five updates (N_c).

```

for i = 2:5
    isOdd = logical(mod(i,2));
    if isOdd
        hit(historyLogic)
    else
        miss(historyLogic)
    end

    history = historyLogic.History;
    confFlag = checkConfirmation(historyLogic);
    delFlag = checkDeletion(historyLogic,true,i);
    disp(['History: ',num2str(history),']. Confirmation Flag: ',num2str(confFlag), ...
        '. Deletion Flag: ',num2str(delFlag)']);
end

History: [0 1 0 0 0 0 0]. Confirmation Flag: 0. Deletion Flag: 0
History: [1 0 1 0 0 0 0]. Confirmation Flag: 0. Deletion Flag: 0
History: [0 1 0 1 0 0 0]. Confirmation Flag: 0. Deletion Flag: 0
History: [1 0 1 0 1 0 0]. Confirmation Flag: 1. Deletion Flag: 0

```

Update the logic with a miss six times. The deletion flag is true by the end of the fifth update, because six misses (Md) are counted in the most recent seven updates (Nd).

```

for i = 1:6
    miss(historyLogic);

    history = historyLogic.History;
    confFlag = checkConfirmation(historyLogic);
    delFlag = checkDeletion(historyLogic);
    disp(['History: ',num2str(history),']. Confirmation Flag: ',num2str(confFlag), ...
        '. Deletion Flag: ',num2str(delFlag)']);
end

History: [0 1 0 1 0 1 0]. Confirmation Flag: 0. Deletion Flag: 0
History: [0 0 1 0 1 0 1]. Confirmation Flag: 0. Deletion Flag: 0
History: [0 0 0 1 0 1 0]. Confirmation Flag: 0. Deletion Flag: 0
History: [0 0 0 0 1 0 1]. Confirmation Flag: 0. Deletion Flag: 0
History: [0 0 0 0 0 1 0]. Confirmation Flag: 0. Deletion Flag: 1
History: [0 0 0 0 0 0 1]. Confirmation Flag: 0. Deletion Flag: 1

```

References

- [1] Blackman, S., and R. Popoli. *Design and Analysis of Modern Tracking Systems*. Boston, MA: Artech House, 1999.

Extended Capabilities

C/C++ Code Generation

Generate C and C++ code using MATLAB® Coder™.

See Also

trackScoreLogic | trackerGNN

Topics

“Introduction to Track Logic”

Introduced in R2018b

checkConfirmation

Check if track should be confirmed

Syntax

```
tf = checkConfirmation(historyLogic)
tf = checkConfirmation(scoreLogic)
```

Description

`tf = checkConfirmation(historyLogic)` returns a flag that is `true` when at least M_c out of N_c recent updates of the track history logic object `historyLogic` are `true`.

`tf = checkConfirmation(scoreLogic)` returns a flag that is `true` when the track should be confirmed based on the track score.

Examples

Check Confirmation of History-Based Logic

Create a history-based logic. Specify confirmation threshold values M_c and N_c as the vector [2 3]. Specify deletion threshold values M_d and N_d as the vector [3 3].

```
historyLogic = trackHistoryLogic('ConfirmationThreshold',[2 3], ...
    'DeletionThreshold',[3 3])
```

```
historyLogic =
    trackHistoryLogic with properties:
```

```
    ConfirmationThreshold: [2 3]
    DeletionThreshold: [3 3]
    History: [0 0 0]
```

Initialize the logic, which records a hit as the first update to the logic. The confirmation flag is `false` because the number of hits is less than two (M_c).

```
init(historyLogic)
history = output(historyLogic);
confFlag = checkConfirmation(historyLogic);
disp(['History: ',num2str(history),']. Confirmation Flag: ',num2str(confFlag)]);
```

```
History: [1 0 0]. Confirmation Flag: 0
```

Update the logic with a hit. The confirmation flag is `true` because two hits (M_c) are counted in the most recent three updates (N_c).

```
hit(historyLogic)
history = output(historyLogic);
confFlag = checkConfirmation(historyLogic);
disp(['History: ',num2str(history),']. Confirmation Flag: ',num2str(confFlag)]);
```

```
History: [1 1 0]. Confirmation Flag: 1
```

Check Confirmation of Score-Based Logic

Create a score-based logic, specifying the confirmation threshold. The logic uses the default deletion threshold.

```
scoreLogic = trackScoreLogic('ConfirmationThreshold',8);
```

Specify the probability of detection (pd), the probability of false alarm (pfa), the volume of a sensor detection bin (volume), and the new target rate in a unit volume (beta).

```
pd = 0.8;  
pfa = 1e-3;  
volume = 1.3;  
beta = 0.1;
```

Initialize the logic using these parameters. The first update to the logic is a hit.

```
init(scoreLogic,volume,beta,pd,pfa);  
disp(['Score and MaxScore: ', num2str(output(scoreLogic))]);
```

```
Score and MaxScore: 4.6444      4.6444
```

The confirmation flag is false because the score is less than the confirmation threshold.

```
confirmationFlag = checkConfirmation(scoreLogic)
```

```
confirmationFlag = logical  
0
```

Specify the likelihood that the detection is assigned to the track. Then, update the logic with a hit. The current score and maximum score increase.

```
likelihood = 0.05 + 0.05*rand(1);  
hit(scoreLogic,volume,likelihood,pd,pfa)  
disp(['Score and MaxScore: ', num2str(output(scoreLogic))])
```

```
Score and MaxScore: 9.1916      9.1916
```

The confirmation flag is now true because the score is greater than the confirmation threshold.

```
confirmationFlag = checkConfirmation(scoreLogic)
```

```
confirmationFlag = logical  
1
```

Input Arguments

historyLogic — Track history logic

```
trackHistoryLogic
```

Track history logic, specified as a `trackHistoryLogic` object.

scoreLogic — Track score logic`trackScoreLogic` object

Track score logic, specified as a `trackScoreLogic` object.

Output Arguments**tf — Track should be confirmed**`true` | `false`

Track should be confirmed, returned as `true` or `false`.

Extended Capabilities**C/C++ Code Generation**

Generate C and C++ code using MATLAB® Coder™.

See Also`trackHistoryLogic` | `trackScoreLogic`**Introduced in R2018b**

checkDeletion

Check if track should be deleted

Syntax

```
tf = checkDeletion(historyLogic)
tf = checkDeletion(historyLogic, tentativeTrack, age)
tf = checkDeletion(scoreLogic)
```

Description

`tf = checkDeletion(historyLogic)` returns a flag that is `true` when at least Md out of Nd recent updates of the track history logic object `historyLogic` are `false`.

`tf = checkDeletion(historyLogic, tentativeTrack, age)` returns a flag that is `true` when the track is tentative and there are not enough detections to allow it to confirm. Use the logical flag `tentativeTrack` to indicate if the track is tentative and provide `age` as a numeric scalar.

`tf = checkDeletion(scoreLogic)` returns a flag that is `true` when the track should be deleted based on the track score.

Examples

Check Deletion of History-Based Logic

Create a history-based logic. Specify confirmation threshold values M_c and N_c as the vector `[2 3]`. Specify deletion threshold values M_d and N_d as the vector `[4 5]`.

```
historyLogic = trackHistoryLogic('ConfirmationThreshold',[2 3], ...
    'DeletionThreshold',[4 5])
```

```
historyLogic =
    trackHistoryLogic with properties:

        ConfirmationThreshold: [2 3]
        DeletionThreshold: [4 5]
        History: [0 0 0 0 0]
```

Initialize the logic, which records a hit as the first update to the logic. The confirmation flag is `false` because the number of hits is less than two (M_c).

```
init(historyLogic)
history = output(historyLogic);
checkConfirmation(historyLogic)
```

```
ans = logical
     0
```

```
delFlag = checkDeletion(historyLogic);
disp(['History: ',num2str(history),']. Deletion Flag: ',num2str(delFlag)]);
```

```
History: [1 0 0 0 0]. Deletion Flag: 1
```

Update the logic with a hit. The confirmation flag is `true` because two hits (M_c) are counted in the most recent three updates (N_c).

```
hit(historyLogic)
history = output(historyLogic);
checkConfirmation(historyLogic)
```

```
ans = logical
     1
```

```
delFlag = checkDeletion(historyLogic);
disp(['History: ',num2str(history),']. Deletion Flag: ',num2str(delFlag)]);
```

```
History: [1 1 0 0 0]. Deletion Flag: 0
```

```
miss(historyLogic)
history = output(historyLogic);
checkConfirmation(historyLogic)
```

```
ans = logical
     1
```

```
delFlag = checkDeletion(historyLogic);
disp(['History: ',num2str(history),']. Deletion Flag: ',num2str(delFlag)]);
```

```
History: [0 1 1 0 0]. Deletion Flag: 0
```

```
miss(historyLogic)
history = output(historyLogic);
delFlag = checkDeletion(historyLogic);
checkConfirmation(historyLogic)
```

```
ans = logical
     0
```

```
disp(['History: ',num2str(history),']. Deletion Flag: ',num2str(delFlag)]);
```

```
History: [0 0 1 1 0]. Deletion Flag: 0
```

Check Deletion of Tentative Track

Create a history-based logic. Specify confirmation threshold values M_c and N_c as the vector [2 3]. Specify deletion threshold values M_d and N_d as the vector [4 5].

```
historyLogic = trackHistoryLogic('ConfirmationThreshold',[2 3], ...
    'DeletionThreshold',5)
```

```
historyLogic =
    trackHistoryLogic with properties:
```

```
ConfirmationThreshold: [2 3]
  DeletionThreshold: [5 5]
    History: [0 0 0 0 0]
```

Initialize the logic, which records a hit as the first update to the logic. Then, record two misses.

```
init(historyLogic)
miss(historyLogic)
miss(historyLogic)
history = output(historyLogic)
```

history = 1x5 logical array

```
0 0 1 0 0
```

The confirmation flag is `false` because the number of hits in the most recent 3 updates (N_c) is less than 2 (M_c).

```
confirmationFlag = checkConfirmation(historyLogic)
```

```
confirmationFlag = logical
0
```

Check the deletion flag as if the track were not tentative. The deletion flag is `false` because the number of misses in the most recent 5 updates (N_m) is less than 4 (M_m).

```
deletionFlag = checkDeletion(historyLogic)
```

```
deletionFlag = logical
0
```

Recheck the deletion flag, treating the track as tentative with an age of 3. The tentative deletion flag is `true` because there are not enough detections to allow the track to confirm.

```
tentativeDeletionFlag = checkDeletion(historyLogic,true,3)
```

```
tentativeDeletionFlag = logical
1
```

Check Deletion of Score-Based Logic

Create a score-based logic, specifying the deletion threshold. The logic uses the default confirmation threshold.

```
scoreLogic = trackScoreLogic('DeletionThreshold',-1);
```

Specify the probability of detection (p_d), the probability of false alarm (p_{fa}), the volume of a sensor detection bin (volume), and the new target rate in a unit volume (β).

```
pd = 0.8;
pfa = 1e-3;
```

```
volume = 1.3;
beta = 0.1;
```

Initialize the logic using these parameters. The first update to the logic is a hit.

```
init(scoreLogic,volume,beta,pd,pfa);
disp(['Score and MaxScore: ', num2str(output(scoreLogic))]);

Score and MaxScore: 4.6444      4.6444
```

Update the logic with a miss. The current score decreases.

```
miss(scoreLogic,pd,pfa)
disp(['Score and MaxScore: ', num2str(output(scoreLogic))])

Score and MaxScore: 3.036      4.6444
```

The deletion flag is `true` because the current score is smaller than the maximum score by more than 1. In other words, `scoreLogic.Score - scoreLogic.MaxScore` is more negative than the deletion threshold, -1.

```
deletionFlag = checkDeletion(scoreLogic)

deletionFlag = logical
              1
```

Input Arguments

historyLogic — Track history logic

`trackHistoryLogic`

Track history logic, specified as a `trackHistoryLogic` object.

tentativeTrack — Track is tentative

`false` | `true`

Track is tentative, specified as `false` or `true`. Use `tentativeTrack` to indicate if the track is tentative.

age — Number of updates

numeric scalar

Number of updates since track initialization, specified as a numeric scalar.

scoreLogic — Track score logic

`trackScoreLogic` object

Track score logic, specified as a `trackScoreLogic` object.

Output Arguments

tf — Track can be deleted

`true` | `false`

Track can be deleted, returned as `true` or `false`.

Extended Capabilities

C/C++ Code Generation

Generate C and C++ code using MATLAB® Coder™.

See Also

`trackHistoryLogic` | `trackScoreLogic`

Introduced in R2018b

clone

Create copy of track logic

Syntax

```
clonedLogic = clone(logic)
```

Description

`clonedLogic = clone(logic)` returns a copy of the current track logic object, `logic`.

Examples

Clone Track History Logic

Create a history-based logic. Specify confirmation threshold values M_c and N_c as the vector [3 5]. Specify deletion threshold values M_d and N_d as the vector [6 7].

```
historyLogic = trackHistoryLogic('ConfirmationThreshold',[3 5], ...
    'DeletionThreshold',[6 7])
```

```
historyLogic =
    trackHistoryLogic with properties:

        ConfirmationThreshold: [3 5]
        DeletionThreshold: [6 7]
        History: [0 0 0 0 0 0 0]
```

Initialize the logic, which records a hit as the first update to the logic.

```
init(historyLogic)
```

Update the logic four more times, where only the odd updates register a hit.

```
for i = 2:5
    isOdd = logical(mod(i,2));
    if isOdd
        hit(historyLogic)
    else
        miss(historyLogic)
    end
end
```

Get the current state of the logic.

```
history = output(historyLogic)
```

```
history = 1x7 logical array
    1    0    1    0    1    0    0
```

Create a copy of the logic. The clone has the same confirmation threshold, deletion threshold, and history as the original history logic.

```
clonedLogic = clone(historyLogic)

clonedLogic =
  trackHistoryLogic with properties:

    ConfirmationThreshold: [3 5]
    DeletionThreshold: [6 7]
    History: [1 0 1 0 1 0 0]
```

Input Arguments

logic — Track logic

trackHistoryLogic object | trackScoreLogic object

Track logic, specified as a trackHistoryLogic object or trackScoreLogic object.

Output Arguments

clonedLogic — Cloned track logic

trackHistoryLogic object | trackScoreLogic object

Cloned track logic, returned as a trackHistoryLogic object or trackScoreLogic object.

Extended Capabilities

C/C++ Code Generation

Generate C and C++ code using MATLAB® Coder™.

See Also

trackHistoryLogic | trackScoreLogic

Introduced in R2018b

hit

Update track logic with subsequent hit

Syntax

```
hit(historyLogic)

hit(scoreLogic, volume, likelihood)
hit(scoreLogic, volume, likelihood, pd, pfa)
```

Description

`hit(historyLogic)` updates the track history with a hit.

`hit(scoreLogic, volume, likelihood)` updates the track score in a case of a hit, given the likelihood of a detection being assigned to the track.

`hit(scoreLogic, volume, likelihood, pd, pfa)` updates the track score in a case of a hit, specifying the probability of detection `pd` and probability of false alarm `pfa`.

Examples

Update History Logic with Hit

Create a history-based logic with the default confirmation and deletion thresholds.

```
historyLogic = trackHistoryLogic;
```

Initialize the logic, which records a hit as the first update to the logic. The first element of the 'History' property, which indicates the most recent update, is 1.

```
init(historyLogic)
history = historyLogic.History;
disp(['History: ', num2str(history), '].']);
```

```
History: [1 0 0 0 0 0].
```

Update the logic with a hit. The first two elements of the 'History' property are 1.

```
hit(historyLogic)
history = historyLogic.History;
disp(['History: ', num2str(history), '].']);
```

```
History: [1 1 0 0 0 0].
```

Update Score Logic with Hit

Create a score-based logic with default confirmation and deletion thresholds.

```
scoreLogic = trackScoreLogic;
```

Specify the probability of detection (`pd`), the probability of false alarm (`pfa`), the volume of a sensor detection bin (`volume`), and the new target rate in a unit volume (`beta`).

```
pd = 0.9;
pfa = 1e-6;
volume = 1.3;
beta = 0.1;
```

Initialize the logic using these parameters. The first update to the logic is a hit.

```
init(scoreLogic,volume,beta,pd,pfa);
disp(['Score and MaxScore: ', num2str(output(scoreLogic))]);
```

```
Score and MaxScore: 11.6699      11.6699
```

Specify the likelihood that the detection is assigned to the track.

```
likelihood = 0.05 + 0.05*rand(1);
```

Update the logic with a hit. The current score and maximum score increase.

```
hit(scoreLogic,volume,likelihood)
disp(['Score and MaxScore: ', num2str(output(scoreLogic))])
```

```
Score and MaxScore: 23.2426      23.2426
```

Input Arguments

historyLogic — Track history logic

`trackHistoryLogic`

Track history logic, specified as a `trackHistoryLogic` object.

scoreLogic — Track score logic

`trackScoreLogic` object

Track score logic, specified as a `trackScoreLogic` object.

volume — Volume of sensor detection bin

nonnegative scalar

Volume of sensor detection bin, specified as a nonnegative scalar. For example, a 2-D radar will have a sensor bin volume of $(\text{azimuth resolution in radians}) * (\text{range}) * (\text{range resolution})$.

Data Types: `single` | `double`

likelihood — Likelihood of a detection being assigned to the track

numeric vector

Likelihood of a detection being assigned to the track, specified as a numeric vector of length m .

Data Types: `single` | `double`

pd — Probability of detection

0.9 (default) | nonnegative scalar

Probability of detection, specified as a nonnegative scalar.

Data Types: `single` | `double`

pfa — Probability of false alarm

1e-6 (default) | nonnegative scalar

Probability of false alarm, specified as a nonnegative scalar.

Data Types: `single` | `double`

Extended Capabilities

C/C++ Code Generation

Generate C and C++ code using MATLAB® Coder™.

See Also

`trackHistoryLogic` | `trackScoreLogic`

Introduced in R2018b

init

Initialize track logic with first hit

Syntax

```
init(historyLogic)

init(scoreLogic, volume, beta)
init(scoreLogic, volume, beta, pd, pfa)
```

Description

`init(historyLogic)` initializes the track history logic with the first hit.

`init(scoreLogic, volume, beta)` initializes the track score logic with the first hit, using default probabilities of detection and false alarm.

`init(scoreLogic, volume, beta, pd, pfa)` initializes the track score logic with the first hit, specifying the probability of detection `pd` and probability of false alarm `pfa`.

Examples

Initialize History-Based Logic

Create a history-based logic with default confirmation and deletion thresholds.

```
historyLogic = trackHistoryLogic

historyLogic =
    trackHistoryLogic with properties:

        ConfirmationThreshold: [2 3]
        DeletionThreshold: [6 6]
        History: [0 0 0 0 0 0]
```

Initialize the logic, which records a hit as the first update to the logic.

```
init(historyLogic)
history = historyLogic.History;
disp(['History: ', num2str(history), '.']);

History: [1 0 0 0 0 0].
```

Initialize Score-Based Logic

Create a score-based logic with default confirmation and deletion thresholds.

```
scoreLogic = trackScoreLogic
```

```
scoreLogic =
  trackScoreLogic with properties:

    ConfirmationThreshold: 20
    DeletionThreshold: -5
    Score: 0
    MaxScore: 0
```

Specify the probability of detection (`pd`), the probability of false alarm (`pfa`), the volume of a sensor detection bin (`volume`), and the new target rate in a unit volume (`beta`).

```
pd = 0.9;
pfa = 1e-6;
volume = 1.3;
beta = 0.1;
```

Initialize the logic using these parameters. The first update to the logic is a hit.

```
init(scoreLogic, volume, beta, pd, pfa);
```

Display the current and maximum score of the logic. Since the logic has been updated once, the current score is equal to the maximum score.

```
currentScore = scoreLogic.Score
currentScore = 11.6699

maximumScore = scoreLogic.MaxScore
maximumScore = 11.6699
```

Input Arguments

historyLogic — Track history logic

`trackHistoryLogic` object

Track history logic, specified as a `trackHistoryLogic` object.

scoreLogic — Track score logic

`trackScoreLogic` object

Track score logic, specified as a `trackScoreLogic` object.

volume — Volume of sensor detection bin

nonnegative scalar

Volume of sensor detection bin, specified as a nonnegative scalar. For example, a 2-D radar will have a sensor bin volume of $(azimuth\ resolution\ in\ radians) * (range) * (range\ resolution)$.

Data Types: `single` | `double`

beta — Rate of new targets in unit volume

nonnegative scalar

Rate of new targets in unit volume, specified as a nonnegative scalar.

Data Types: `single` | `double`

pd — Probability of detection

0.9 (default) | nonnegative scalar

Probability of detection, specified as a nonnegative scalar.

Data Types: `single` | `double`

pfa — Probability of false alarm

1e-6 (default) | nonnegative scalar

Probability of false alarm, specified as a nonnegative scalar.

Data Types: `single` | `double`

Extended Capabilities

C/C++ Code Generation

Generate C and C++ code using MATLAB® Coder™.

See Also

`trackHistoryLogic` | `trackScoreLogic`

Introduced in R2018b

miss

Update track logic with miss

Syntax

```
miss(historyLogic)

miss(scoreLogic)
miss(scoreLogic,pd,pfa)
```

Description

`miss(historyLogic)` updates the track history with a miss.

`miss(scoreLogic)` updates the track score in a case of a miss, using default probabilities of detection and false alarm.

`miss(scoreLogic,pd,pfa)` updates the track score in a case of a miss, specifying the probability of detection `pd` and probability of false alarm `pfa`.

Examples

Update History Logic with Miss

Create a history-based logic with the default confirmation and deletion thresholds.

```
historyLogic = trackHistoryLogic;
```

Initialize the logic, which records a hit as the first update to the logic. The first element of the 'History' property, which indicates the most recent update, is 1.

```
init(historyLogic)
history = historyLogic.History;
disp(['History: ',num2str(history),'.']);
```

```
History: [1 0 0 0 0 0].
```

Update the logic with a miss. The first element of the 'History' property is 0.

```
miss(historyLogic)
history = historyLogic.History;
disp(['History: ',num2str(history),'.']);
```

```
History: [0 1 0 0 0 0].
```

Update Score Logic with Miss

Create a score-based logic with default confirmation and deletion thresholds.

```
scoreLogic = trackScoreLogic;
```

Specify the probability of detection (**pd**), the probability of false alarm (**pfa**), the volume of a sensor detection bin (**volume**), and the new target rate in a unit volume (**beta**).

```
pd = 0.9;  
pfa = 1e-6;  
volume = 1.3;  
beta = 0.1;
```

Initialize the logic using these parameters. The first update to the logic is a hit.

```
init(scoreLogic,volume,beta,pd,pfa);  
disp(['Score and MaxScore: ', num2str(output(scoreLogic))]);
```

```
Score and MaxScore: 11.6699      11.6699
```

Update the logic with a miss. The current score decreases, but the maximum score does not change.

```
miss(scoreLogic,pd,pfa)  
disp(['Score and MaxScore: ', num2str(output(scoreLogic))])
```

```
Score and MaxScore: 9.36735      11.6699
```

Input Arguments

historyLogic — Track history logic

`trackHistoryLogic`

Track history logic, specified as a `trackHistoryLogic` object.

scoreLogic — Track score logic

`trackScoreLogic` object

Track score logic, specified as a `trackScoreLogic` object.

pd — Probability of detection

0.9 (default) | nonnegative scalar

Probability of detection, specified as a nonnegative scalar.

Data Types: `single` | `double`

pfa — Probability of false alarm

1e-6 (default) | nonnegative scalar

Probability of false alarm, specified as a nonnegative scalar.

Data Types: `single` | `double`

Extended Capabilities

C/C++ Code Generation

Generate C and C++ code using MATLAB® Coder™.

See Also

`trackHistoryLogic` | `trackScoreLogic`

Introduced in R2018b

output

Get current state of track logic

Syntax

```
history = output(historyLogic)
scores = output(scoreLogic)
```

Description

`history = output(historyLogic)` returns the recent history updates of the track history logic object, `historyLogic`.

`scores = output(scoreLogic)` returns in `scores` the current score and maximum score of track score logic object, `scoreLogic`.

Examples

Get Recent History of History-Based Logic

Create a history-based logic. Specify confirmation threshold values M_c and N_c as the vector [3 5]. Specify deletion threshold values M_d and N_d as the vector [6 7].

```
historyLogic = trackHistoryLogic('ConfirmationThreshold',[3 5], ...
    'DeletionThreshold',[6 7]);
```

Get the recent history of the logic. The history vector has a length of 7, which is the greater of N_c and N_d . All values are 0 because the logic is not initialized.

```
h = output(historyLogic)
h = 1x7 logical array
    0    0    0    0    0    0    0
```

Initialize the logic, then get the recent history of the logic. The first element, which indicates the most recent update, is 1.

```
init(historyLogic);
h = output(historyLogic)
h = 1x7 logical array
    1    0    0    0    0    0    0
```

Update the logic with a hit, then get the recent history of the logic.

```
hit(historyLogic);
h = output(historyLogic)
```

```
h = 1x7 logical array
    1    1    0    0    0    0    0
```

Get Current Score of Score-Based Logic

Create a score-based logic with default confirmation and deletion thresholds.

```
scoreLogic = trackScoreLogic;
```

Get the current and maximum score of the logic. Both scores are 0 because the logic is not initialized.

```
s = output(scoreLogic)
```

```
s = 1x2
    0    0
```

Specify the volume of a sensor detection bin (*volume*), and the new target rate in a unit volume (*beta*). Initialize the logic using these parameters and the default probabilities of detection and false alarm. The first update to the logic is a hit.

```
volume = 1.3;
beta = 0.1;
init(scoreLogic,volume,beta);
```

Get the current and maximum score of the logic.

```
s = output(scoreLogic)
```

```
s = 1x2
  11.6699  11.6699
```

Update the logic with a miss, then get the updated scores.

```
miss(scoreLogic)
s = output(scoreLogic)
```

```
s = 1x2
  9.3673  11.6699
```

Input Arguments

historyLogic — Track history logic

```
trackHistoryLogic
```

Track history logic, specified as a `trackHistoryLogic` object.

scoreLogic — Track score logic`trackScoreLogic` object

Track score logic, specified as a `trackScoreLogic` object.

Output Arguments**history — Recent history**

logical vector

Recent track history of `historyLogic`, returned as a logical vector. The length of the vector is the same as the length of the `History` property of the `historyLogic`. The first element is the most recent update. A `true` value indicates a hit and a `false` value indicates a miss.

scores — Current and maximum scores

1-by-2 numeric vector

Current and maximum scores of `scoreLogic`, returned as a 1-by-2 numeric vector. The first element specifies the current score. The second element specifies the maximum score.

Extended Capabilities**C/C++ Code Generation**

Generate C and C++ code using MATLAB® Coder™.

See Also`trackHistoryLogic` | `trackScoreLogic`**Introduced in R2018b**

reset

Reset state of track logic

Syntax

```
reset(logic)
```

Description

`reset(logic)` resets the track logic object, `logic`.

Examples

Reset Track History Logic

Create a history-based logic using the default confirmation threshold and deletion threshold. Get the current state of the logic. The current and maximum score are both 0.

```
historyLogic = trackHistoryLogic;
history = output(historyLogic)
```

history = 1x6 logical array

```
0 0 0 0 0 0
```

Initialize the logic, then get the current state of the logic.

```
volume = 1.3;
beta = 0.1;
init(historyLogic);
history = output(historyLogic)
```

history = 1x6 logical array

```
1 0 0 0 0 0
```

Reset the logic, then get the current state of the logic.

```
reset(historyLogic)
history = output(historyLogic)
```

history = 1x6 logical array

```
0 0 0 0 0 0
```

Reset Track Score Logic

Create a score-based logic using the default confirmation threshold and deletion threshold. Get the current state of the logic. The current and maximum score are both 0.

```
scoreLogic = trackScoreLogic;  
score = output(scoreLogic)
```

```
score = 1×2  
      0      0
```

Initialize the logic, then get the current state of the logic.

```
volume = 1.3;  
beta = 0.1;  
init(scoreLogic,volume,beta);  
score = output(scoreLogic)
```

```
score = 1×2  
  11.6699  11.6699
```

Reset the logic, then get the current state of the logic. The current and maximum score are both 0.

```
reset(scoreLogic)  
score = output(scoreLogic)
```

```
score = 1×2  
      0      0
```

Input Arguments

Logic — Track logic

trackHistoryLogic object | trackScoreLogic object

Track logic, specified as a trackHistoryLogic object or trackScoreLogic object.

Extended Capabilities

C/C++ Code Generation

Generate C and C++ code using MATLAB® Coder™.

See Also

trackHistoryLogic | trackScoreLogic

Introduced in R2018b

sync

Synchronize trackHistoryLogic objects

Syntax

```
sync(historyLogic1,historyLogic2)
```

Description

sync(historyLogic1,historyLogic2) synchronizes historyLogic1 based on historyLogic2 so that they have the same history value.

Examples

Synchronize Two trackHistoryLogic Objects

Create two trackHistoryLogic objects.

```
logic1 = trackHistoryLogic
```

```
logic1 =
  trackHistoryLogic with properties:
    ConfirmationThreshold: [2 3]
    DeletionThreshold: [6 6]
    History: [0 0 0 0 0 0]
```

```
logic2 = trackHistoryLogic('ConfirmationThreshold',[3 3],'DeletionThreshold',[5 6])
```

```
logic2 =
  trackHistoryLogic with properties:
    ConfirmationThreshold: [3 3]
    DeletionThreshold: [5 6]
    History: [0 0 0 0 0 0]
```

Initialize logic2 with a hit.

```
init(logic2)
logic2

logic2 =
  trackHistoryLogic with properties:
    ConfirmationThreshold: [3 3]
    DeletionThreshold: [5 6]
    History: [1 0 0 0 0 0]
```

Synchronize logic1 to logic2.

```
sync(logic1,logic2);
logic1

logic1 =
  trackHistoryLogic with properties:

    ConfirmationThreshold: [2 3]
    DeletionThreshold: [6 6]
    History: [1 0 0 0 0 0]
```

Input Arguments

historyLogic1 — Track history logic

trackHistoryLogic object

Track history logic, specified as a trackHistoryLogic object.

historyLogic2 — Track history logic

trackHistoryLogic object

Track history logic, specified as a trackHistoryLogic object.

Introduced in R2021a

System Objects

adsbReceiver

Automatic Dependent Surveillance-Broadcast (ADS-B) receiver

Description

The `adsbReceiver` System object models an Automatic Dependent Surveillance-Broadcast (ADS-B) receiver. You can use this object to receive ADS-B messages generated by the `adsbTransponder` System object and output tracks.

To generate ADS-B tracks:

- 1 Create the `adsbReceiver` object and set its properties.
- 2 Call the object with arguments, as if it were a function.

To learn more about how System objects work, see [What Are System Objects?](#).

Creation

Syntax

```
receiver = adsbReceiver  
receiver = adsbReceiver(Name,Value)
```

Description

`receiver = adsbReceiver` creates an ADS-B receiver System object, `receiver`, with default property values.

`receiver = adsbReceiver(Name,Value)` sets “Properties” on page 3-2 for the transponder using one or more name-value pairs. For example, `adsbReceiver('ReceiverIndex',1)` creates an ADS-B receiver that has a unique identifier of 1.

Properties

Unless otherwise indicated, properties are *nontunable*, which means you cannot change their values after calling the object. Objects lock when you call them, and the `release` function unlocks them.

If a property is *tunable*, you can change its value at any time.

For more information on changing property values, see [System Design in MATLAB Using System Objects](#).

ReceiverIndex — Unique identifier of receiver

0 (default) | nonnegative integer

Unique identifier of the receiver, specified as a nonnegative integer.

MaxNumTracks — Maximum number of tracks

100 (default) | nonnegative integer

Maximum number of tracks that the ADS-B receiver can maintain, specified as a positive integer.

NumTracks — Number of tracks

0 (default) | nonnegative integer

This property is read-only.

Number of tracks maintained in the ADS-B receiver, specified as a nonnegative integer.

Usage**Syntax**

```
tracks = receiver(messages,time)
[tracks,incomplete] = receiver(messages,time)
[tracks,incomplete,info] = receiver(messages,time)
```

Description

`tracks = receiver(messages,time)` updates the receiver with a list of ADS-B messages to the time of reception. Each message can generate at most one track. If the information contained in a message does not constitute a full track state, the receiver does not output tracks based on this message.

`[tracks,incomplete] = receiver(messages,time)` additionally returns the list of messages from which the receiver cannot derive a full track state.

`[tracks,incomplete,info] = receiver(messages,time)` additionally returns the analysis information for the input messages.

Input Arguments**messages — ADS-B messages**

array of ADS-B message structures

ADS-B messages, specified as an array of ADS-B message structures. Each structure contains these fields:

ADS-B Message Structure

Field Name	Description	Default Value
ICAO	International Civil Aviation Organization address, specified as a six-element character vector or a six-character string scalar.	six-element empty character vector
Time	The ADS-B transponder broadcasting time, specified as a scalar. If the transponder is not synchronized with a reliable time source, use NaN as the value of Time so that the reception time will be used in the receiver for the message.	NaN
Category	Category of the transponder platform, specified as an <code>adsbCategory</code> enumeration object.	<code>adsbCategory(0)</code>
Callsign	Call sign of the transponder platform, specified as an eight-element character vector or an eight-character string.	eight-element empty character vector
Latitude	Reported latitude of the broadcasting transponder, specified as a scalar between -90 and 90 in degrees. Use NaN when no information is available.	NaN
Longitude	Reported longitude of the broadcasting transponder, specified as a scalar between -180 and 180 in degrees. Use NaN when no information is available.	NaN
Altitude	Reported altitude of the broadcasting transponder, specified as a scalar in meters. It represents the height above the WG84 ellipsoid. Use NaN when no information is available.	NaN
Veast	Reported velocity component in the east direction, specified as a scalar in meters per second. The positive direction for this component is the east direction. Use NaN when no information is available.	NaN
Vnorth	Reported velocity component in the north direction, specified as a scalar in meters per second. The positive direction for this component is the north direction. Use NaN when no information is available.	NaN
ClimbRate	Reported climb rate, specified as a scalar in meters per second. The positive direction for this component is the upward direction. Use NaN when no information is available.	NaN

Field Name	Description	Default Value
Heading	Reported heading direction, specified as a scalar between 0 and 360 in degrees. The heading direction angle is north at 0 and is clockwise-positive. Use NaN when no information is available.	NaN
NACPosition	<p>Navigation Accuracy Category of position, specified as an integer from 0 to 11. Each integer value defines an Estimated Position Uncertainty (EPU) bound. EPU bound is a 95% accuracy bound for the horizontal position. The bound defines a circle centered on the reported position so that the probability of the actual position lying inside the circle is 0.95. The list shows the relation between the integer and the bound:</p> <ul style="list-style-type: none"> • 0: EPU \geq 18.52 km (10 NM) or unknown • 1: EPU < 18.52 km (10 NM) • 2: EPU < 7.408 (4 NM) • 3: EPU < 3.704 (2 NM) • 4: EPU < 1852 m (1 NM) • 5: EPU < 926 m (0.5 NM) • 6: EPU < 555.6 m (0.3 NM) • 7: EPU < 185.2 m (0.1 NM) • 8: EPU < 92.6 m (0.05 NM) • 9: EPU < 30 m • 10: EPU < 10 m • 11: EPU < 3 m <p>where NM represents nautical miles.</p>	0
GeometricVertical Accuracy	<p>Geometric Vertical Accuracy (GVA) of altitude, specified as an integer from 0 to 2. Each integer value represents a 95% accuracy bound on the reported altitude. The list shows the relation between the integer and the bound:</p> <ul style="list-style-type: none"> • 0: GVA > 150 m or unknown • 1: GVA \leq 150 m • 2: GVA < 45 m 	0

Field Name	Description	Default Value
NACVelocity	<p>Navigation Accuracy Category of velocity, specified as an integer from 0 to 4. Each integer represents a 95% accuracy bound on the reported Horizontal Velocity Error (HVE). The list shows the relation between the integer and the bound:</p> <ul style="list-style-type: none"> • 0: HVE \geq 10 m/s or unknown • 1: HVE < 10 m/s • 2: HVE < 3 m/s • 3: HVE < 1 m/s • 4: HVE < 0.3 m/s 	0

time — Time of message reception

nonnegative scalar

Time of message reception, specified as a nonnegative scalar in seconds.

Output Arguments

tracks — Tracks generated from messages

array of objectTrack objects

Tracks generated from messages, returned as an array of objectTrack objects.

incomplete — Incomplete messages

array of ADS-B message structures

Incomplete messages, returned as an array of ADS-B message structures. Incomplete messages are the messages that the tracker did not successfully use to generate tracks.

info — Analysis information

structure

Analysis information, returned as a structure. The structure contains these fields:

Field Name	Description
Discarded	Discarded message ICAO indices, returned as an array of positive integers. Each integer represents the corresponding array index of a discarded message structure in the messages input.

Field Name	Description
IcaoToTrackID	<p>Mapping of ICAO addresses to track IDs, returned as a <i>K</i>-element array of structures. Each structure contains two fields:</p> <ul style="list-style-type: none"> • ICAO — ICAO address of the message, returned as a six-element character vector. • TrackID — Track ID, returned as a positive integer.

Object Functions

To use an object function, specify the System object as the first input argument. For example, to release system resources of a System object named `obj`, use this syntax:

```
release(obj)
```

Specific to adsbReceiver

`deleteTrack` Delete track managed by `adsbReceiver`

Common to All System Objects

`step` Run System object algorithm
`release` Release resources and allow changes to System object property values and input characteristics
`isLocked` Determine if System object is in use
`clone` Create duplicate System object
`reset` Reset internal states of System object

Examples

Create ADS-B Receiver and Generate Tracks

Create an ADS-B receiver.

```
receiver = adsbReceiver;
```

Define an ADS-B message generated from the AAF123 transponder. Assume the transponder is not synchronized from UTC by setting `Time` to `NaN`.

```
airbornePositionMessage = struct('ICAO','AAF123','Time', NaN,...
    'Latitude',70, 'Longitude',30, 'Altitude',2000);
```

Define the time of message receipt.

```
t0 = 0;
```

Call the receiver to generate tracks. Since the velocity information is not available in the message, the receiver cannot derive a valid track.

```
[tracks,incomplete,info] = receiver(airbornePositionMessage,t0)
```

```
tracks =  
  
    1x0 objectTrack array with properties:  
  
        TrackID  
        BranchID  
        SourceIndex  
        UpdateTime  
        Age  
        State  
        StateCovariance  
        StateParameters  
        ObjectClassID  
        TrackLogic  
        TrackLogicState  
        IsConfirmed  
        IsCoasted  
        IsSelfReported  
        ObjectAttributes  
  
incomplete = struct with fields:  
    ICAO: 'AAF123'  
    Time: 0  
    Category: No_Category_Information  
    Callsign: '  
    Latitude: 70  
    Longitude: 30  
    Altitude: 2000  
    Veast: NaN  
    Vnorth: NaN  
    ClimbRate: NaN  
    Heading: NaN  
    NACPosition: 0  
    GeometricVerticalAccuracy: 0  
    NACVelocity: 0  
    Age: 1  
  
info = struct with fields:  
    Discarded: [1x0 uint32]  
    IcaoToTrackID: [1x1 struct]
```

Create a new ADS-B message from the same transponder, which contains the velocity information. The time of receipt is at 1 second.

```
airborneVelocityMessage = struct('ICAO','AAF123','Time',NaN, ...  
    'Vnorth',250,'Veast',0,'ClimbRate',-1);  
t1 = 1;
```

Add the new message to the receiver. The receiver can now format the combination of the two messages into a track.

```
[tracks,incomplete,info] = receiver(airborneVelocityMessage,t1)
```

```
tracks =  
    objectTrack with properties:
```

```
        TrackID: 1
```

```

        BranchID: 0
        SourceIndex: 0
        UpdateTime: 1
        Age: 2
        State: [6x1 double]
        StateCovariance: [6x6 double]
        StateParameters: [1x1 struct]
        ObjectClassID: 0
        TrackLogic: 'History'
        TrackLogicState: 1
        IsConfirmed: 1
        IsCoasted: 0
        IsSelfReported: 1
        ObjectAttributes: [1x1 struct]

```

incomplete =

1x0 empty struct array with fields:

```

    ICAO
    Time
    Category
    Callsign
    Latitude
    Longitude
    Altitude
    Veast
    Vnorth
    ClimbRate
    Heading
    NACPosition
    GeometricVerticalAccuracy
    NACVelocity
    Age

```

info = struct with fields:

```

    Discarded: [1x0 uint32]
    IcaoToTrackID: [1x1 struct]

```

Extended Capabilities

C/C++ Code Generation

Generate C and C++ code using MATLAB® Coder™.

Usage notes and limitations:

See “System Objects in MATLAB Code Generation” (MATLAB Coder).

See Also

adsbCategory | adsbTransponder

Introduced in R2021a

deleteTrack

Delete track managed by `adsbReceiver`

Syntax

```
deleted = deleteTrack(receiver, ID)
```

Description

`deleted = deleteTrack(receiver, ID)` deletes the track specified by `ID` in the ADS-B receiver object, `receiver`. You must update the ADS-B receiver object at least once before you are able to delete an ADS-B track.

Examples

Delete Track From `adsbReceiver`

Create an ADS-B receiver.

```
receiver = adsbReceiver;
```

Define ADS-B messages generated from transponder AAF123.

```
airbornePositionMessage = struct('ICAO', 'AAF123', 'Time', NaN, ...  
    'Latitude', 70, 'Longitude', 30, 'Altitude', 2000, ...  
    'Vnorth', 250, 'Veast', 0, 'ClimbRate', -1);
```

Call the receiver to generate tracks.

```
tracks = receiver(airbornePositionMessage, 0)
```

```
tracks =
```

```
    objectTrack with properties:
```

```
        TrackID: 1  
        BranchID: 0  
        SourceIndex: 0  
        UpdateTime: 0  
        Age: 1  
        State: [6x1 double]  
        StateCovariance: [6x6 double]  
        StateParameters: [1x1 struct]  
        ObjectClassID: 0  
        TrackLogic: 'History'  
        TrackLogicState: 1  
        IsConfirmed: 1  
        IsCoasted: 0  
        IsSelfReported: 1  
        ObjectAttributes: [1x1 struct]
```

Delete the track.

```
tf = deleteTrack(receiver,1)
```

```
tf = logical  
    1
```

Input Arguments

receiver — ADS-B receiver

adsbReceiver object

ADS-B receiver, specified as an adsbReceiver object.

ID — Track identifier

positive integer | six-element character vector | six-character string scalar

Track identifier, specified as a track ID or an International Civil Aviation Organization (ICAO) ID. The track ID is an integer, where as an ICAO ID is a six-element character vector or a six-character string.

Output Arguments

deleted — Track deletion indicator

1 | 0

Track deletion indicator, returned as 1 or 0. If the track specified by the ID input existed and was successfully deleted, this argument returns as 1. If the track did not exist, a warning is issued and this argument returns as 0.

Extended Capabilities

C/C++ Code Generation

Generate C and C++ code using MATLAB® Coder™.

See Also

adsbReceiver | adsbTransponder

Introduced in R2021a

adsbTransponder

Automatic Dependent Surveillance-Broadcast (ADS-B) transponder

Description

The `adsbTransponder` System object models an Automatic Dependent Surveillance-Broadcast (ADS-B) transponder. You can use the object to generate ADS-B messages and receive the messages using an `adsbReceiver` System object.

To generate ADS-B messages:

- 1 Create the `adsbTransponder` object and set its properties.
- 2 Call the object with arguments, as if it were a function.

To learn more about how System objects work, see [What Are System Objects?](#).

Creation

Syntax

```
transponder = adsbTransponder(ICA0)  
transponder = adsbTransponder(ICA0,Name,Value)
```

Description

`transponder = adsbTransponder(ICA0)` creates an ADS-B transponder with a unique International Civil Aviation Organization (ICAO) address that generates ADS-B messages. You must specify ICAO as a six-element character vector or string scalar.

`transponder = adsbTransponder(ICA0,Name,Value)` sets properties for the transponder using one or more name-value pairs. For example, `adsbTransponder('ABC123','UpdateRate',10)` creates an ADS-B transponder that has an ICAO address of ABC123 and an update rate of 10 Hz.

Properties

Unless otherwise indicated, properties are *nontunable*, which means you cannot change their values after calling the object. Objects lock when you call them, and the `release` function unlocks them.

If a property is *tunable*, you can change its value at any time.

For more information on changing property values, see [System Design in MATLAB Using System Objects](#).

ICA0 — Unique International Civil Aviation Organization address

six-element character vector | six-character string scalar

Unique International Civil Aviation Organization address, specified as a six-element character vector or a six-character string scalar.

Example: 'abc123', "abc123"

Category — Category of transponder platform

`adsbCategory(0)` (default) | `adsbCategory` object

Category of the transponder platform, specified as an `adsbCategory` enumeration object. The default value `adsbCategory(0)` represents no category information.

Callsign — Call sign of transponder platform

eight-element empty character vector (default) | eight-element character vector | eight-character string

Call sign of the transponder platform, specified as an eight-element character vector or an eight-character string scalar. The default value is an eight-element empty character vector.

Example: "abddekcf", 'abddekcf'

UpdateRate — Transponder update rate (Hz)

1 (default) | positive scalar

Transponder update rate, specified as a positive scalar in Hz.

GPS — GPS sensor providing location information

`gpsSensor('PositionInputFormat','Geodetic')` (default) | `gpsSensor` object

GPS sensor providing location information for the transponder, specified as a `gpsSensor` object. The `gpsSensor` object must specify its `PositionInputFormat` property as 'Geodetic'. The `SampleRate` of the `gpsSensor` object is automatically synchronized with the `UpdateRate` property of the `adsbTransponder`. If you set the `SampleRate` of the `gpsSensor` object to a specific value, then the `UpdateRate` property of the `adsbTransponder` object is set to the same value, and vice versa.

Usage

Syntax

```
message = transponder(position,velocity)
```

Description

`message = transponder(position,velocity)` generates ADS-B messages based on the `position` and `velocity` input arguments using a created ADS-B transponder object.

Input Arguments

position — Position of the platform

[`longitude` `latitude` `altitude`]

Position of the platform, specified as a three-element vector [`latitude` `longitude` `altitude`]. Specify `latitude` and `longitude` in degrees. `altitude` is the height above the WGS84 ellipsoid in meters.

Example: [10, 10, 2000]

velocity – Velocity of platform

three-element vector of scalars

Velocity of the platform, specified as a three-element vector of scalars in meters per second. The velocity is with respect to the local North-East-Down (NED) frame corresponding to the platform position.

Example: [10, -10, 20]

Output Arguments

message – ADS-B message

structure

ADS-B message, returned as a structure. The structure contains these fields:

ADS-B Message Structure

Field Name	Description	Default Value
ICAO	International Civil Aviation Organization address, specified as a six-element character vector or a six-character string scalar.	six-element empty character vector
Time	The ADS-B transponder broadcasting time, specified as a scalar. If the transponder is not synchronized with a reliable time source, use NaN as the value of Time so that the reception time will be used in the receiver for the message.	NaN
Category	Category of the transponder platform, specified as an <code>adsbCategory</code> enumeration object.	<code>adsbCategory(0)</code>
Callsign	Call sign of the transponder platform, specified as an eight-element character vector or an eight-character string.	eight-element empty character vector
Latitude	Reported latitude of the broadcasting transponder, specified as a scalar between -90 and 90 in degrees. Use NaN when no information is available.	NaN
Longitude	Reported longitude of the broadcasting transponder, specified as a scalar between -180 and 180 in degrees. Use NaN when no information is available.	NaN
Altitude	Reported altitude of the broadcasting transponder, specified as a scalar in meters. It represents the height above the WG84 ellipsoid. Use NaN when no information is available.	NaN
Veast	Reported velocity component in the east direction, specified as a scalar in meters per second. The positive direction for this component is the east direction. Use NaN when no information is available.	NaN
Vnorth	Reported velocity component in the north direction, specified as a scalar in meters per second. The positive direction for this component is the north direction. Use NaN when no information is available.	NaN
ClimbRate	Reported climb rate, specified as a scalar in meters per second. The positive direction for this component is the upward direction. Use NaN when no information is available.	NaN

Field Name	Description	Default Value
Heading	Reported heading direction, specified as a scalar between 0 and 360 in degrees. The heading direction angle is north at 0 and is clockwise-positive. Use NaN when no information is available.	NaN
NACPosition	<p>Navigation Accuracy Category of position, specified as an integer from 0 to 11. Each integer value defines an Estimated Position Uncertainty (EPU) bound. EPU bound is a 95% accuracy bound for the horizontal position. The bound defines a circle centered on the reported position so that the probability of the actual position lying inside the circle is 0.95. The list shows the relation between the integer and the bound:</p> <ul style="list-style-type: none"> • 0: EPU \geq 18.52 km (10 NM) or unknown • 1: EPU < 18.52 km (10 NM) • 2: EPU < 7.408 (4 NM) • 3: EPU < 3.704 (2 NM) • 4: EPU < 1852 m (1 NM) • 5: EPU < 926 m (0.5 NM) • 6: EPU < 555.6 m (0.3 NM) • 7: EPU < 185.2 m (0.1 NM) • 8: EPU < 92.6 m (0.05 NM) • 9: EPU < 30 m • 10: EPU < 10 m • 11: EPU < 3 m <p>where NM represents nautical miles.</p>	0
GeometricVertical Accuracy	<p>Geometric Vertical Accuracy (GVA) of altitude, specified as an integer from 0 to 2. Each integer value represents a 95% accuracy bound on the reported altitude. The list shows the relation between the integer and the bound:</p> <ul style="list-style-type: none"> • 0: GVA > 150 m or unknown • 1: GVA \leq 150 m • 2: GVA < 45 m 	0

Field Name	Description	Default Value
NACVelocity	<p>Navigation Accuracy Category of velocity, specified as an integer from 0 to 4. Each integer represents a 95% accuracy bound on the reported Horizontal Velocity Error (HVE). The list shows the relation between the integer and the bound:</p> <ul style="list-style-type: none"> • 0: HVE \geq 10 m/s or unknown • 1: HVE < 10 m/s • 2: HVE < 3 m/s • 3: HVE < 1 m/s • 4: HVE < 0.3 m/s 	0

Object Functions

To use an object function, specify the System object as the first input argument. For example, to release system resources of a System object named `obj`, use this syntax:

```
release(obj)
```

Common to All System Objects

<code>step</code>	Run System object algorithm
<code>release</code>	Release resources and allow changes to System object property values and input characteristics
<code>isLocked</code>	Determine if System object is in use
<code>clone</code>	Create duplicate System object
<code>reset</code>	Reset internal states of System object

Examples

Generate ADS-B Message

Create a `gpsSensor` object.

```
gps = gpsSensor('PositionInputFormat','Geodetic','HorizontalPositionAccuracy',100);
```

Create an `adsbTransponder` object based on the `gpsSensor` object.

```
transponder = adsbTransponder('ABC123', ...
    'Category',adsbCategory(12), ...
    'Callsign','X2347568', ...
    'GPS',gps);
```

Define the position and velocity of the platform.

```
truePos = [42.753 31.896 10000]; % deg deg m
trueVel = [250 0 0]; % m/s
```

Generate the ADS-B message.

```
adsbMessage = transponder(truePos,trueVel)
adsbMessage = struct with fields:
    ICAO: 'ABC123'
    Time: 0
    Category: Unmanned_Aerial_Vehicle
    Callsign: 'X2347568'
    Latitude: 42.7530
    Longitude: 31.8961
    Altitude: 1.0000e+04
    Veast: -7.5704e-04
    Vnorth: 250.0919
    ClimbRate: -0.1308
    Heading: 359.9998
    NACPosition: 6
    GeometricVerticalAccuracy: 2
    NACVelocity: 4
```

Extended Capabilities

C/C++ Code Generation

Generate C and C++ code using MATLAB® Coder™.

Usage notes and limitations:

See “System Objects in MATLAB Code Generation” (MATLAB Coder).

See Also

[adsbCategory](#) | [adsbReceiver](#)

Introduced in R2021a

altimeterSensor

Altimeter simulation model

Description

The `altimeterSensor` System object models receiving data from an altimeter sensor.

To model an altimeter:

- 1 Create the `altimeterSensor` object and set its properties.
- 2 Call the object with arguments, as if it were a function.

To learn more about how System objects work, see [What Are System Objects?](#).

Creation

Syntax

```
altimeter = altimeterSensor
altimeter = altimeterSensor('ReferenceFrame',RF)
altimeter = altimeterSensor( ____,Name,Value)
```

Description

`altimeter = altimeterSensor` returns an `altimeterSensor` System object that simulates altimeter readings.

`altimeter = altimeterSensor('ReferenceFrame',RF)` returns an `altimeterSensor` System object that simulates altimeter readings relative to the reference frame RF. Specify RF as 'NED' (North-East-Down) or 'ENU' (East-North-Up). The default value is 'NED'.

`altimeter = altimeterSensor(____,Name,Value)` sets each property Name to the specified Value. Unspecified properties have default values.

Properties

Unless otherwise indicated, properties are *nontunable*, which means you cannot change their values after calling the object. Objects lock when you call them, and the `release` function unlocks them.

If a property is *tunable*, you can change its value at any time.

For more information on changing property values, see [System Design in MATLAB Using System Objects](#).

SampleRate — Update rate of sensor (Hz)

1 (default) | positive scalar

Update rate of sensor in Hz, specified as a positive scalar.

Data Types: `single` | `double`

ConstantBias — Constant offset bias (m)

0 (default) | scalar

Constant offset bias in meters, specified as a scalar.

Tunable: Yes

Data Types: `single` | `double`

NoiseDensity — Power spectral density of sensor noise (m/√Hz)

0 (default) | nonnegative scalar

Power spectral density of sensor noise in m/√Hz, specified as a nonnegative scalar.

Tunable: Yes

Data Types: `single` | `double`

BiasInstability — Instability of bias offset (m)

0 (default) | nonnegative scalar

Instability of the bias offset in meters, specified as a nonnegative scalar.

Tunable: Yes

Data Types: `single` | `double`

DecayFactor — Bias instability noise decay factor

0 (default) | scalar in the range [0,1]

Bias instability noise decay factor, specified as a scalar in the range [0,1]. A decay factor of 0 models the bias instability noise as a white noise process. A decay factor of 1 models the bias instability noise as a random walk process.

Tunable: Yes

Data Types: `single` | `double`

RandomStream — Random number source

'Global stream' (default) | 'mt19937ar with seed'

Random number source, specified as a character vector or string:

- 'Global stream' -- Random numbers are generated using the current global random number stream.
- 'mt19937ar with seed' -- Random numbers are generated using the mt19937ar algorithm with the seed specified by the Seed property.

Data Types: `char` | `string`

Seed — Initial seed

67 (default) | nonnegative integer scalar

Initial seed of an mt19937ar random number generator algorithm, specified as a nonnegative integer scalar.

Dependencies

To enable this property, set `RandomStream` to 'mt19937ar with seed'.

Data Types: `single` | `double`

Usage

Syntax

```
altimeterReadings = altimeter(position)
```

Description

`altimeterReadings = altimeter(position)` generates an altimeter sensor altitude reading from the `position` input.

Input Arguments

position — Position of sensor in local navigation coordinate system (m)

N-by-3 matrix

Position of sensor in the local navigation coordinate system, specified as an *N*-by-3 matrix with elements measured in meters. *N* is the number of samples in the current frame.

Data Types: `single` | `double`

Output Arguments

altimeterReadings — Altitude of sensor relative to local navigation coordinate system (m)

N-element column vector

Altitude of sensor relative to the local navigation coordinate system in meters, returned as an *N*-element column vector. *N* is the number of samples in the current frame.

Data Types: `single` | `double`

Object Functions

To use an object function, specify the `System` object as the first input argument. For example, to release system resources of a `System` object named `obj`, use this syntax:

```
release(obj)
```

Common to All System Objects

<code>step</code>	Run <code>System</code> object algorithm
<code>release</code>	Release resources and allow changes to <code>System</code> object property values and input characteristics
<code>reset</code>	Reset internal states of <code>System</code> object

Examples

Generate Noisy Altimeter Readings from Stationary Input

Create an `altimeterSensor` System object™ to model receiving altimeter sensor data. Assume a typical one Hz sample rate and a 10 minute simulation time. Set `ConstantBias` to 0.01, `NoiseDensity` to 0.05, `BiasInstability` to 0.05, and `DecayFactor` to 0.5.

```
Fs = 1;  
duration = 60*10;  
numSamples = duration*Fs;
```

```
altimeter = altimeterSensor('SampleRate',Fs, ...  
                             'ConstantBias',0.01, ...  
                             'NoiseDensity',0.05, ...  
                             'BiasInstability',0.05, ...  
                             'DecayFactor',0.5);
```

```
truePosition = zeros(numSamples,3);
```

Call `altimeter` with the specified `truePosition` to model noisy altimeter readings from a stationary platform.

```
altimeterReadings = altimeter(truePosition);
```

Plot the true position and the altimeter sensor readings for height.

```
t = (0:(numSamples-1))/Fs;  
  
plot(t,altimeterReadings)  
hold on  
plot(t,truePosition(:,3),'LineWidth',2)  
hold off  
title('Altimeter Readings')  
xlabel('Time (s)')  
ylabel('Height (m)')  
legend('Altimeter Readings','Ground Truth')
```

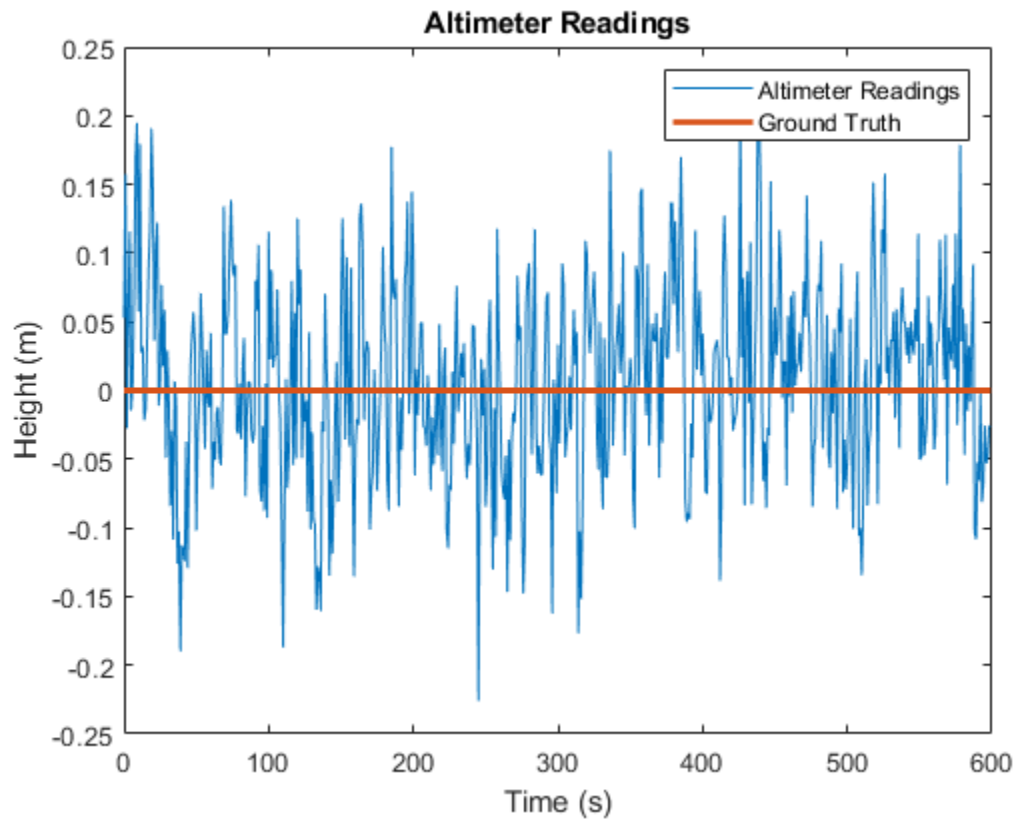
Extended Capabilities

C/C++ Code Generation

Generate C and C++ code using MATLAB® Coder™.

Usage notes and limitations:

See “System Objects in MATLAB Code Generation” (MATLAB Coder).

See Also

[gpsSensor](#) | [imuSensor](#) | [insSensor](#)

Topics

“Model IMU, GPS, and INS/GPS”

Introduced in R2019a

ahrsfilter

Orientation from accelerometer, gyroscope, and magnetometer readings

Description

The `ahrsfilter` System object fuses accelerometer, magnetometer, and gyroscope sensor data to estimate device orientation.

To estimate device orientation:

- 1 Create the `ahrsfilter` object and set its properties.
- 2 Call the object with arguments, as if it were a function.

To learn more about how System objects work, see [What Are System Objects?](#).

Creation

Syntax

```
FUSE = ahrsfilter
FUSE = ahrsfilter('ReferenceFrame',RF)
FUSE = ahrsfilter( ____,Name,Value)
```

Description

`FUSE = ahrsfilter` returns an indirect Kalman filter System object, `FUSE`, for sensor fusion of accelerometer, gyroscope, and magnetometer data to estimate device orientation and angular velocity. The filter uses a 12-element state vector to track the estimation error for the orientation, the gyroscope bias, the linear acceleration, and the magnetic disturbance.

`FUSE = ahrsfilter('ReferenceFrame',RF)` returns an `ahrsfilter` System object that fuses accelerometer, gyroscope, and magnetometer data to estimate device orientation relative to the reference frame `RF`. Specify `RF` as `'NED'` (North-East-Down) or `'ENU'` (East-North-Up). The default value is `'NED'`.

`FUSE = ahrsfilter(____,Name,Value)` sets each property `Name` to the specified `Value`. Unspecified properties have default values.

Properties

Unless otherwise indicated, properties are *nontunable*, which means you cannot change their values after calling the object. Objects lock when you call them, and the `release` function unlocks them.

If a property is *tunable*, you can change its value at any time.

For more information on changing property values, see [System Design in MATLAB Using System Objects](#).

SampleRate — Input sample rate of sensor data (Hz)

100 (default) | positive scalar

Input sample rate of the sensor data in Hz, specified as a positive scalar.

Tunable: No

Data Types: single | double

DecimationFactor — Decimation factor

1 (default) | positive integer

Decimation factor by which to reduce the input sensor data rate as part of the fusion algorithm, specified as a positive integer.

The number of rows of the inputs -- `accelReadings`, `gyroReadings`, and `magReadings` -- must be a multiple of the decimation factor.

Data Types: single | double

AccelerometerNoise — Variance of accelerometer signal noise ((m/s²)²)

0.00019247 (default) | positive real scalar

Variance of accelerometer signal noise in (m/s²)², specified as a positive real scalar.

Tunable: Yes

Data Types: single | double

MagnetometerNoise — Variance of magnetometer signal noise (μT²)

0.1 (default) | positive real scalar

Variance of magnetometer signal noise in μT², specified as a positive real scalar.

Tunable: Yes

Data Types: single | double

GyroscopeNoise — Variance of gyroscope signal noise ((rad/s)²)

9.1385e-5 (default) | positive real scalar

Variance of gyroscope signal noise in (rad/s)², specified as a positive real scalar.

Tunable: Yes

Data Types: single | double

GyroscopeDriftNoise — Variance of gyroscope offset drift ((rad/s)²)

3.0462e-13 (default) | positive real scalar

Variance of gyroscope offset drift in (rad/s)², specified as a positive real scalar.

Tunable: Yes

Data Types: single | double

LinearAccelerationNoise — Variance of linear acceleration noise (m/s²)²

0.0096236 (default) | positive real scalar

Variance of linear acceleration noise in $(\text{m/s}^2)^2$, specified as a positive real scalar. Linear acceleration is modeled as a lowpass-filtered white noise process.

Tunable: Yes

Data Types: single | double

LinearAccelerationDecayFactor — Decay factor for linear acceleration drift

0.5 (default) | scalar in the range [0,1]

Decay factor for linear acceleration drift, specified as a scalar in the range [0,1]. If linear acceleration is changing quickly, set `LinearAccelerationDecayFactor` to a lower value. If linear acceleration changes slowly, set `LinearAccelerationDecayFactor` to a higher value. Linear acceleration drift is modeled as a lowpass-filtered white noise process.

Tunable: Yes

Data Types: single | double

MagneticDisturbanceNoise — Variance of magnetic disturbance noise (μT^2)

0.5 (default) | real finite positive scalar

Variance of magnetic disturbance noise in μT^2 , specified as a real finite positive scalar.

Tunable: Yes

Data Types: single | double

MagneticDisturbanceDecayFactor — Decay factor for magnetic disturbance

0.5 (default) | positive scalar in the range [0,1]

Decay factor for magnetic disturbance, specified as a positive scalar in the range [0,1]. Magnetic disturbance is modeled as a first order Markov process.

Tunable: Yes

Data Types: single | double

InitialProcessNoise — Covariance matrix for process noise

12-by-12 matrix

Covariance matrix for process noise, specified as a 12-by-12 matrix. The default is:

Columns 1 through 6

0.000006092348396	0	0	0	0	0
0	0.000006092348396	0	0	0	0
0	0	0.000006092348396	0	0	0
0	0	0	0.000076154354947	0	0.00007615435
0	0	0	0	0	0
0	0	0	0	0	0
0	0	0	0	0	0
0	0	0	0	0	0
0	0	0	0	0	0
0	0	0	0	0	0
0	0	0	0	0	0
0	0	0	0	0	0

Columns 7 through 12

```

          0          0          0          0
          0          0          0          0
          0          0          0          0
          0          0          0          0
          0          0          0          0
          0          0          0          0
0.009623610000000 0          0          0
          0 0.009623610000000 0          0
          0          0 0.009623610000000 0
          0          0          0 0.600000000000000 0
          0          0          0          0 0.600000000000000
          0          0          0          0          0

```

The initial process covariance matrix accounts for the error in the process model.

Data Types: `single` | `double`

ExpectedMagneticFieldStrength — Expected estimate of magnetic field strength (μT)

50 (default) | real positive scalar

Expected estimate of magnetic field strength in μT , specified as a real positive scalar. The expected magnetic field strength is an estimate of the magnetic field strength of the Earth at the current location.

Tunable: Yes

Data Types: `single` | `double`

OrientationFormat — Output orientation format

'quaternion' (default) | 'Rotation matrix'

Output orientation format, specified as 'quaternion' or 'Rotation matrix'. The size of the output depends on the input size, N , and the output orientation format:

- 'quaternion' -- Output is an N -by-1 quaternion.
- 'Rotation matrix' -- Output is a 3-by-3-by- N rotation matrix.

Data Types: `char` | `string`

Usage

Syntax

```
[orientation,angularVelocity] = FUSE(accelReadings,gyroReadings,magReadings)
```

Description

`[orientation,angularVelocity] = FUSE(accelReadings,gyroReadings,magReadings)` fuses accelerometer, gyroscope, and magnetometer data to compute orientation and angular velocity measurements. The algorithm assumes that the device is stationary before the first call.

Input Arguments

accelReadings — Accelerometer readings in sensor body coordinate system (m/s²)

N-by-3 matrix

Accelerometer readings in the sensor body coordinate system in m/s², specified as an *N*-by-3 matrix. *N* is the number of samples, and the three columns of `accelReadings` represent the [x y z] measurements. Accelerometer readings are assumed to correspond to the sample rate specified by the `SampleRate` property.

Data Types: `single` | `double`

gyroReadings — Gyroscope readings in sensor body coordinate system (rad/s)

N-by-3 matrix

Gyroscope readings in the sensor body coordinate system in rad/s, specified as an *N*-by-3 matrix. *N* is the number of samples, and the three columns of `gyroReadings` represent the [x y z] measurements. Gyroscope readings are assumed to correspond to the sample rate specified by the `SampleRate` property.

Data Types: `single` | `double`

magReadings — Magnetometer readings in sensor body coordinate system (μT)

N-by-3 matrix

Magnetometer readings in the sensor body coordinate system in μT, specified as an *N*-by-3 matrix. *N* is the number of samples, and the three columns of `magReadings` represent the [x y z] measurements. Magnetometer readings are assumed to correspond to the sample rate specified by the `SampleRate` property.

Data Types: `single` | `double`

Output Arguments

orientation — Orientation that rotates quantities from local navigation coordinate system to sensor body coordinate system

M-by-1 array of quaternions (default) | 3-by-3-by-*M* array

Orientation that can rotate quantities from the local navigation coordinate system to a body coordinate system, returned as quaternions or an array. The size and type of `orientation` depends on whether the `OrientationFormat` property is set to 'quaternion' or 'Rotation matrix':

- 'quaternion' -- the output is an *M*-by-1 vector of quaternions, with the same underlying data type as the inputs
- 'Rotation matrix' -- the output is a 3-by-3-by-*M* array of rotation matrices the same data type as the inputs

The number of input samples, *N*, and the `DecimationFactor` property determine *M*.

You can use `orientation` in a `rotateframe` function to rotate quantities from a local navigation system to a sensor body coordinate system.

Data Types: `quaternion` | `single` | `double`

angularVelocity — Angular velocity in sensor body coordinate system (rad/s)

M-by-3 array (default)

Angular velocity with gyroscope bias removed in the sensor body coordinate system in rad/s, returned as an M -by-3 array. The number of input samples, N , and the DecimationFactor property determine M .

Data Types: `single` | `double`

Object Functions

To use an object function, specify the System object as the first input argument. For example, to release system resources of a System object named `obj`, use this syntax:

```
release(obj)
```

Specific to ahrsfilter

`tune` Tune ahrsfilter parameters to reduce estimation error

Common to All System Objects

`step` Run System object algorithm
`release` Release resources and allow changes to System object property values and input characteristics
`reset` Reset internal states of System object

Examples

Estimate Orientation Using ahrsfilter

Load the `rpy_9axis` file, which contains recorded accelerometer, gyroscope, and magnetometer sensor data from a device oscillating in pitch (around y -axis), then yaw (around z -axis), and then roll (around x -axis). The file also contains the sample rate of the recording.

```
load 'rpy_9axis' sensorData Fs
accelerometerReadings = sensorData.Acceleration;
gyroscopeReadings = sensorData.AngularVelocity;
magnetometerReadings = sensorData.MagneticField;
```

Create an ahrsfilter System object™ with `SampleRate` set to the sample rate of the sensor data. Specify a decimation factor of two to reduce the computational cost of the algorithm.

```
decim = 2;
fuse = ahrsfilter('SampleRate',Fs,'DecimationFactor',decim);
```

Pass the accelerometer readings, gyroscope readings, and magnetometer readings to the ahrsfilter object, `fuse`, to output an estimate of the sensor body orientation over time. By default, the orientation is output as a vector of quaternions.

```
q = fuse(accelerometerReadings,gyroscopeReadings,magnetometerReadings);
```

Orientation is defined by angular displacement required to rotate a parent coordinate system to a child coordinate system. Plot the orientation in Euler angles in degrees over time.

ahrsfilter correctly estimates the change in orientation over time, including the south-facing initial orientation.

```
time = (0:decim:size(accelerometerReadings,1)-1)/Fs;
```

```
plot(time,eulerd(q,'ZYX','frame'))
title('Orientation Estimate')
legend('z-axis', 'y-axis', 'x-axis')
ylabel('Rotation (degrees)')
```

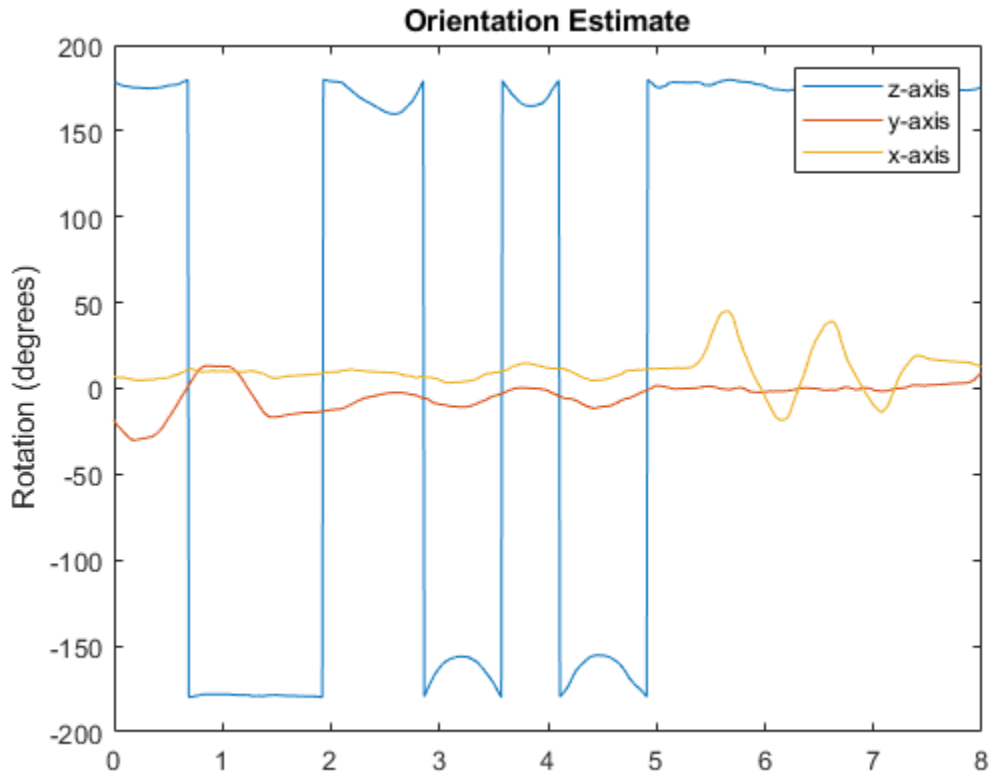

Simulate Magnetic Jamming on ahrsFilter

This example shows how performance of the `ahrsfilter` System object™ is affected by magnetic jamming.

Load `StationaryIMUReadings`, which contains accelerometer, magnetometer, and gyroscope readings from a stationary IMU.

```
load 'StationaryIMUReadings.mat' accelReadings magReadings gyroReadings SampleRate
```

```
numSamples = size(accelReadings,1);
```

The `ahrsfilter` uses magnetic field strength to stabilize its orientation against the assumed constant magnetic field of the Earth. However, there are many natural and man-made objects which output magnetic fields and can confuse the algorithm. To account for the presence of transient magnetic fields, you can set the `MagneticDisturbanceNoise` property on the `ahrsfilter` object.

Create an `ahrsfilter` object with the decimation factor set to 2 and note the default expected magnetic field strength.

```
decim = 2;
FUSE = ahrsfilter('SampleRate',SampleRate,'DecimationFactor',decim);
```

Fuse the IMU readings using the attitude and heading reference system (AHRS) filter, and then visualize the orientation of the sensor body over time. The orientation fluctuates at the beginning and stabilizes after approximately 60 seconds.

```
orientation = FUSE(accelReadings,gyroReadings,magReadings);

orientationEulerAngles = eulerd(orientation,'ZYX','frame');
time = (0:decim:(numSamples-1))'/SampleRate;

figure(1)
plot(time,orientationEulerAngles(:,1), ...
      time,orientationEulerAngles(:,2), ...
      time,orientationEulerAngles(:,3))
xlabel('Time (s)')
ylabel('Rotation (degrees)')
legend('z-axis','y-axis','x-axis')
title('Filtered IMU Data')
```

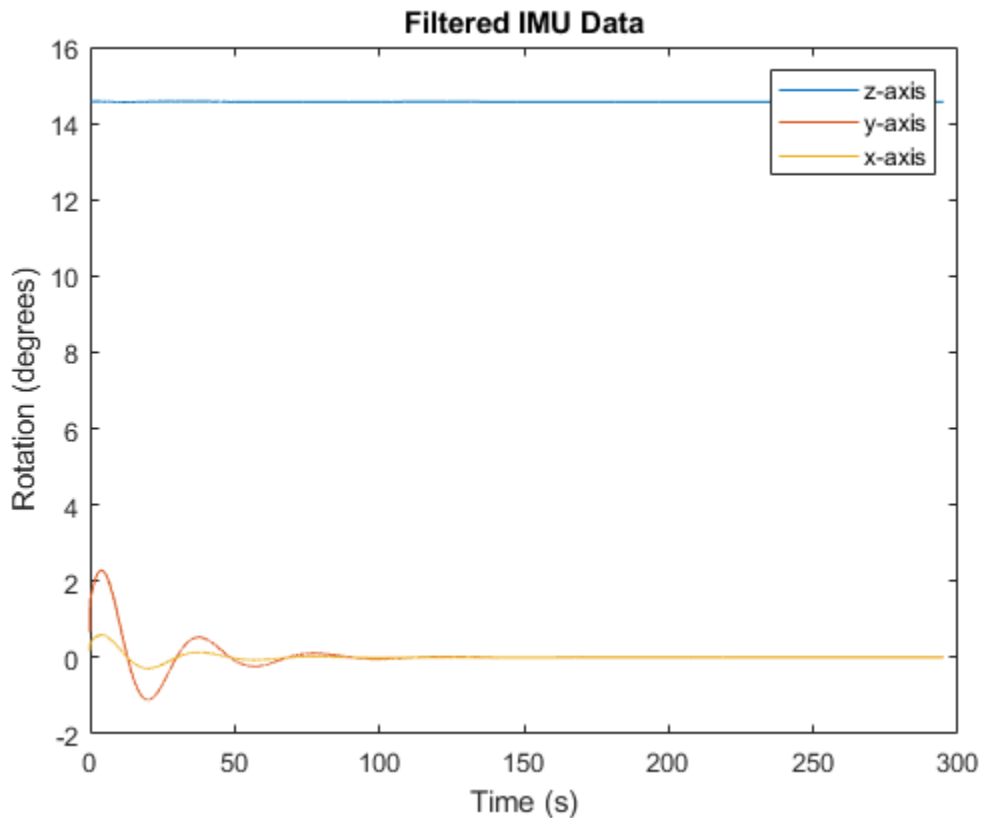

Mimic magnetic jamming by adding a transient, strong magnetic field to the magnetic field recorded in the `magReadings`. Visualize the magnetic field jamming.

```

jamStrength = [10,5,2];
startStop = (50*SampleRate):(150*SampleRate);
jam = zeros(size(magReadings));
jam(startStop,:) = jamStrength.*ones(numel(startStop),3);

magReadings = magReadings + jam;

figure(2)
plot(time,magReadings(1:decim:end,:))
xlabel('Time (s)')
ylabel('Magnetic Field Strength (\mu T)')
title('Simulated Magnetic Field with Jamming')
legend('z-axis','y-axis','x-axis')

```

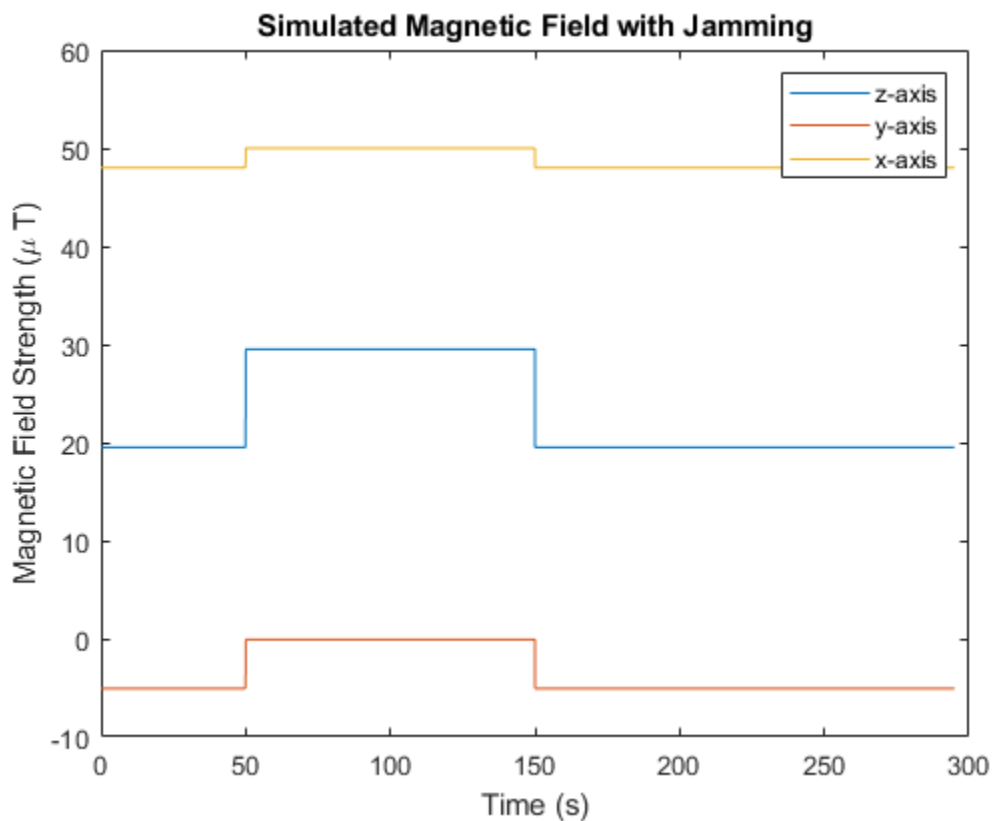

Run the simulation again using the `magReadings` with magnetic jamming. Plot the results and note the decreased performance in orientation estimation.

```

reset(FUSE)
orientation = FUSE(accelReadings,gyroReadings,magReadings);

orientationEulerAngles = eulerd(orientation,'ZYX','frame');

figure(3)
plot(time,orientationEulerAngles(:,1), ...
      time,orientationEulerAngles(:,2), ...
      time,orientationEulerAngles(:,3))
xlabel('Time (s)')
ylabel('Rotation (degrees)')

```

```

legend('z-axis','y-axis','x-axis')
title('Filtered IMU Data with Magnetic Disturbance and Default Properties')

```

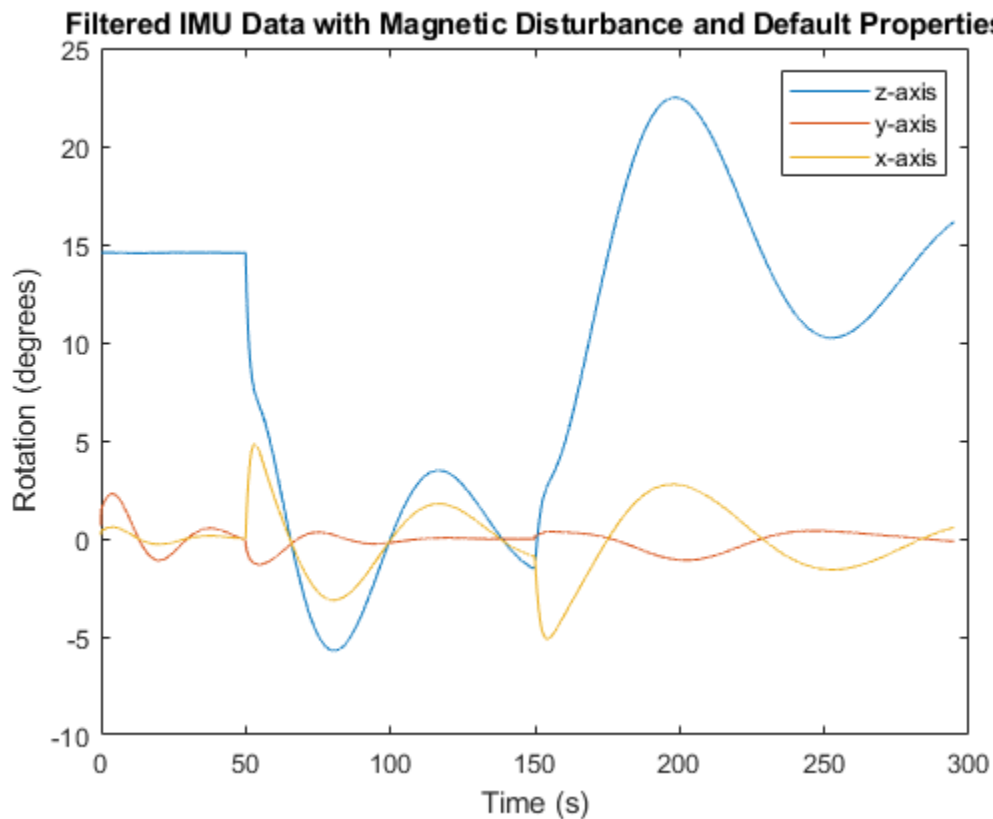

The magnetic jamming was misinterpreted by the AHRS filter, and the sensor body orientation was incorrectly estimated. You can compensate for jamming by increasing the `MagneticDisturbanceNoise` property. Increasing the `MagneticDisturbanceNoise` property increases the assumed noise range for magnetic disturbance, and the entire magnetometer signal is weighted less in the underlying fusion algorithm of `ahrsfilter`.

Set the `MagneticDisturbanceNoise` to 200 and run the simulation again.

The orientation estimation output from `ahrsfilter` is more accurate and less affected by the magnetic transient. However, because the magnetometer signal is weighted less in the underlying fusion algorithm, the algorithm may take more time to restabilize.

```

reset(FUSE)
FUSE.MagneticDisturbanceNoise = 20;

orientation = FUSE(accelReadings,gyroReadings,magReadings);

orientationEulerAngles = eulerd(orientation,'ZYX','frame');

figure(4)
plot(time,orientationEulerAngles(:,1), ...
      time,orientationEulerAngles(:,2), ...
      time,orientationEulerAngles(:,3))
xlabel('Time (s)')

```

```

ylabel('Rotation (degrees)')
legend('z-axis','y-axis','x-axis')
title('Filtered IMU Data with Magnetic Disturbance and Modified Properties')

```

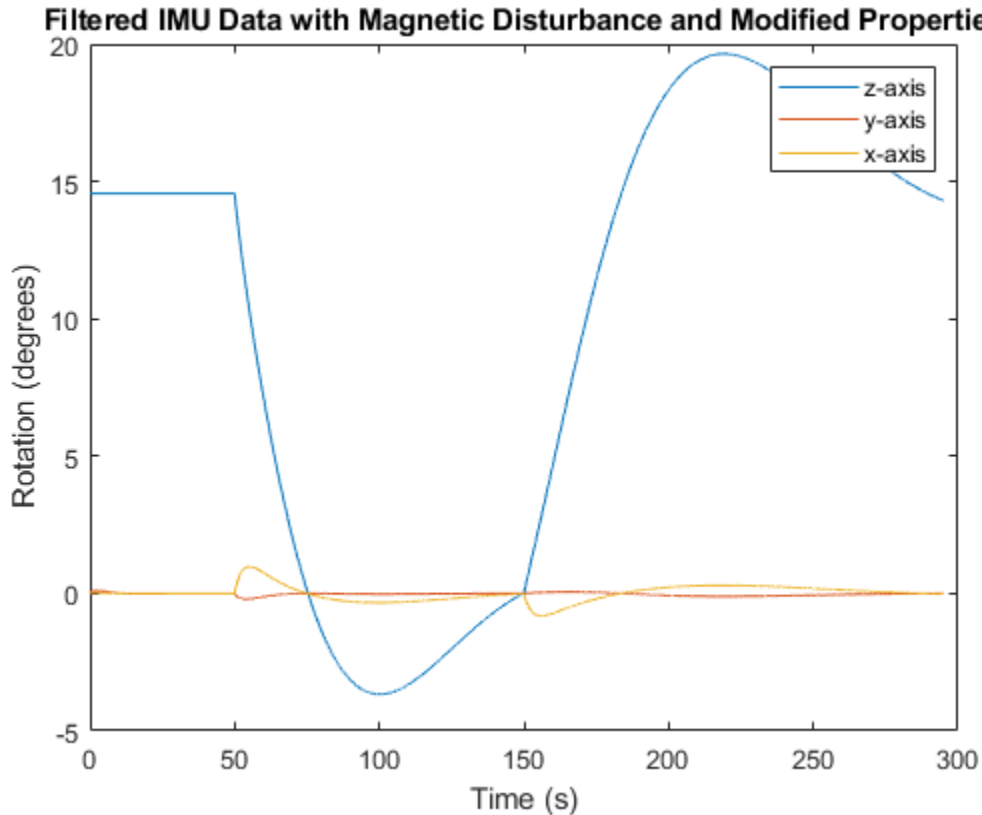

Track Shaking 9-Axis IMU

This example uses the `ahrsfilter` System object™ to fuse 9-axis IMU data from a sensor body that is shaken. Plot the quaternion distance between the object and its final resting position to visualize performance and how quickly the filter converges to the correct resting position. Then tune parameters of the `ahrsfilter` so that the filter converges more quickly to the ground-truth resting position.

Load `IMUReadingsShaken` into your current workspace. This data was recorded from an IMU that was shaken then laid in a resting position. Visualize the acceleration, magnetic field, and angular velocity as recorded by the sensors.

```

load 'IMUReadingsShaken' accelReadings gyroReadings magReadings SampleRate
numSamples = size(accelReadings,1);
time = (0:(numSamples-1))/SampleRate;

figure(1)
subplot(3,1,1)
plot(time,accelReadings)
title('Accelerometer Reading')
ylabel('Acceleration (m/s^2)')

```

```

subplot(3,1,2)
plot(time,magReadings)
title('Magnetometer Reading')
ylabel('Magnetic Field (\u00b5T)')

subplot(3,1,3)
plot(time,gyroReadings)
title('Gyroscope Reading')
ylabel('Angular Velocity (rad/s)')
xlabel('Time (s)')

```

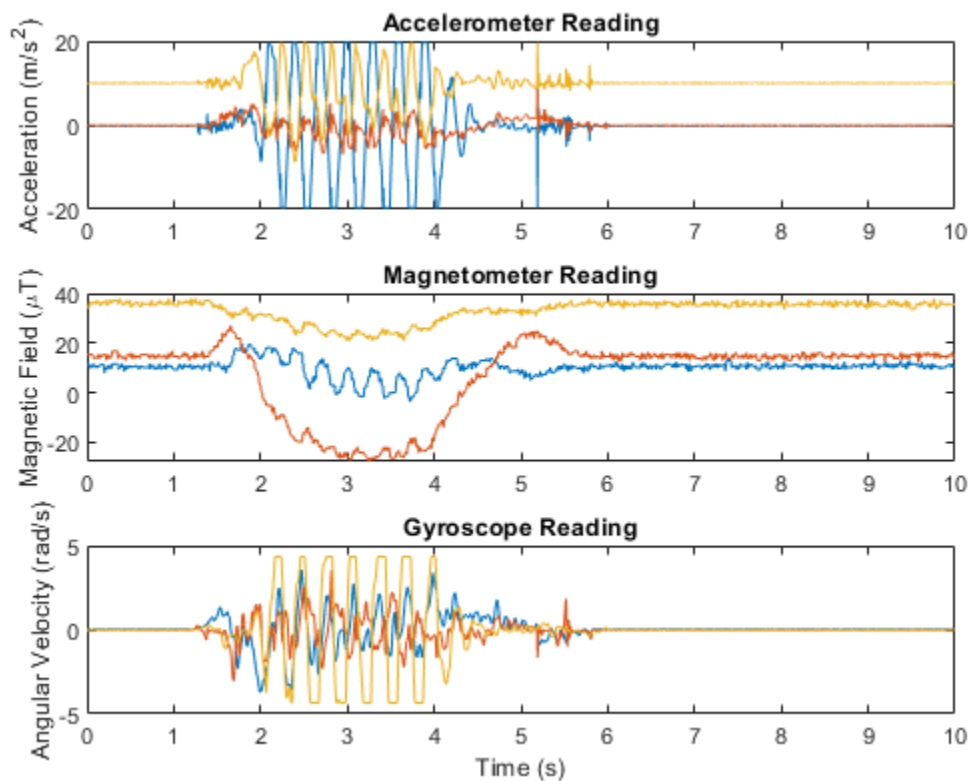

Create an `ahrsfilter` and then fuse the IMU data to determine orientation. The orientation is returned as a vector of quaternions; convert the quaternions to Euler angles in degrees. Visualize the orientation of the sensor body over time by plotting the Euler angles required, at each time step, to rotate the global coordinate system to the sensor body coordinate system.

```

fuse = ahrsfilter('SampleRate',SampleRate);
orientation = fuse(accelReadings,gyroReadings,magReadings);

orientationEulerAngles = eulerd(orientation,'ZYX','frame');

figure(2)
plot(time,orientationEulerAngles(:,1), ...
      time,orientationEulerAngles(:,2), ...
      time,orientationEulerAngles(:,3))
xlabel('Time (s)')

```

```

ylabel('Rotation (degrees)')
title('Orientation over Time')
legend('Rotation around z-axis', ...
       'Rotation around y-axis', ...
       'Rotation around x-axis')

```

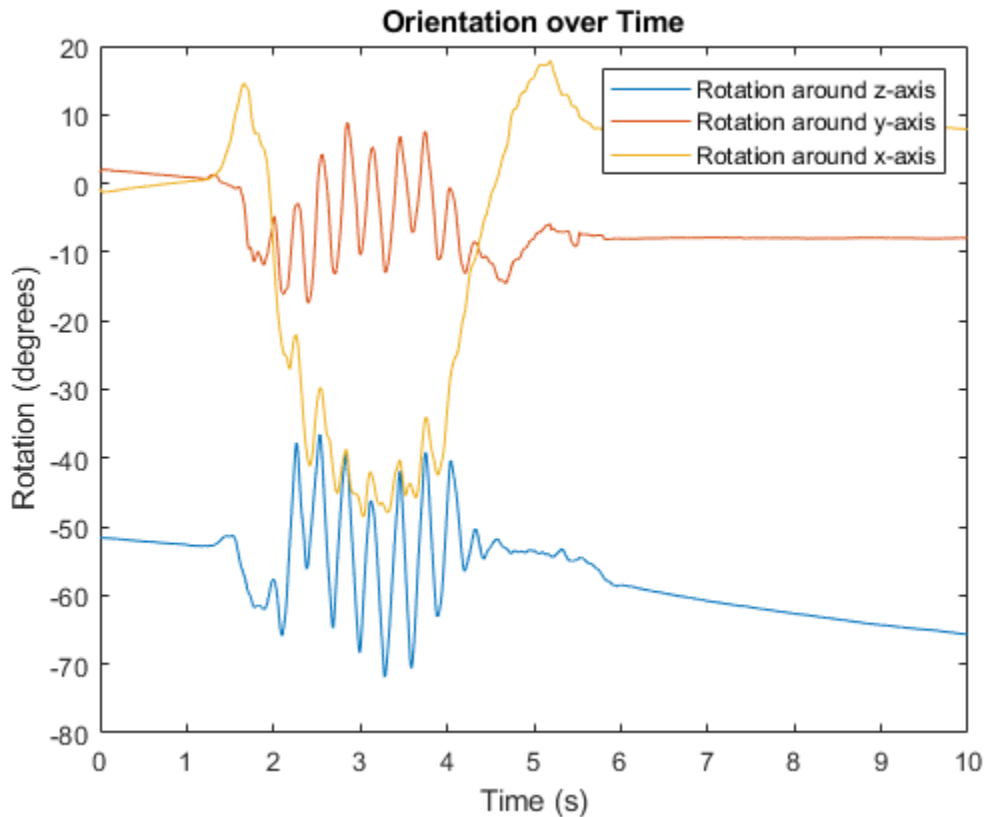

In the IMU recording, the shaking stops after approximately six seconds. Determine the resting orientation so that you can characterize how fast the `ahrsfilter` converges.

To determine the resting orientation, calculate the averages of the magnetic field and acceleration for the final four seconds and then use the `ecompass` function to fuse the data.

Visualize the quaternion distance from the resting position over time.

```

restingOrientation = ecompass(mean(accelReadings(6*SampleRate:end,:)), ...
                             mean(magReadings(6*SampleRate:end,:)));

```

```

figure(3)
plot(time, rad2deg(dist(restingOrientation, orientation)))
hold on
xlabel('Time (s)')
ylabel('Quaternion Distance (degrees)')

```

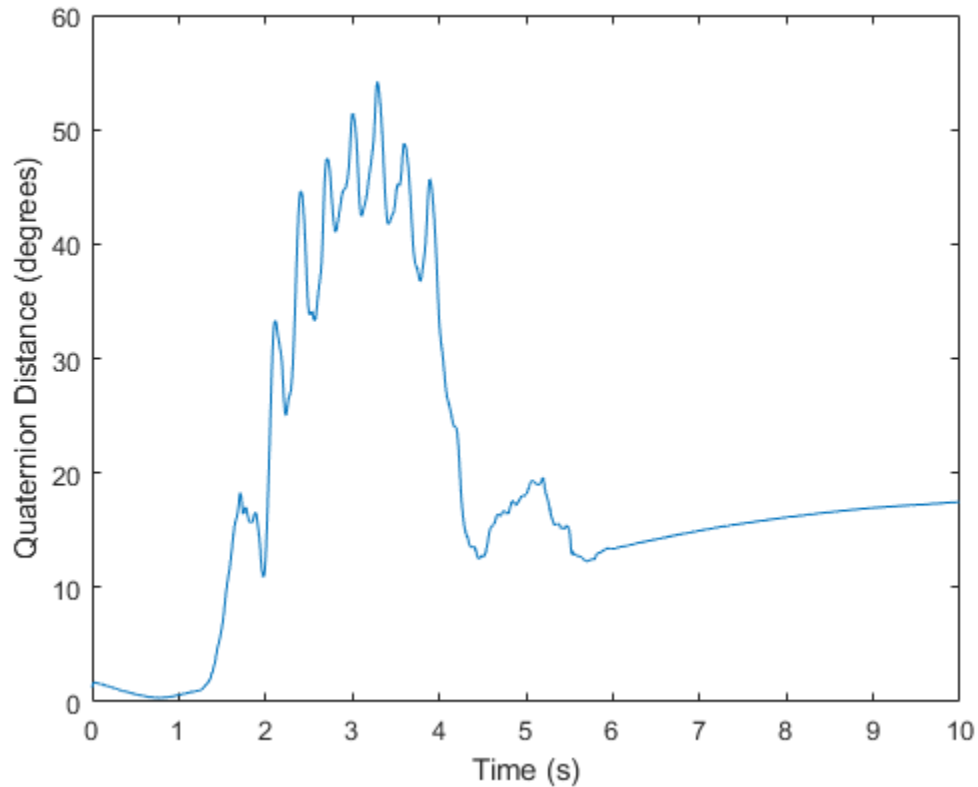

Modify the default `ahrsfilter` properties so that the filter converges to gravity more quickly. Increase the `GyroscopeDriftNoise` to $1e-2$ and decrease the `LinearAccelerationNoise` to $1e-4$. This instructs the `ahrsfilter` algorithm to weigh gyroscope data less and accelerometer data more. Because the accelerometer data provides the stabilizing and consistent gravity vector, the resulting orientation converges more quickly.

Reset the filter, fuse the data, and plot the results.

```
fuse.LinearAccelerationNoise = 1e-4;
fuse.GyroscopeDriftNoise    = 1e-2;
reset(fuse)

orientation = fuse(accelReadings,gyroReadings,magReadings);

figure(3)
plot(time,rad2deg(dist(restingOrientation,orientation)))
legend('Default AHRS Filter','Tuned AHRS Filter')
```

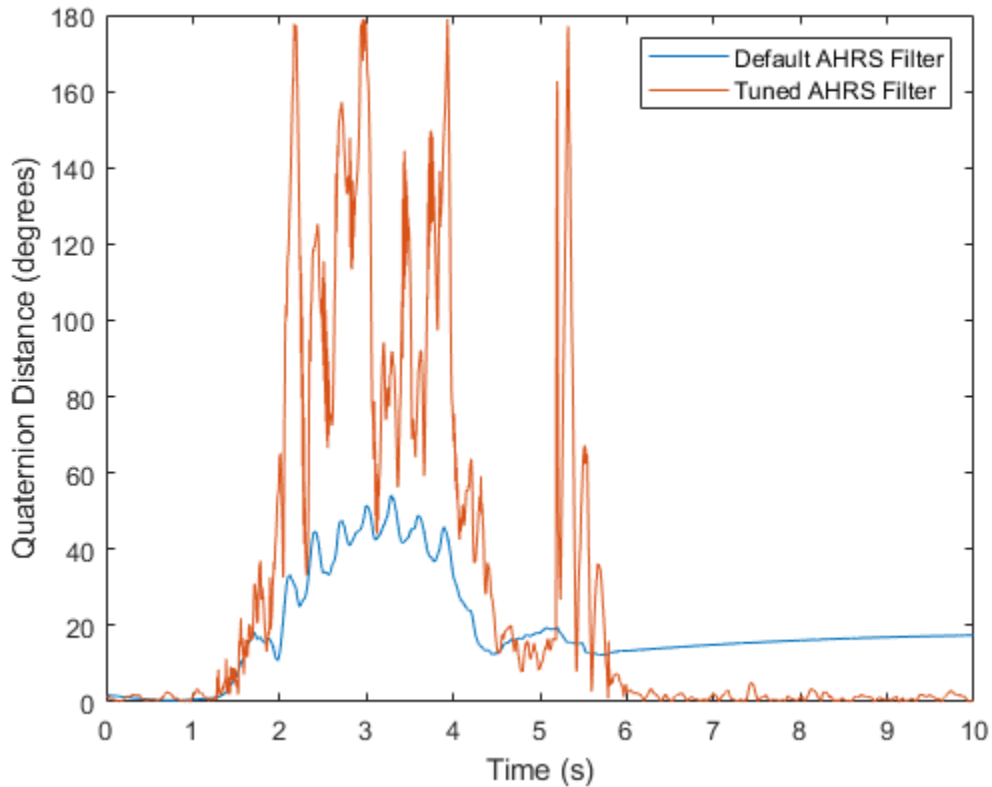

Algorithms

Note: The following algorithm only applies to an NED reference frame.

The `ahrsfilter` uses the nine-axis Kalman filter structure described in [1]. The algorithm attempts to track the errors in orientation, gyroscope offset, linear acceleration, and magnetic disturbance to output the final orientation and angular velocity. Instead of tracking the orientation directly, the indirect Kalman filter models the error process, x , with a recursive update:

$$x_k = \begin{bmatrix} \theta_k \\ b_k \\ a_k \\ d_k \end{bmatrix} = F_k \begin{bmatrix} \theta_{k-1} \\ b_{k-1} \\ a_{k-1} \\ d_{k-1} \end{bmatrix} + w_k$$

where x_k is a 12-by-1 vector consisting of:

- θ_k -- 3-by-1 orientation error vector, in degrees, at time k
- b_k -- 3-by-1 gyroscope zero angular rate bias vector, in deg/s, at time k
- a_k -- 3-by-1 acceleration error vector measured in the sensor frame, in g, at time k
- d_k -- 3-by-1 magnetic disturbance error vector measured in the sensor frame, in μT , at time k

and where w_k is a 12-by-1 additive noise vector, and F_k is the state transition model.

Because x_k is defined as the error process, the *a priori* estimate is always zero, and therefore the state transition model, F_k , is zero. This insight results in the following reduction of the standard Kalman equations:

Standard Kalman equations:

$$\begin{aligned}x_k^- &= F_k x_{k-1}^+ \\P_k^- &= F_k P_{k-1}^+ F_k^T + Q_k \\y_k &= z_k - H_k x_k^- \\S_k &= R_k + H_k P_k^- H_k^T \\K_k &= P_k^- H_k^T (S_k)^{-1} \\x_k^+ &= x_k^- + K_k y_k \\P_k^+ &= P_k^- - K_k H_k P_k^-\end{aligned}$$

Kalman equations used in this algorithm:

$$\begin{aligned}x_k^- &= 0 \\P_k^- &= Q_k \\y_k &= z_k \\S_k &= R_k + H_k P_k^- H_k^T \\K_k &= P_k^- H_k^T (S_k)^{-1} \\x_k^+ &= K_k y_k \\P_k^+ &= P_k^- - K_k H_k P_k^-\end{aligned}$$

where:

- x_k^- -- predicted (*a priori*) state estimate; the error process
- P_k^- -- predicted (*a priori*) estimate covariance
- y_k -- innovation
- S_k -- innovation covariance
- K_k -- Kalman gain
- x_k^+ -- updated (*a posteriori*) state estimate
- P_k^+ -- updated (*a posteriori*) estimate covariance

k represents the iteration, the superscript $+$ represents an *a posteriori* estimate, and the superscript $-$ represents an *a priori* estimate.

The graphic and following steps describe a single frame-based iteration through the algorithm.

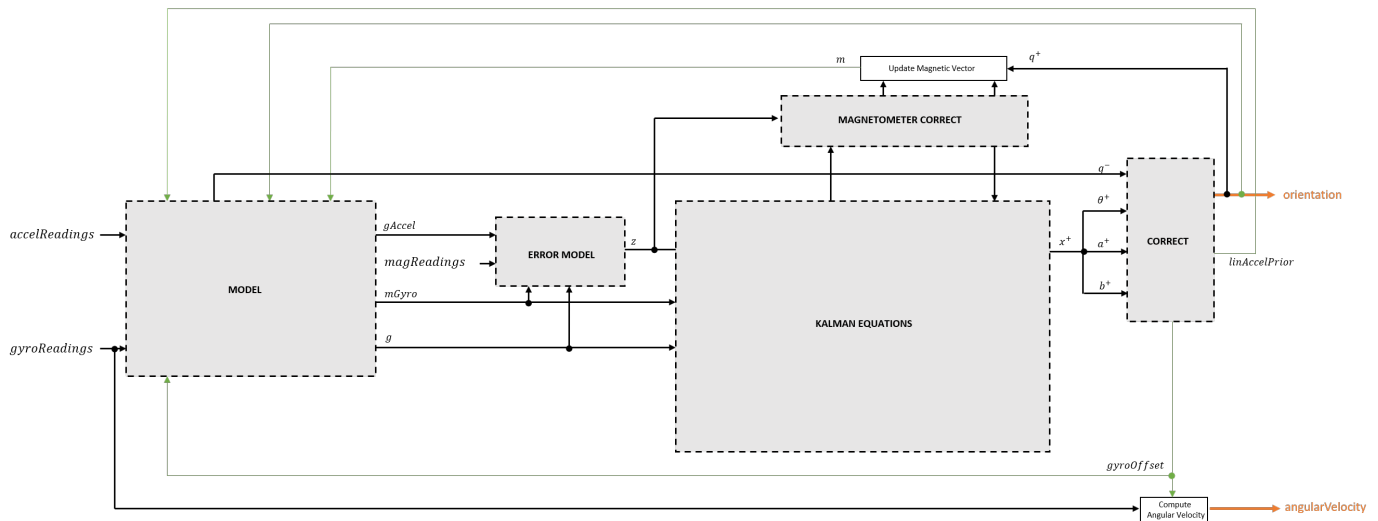

Before the first iteration, the `accelReadings`, `gyroReadings`, and `magReadings` inputs are chunked into DecimationFactor-by-3 frames. For each chunk, the algorithm uses the most current accelerometer and magnetometer readings corresponding to the chunk of gyroscope readings.

Detailed Overview

Walk through the algorithm for an explanation of each stage of the detailed overview.

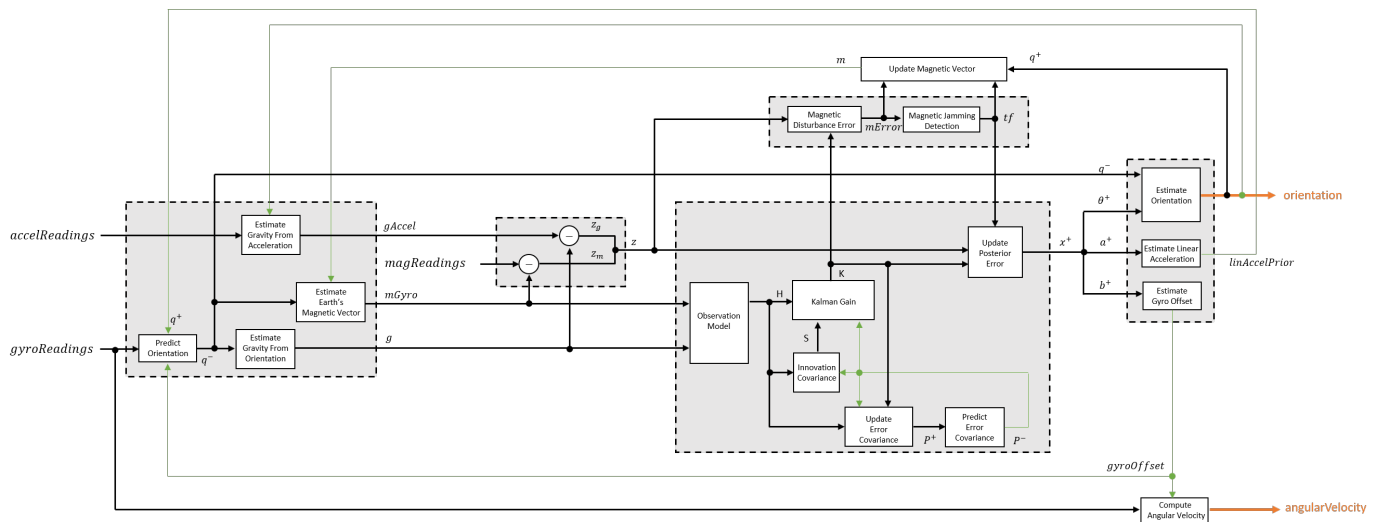

Model

The algorithm models acceleration and angular change as linear processes.

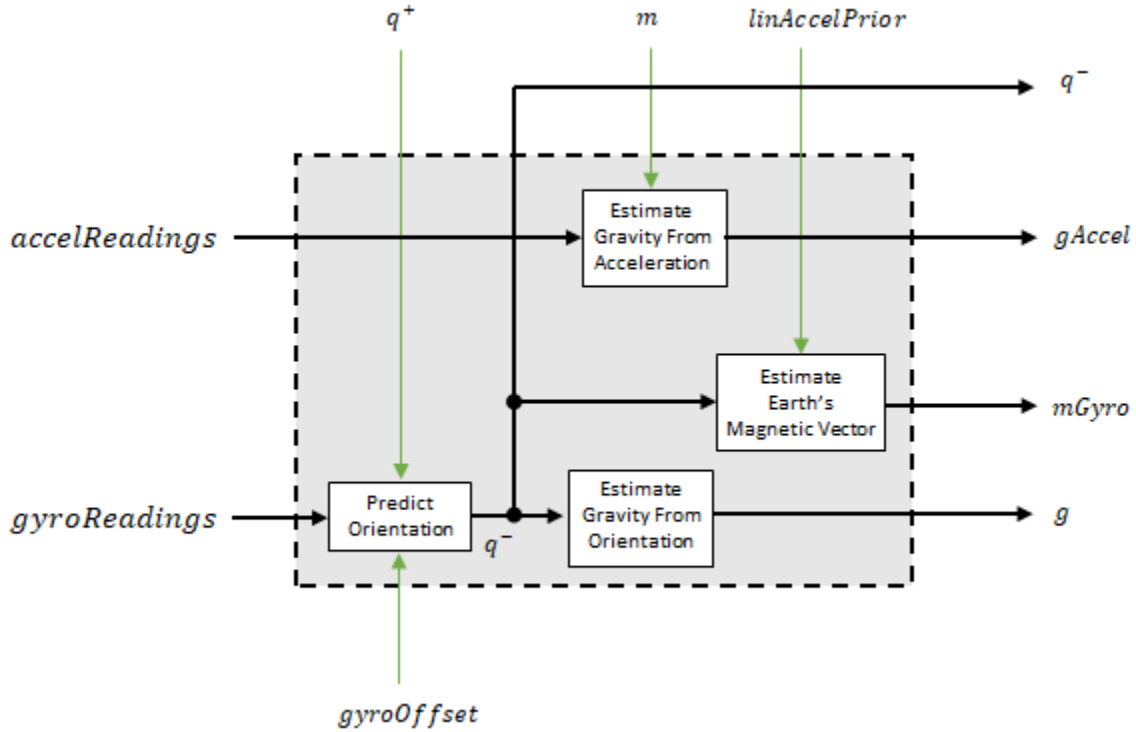

Predict Orientation

The orientation for the current frame is predicted by first estimating the angular change from the previous frame:

$$\Delta\varphi_{N \times 3} = \frac{(\text{gyroReadings}_{N \times 3} - \text{gyroOffset}_{1 \times 3})}{fs}$$

where N is the decimation factor specified by the DecimationFactor property and fs is the sample rate specified by the SampleRate property.

The angular change is converted into quaternions using the `rotvec` quaternion construction syntax:

$$\Delta Q_{N \times 1} = \text{quaternion}(\Delta\varphi_{N \times 3}, 'rotvec')$$

The previous orientation estimate is updated by rotating it by ΔQ :

$$q_{1 \times 1}^- = (q_{1 \times 1}^+) \left(\prod_{n=1}^N \Delta Q_n \right)$$

During the first iteration, the orientation estimate, q^- , is initialized by `ecompass`.

Estimate Gravity from Orientation

The gravity vector is interpreted as the third column of the quaternion, q^- , in rotation matrix form:

$$g_{1 \times 3} = (rPrior(:, 3))^T$$

See [1] for an explanation of why the third column of `rPrior` can be interpreted as the gravity vector.

Estimate Gravity from Acceleration

A second gravity vector estimation is made by subtracting the decayed linear acceleration estimate of the previous iteration from the accelerometer readings:

$$gAccel_{1 \times 3} = accelReadings_{1 \times 3} - linAccelPrior_{1 \times 3}$$

Estimate Earth's Magnetic Vector

Earth's magnetic vector is estimated by rotating the magnetic vector estimate from the previous iteration by the *a priori* orientation estimate, in rotation matrix form:

$$mGyro_{1 \times 3} = ((rPrior)(m^T))^T$$

Error Model

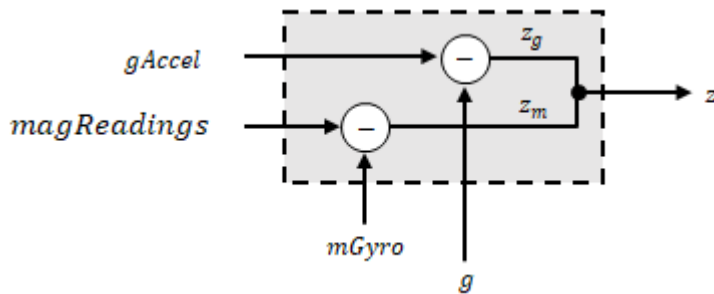

The error model combines two differences:

- The difference between the gravity estimate from the accelerometer readings and the gravity estimate from the gyroscope readings: $z_g = g - gAccel$
- The difference between the magnetic vector estimate from the gyroscope readings and the magnetic vector estimate from the magnetometer: $z_m = mGyro - magReadings$

Magnetometer Correct

The magnetometer correct estimates the error in the magnetic vector estimate and detects magnetic jamming.

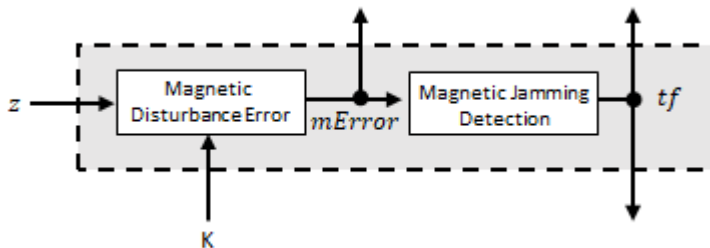

Magnetometer Disturbance Error

The magnetic disturbance error is calculated by matrix multiplication of the Kalman gain associated with the magnetic vector with the error signal:

$$mError_{3 \times 1} = \left((K(10:12, :)_{3 \times 6})(z_{1 \times 6})^T \right)^T$$

The Kalman gain, K , is the Kalman gain calculated in the current iteration.

Magnetic Jamming Detection

Magnetic jamming is determined by verifying that the power of the detected magnetic disturbance is less than or equal to four times the power of the expected magnetic field strength:

$$tf = \begin{cases} \text{true} & \text{if } \sum |mError|^2 > (4)(\text{ExpectedMagneticFieldStrength})^2 \\ \text{false} & \text{else} \end{cases}$$

ExpectedMagneticFieldStrength is a property of `ahrsfilter`.

Kalman Equations

The Kalman equations use the gravity estimate derived from the gyroscope readings, g , the magnetic vector estimate derived from the gyroscope readings, $mGyro$, and the observation of the error process, z , to update the Kalman gain and intermediary covariance matrices. The Kalman gain is applied to the error signal, z , to output an *a posteriori* error estimate, x^+ .

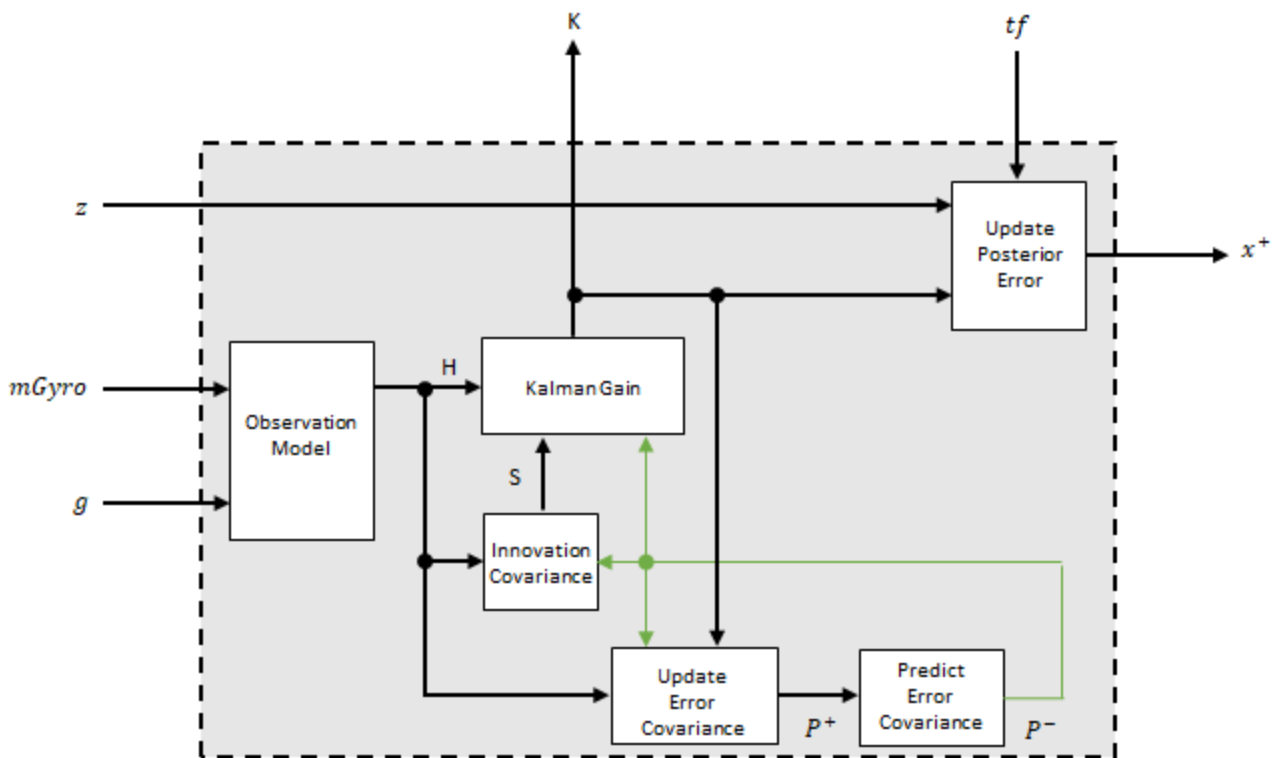

Observation Model

The observation model maps the 1-by-3 observed states, g and $mGyro$, into the 6-by-12 true state, H .

The observation model is constructed as:

$$H_{3 \times 9} = \begin{bmatrix} 0 & g_z & -g_y & 0 & -\kappa g_z & \kappa g_y & 1 & 0 & 0 & 0 & 0 & 0 \\ -g_z & 0 & g_x & \kappa g_z & 0 & -\kappa g_x & 0 & 1 & 0 & 0 & 0 & 0 \\ g_y & -g_x & 0 & -\kappa g_y & \kappa g_x & 0 & 0 & 0 & 1 & 0 & 0 & 0 \\ 0 & m_z & -m_y & 0 & -\kappa m_z & -\kappa m_y & 0 & 0 & 0 & -1 & 0 & 0 \\ -m_z & 0 & m_x & \kappa m_z & 0 & -\kappa m_x & 0 & 0 & 0 & 0 & -1 & 0 \\ m_y & -m_x & 0 & -\kappa m_y & \kappa m_x & 0 & 0 & 0 & 0 & 0 & 0 & -1 \end{bmatrix}$$

where g_x , g_y , and g_z are the x-, y-, and z-elements of the gravity vector estimated from the *a priori* orientation, respectively. m_x , m_y , and m_z are the x-, y-, and z-elements of the magnetic vector estimated from the *a priori* orientation, respectively. κ is a constant determined by the `SampleRate` and `DecimationFactor` properties: $\kappa = \text{DecimationFactor}/\text{SampleRate}$.

See sections 7.3 and 7.4 of [1] for a derivation of the observation model.

Innovation Covariance

The innovation covariance is a 6-by-6 matrix used to track the variability in the measurements. The innovation covariance matrix is calculated as:

$$S_{6 \times 6} = R_{6 \times 6} + (H_{6 \times 12})(P_{12 \times 12}^-)(H_{6 \times 12})^T$$

where

- H is the observation model matrix
- P^- is the predicted (*a priori*) estimate of the covariance of the observation model calculated in the previous iteration
- R is the covariance of the observation model noise, calculated as:

$$R_{6 \times 6} = \begin{bmatrix} accel_{noise} & 0 & 0 & 0 & 0 & 0 \\ 0 & accel_{noise} & 0 & 0 & 0 & 0 \\ 0 & 0 & accel_{noise} & 0 & 0 & 0 \\ 0 & 0 & 0 & mag_{noise} & 0 & 0 \\ 0 & 0 & 0 & 0 & mag_{noise} & 0 \\ 0 & 0 & 0 & 0 & 0 & mag_{noise} \end{bmatrix}$$

where

$$accel_{noise} = \text{AccelerometerNoise} + \text{LinearAccelerationNoise} + \kappa^2 (\text{GyroscopeDriftNoise} + \text{GyroscopeNoise})$$

and

$$mag_{noise} = \text{MagnetometerNoise} + \text{MagneticDisturbanceNoise} + \kappa^2 (\text{GyroscopeDriftNoise} + \text{GyroscopeNoise})$$

The following properties define the observation model noise variance:

- κ -- `DecimationFactor/SampleRate`

- AccelerometerNoise
- LinearAccelerationNoise
- GyroscopeDriftNoise
- GyroscopeNoise
- MagneticDisturbanceNoise
- MagnetometerNoise

Update Error Estimate Covariance

The error estimate covariance is a 12-by-12 matrix used to track the variability in the state.

The error estimate covariance matrix is updated as:

$$P_{12 \times 12}^+ = P_{12 \times 12}^- - (K_{12 \times 6})(H_{6 \times 12})(P_{12 \times 12}^-)$$

where K is the Kalman gain, H is the measurement matrix, and P^- is the error estimate covariance calculated during the previous iteration.

Predict Error Estimate Covariance

The error estimate covariance is a 12-by-12 matrix used to track the variability in the state. The *a priori* error estimate covariance, P^- , is set to the process noise covariance, Q , determined during the previous iteration. Q is calculated as a function of the *a posteriori* error estimate covariance, P^+ . When calculating Q , it is assumed that the cross-correlation terms are negligible compared to the autocorrelation terms, and are set to zero:

$Q =$

$$\begin{array}{cccccc}
 P^+(1) + \kappa^2 P^+(40) + \beta + \eta & 0 & 0 & -\kappa(P^+(40) + \beta) & 0 \\
 0 & P^+(14) + \kappa^2 P^+(53) + \beta + \eta & 0 & 0 & -\kappa(P^+(53) + \beta) \\
 0 & 0 & P^+(27) + \kappa^2 P^+(66) + \beta + \eta & 0 & 0 \\
 -\kappa(P^+(40) + \beta) & 0 & 0 & P^+(40) + \beta & 0 \\
 0 & -\kappa(P^+(53) + \beta) & 0 & 0 & P^+(53) + \beta \\
 0 & 0 & -\kappa(P^+(66) + \beta) & 0 & 0 \\
 0 & 0 & 0 & 0 & 0 \\
 0 & 0 & 0 & 0 & 0 \\
 0 & 0 & 0 & 0 & 0 \\
 0 & 0 & 0 & 0 & 0 \\
 0 & 0 & 0 & 0 & 0 \\
 0 & 0 & 0 & 0 & 0 \\
 0 & 0 & 0 & 0 & 0
 \end{array}$$

where

- P^+ -- is the updated (*a posteriori*) error estimate covariance
- κ -- DecimationFactor/SampleRate
- β -- GyroscopeDriftNoise
- η -- GyroscopeNoise
- ν -- LinearAcclerationDecayFactor
- ξ -- LinearAccelerationNoise
- σ -- MagneticDisturbanceDecayFactor
- γ -- MagneticDisturbanceNoise

See section 10.1 of [1] for a derivation of the terms of the process error matrix.

Kalman Gain

The Kalman gain matrix is a 12-by-6 matrix used to weight the innovation. In this algorithm, the innovation is interpreted as the error process, z .

The Kalman gain matrix is constructed as:

$$K_{12 \times 6} = (P_{12 \times 12}^-)(H_{6 \times 12})^T((S_{6 \times 6})^T)^{-1}$$

where

- P^- -- predicted error covariance
- H -- observation model
- S -- innovation covariance

Update a Posteriori Error

The *a posteriori* error estimate is determined by combining the Kalman gain matrix with the error in the gravity vector and magnetic vector estimations:

$$x_{12 \times 1} = (K_{12 \times 6})(z_{1 \times 6})^T$$

If magnetic jamming is detected in the current iteration, the magnetic vector error signal is ignored, and the *a posteriori* error estimate is calculated as:

$$x_{9 \times 1} = (K(1:9, 1:3))(z_g)^T$$

Correct

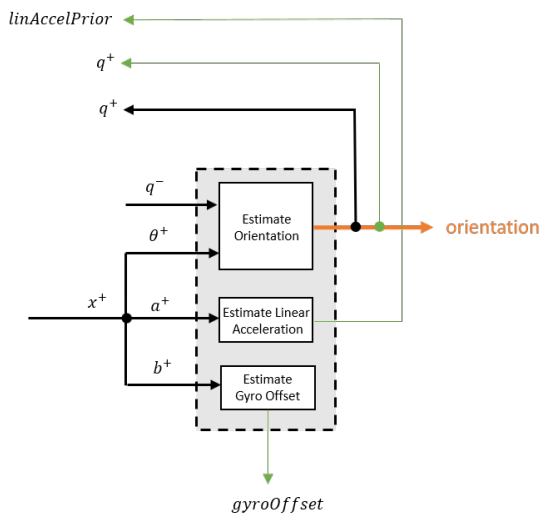

Estimate Orientation

The orientation estimate is updated by multiplying the previous estimation by the error:

$$q^+ = (q^-)(\theta^+)$$

Estimate Linear Acceleration

The linear acceleration estimation is updated by decaying the linear acceleration estimation from the previous iteration and subtracting the error:

$$linAccelPrior = (linAccelPrior_{k-1})\nu - b^+$$

where

- ν -- LinearAccelerationDecayFactor

Estimate Gyroscope Offset

The gyroscope offset estimation is updated by subtracting the gyroscope offset error from the gyroscope offset from the previous iteration:

$$gyroOffset = gyroOffset_{k-1} - a^+$$

Compute Angular Velocity

To estimate angular velocity, the frame of gyroReadings are averaged and the gyroscope offset computed in the previous iteration is subtracted:

$$angularVelocity_{1 \times 3} = \frac{\sum gyroReadings_{N \times 3}}{N} - gyroOffset_{1 \times 3}$$

where N is the decimation factor specified by the DecimationFactor property.

The gyroscope offset estimation is initialized to zeros for the first iteration.

Update Magnetic Vector

If magnetic jamming was not detected in the current iteration, the magnetic vector estimate, m , is updated using the *a posteriori* magnetic disturbance error and the *a posteriori* orientation.

The magnetic disturbance error is converted to the navigation frame:

$$mErrorNED_{1 \times 3} = \left((rPost_{3 \times 3})^T (mError_{1 \times 3})^T \right)^T$$

The magnetic disturbance error in the navigation frame is subtracted from the previous magnetic vector estimate and then interpreted as inclination:

$$M = m - mErrorNED$$

$$inclination = \text{atan2}(M(3), M(1))$$

The inclination is converted to a constrained magnetic vector estimate for the next iteration:

$$m(1) = (\text{ExpectedMagneticFieldStrength})(\cos(\text{inclination}))$$

$$m(2) = 0$$

$$m(3) = (\text{ExpectedMagneticFieldStrength})(\sin(\text{inclination}))$$

ExpectedMagneticFieldStrength is a property of `ahrsfilter`.

References

- [1] Open Source Sensor Fusion. <https://github.com/memsindustrygroup/Open-Source-Sensor-Fusion/tree/master/docs>
- [2] Roetenberg, D., H.J. Luinge, C.T.M. Baten, and P.H. Veltink. "Compensation of Magnetic Disturbances Improves Inertial and Magnetic Sensing of Human Body Segment Orientation." *IEEE Transactions on Neural Systems and Rehabilitation Engineering*. Vol. 13. Issue 3, 2005, pp. 395-405.

Extended Capabilities

C/C++ Code Generation

Generate C and C++ code using MATLAB® Coder™.

Usage notes and limitations:

See "System Objects in MATLAB Code Generation" (MATLAB Coder).

See Also

`ecompass` | `gpsSensor` | `imuSensor` | `imufilter` | `quaternion`

Topics

"Determine Orientation Using Inertial Sensors"

Introduced in R2018b

tune

Tune `ahrsfilter` parameters to reduce estimation error

Syntax

```
tune(filter,sensorData,groundTruth)
tune( ____,config)
```

Description

`tune(filter,sensorData,groundTruth)` adjusts the properties of the `ahrsfilter` filter object, `filter`, to reduce the root-mean-squared (RMS) quaternion distance error between the fused sensor data and the ground truth. The function uses the property values in the filter as the initial estimate for the optimization algorithm.

`tune(____,config)` specifies the tuning configuration based on a `tunerconfig` object, `config`.

Examples

Tune `ahrsfilter` to Improve Orientation Estimate

Load recorded sensor data and ground truth data.

```
ld = load('ahrsfilterTuneData.mat');
qTrue = ld.groundTruth.Orientation; % true orientation
```

Create an `ahrsfilter` object.

```
fuse = ahrsfilter;
```

Fuse the sensor data using the default, untuned filter.

```
qEstUntuned = fuse(ld.sensorData.Accelerometer, ...
    ld.sensorData.Gyroscope, ld.sensorData.Magnetometer);
```

Create a `tunerconfig` object. Tune the `ahrsfilter` object to improve the orientation estimation based on the configuration.

```
config = tunerconfig('ahrsfilter');
tune(fuse,ld.sensorData,ld.groundTruth,config);
```

Iteration	Parameter	Metric
1	AccelerometerNoise	0.1345
1	GyroscopeNoise	0.1342
1	MagnetometerNoise	0.1341
1	GyroscopeDriftNoise	0.1341
1	LinearAccelerationNoise	0.1332
1	MagneticDisturbanceNoise	0.1324
1	LinearAccelerationDecayFactor	0.1317
1	MagneticDisturbanceDecayFactor	0.1316

2	AccelerometerNoise	0.1316
2	GyroscopeNoise	0.1312
2	MagnetometerNoise	0.1311
2	GyroscopeDriftNoise	0.1311
2	LinearAccelerationNoise	0.1300
2	MagneticDisturbanceNoise	0.1292
2	LinearAccelerationDecayFactor	0.1285
2	MagneticDisturbanceDecayFactor	0.1285
3	AccelerometerNoise	0.1285
3	GyroscopeNoise	0.1280
3	MagnetometerNoise	0.1279
3	GyroscopeDriftNoise	0.1279
3	LinearAccelerationNoise	0.1267
3	MagneticDisturbanceNoise	0.1258
3	LinearAccelerationDecayFactor	0.1253
3	MagneticDisturbanceDecayFactor	0.1253
4	AccelerometerNoise	0.1252
4	GyroscopeNoise	0.1247
4	MagnetometerNoise	0.1246
4	GyroscopeDriftNoise	0.1246
4	LinearAccelerationNoise	0.1233
4	MagneticDisturbanceNoise	0.1224
4	LinearAccelerationDecayFactor	0.1220
4	MagneticDisturbanceDecayFactor	0.1220
5	AccelerometerNoise	0.1220
5	GyroscopeNoise	0.1213
5	MagnetometerNoise	0.1212
5	GyroscopeDriftNoise	0.1212
5	LinearAccelerationNoise	0.1200
5	MagneticDisturbanceNoise	0.1190
5	LinearAccelerationDecayFactor	0.1187
5	MagneticDisturbanceDecayFactor	0.1187
6	AccelerometerNoise	0.1187
6	GyroscopeNoise	0.1180
6	MagnetometerNoise	0.1178
6	GyroscopeDriftNoise	0.1178
6	LinearAccelerationNoise	0.1167
6	MagneticDisturbanceNoise	0.1156
6	LinearAccelerationDecayFactor	0.1155
6	MagneticDisturbanceDecayFactor	0.1155
7	AccelerometerNoise	0.1155
7	GyroscopeNoise	0.1147
7	MagnetometerNoise	0.1145
7	GyroscopeDriftNoise	0.1145
7	LinearAccelerationNoise	0.1137
7	MagneticDisturbanceNoise	0.1126
7	LinearAccelerationDecayFactor	0.1125
7	MagneticDisturbanceDecayFactor	0.1125
8	AccelerometerNoise	0.1125
8	GyroscopeNoise	0.1117
8	MagnetometerNoise	0.1116
8	GyroscopeDriftNoise	0.1116
8	LinearAccelerationNoise	0.1112
8	MagneticDisturbanceNoise	0.1100
8	LinearAccelerationDecayFactor	0.1099
8	MagneticDisturbanceDecayFactor	0.1099
9	AccelerometerNoise	0.1099
9	GyroscopeNoise	0.1091

9	MagnetometerNoise	0.1090
9	GyroscopeDriftNoise	0.1090
9	LinearAccelerationNoise	0.1090
9	MagneticDisturbanceNoise	0.1076
9	LinearAccelerationDecayFactor	0.1075
9	MagneticDisturbanceDecayFactor	0.1075
10	AccelerometerNoise	0.1075
10	GyroscopeNoise	0.1066
10	MagnetometerNoise	0.1064
10	GyroscopeDriftNoise	0.1064
10	LinearAccelerationNoise	0.1064
10	MagneticDisturbanceNoise	0.1049
10	LinearAccelerationDecayFactor	0.1047
10	MagneticDisturbanceDecayFactor	0.1047
11	AccelerometerNoise	0.1047
11	GyroscopeNoise	0.1038
11	MagnetometerNoise	0.1036
11	GyroscopeDriftNoise	0.1036
11	LinearAccelerationNoise	0.1036
11	MagneticDisturbanceNoise	0.1016
11	LinearAccelerationDecayFactor	0.1014
11	MagneticDisturbanceDecayFactor	0.1014
12	AccelerometerNoise	0.1014
12	GyroscopeNoise	0.1005
12	MagnetometerNoise	0.1002
12	GyroscopeDriftNoise	0.1002
12	LinearAccelerationNoise	0.1002
12	MagneticDisturbanceNoise	0.0978

Fuse the sensor data using the tuned filter.

```
qEstTuned = fuse(ld.sensorData.Accelerometer, ...
    ld.sensorData.Gyroscope, ld.sensorData.Magnetometer);
```

Compare the tuned and untuned RMS error performances.

```
dUntuned = rad2deg(dist(qEstUntuned, qTrue));
dTuned = rad2deg(dist(qEstTuned, qTrue));
rmsUntuned = sqrt(mean(dUntuned.^2))
```

```
rmsUntuned = 7.7088
```

```
rmsTuned = sqrt(mean(dTuned.^2))
```

```
rmsTuned = 5.6033
```

Visualize the errors with respect to time.

```
N = numel(dUntuned);
t = (0:N-1)./ fuse.SampleRate;
plot(t, dUntuned, 'r', t, dTuned, 'b');
legend('Untuned', 'Tuned');
title('ahrsfilter - Tuned vs Untuned Error')
xlabel('Time (s)');
ylabel('Orientation Error (degrees)');
```

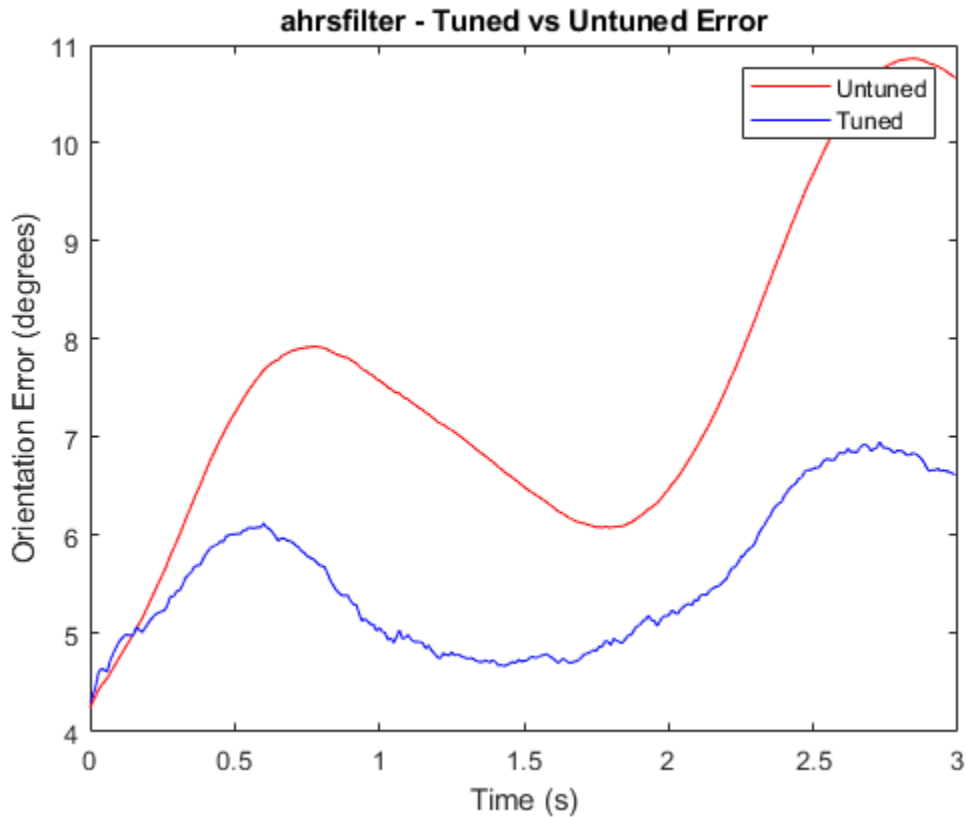

Input Arguments

filter — Filter object

`ahrsfilter` object

Filter object, specified as an `ahrsfilter` object.

sensorData — Sensor data

table

Sensor data, specified as a table. In each row, the sensor data is specified as:

- **Accelerometer** — Accelerometer data, specified as a 1-by-3 vector of scalars in m^2/s .
- **Gyroscope** — Gyroscope data, specified as a 1-by-3 vector of scalars in rad/s .
- **Magnetometer** — Magnetometer data, specified as a 1-by-3 vector of scalars in μT .

If you set the `Cost` property of the tuner configuration input, `config`, to `Custom`, then you can use other data types for the `sensorData` input based on your choice.

groundTruth — Ground truth data

timetable

Ground truth data, specified as a table. The table has only one column of `Orientation` data. In each row, the orientation is specified as a quaternion object or a 3-by-3 rotation matrix.

The function processes each row of the `sensorData` and `groundTruth` tables sequentially to calculate the state estimate and RMS error from the ground truth. Each row of the `sensorData` and the `groundTruth` tables must correspond to each other.

If you set the `Cost` property of the tuner configuration input, `config`, to `Custom`, then you can use other data types for the `groundTruth` input based on your choice.

config – Tuner configuration

`tunerconfig` object

Tuner configuration, specified as a `tunerconfig` object.

References

- [1] Abbeel, P., Coates, A., Montemerlo, M., Ng, A.Y. and Thrun, S. Discriminative Training of Kalman Filters. In *Robotics: Science and systems*, Vol. 2, pp. 1, 2005.

See Also

Introduced in R2020b

complementaryFilter

Orientation estimation from a complementary filter

Description

The `complementaryFilter` System object fuses accelerometer, gyroscope, and magnetometer sensor data to estimate device orientation and angular velocity.

To estimate orientation using this object:

- 1 Create the `complementaryFilter` object and set its properties.
- 2 Call the object with arguments, as if it were a function.

To learn more about how System objects work, see [What Are System Objects?](#).

Creation

Syntax

```
FUSE = complementaryFilter
FUSE = complementaryFilter('ReferenceFrame',RF)
FUSE = complementaryFilter(___,Name,Value)
```

Description

`FUSE = complementaryFilter` returns a `complementaryFilter` System object, `FUSE`, for sensor fusion of accelerometer, gyroscope, and magnetometer data to estimate device orientation and angular velocity.

`FUSE = complementaryFilter('ReferenceFrame',RF)` returns a `complementaryFilter` System object that fuses accelerometer, gyroscope, and magnetometer data to estimate device orientation relative to the reference frame `RF`. Specify `RF` as `'NED'` (North-East-Down) or `'ENU'` (East-North-Up). The default value is `'NED'`.

`FUSE = complementaryFilter(___,Name,Value)` sets each property `Name` to the specified `Value`. Unspecified properties have default values.

Properties

Unless otherwise indicated, properties are *nontunable*, which means you cannot change their values after calling the object. Objects lock when you call them, and the `release` function unlocks them.

If a property is *tunable*, you can change its value at any time.

For more information on changing property values, see [System Design in MATLAB Using System Objects](#).

SampleRate — Input sample rate of sensor data (Hz)

100 (default) | positive scalar

Input sample rate of the sensor data in Hz, specified as a positive scalar.

Tunable: No

Data Types: single | double

AccelerometerGain — Accelerometer gain

0.01 (default) | real scalar in [0, 1]

Accelerometer gain, specified as a real scalar in the range of [0, 1]. The gain determines how much the accelerometer measurement is trusted over the gyroscope measurement for orientation estimation. This property is tunable.

Data Types: single | double

MagnetometerGain — Magnetometer gain

0.01 (default) | real scalar in [0, 1]

Magnetometer gain, specified as a real scalar in the range of [0, 1]. The gain determines how much the magnetometer measurement is trusted over the gyroscope measurement for orientation estimation. This property is tunable.

Data Types: single | double

HasMagnetometer — Enable magnetometer input

true (default) | false

Enable magnetometer input, specified as true or false.

Data Types: logical

OrientationFormat — Output orientation format

'quaternion' (default) | 'Rotation matrix'

Output orientation format, specified as 'quaternion' or 'Rotation matrix'. The size of the output depends on the output orientation format:

- 'quaternion' -- Output is an N -by-1 quaternion.
- 'Rotation matrix' -- Output is a 3-by-3-by- N rotation matrix.

N is the number of samples.

Data Types: char | string

Usage**Syntax**

```
[orientation,angularVelocity] = FUSE(accelReadings,gyroReadings,magReadings)  
[orientation,angularVelocity] = FUSE(accelReadings,gyroReadings)
```

Description

`[orientation,angularVelocity] = FUSE(accelReadings,gyroReadings,magReadings)` fuses accelerometer, gyroscope, and magnetometer data to compute orientation and angular velocity. To use this syntax, set the `HasMagnetometer` property as `true`.

`[orientation,angularVelocity] = FUSE(accelReadings,gyroReadings)` fuses accelerometer and gyroscope data to compute orientation and angular velocity. To use this syntax, set the `HasMagnetometer` property as `false`.

Input Arguments

accelReadings — Accelerometer readings in sensor body coordinate system (m/s²)

N-by-3 matrix

Accelerometer readings in the sensor body coordinate system in m/s², specified as an *N*-by-3 matrix. *N* is the number of samples, and the three columns of `accelReadings` represent the `[x y z]` measurements. Accelerometer readings are assumed to correspond to the sample rate specified by the `SampleRate` property. In the filter, the gravity constant *g* is assumed to be 9.81 m/s².

Data Types: `single` | `double`

gyroReadings — Gyroscope readings in sensor body coordinate system (rad/s)

N-by-3 matrix

Gyroscope readings in the sensor body coordinate system in rad/s, specified as an *N*-by-3 matrix. *N* is the number of samples, and the three columns of `gyroReadings` represent the `[x y z]` measurements. Gyroscope readings are assumed to correspond to the sample rate specified by the `SampleRate` property.

Data Types: `single` | `double`

magReadings — Magnetometer readings in sensor body coordinate system (μT)

N-by-3 matrix

Magnetometer readings in the sensor body coordinate system in μT, specified as an *N*-by-3 matrix. *N* is the number of samples, and the three columns of `magReadings` represent the `[x y z]` measurements. Magnetometer readings are assumed to correspond to the sample rate specified by the `SampleRate` property.

Data Types: `single` | `double`

Output Arguments

orientation — Orientation that rotates quantities from local navigation coordinate system to sensor body coordinate system

N-by-1 array of quaternions (default) | 3-by-3-by-*N* array

Orientation that rotates quantities from the local navigation coordinate system to the body coordinate system, returned as quaternions or an array. The size and type of `orientation` depends on whether the `OrientationFormat` property is set to `'quaternion'` or `'Rotation matrix'`:

- `'quaternion'` -- the output is an *N*-by-1 vector of quaternions, where *N* is the number of samples.
- `'Rotation matrix'` -- the output is a 3-by-3-by-*N* array of rotation matrices, where *N* is the number of samples.

Data Types: quaternion | single | double

angularVelocity — Angular velocity in sensor body coordinate system (rad/s)

N-by-3 array (default)

Angular velocity expressed in the sensor body coordinate system in rad/s, returned as an *N*-by-3 array, where *N* is the number of samples.

Data Types: single | double

Object Functions

To use an object function, specify the System object as the first input argument. For example, to release system resources of a System object named `obj`, use this syntax:

```
release(obj)
```

Common to All System Objects

<code>step</code>	Run System object algorithm
<code>release</code>	Release resources and allow changes to System object property values and input characteristics
<code>reset</code>	Reset internal states of System object
<code>clone</code>	Create duplicate System object
<code>isLocked</code>	Determine if System object is in use

Examples

Estimate Orientation from Recorded IMU Data

Load the `rpy_9axis` file, which contains recorded accelerometer, gyroscope, and magnetometer sensor data from a device oscillating in pitch (around *y*-axis), then yaw (around *z*-axis), and then roll (around *x*-axis). The file also contains the sample rate of the recording.

```
ld = load('rpy_9axis.mat');  
accel = ld.sensorData.Acceleration;  
gyro = ld.sensorData.AngularVelocity;  
mag = ld.sensorData.MagneticField;
```

Create a complementary filter object with sample rate equal to the frequency of the data.

```
Fs = ld.Fs; % Hz  
fuse = complementaryFilter('SampleRate', Fs);
```

Fuse accelerometer, gyroscope, and magnetometer data using the filter.

```
q = fuse(accel, gyro, mag);
```

Visualize the results.

```
plot(eulerd(q, 'ZYX', 'frame'));  
title('Orientation Estimate');  
legend('Z-rotation', 'Y-rotation', 'X-rotation');  
ylabel('Degrees');
```

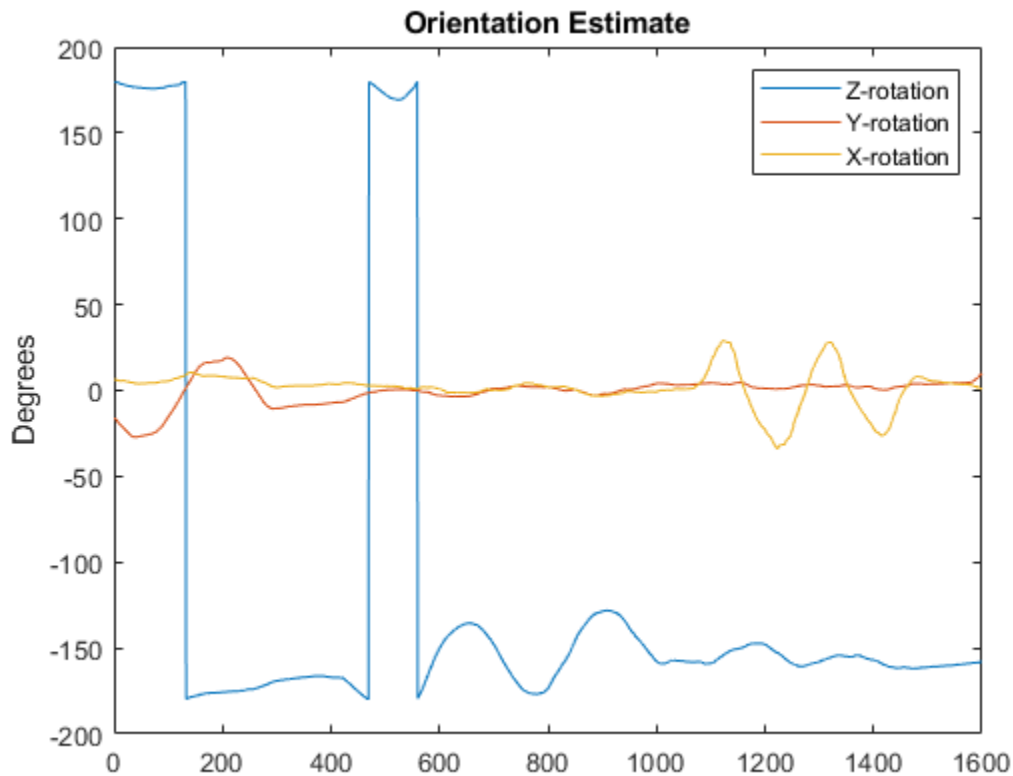

References

- [1] Valenti, R., I. Dryanovski, and J. Xiao. "Keeping a good attitude: A quaternion-based orientation filter for IMUs and MARGs." *Sensors*. Vol. 15, Number 8, 2015, pp. 19302-19330.

Extended Capabilities

C/C++ Code Generation

Generate C and C++ code using MATLAB® Coder™.

See Also

`ahrsfilter` | `imufilter`

Introduced in R2019b

imufilter

Orientation from accelerometer and gyroscope readings

Description

The `imufilter` System object fuses accelerometer and gyroscope sensor data to estimate device orientation.

To estimate device orientation:

- 1 Create the `imufilter` object and set its properties.
- 2 Call the object with arguments, as if it were a function.

To learn more about how System objects work, see [What Are System Objects?](#).

Creation

Syntax

```
FUSE = imufilter
FUSE = imufilter('ReferenceFrame',RF)
FUSE = imufilter(___,Name,Value)
```

Description

`FUSE = imufilter` returns an indirect Kalman filter System object, `FUSE`, for fusion of accelerometer and gyroscope data to estimate device orientation. The filter uses a nine-element state vector to track error in the orientation estimate, the gyroscope bias estimate, and the linear acceleration estimate.

`FUSE = imufilter('ReferenceFrame',RF)` returns an `imufilter` filter System object that fuses accelerometer and gyroscope data to estimate device orientation relative to the reference frame `RF`. Specify `RF` as `'NED'` (North-East-Down) or `'ENU'` (East-North-Up). The default value is `'NED'`.

`FUSE = imufilter(___,Name,Value)` sets each property `Name` to the specified `Value`. Unspecified properties have default values.

Example: `FUSE = imufilter('SampleRate',200,'GyroscopeNoise',1e-6)` creates a System object, `FUSE`, with a 200 Hz sample rate and gyroscope noise set to 1e-6 radians per second squared.

Properties

Unless otherwise indicated, properties are *nontunable*, which means you cannot change their values after calling the object. Objects lock when you call them, and the `release` function unlocks them.

If a property is *tunable*, you can change its value at any time.

For more information on changing property values, see System Design in MATLAB Using System Objects.

SampleRate — Sample rate of input sensor data (Hz)

100 (default) | positive finite scalar

Sample rate of the input sensor data in Hz, specified as a positive finite scalar.

Tunable: No

Data Types: single | double | uint8 | uint16 | uint32 | uint64 | int8 | int16 | int32 | int64

DecimationFactor — Decimation factor

1 (default) | positive integer scalar

Decimation factor by which to reduce the sample rate of the input sensor data, specified as a positive integer scalar.

The number of rows of the inputs, `accelReadings` and `gyroReadings`, must be a multiple of the decimation factor.

Tunable: No

Data Types: single | double | uint8 | uint16 | uint32 | uint64 | int8 | int16 | int32 | int64

AccelerometerNoise — Variance of accelerometer signal noise ((m/s²)²)

0.00019247 (default) | positive real scalar

Variance of accelerometer signal noise in (m/s²)², specified as a positive real scalar.

Tunable: Yes

Data Types: single | double | uint8 | uint16 | uint32 | uint64 | int8 | int16 | int32 | int64

GyroscopeNoise — Variance of gyroscope signal noise ((rad/s)²)

9.1385e-5 (default) | positive real scalar

Variance of gyroscope signal noise in (rad/s)², specified as a positive real scalar.

Tunable: Yes

Data Types: single | double | uint8 | uint16 | uint32 | uint64 | int8 | int16 | int32 | int64

GyroscopeDriftNoise — Variance of gyroscope offset drift ((rad/s)²)

3.0462e-13 (default) | positive real scalar

Variance of gyroscope offset drift in (rad/s)², specified as a positive real scalar.

Tunable: Yes

Data Types: single | double | uint8 | uint16 | uint32 | uint64 | int8 | int16 | int32 | int64

LinearAccelerationNoise — Variance of linear acceleration noise ((m/s²)²)

0.0096236 (default) | positive real scalar

Variance of linear acceleration noise in (m/s²)², specified as a positive real scalar. Linear acceleration is modeled as a lowpass filtered white noise process.

Tunable: Yes

Data Types: single | double | uint8 | uint16 | uint32 | uint64 | int8 | int16 | int32 | int64

LinearAccelerationDecayFactor — Decay factor for linear acceleration drift

0.5 (default) | scalar in the range [0,1]

Decay factor for linear acceleration drift, specified as a scalar in the range [0,1]. If linear acceleration is changing quickly, set `LinearAccelerationDecayFactor` to a lower value. If linear acceleration changes slowly, set `LinearAccelerationDecayFactor` to a higher value. Linear acceleration drift is modeled as a lowpass-filtered white noise process.

Tunable: Yes

Data Types: single | double | uint8 | uint16 | uint32 | uint64 | int8 | int16 | int32 | int64

InitialProcessNoise — Covariance matrix for process noise

9-by-9 matrix

Covariance matrix for process noise, specified as a 9-by-9 matrix. The default is:

```
Columns 1 through 6
0.000006092348396      0      0      0      0      0
0      0.000006092348396      0      0      0      0
0      0      0.000006092348396      0      0      0
0      0      0      0.000076154354947      0      0
0      0      0      0      0.000076154354947      0
0      0      0      0      0      0.000076154354947
0      0      0      0      0      0      0.000076154354947
0      0      0      0      0      0      0
0      0      0      0      0      0      0

Columns 7 through 9
0      0      0
0      0      0
0      0      0
0      0      0
0      0      0
0.009623610000000      0      0
0      0.009623610000000      0
0      0      0.009623610000000
```

The initial process covariance matrix accounts for the error in the process model.

Data Types: single | double | uint8 | uint16 | uint32 | uint64 | int8 | int16 | int32 | int64

OrientationFormat — Output orientation format

'quaternion' (default) | 'Rotation matrix'

Output orientation format, specified as 'quaternion' or 'Rotation matrix'. The size of the output depends on the input size, *N*, and the output orientation format:

- 'quaternion' -- Output is an *N*-by-1 quaternion.
- 'Rotation matrix' -- Output is a 3-by-3-by-*N* rotation matrix.

Data Types: char | string

Usage

Syntax

```
[orientation,angularVelocity] = FUSE(accelReadings,gyroReadings)
```

Description

`[orientation,angularVelocity] = FUSE(accelReadings,gyroReadings)` fuses accelerometer and gyroscope readings to compute orientation and angular velocity measurements. The algorithm assumes that the device is stationary before the first call.

Input Arguments

accelReadings — Accelerometer readings in sensor body coordinate system (m/s²)

N-by-3 matrix

Accelerometer readings in the sensor body coordinate system in m/s², specified as an *N*-by-3 matrix. *N* is the number of samples, and the three columns of `accelReadings` represent the [x y z] measurements. Accelerometer readings are assumed to correspond to the sample rate specified by the `SampleRate` property.

Data Types: `single` | `double`

gyroReadings — Gyroscope readings in sensor body coordinate system (rad/s)

N-by-3 matrix

Gyroscope readings in the sensor body coordinate system in rad/s, specified as an *N*-by-3 matrix. *N* is the number of samples, and the three columns of `gyroReadings` represent the [x y z] measurements. Gyroscope readings are assumed to correspond to the sample rate specified by the `SampleRate` property.

Data Types: `single` | `double`

Output Arguments

orientation — Orientation that rotates quantities from global coordinate system to sensor body coordinate system

M-by-1 vector of quaternions (default) | 3-by-3-by-*M* array

Orientation that can rotate quantities from a global coordinate system to a body coordinate system, returned as quaternions or an array. The size and type of `orientation` depends on whether the `OrientationFormat` property is set to `'quaternion'` or `'Rotation matrix'`:

- `'quaternion'` -- The output is an *M*-by-1 vector of quaternions, with the same underlying data type as the inputs.
- `'Rotation matrix'` -- The output is a 3-by-3-by-*M* array of rotation matrices the same data type as the inputs.

The number of input samples, *N*, and the `DecimationFactor` property determine *M*.

You can use `orientation` in a `rotateframe` function to rotate quantities from a global coordinate system to a sensor body coordinate system.

Data Types: `quaternion` | `single` | `double`

angularVelocity — Angular velocity in sensor body coordinate system (rad/s)

M-by-3 array (default)

Angular velocity with gyroscope bias removed in the sensor body coordinate system in rad/s, returned as an *M*-by-3 array. The number of input samples, *N*, and the DecimationFactor property determine *M*.

Data Types: `single` | `double`

Object Functions

To use an object function, specify the System object as the first input argument. For example, to release system resources of a System object named `obj`, use this syntax:

```
release(obj)
```

Specific to `imufilter`

`tune` Tune `imufilter` parameters to reduce estimation error

Common to All System Objects

`step` Run System object algorithm
`release` Release resources and allow changes to System object property values and input characteristics
`reset` Reset internal states of System object

Examples**Estimate Orientation from IMU data**

Load the `rpy_9axis` file, which contains recorded accelerometer, gyroscope, and magnetometer sensor data from a device oscillating in pitch (around *y*-axis), then yaw (around *z*-axis), and then roll (around *x*-axis). The file also contains the sample rate of the recording.

```
load 'rpy_9axis.mat' sensorData Fs
```

```
accelerometerReadings = sensorData.Acceleration;  
gyroscopeReadings = sensorData.AngularVelocity;
```

Create an `imufilter` System object™ with sample rate set to the sample rate of the sensor data. Specify a decimation factor of two to reduce the computational cost of the algorithm.

```
decim = 2;  
fuse = imufilter('SampleRate',Fs,'DecimationFactor',decim);
```

Pass the accelerometer readings and gyroscope readings to the `imufilter` object, `fuse`, to output an estimate of the sensor body orientation over time. By default, the orientation is output as a vector of quaternions.

```
q = fuse(accelerometerReadings,gyroscopeReadings);
```

Orientation is defined by the angular displacement required to rotate a parent coordinate system to a child coordinate system. Plot the orientation in Euler angles in degrees over time.

`imufilter` fusion correctly estimates the change in orientation from an assumed north-facing initial orientation. However, the device's x-axis was pointing southward when recorded. To correctly estimate the orientation relative to the true initial orientation or relative to NED, use `ahrsfilter`.

```
time = (0:decim:size(accelerometerReadings,1)-1)/Fs;
```

```
plot(time,eulder(q,'ZYX','frame'))
title('Orientation Estimate')
legend('Z-axis', 'Y-axis', 'X-axis')
xlabel('Time (s)')
ylabel('Rotation (degrees)')
```

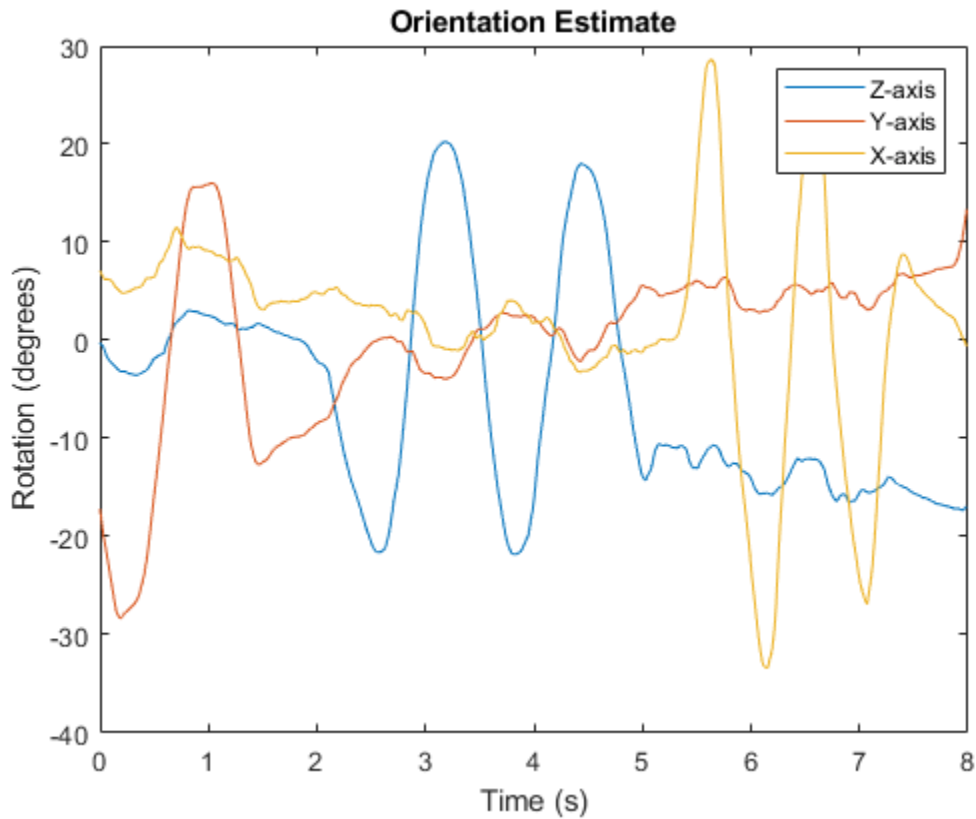

Model Tilt Using Gyroscope and Accelerometer Readings

Model a tilting IMU that contains an accelerometer and gyroscope using the `imuSensor System object™`. Use ideal and realistic models to compare the results of orientation tracking using the `imufilter System object`.

Load a struct describing ground-truth motion and a sample rate. The motion struct describes sequential rotations:

- 1 yaw: 120 degrees over two seconds
- 2 pitch: 60 degrees over one second

- 3** roll: 30 degrees over one-half second
- 4** roll: -30 degrees over one-half second
- 5** pitch: -60 degrees over one second
- 6** yaw: -120 degrees over two seconds

In the last stage, the motion struct combines the 1st, 2nd, and 3rd rotations into a single-axis rotation. The acceleration, angular velocity, and orientation are defined in the local NED coordinate system.

```
load y120p60r30.mat motion fs
accNED = motion.Acceleration;
angVelNED = motion.AngularVelocity;
orientationNED = motion.Orientation;

numSamples = size(motion.Orientation,1);
t = (0:(numSamples-1)).'/fs;
```

Create an ideal IMU sensor object and a default IMU filter object.

```
IMU = imuSensor('accel-gyro','SampleRate',fs);
aFilter = imufilter('SampleRate',fs);
```

In a loop:

- 1** Simulate IMU output by feeding the ground-truth motion to the IMU sensor object.
- 2** Filter the IMU output using the default IMU filter object.

```
orientation = zeros(numSamples,1,'quaternion');
for i = 1:numSamples

    [accelBody,gyroBody] = IMU(accNED(i,:),angVelNED(i,:),orientationNED(i,:));

    orientation(i) = aFilter(accelBody,gyroBody);

end
release(aFilter)
```

Plot the orientation over time.

```
figure(1)
plot(t,eulerd(orientation,'ZYX','frame'))
xlabel('Time (s)')
ylabel('Rotation (degrees)')
title('Orientation Estimation -- Ideal IMU Data, Default IMU Filter')
legend('Z-axis','Y-axis','X-axis')
```

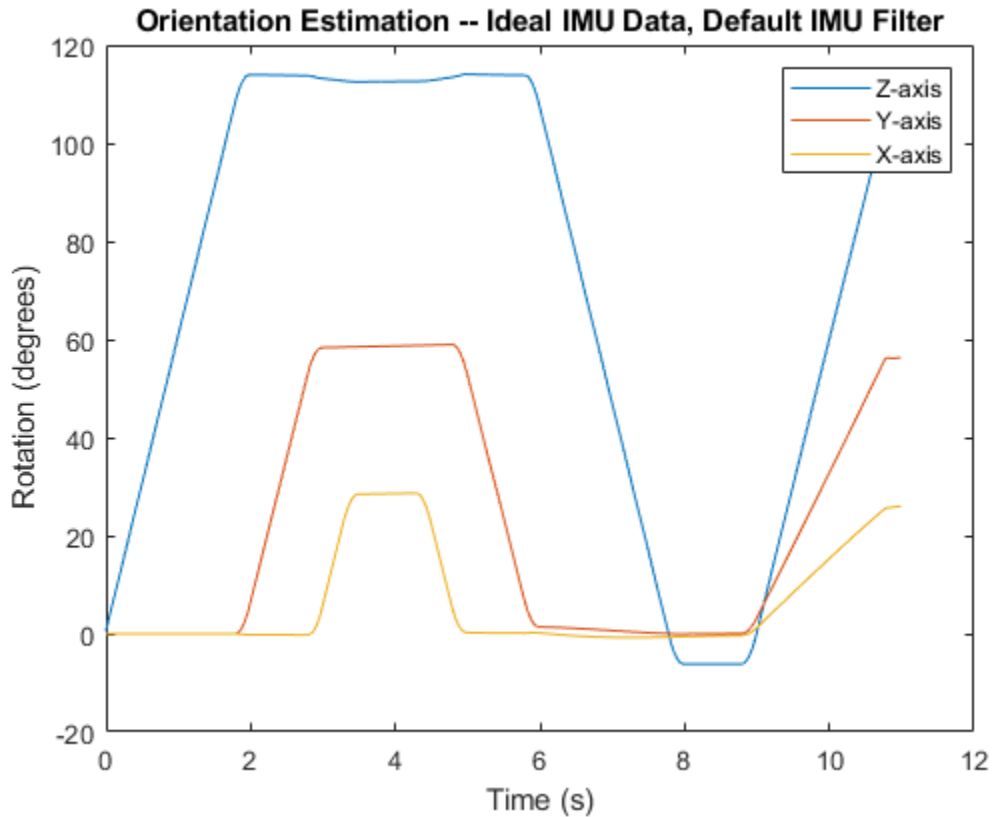

Modify properties of your `imuSensor` to model real-world sensors. Run the loop again and plot the orientation estimate over time.

```

IMU.Accelerometer = accelparams( ...
    'MeasurementRange',19.62, ...
    'Resolution',0.00059875, ...
    'ConstantBias',0.4905, ...
    'AxesMisalignment',2, ...
    'NoiseDensity',0.003924, ...
    'BiasInstability',0, ...
    'TemperatureBias', [0.34335 0.34335 0.5886], ...
    'TemperatureScaleFactor',0.02);
IMU.Gyroscope = gyroparams( ...
    'MeasurementRange',4.3633, ...
    'Resolution',0.00013323, ...
    'AxesMisalignment',2, ...
    'NoiseDensity',8.7266e-05, ...
    'TemperatureBias',0.34907, ...
    'TemperatureScaleFactor',0.02, ...
    'AccelerationBias',0.00017809, ...
    'ConstantBias',[0.3491,0.5,0]);

orientationDefault = zeros(numSamples,1,'quaternion');
for i = 1:numSamples

    [accelBody,gyroBody] = IMU(accNED(i,:),angVelNED(i,:),orientationNED(i,:));

```

```

orientationDefault(i) = aFilter(accelBody,gyroBody);
end
release(aFilter)

figure(2)
plot(t,eulerd(orientationDefault,'ZYX','frame'))
xlabel('Time (s)')
ylabel('Rotation (degrees)')
title('Orientation Estimation -- Realistic IMU Data, Default IMU Filter')
legend('Z-axis','Y-axis','X-axis')

```

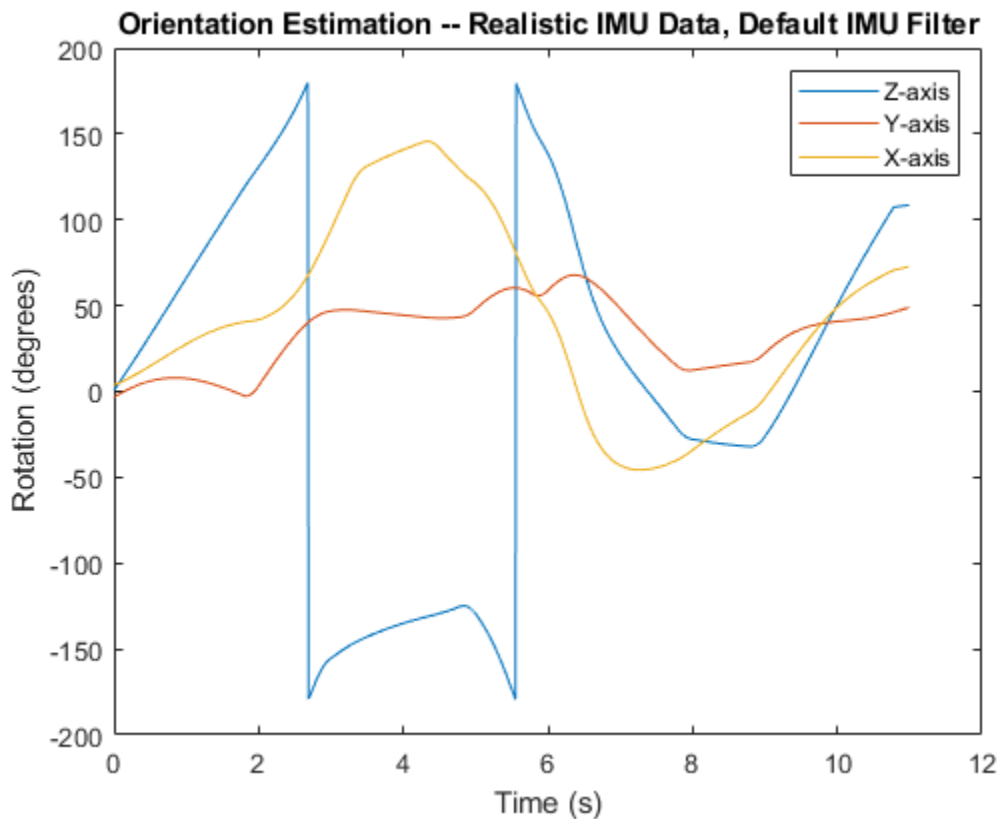

The ability of the `imufilter` to track the ground-truth data is significantly reduced when modeling a realistic IMU. To improve performance, modify properties of your `imufilter` object. These values were determined empirically. Run the loop again and plot the orientation estimate over time.

```

aFilter.GyroscopeNoise          = 7.6154e-7;
aFilter.AccelerometerNoise      = 0.0015398;
aFilter.GyroscopeDriftNoise     = 3.0462e-12;
aFilter.LinearAccelerationNoise = 0.00096236;
aFilter.InitialProcessNoise     = aFilter.InitialProcessNoise*10;

orientationNondefault = zeros(numSamples,1,'quaternion');
for i = 1:numSamples
    [accelBody,gyroBody] = IMU(accNED(i,:),angVelNED(i,:),orientationNED(i,:));

    orientationNondefault(i) = aFilter(accelBody,gyroBody);
end

```

```

end
release(aFilter)

figure(3)
plot(t,eulerd(orientationNondefault,'ZYX','frame'))
xlabel('Time (s)')
ylabel('Rotation (degrees)')
title('Orientation Estimation -- Realistic IMU Data, Nondefault IMU Filter')
legend('Z-axis','Y-axis','X-axis')

```

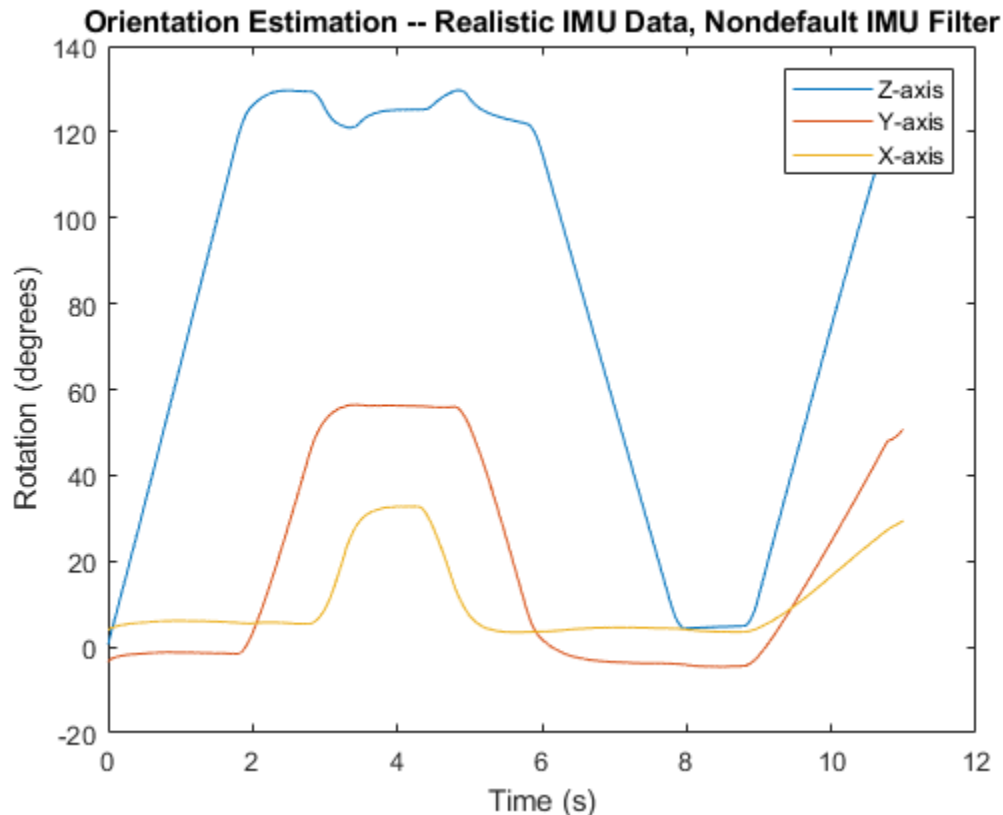

To quantify the improved performance of the modified `imufilter`, plot the quaternion distance between the ground-truth motion and the orientation as returned by the `imufilter` with default and nondefault properties.

```

qDistDefault = rad2deg(dist(orientationNED,orientationDefault));
qDistNondefault = rad2deg(dist(orientationNED,orientationNondefault));

```

```

figure(4)
plot(t,[qDistDefault,qDistNondefault])
title('Quaternion Distance from True Orientation')
legend('Realistic IMU Data, Default IMU Filter', ...
'Realistic IMU Data, Nondefault IMU Filter')
xlabel('Time (s)')
ylabel('Quaternion Distance (degrees)')

```

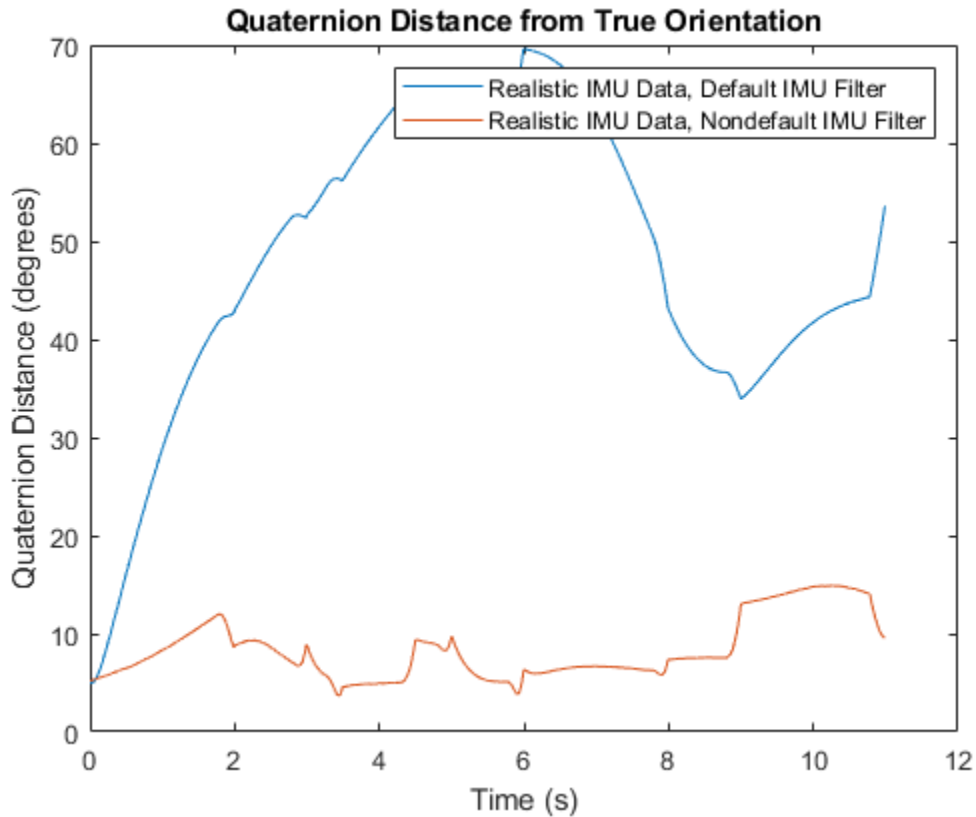

Remove Bias from Angular Velocity Measurement

This example shows how to remove gyroscope bias from an IMU using `imufilter`.

Use `kinematicTrajectory` to create a trajectory with two parts. The first part has a constant angular velocity about the *y*- and *z*-axes. The second part has a varying angular velocity in all three axes.

```
duration = 60*8;
fs = 20;
numSamples = duration * fs;
rng('default') % Seed the RNG to reproduce noisy sensor measurements.

initialAngVel = [0,0.5,0.25];
finalAngVel = [-0.2,0.6,0.5];
constantAngVel = repmat(initialAngVel,floor(numSamples/2),1);
varyingAngVel = [linspace(initialAngVel(1), finalAngVel(1), ceil(numSamples/2)).', ...
                linspace(initialAngVel(2), finalAngVel(2), ceil(numSamples/2)).', ...
                linspace(initialAngVel(3), finalAngVel(3), ceil(numSamples/2)).'];

angVelBody = [constantAngVel; varyingAngVel];
accBody = zeros(numSamples,3);

traj = kinematicTrajectory('SampleRate',fs);

[~,qNED,~,accNED,angVelNED] = traj(accBody,angVelBody);
```

Create an `imuSensor System` object™, `IMU`, with a nonideal gyroscope. Call `IMU` with the ground-truth acceleration, angular velocity, and orientation.

```
IMU = imuSensor('accel-gyro', ...
    'Gyroscope',gyroparams('RandomWalk',0.003,'ConstantBias',0.3), ...
    'SampleRate',fs);
```

```
[accelReadings, gyroReadingsBody] = IMU(accNED,angVelNED,qNED);
```

Create an `imufilter System` object, `fuse`. Call `fuse` with the modeled accelerometer readings and gyroscope readings.

```
fuse = imufilter('SampleRate',fs, 'GyroscopeDriftNoise', 1e-6);
```

```
[~,angVelBodyRecovered] = fuse(accelReadings,gyroReadingsBody);
```

Plot the ground-truth angular velocity, the gyroscope readings, and the recovered angular velocity for each axis.

The angular velocity returned from the `imufilter` compensates for the effect of the gyroscope bias over time and converges to the true angular velocity.

```
time = (0:numSamples-1)/fs;

figure(1)
plot(time,angVelBody(:,1), ...
    time,gyroReadingsBody(:,1), ...
    time,angVelBodyRecovered(:,1))
title('X-axis')
legend('True Angular Velocity', ...
    'Gyroscope Readings', ...
    'Recovered Angular Velocity')
ylabel('Angular Velocity (rad/s)')
```

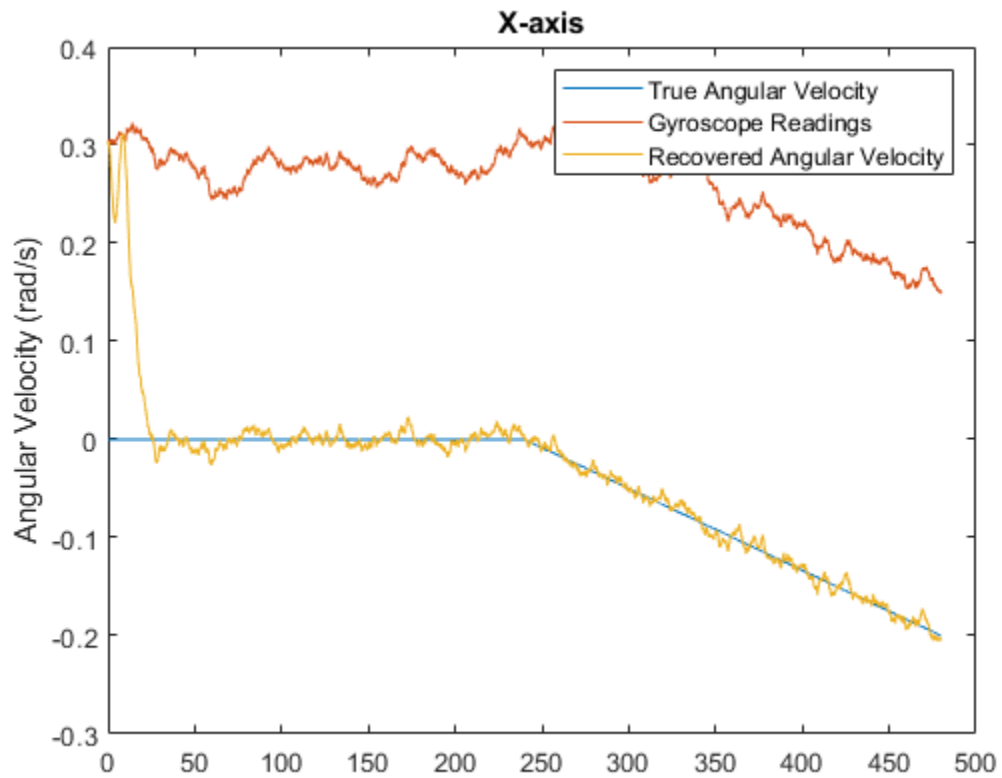

```
figure(2)
plot(time,angVelBody(:,2), ...
      time,gyroReadingsBody(:,2), ...
      time,angVelBodyRecovered(:,2))
title('Y-axis')
ylabel('Angular Velocity (rad/s)')
```

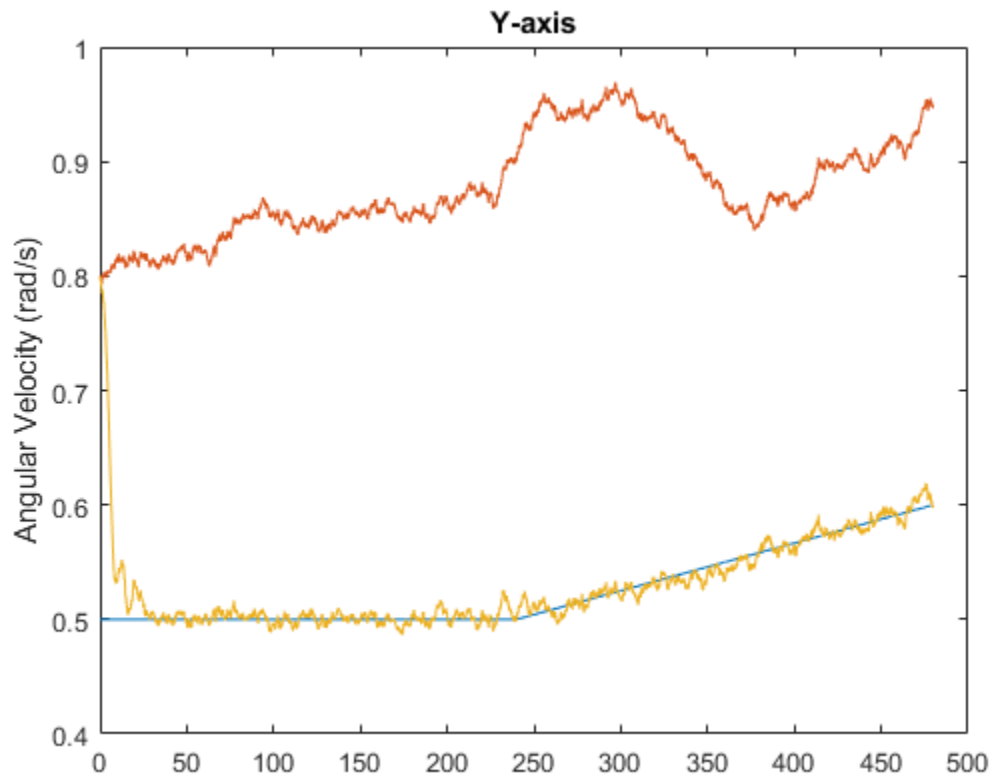

```
figure(3)
plot(time,angVelBody(:,3), ...
      time,gyroReadingsBody(:,3), ...
      time,angVelBodyRecovered(:,3))
title('Z-axis')
ylabel('Angular Velocity (rad/s)')
xlabel('Time (s)')
```

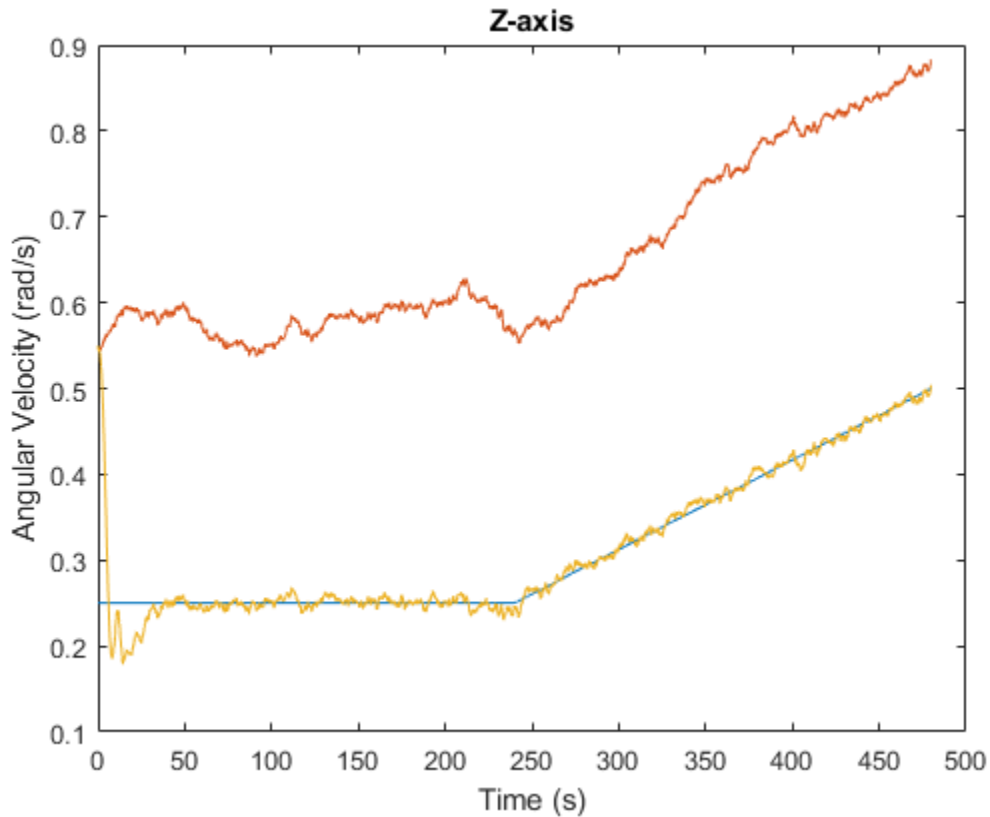

Algorithms

Note: The following algorithm only applies to an NED reference frame.

The `imufilter` uses the six-axis Kalman filter structure described in [1]. The algorithm attempts to track the errors in orientation, gyroscope offset, and linear acceleration to output the final orientation and angular velocity. Instead of tracking the orientation directly, the indirect Kalman filter models the error process, x , with a recursive update:

$$x_k = \begin{bmatrix} \theta_k \\ b_k \\ a_k \end{bmatrix} = F_k \begin{bmatrix} \theta_{k-1} \\ b_{k-1} \\ a_{k-1} \end{bmatrix} + w_k$$

where x_k is a 9-by-1 vector consisting of:

- θ_k -- 3-by-1 orientation error vector, in degrees, at time k
- b_k -- 3-by-1 gyroscope zero angular rate bias vector, in deg/s, at time k
- a_k -- 3-by-1 acceleration error vector measured in the sensor frame, in g, at time k
- w_k -- 9-by-1 additive noise vector
- F_k -- state transition model

Because x_k is defined as the error process, the *a priori* estimate is always zero, and therefore the state transition model, F_k , is zero. This insight results in the following reduction of the standard Kalman equations:

Standard Kalman equations:

$$\begin{aligned}x_k^- &= F_k x_{k-1}^+ \\P_k^- &= F_k P_{k-1}^+ F_k^T + Q_k \\y_k &= z_k - H_k x_k^- \\S_k &= R_k + H_k P_k^- H_k^T \\K_k &= P_k^- H_k^T (S_k)^{-1} \\x_k^+ &= x_k^- + K_k y_k \\P_k^+ &= P_k^- - K_k H_k P_k^-\end{aligned}$$

Kalman equations used in this algorithm:

$$\begin{aligned}x_k^- &= 0 \\P_k^- &= Q_k \\y_k &= z_k \\S_k &= R_k + H_k P_k^- H_k^T \\K_k &= P_k^- H_k^T (S_k)^{-1} \\x_k^+ &= K_k y_k \\P_k^+ &= P_k^- - K_k H_k P_k^-\end{aligned}$$

where

- x_k^- -- predicted (*a priori*) state estimate; the error process
- P_k^- -- predicted (*a priori*) estimate covariance
- y_k -- innovation
- S_k -- innovation covariance
- K_k -- Kalman gain
- x_k^+ -- updated (*a posteriori*) state estimate
- P_k^+ -- updated (*a posteriori*) estimate covariance

k represents the iteration, the superscript $+$ represents an *a posteriori* estimate, and the superscript $-$ represents an *a priori* estimate.

The graphic and following steps describe a single frame-based iteration through the algorithm.

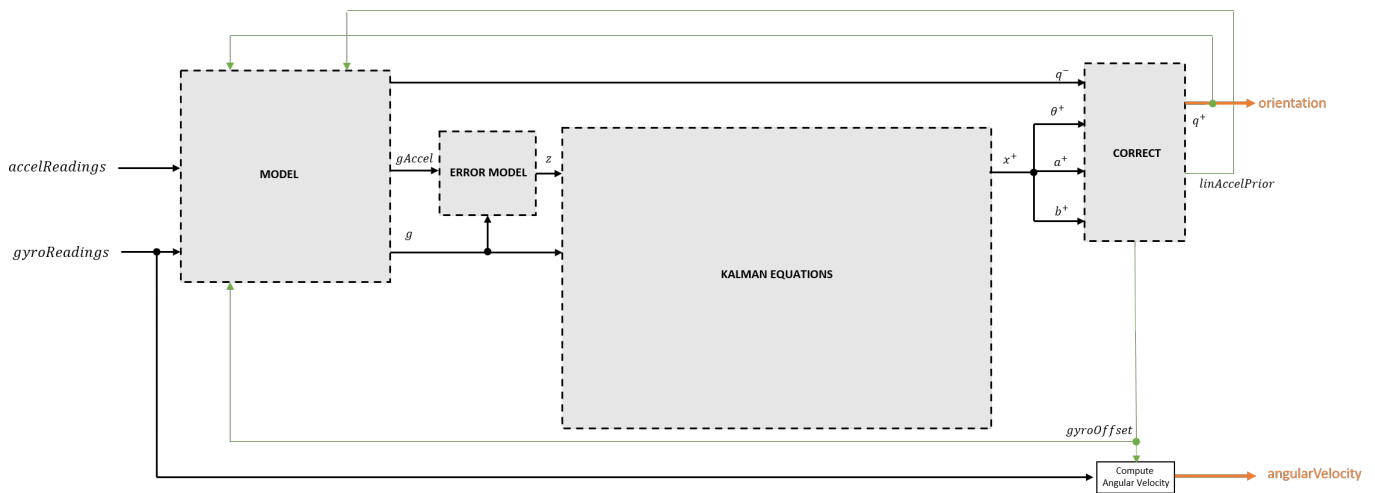

Before the first iteration, the `accelReadings` and `gyroReadings` inputs are chunked into 1-by-3 frames and `DecimationFactor`-by-3 frames, respectively. The algorithm uses the most current accelerometer readings corresponding to the chunk of gyroscope readings.

Detailed Overview

Step through the algorithm for an explanation of each stage of the detailed overview.

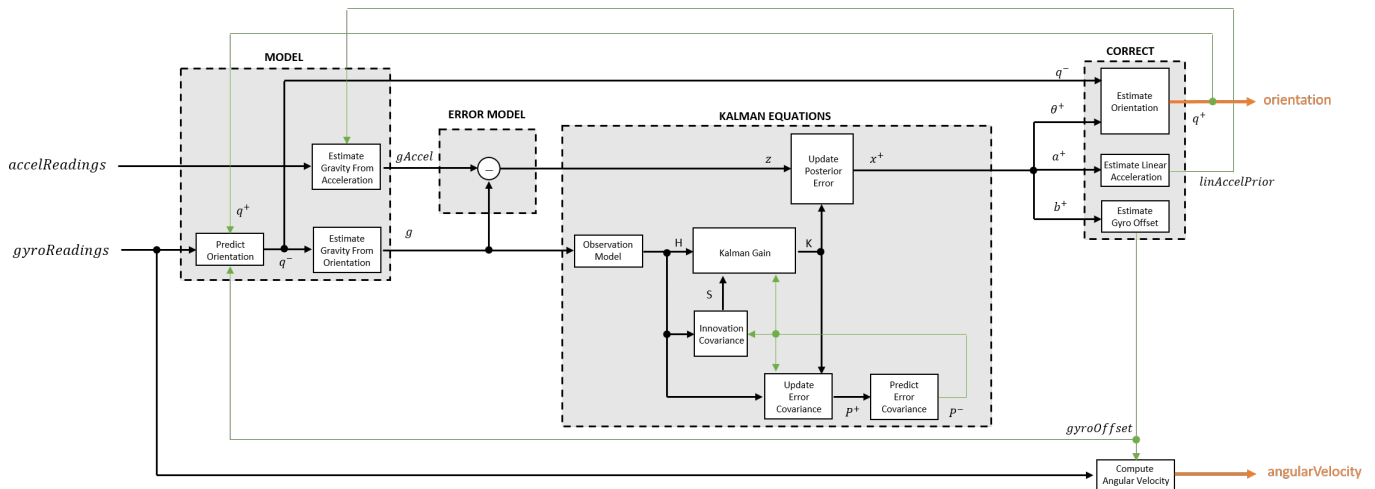

Model

The algorithm models acceleration and angular change as linear processes.

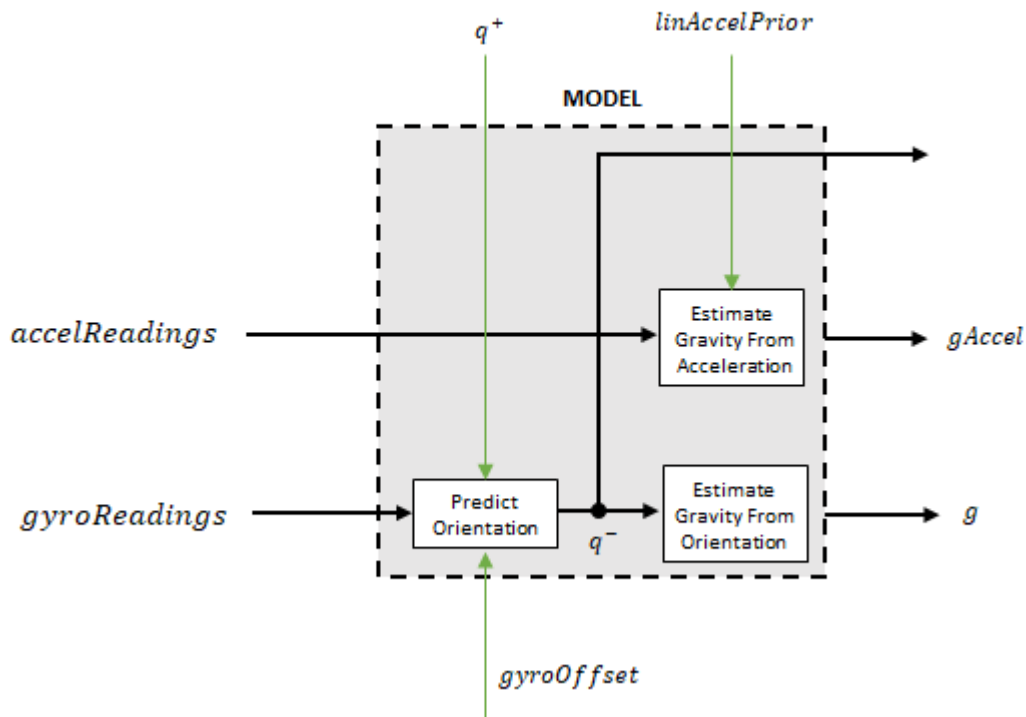

Predict Orientation

The orientation for the current frame is predicted by first estimating the angular change from the previous frame:

$$\Delta\varphi_{N \times 3} = \frac{(\text{gyroReadings}_{N \times 3} - \text{gyroOffset}_{1 \times 3})}{fs}$$

where N is the decimation factor specified by the `DecimationFactor` property, and fs is the sample rate specified by the `SampleRate` property.

The angular change is converted into quaternions using the `rotvec` quaternion construction syntax:

$$\Delta Q_{N \times 1} = \text{quaternion}(\Delta\varphi_{N \times 3}, 'rotvec')$$

The previous orientation estimate is updated by rotating it by ΔQ :

$$q_{1 \times 1}^- = (q_{1 \times 1}^+) \left(\prod_{n=1}^N \Delta Q_n \right)$$

During the first iteration, the orientation estimate, q^- , is initialized by `ecompass` with an assumption that the x -axis points north.

Estimate Gravity from Orientation

The gravity vector is interpreted as the third column of the quaternion, q^- , in rotation matrix form:

$$g_{1 \times 3} = (rPrior(:, 3))^T$$

See `ecompass` for an explanation of why the third column of `rPrior` can be interpreted as the gravity vector.

Estimate Gravity from Acceleration

A second gravity vector estimation is made by subtracting the decayed linear acceleration estimate of the previous iteration from the accelerometer readings:

$$g_{Accel}_{1 \times 3} = accelReadings_{1 \times 3} - linAccelPrior_{1 \times 3}$$

Error Model

The error model is the difference between the gravity estimate from the accelerometer readings and the gravity estimate from the gyroscope readings: $z = g - g_{Accel}$.

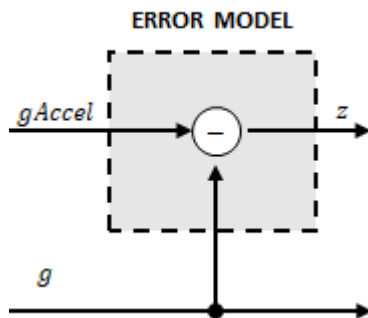

Kalman Equations

The Kalman equations use the gravity estimate derived from the gyroscope readings, g , and the observation of the error process, z , to update the Kalman gain and intermediary covariance matrices. The Kalman gain is applied to the error signal, z , to output an *a posteriori* error estimate, x^+ .

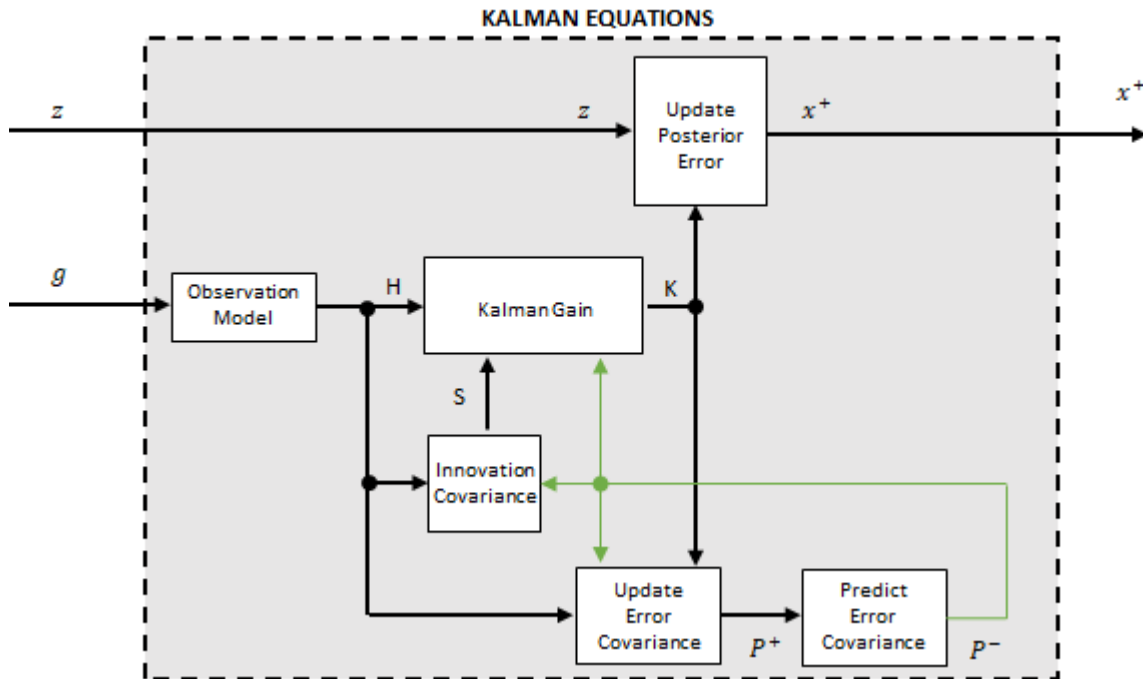

Observation Model

The observation model maps the 1-by-3 observed state, g , into the 3-by-9 true state, H .

The observation model is constructed as:

$$H_{3 \times 9} = \begin{bmatrix} 0 & g_z & -g_y & 0 & -\kappa g_z & \kappa g_y & 1 & 0 & 0 \\ -g_z & 0 & g_x & \kappa g_z & 0 & -\kappa g_x & 0 & 1 & 0 \\ g_y & -g_x & 0 & -\kappa g_y & \kappa g_x & 0 & 0 & 0 & 1 \end{bmatrix}$$

where g_x , g_y , and g_z are the x -, y -, and z -elements of the gravity vector estimated from the orientation, respectively. κ is a constant determined by the SampleRate and DecimationFactor properties: $\kappa = \text{DecimationFactor}/\text{SampleRate}$.

See sections 7.3 and 7.4 of [1] for a derivation of the observation model.

Innovation Covariance

The innovation covariance is a 3-by-3 matrix used to track the variability in the measurements. The innovation covariance matrix is calculated as:

$$S_{3 \times 3} = R_{3 \times 3} + (H_{3 \times 9})(P_{9 \times 9}^-)(H_{3 \times 9})^T$$

where

- H is the observation model matrix
- P^- is the predicted (*a priori*) estimate of the covariance of the observation model calculated in the previous iteration

- R is the covariance of the observation model noise, calculated as:

$$R_{3 \times 3} = (\lambda + \xi + \kappa(\beta + \eta)) \begin{bmatrix} 1 & 0 & 0 \\ 0 & 1 & 0 \\ 0 & 0 & 1 \end{bmatrix}.$$

The following properties define the observation model noise variance:

- κ -- (DecimationFactor/SampleRate)²
- β -- GyroscopeDriftNoise
- η -- GyroscopeNoise
- λ -- AccelerometerNoise
- ξ -- LinearAccelerationNoise

Update Error Estimate Covariance

The error estimate covariance is a 9-by-9 matrix used to track the variability in the state.

The error estimate covariance matrix is updated as:

$$P_{9 \times 9}^+ = P_{9 \times 9}^- - (K_{9 \times 3})(H_{3 \times 9})(P_{9 \times 9}^-)$$

where K is the Kalman gain, H is the measurement matrix, and P^- is the error estimate covariance calculated during the previous iteration.

Predict Error Estimate Covariance

The error estimate covariance is a 9-by-9 matrix used to track the variability in the state. The *a priori* error estimate covariance, P^- , is set to the process noise covariance, Q , determined during the previous iteration. Q is calculated as a function of the *a posteriori* error estimate covariance, P^+ . When calculating Q , the cross-correlation terms are assumed to be negligible compared to the autocorrelation terms, and are set to zero:

$Q =$

$$\begin{bmatrix}
 P^+(1) + \kappa^2 P^+(31) + \beta + \eta & 0 & 0 & -\kappa(P^+(31) + \beta) & 0 \\
 0 & P^+(11) + \kappa^2 P^+(41) + \beta + \eta & 0 & 0 & -\kappa(P^+(41) + \beta) \\
 0 & 0 & P^+(21) + \kappa^2 P^+(51) + \beta + \eta & 0 & 0 \\
 -\kappa(P^+(31) + \beta) & 0 & 0 & P^+(31) + \beta & 0 \\
 0 & -\kappa(P^+(41) + \beta) & 0 & 0 & P^+(41) + \beta \\
 0 & 0 & -\kappa(P^+(51) + \beta) & 0 & 0 \\
 0 & 0 & 0 & 0 & 0 \\
 0 & 0 & 0 & 0 & 0 \\
 0 & 0 & 0 & 0 & 0
 \end{bmatrix}$$

where

- P^+ -- is the updated (*a posteriori*) error estimate covariance
- κ -- DecimationFactor/SampleRate
- β -- GyroscopeDriftNoise
- η -- GyroscopeNoise
- ν -- LinearAcclerationDecayFactor
- ξ -- LinearAccelerationNoise

See section 10.1 of [1] for a derivation of the terms of the process error matrix.

Kalman Gain

The Kalman gain matrix is a 9-by-3 matrix used to weight the innovation. In this algorithm, the innovation is interpreted as the error process, z .

The Kalman gain matrix is constructed as:

$$K_{9 \times 3} = (P_{9 \times 9}^-)(H_{3 \times 9})^T((S_{3 \times 3})^T)^{-1}$$

where

- P^- -- predicted error covariance
- H -- observation model
- S -- innovation covariance

Update a Posteriori Error

The *a posteriori* error estimate is determined by combining the Kalman gain matrix with the error in the gravity vector estimations:

$$x_{9 \times 1} = (K_{9 \times 3})(z_{1 \times 3})^T$$

Correct

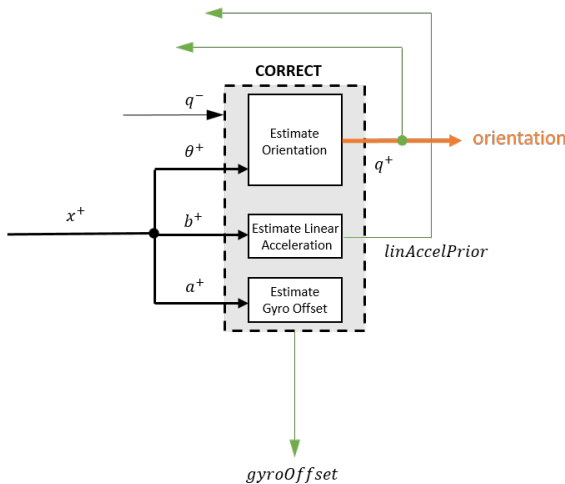

Estimate Orientation

The orientation estimate is updated by multiplying the previous estimation by the error:

$$q^+ = (q^-)(\theta^+)$$

Estimate Linear Acceleration

The linear acceleration estimation is updated by decaying the linear acceleration estimation from the previous iteration and subtracting the error:

$$\text{linAccelPrior} = (\text{linAccelPrior}_{k-1})\nu - b^+$$

where

- ν -- LinearAccelerationDecayFactor

Estimate Gyroscope Offset

The gyroscope offset estimation is updated by subtracting the gyroscope offset error from the gyroscope offset from the previous iteration:

$$\text{gyroOffset} = \text{gyroOffset}_{k-1} - a^+$$

Compute Angular Velocity

To estimate angular velocity, the frame of `gyroReadings` are averaged and the gyroscope offset computed in the previous iteration is subtracted:

$$\text{angularVelocity}_{1 \times 3} = \frac{\sum \text{gyroReadings}_{N \times 3}}{N} - \text{gyroOffset}_{1 \times 3}$$

where N is the decimation factor specified by the `DecimationFactor` property.

The gyroscope offset estimation is initialized to zeros for the first iteration.

References

- [1] Open Source Sensor Fusion. <https://github.com/memsindustrygroup/Open-Source-Sensor-Fusion/tree/master/docs>
- [2] Roetenberg, D., H.J. Luinge, C.T.M. Baten, and P.H. Veltink. "Compensation of Magnetic Disturbances Improves Inertial and Magnetic Sensing of Human Body Segment Orientation." *IEEE Transactions on Neural Systems and Rehabilitation Engineering*. Vol. 13. Issue 3, 2005, pp. 395-405.

Extended Capabilities

C/C++ Code Generation

Generate C and C++ code using MATLAB® Coder™.

Usage notes and limitations:

See "System Objects in MATLAB Code Generation" (MATLAB Coder).

See Also

`ahrsfilter` | `ecompass` | `gpsSensor` | `imuSensor` | `quaternion`

Topics

"Determine Orientation Using Inertial Sensors"

Introduced in R2018b

tune

Tune `imufilter` parameters to reduce estimation error

Syntax

```
tune(filter,sensorData,groundTruth)
tune(___,config)
```

Description

`tune(filter,sensorData,groundTruth)` adjusts the properties of the `imufilter` filter object, `filter`, to reduce the root-mean-squared (RMS) quaternion distance error between the fused sensor data and the ground truth. The function fuses the sensor data to estimate the orientation, which is compared to the orientation in the ground truth. The function uses the property values in the filter as the initial estimate for the optimization algorithm.

`tune(___,config)` specifies the tuning configuration based on a `tunerconfig` object, `config`.

Examples

Tune `imufilter` to Optimize Orientation Estimate

Load recorded sensor data and ground truth data.

```
ld = load('imufilterTuneData.mat');
qTrue = ld.groundTruth.Orientation; % true orientation
```

Create an `imufilter` object and fuse the filter with the sensor data.

```
fuse = imufilter;
qEstUntuned = fuse(ld.sensorData.Accelerometer, ...
    ld.sensorData.Gyroscope);
```

Create a `tunerconfig` object and tune the `imufilter` to improve the orientation estimate.

```
cfg = tunerconfig('imufilter');
tune(fuse, ld.sensorData, ld.groundTruth, cfg);
```

Iteration	Parameter	Metric
1	AccelerometerNoise	0.1149
1	GyroscopeNoise	0.1146
1	GyroscopeDriftNoise	0.1146
1	LinearAccelerationNoise	0.1122
1	LinearAccelerationDecayFactor	0.1103
2	AccelerometerNoise	0.1102
2	GyroscopeNoise	0.1098
2	GyroscopeDriftNoise	0.1098
2	LinearAccelerationNoise	0.1070
2	LinearAccelerationDecayFactor	0.1053
3	AccelerometerNoise	0.1053

3	GyroscopeNoise	0.1048
3	GyroscopeDriftNoise	0.1048
3	LinearAccelerationNoise	0.1016
3	LinearAccelerationDecayFactor	0.1002
4	AccelerometerNoise	0.1001
4	GyroscopeNoise	0.0996
4	GyroscopeDriftNoise	0.0996
4	LinearAccelerationNoise	0.0962
4	LinearAccelerationDecayFactor	0.0950
5	AccelerometerNoise	0.0950
5	GyroscopeNoise	0.0943
5	GyroscopeDriftNoise	0.0943
5	LinearAccelerationNoise	0.0910
5	LinearAccelerationDecayFactor	0.0901
6	AccelerometerNoise	0.0900
6	GyroscopeNoise	0.0893
6	GyroscopeDriftNoise	0.0893
6	LinearAccelerationNoise	0.0862
6	LinearAccelerationDecayFactor	0.0855
7	AccelerometerNoise	0.0855
7	GyroscopeNoise	0.0848
7	GyroscopeDriftNoise	0.0848
7	LinearAccelerationNoise	0.0822
7	LinearAccelerationDecayFactor	0.0818
8	AccelerometerNoise	0.0817
8	GyroscopeNoise	0.0811
8	GyroscopeDriftNoise	0.0811
8	LinearAccelerationNoise	0.0791
8	LinearAccelerationDecayFactor	0.0789
9	AccelerometerNoise	0.0788
9	GyroscopeNoise	0.0782
9	GyroscopeDriftNoise	0.0782
9	LinearAccelerationNoise	0.0769
9	LinearAccelerationDecayFactor	0.0768
10	AccelerometerNoise	0.0768
10	GyroscopeNoise	0.0762
10	GyroscopeDriftNoise	0.0762
10	LinearAccelerationNoise	0.0754
10	LinearAccelerationDecayFactor	0.0753
11	AccelerometerNoise	0.0753
11	GyroscopeNoise	0.0747
11	GyroscopeDriftNoise	0.0747
11	LinearAccelerationNoise	0.0741
11	LinearAccelerationDecayFactor	0.0740
12	AccelerometerNoise	0.0740
12	GyroscopeNoise	0.0734
12	GyroscopeDriftNoise	0.0734
12	LinearAccelerationNoise	0.0728
12	LinearAccelerationDecayFactor	0.0728
13	AccelerometerNoise	0.0728
13	GyroscopeNoise	0.0721
13	GyroscopeDriftNoise	0.0721
13	LinearAccelerationNoise	0.0715
13	LinearAccelerationDecayFactor	0.0715
14	AccelerometerNoise	0.0715
14	GyroscopeNoise	0.0706
14	GyroscopeDriftNoise	0.0706
14	LinearAccelerationNoise	0.0700

14	LinearAccelerationDecayFactor	0.0700
15	AccelerometerNoise	0.0700
15	GyroscopeNoise	0.0690
15	GyroscopeDriftNoise	0.0690
15	LinearAccelerationNoise	0.0684
15	LinearAccelerationDecayFactor	0.0684
16	AccelerometerNoise	0.0684
16	GyroscopeNoise	0.0672
16	GyroscopeDriftNoise	0.0672
16	LinearAccelerationNoise	0.0668
16	LinearAccelerationDecayFactor	0.0667
17	AccelerometerNoise	0.0667
17	GyroscopeNoise	0.0655
17	GyroscopeDriftNoise	0.0655
17	LinearAccelerationNoise	0.0654
17	LinearAccelerationDecayFactor	0.0654
18	AccelerometerNoise	0.0654
18	GyroscopeNoise	0.0641
18	GyroscopeDriftNoise	0.0641
18	LinearAccelerationNoise	0.0640
18	LinearAccelerationDecayFactor	0.0639
19	AccelerometerNoise	0.0639
19	GyroscopeNoise	0.0627
19	GyroscopeDriftNoise	0.0627
19	LinearAccelerationNoise	0.0627
19	LinearAccelerationDecayFactor	0.0624
20	AccelerometerNoise	0.0624
20	GyroscopeNoise	0.0614
20	GyroscopeDriftNoise	0.0614
20	LinearAccelerationNoise	0.0613
20	LinearAccelerationDecayFactor	0.0613

Fuse the sensor data again using the tuned filter.

```
qEstTuned = fuse(ld.sensorData.Accelerometer, ...
    ld.sensorData.Gyroscope);
```

Compare the tuned and untuned filter RMS error performances.

```
dUntuned = rad2deg(dist(qEstUntuned, qTrue));
dTuned = rad2deg(dist(qEstTuned, qTrue));
rmsUntuned = sqrt(mean(dUntuned.^2))
```

```
rmsUntuned = 6.5864
```

```
rmsTuned = sqrt(mean(dTuned.^2))
```

```
rmsTuned = 3.5098
```

Visualize the results.

```
N = numel(dUntuned);
t = (0:N-1)./ fuse.SampleRate;
plot(t, dUntuned, 'r', t, dTuned, 'b');
legend('Untuned', 'Tuned');
title('imufilter - Tuned vs Untuned Error')
xlabel('Time (s)');
ylabel('Orientation Error (degrees)');
```

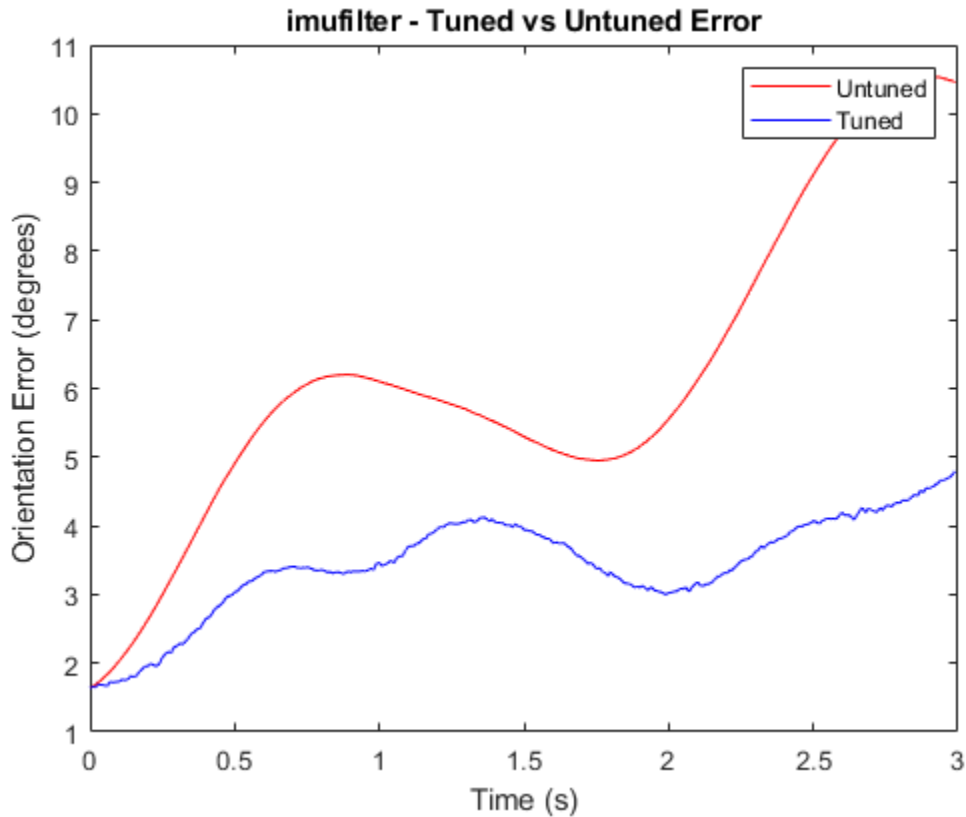
Input Arguments

filter — Filter object

`imufilter` object

Filter object, specified as an `imufilter` object.

sensorData — Sensor data

table

Sensor data, specified as a table. In each row, the sensor data is specified as:

- Accelerometer — Accelerometer data, specified as a 1-by-3 vector of scalars in m^2/s .
- Gyroscope — Gyroscope data, specified as a 1-by-3 vector of scalars in rad/s .

If you set the `Cost` property of the tuner configuration input, `config`, to `Custom`, then you can use other data types for the `sensorData` input based on your choice.

groundTruth — Ground truth data

timetable

Ground truth data, specified as a table. The table has only one column of `Orientation` data. In each row, the orientation is specified as a quaternion object or a 3-by-3 rotation matrix.

The function processes each row of the `sensorData` and `groundTruth` tables sequentially to calculate the state estimate and RMS error from the ground truth. Each row of the `sensorData` and the `groundTruth` tables must correspond to each other.

If you set the `Cost` property of the tuner configuration input, `config`, to `Custom`, then you can use other data types for the `groundTruth` input based on your choice.

config – Tuner configuration

`tunerconfig` object

Tuner configuration, specified as a `tunerconfig` object.

References

- [1] Abbeel, P., Coates, A., Montemerlo, M., Ng, A.Y. and Thrun, S. Discriminative Training of Kalman Filters. In *Robotics: Science and systems*, Vol. 2, pp. 1, 2005.

See Also

Introduced in R2020b

fusionRadarSensor

Generate detections and tracks reports

Description

The `fusionRadarSensor` System object™ generates detection or track reports of targets. You can specify the detection mode of the sensor as monostatic, bistatic, or electronic support measures (ESM) through the `DetectionMode` property. You can use `fusionRadarSensor` to simulate clustered or unclustered detections with added random noise, and also generate false alarm detections. You can fuse the generated detections with other sensor data and track objects using a multi-object tracker, such as `trackerGNN`. You can also output tracks directly from the `fusionRadarSensor` object. To configure whether targets are output as clustered detections, unclustered detections, or tracks, use the `TargetReportFormat` property. You can add `fusionRadarSensor` to a `Platform` and then use the radar in a `trackingScenario`.

Using a single-exponential model, the radar computes range and elevation biases caused by propagation through the troposphere. A range bias means that measured ranges are greater than the line-of-sight range to the target. Elevation bias means that the measured elevations are above their true elevations. Biases are larger when the line-of-sight path between the radar and target passes through lower altitudes because the atmosphere is thicker at these altitudes. See “References” on page 3-118 for more details.

To generate radar detection and track reports:

- 1 Create the `fusionRadarSensor` object and set its properties.
- 2 Call the object with arguments, as if it were a function.

To learn more about how System objects work, see [What Are System Objects?](#).

Creation

Syntax

```
rdr = fusionRadarSensor
rdr = fusionRadarSensor(id)
rdr = fusionRadarSensor( ___, scanConfig)
rdr = fusionRadarSensor( ___, Name, Value)
```

Description

`rdr = fusionRadarSensor` creates a monostatic radar sensor that reports clustered detections and uses default property values.

`rdr = fusionRadarSensor(id)` sets the `SensorIndex` property to the specified `id`.

`rdr = fusionRadarSensor(___, scanConfig)` is a convenience syntax that creates a monostatic radar sensor and sets its scanning configuration to a predefined `scanConfig`. You can

specify `scanConfig` as 'No_scanning', 'Raster', 'Rotator', or 'Sector'. See “Convenience Syntaxes” on page 3-114 for more details on these configurations.

`rdr = fusionRadarSensor(___, Name, Value)` creates a radar sensor and sets “Properties” on page 3-90 using one or more name-value pairs. Enclose each property name in quotes. For example, `radarDataGenerator('TargetReportFormat','Tracks','FilterInitializationFcn',@initcvkf)` creates a radar sensor that generates track reports using a tracker initialized by a constant-velocity linear Kalman filter.

Properties

Unless otherwise indicated, properties are *nontunable*, which means you cannot change their values after calling the object. Objects lock when you call them, and the `release` function unlocks them.

If a property is *tunable*, you can change its value at any time.

For more information on changing property values, see System Design in MATLAB Using System Objects.

Sensor Identification

SensorIndex — Unique sensor identifier

0 (default) | positive integer

Unique sensor identifier, specified as a positive integer. Use this property to distinguish between detections or tracks that come from different sensors in a multisensor system. Specify a unique value for each sensor. If you do not update `SensorIndex` from the default value of 0, then the radar returns an error at the start of simulation.

Data Types: `double`

UpdateRate — Sensor update rate (Hz)

1 (default) | positive real scalar

Sensor update rate, in hertz, specified as a positive real scalar. The reciprocal of the update rate must be an integer multiple of the simulation time interval. The radar generates new reports at intervals defined by this reciprocal value. Any sensor update requested between update intervals contains no detections or tracks.

Data Types: `double`

Sensor Mounting

MountingLocation — Mounting location of radar on platform (m)

[0 0 0] (default) | 1-by-3 real-valued vector

Mounting location of the radar on the platform, in meters, specified as a 1-by-3 real-valued vector of the form $[x\ y\ z]$. This property defines the coordinates of the sensor along the x-axis, y-axis, and z-axis relative to the platform body frame.

Data Types: `double`

MountingAngles — Mounting rotation angles of radar (deg)

[0 0 0] (default) | 1-by-3 real-valued vector of form $[z_{yaw}\ y_{pitch}\ x_{roll}]$

Mounting rotation angles of the radar, in degrees, specified as a 1-by-3 real-valued vector of form $[z_{yaw} \ y_{pitch} \ x_{roll}]$. This property defines the intrinsic Euler angle rotation of the sensor around the z-axis, y-axis, and x-axis with respect to the platform body frame, where:

- z_{yaw} , or yaw angle, rotates the sensor around the z-axis of the platform body frame.
- y_{pitch} , or pitch angle, rotates the sensor around the y-axis of the platform body frame. This rotation is relative to the sensor position that results from the z_{yaw} rotation.
- x_{roll} , or roll angle, rotates the sensor about the x-axis of the platform body frame. This rotation is relative to the sensor position that results from the z_{yaw} and y_{pitch} rotations.

These angles are clockwise-positive when looking in the forward direction of the z-axis, y-axis, and x-axis, respectively.

Data Types: double

Scanning Settings

ScanMode — Scanning mode of radar

'Mechanical' (default) | 'Electronic' | 'Mechanical and electronic' | 'No scanning'

Scanning mode of the radar, specified as 'Mechanical', 'Electronic', 'Mechanical and electronic', or 'No scanning'.

ScanMode	Purpose
'Mechanical'	The sensor scans mechanically across the azimuth and elevation limits specified by the <code>MechanicalAzimuthLimits</code> and <code>MechanicalElevationLimits</code> properties. The scan direction increments by the radar field of view angle between dwells.
'Electronic'	The sensor scans electronically across the azimuth and elevation limits specified by the <code>ElectronicAzimuthLimits</code> and <code>ElectronicElevationLimits</code> properties. The scan direction increments by the radar field of view angle between dwells.
'Mechanical and electronic'	The sensor mechanically scans the antenna boresight across the mechanical scan limits and electronically scans beams relative to the mechanical angles across the electronic scan limits. The total field of regard scanned in this mode is the combination of the mechanical and electronic scan limits. The scan direction increments by the field of view angle between dwells.
'No scanning'	The sensor beam points along the antenna boresight defined by the <code>MountingAngles</code> property.

Example: 'No scanning'

MaxAzimuthScanRate — Maximum mechanical azimuth scan rate (deg/s)

75 (default) | nonnegative scalar

Maximum mechanical azimuth scan rate, specified as a nonnegative scalar in degrees per second. This property sets the maximum scan rate at which the sensor can mechanically scan in azimuth. The sensor sets its scan rate to step the radar mechanical angle by the field of view. If the required scan rate exceeds the maximum scan rate, the maximum scan rate is used.

Dependencies

To enable this property, set the ScanMode property to 'Mechanical' or 'Mechanical and electronic'.

Data Types: double

MaxElevationScanRate — Maximum mechanical elevation scan rate (deg/s)

75 (default) | nonnegative scalar

Maximum mechanical elevation scan rate, specified as a nonnegative scalar in degrees per second. The property sets the maximum scan rate at which the sensor can mechanically scan in elevation. The sensor sets its scan rate to step the radar mechanical angle by the field of view. If the required scan rate exceeds the maximum scan rate, the maximum scan rate is used.

Dependencies

To enable this property, set the ScanMode property to 'Mechanical' or 'Mechanical and electronic'. Also, set the HasElevation property to true.

Data Types: double

MechanicalAzimuthLimits — Mechanical azimuth scan limits (deg)

[0 360] (default) | two-element real-valued vector

Mechanical azimuth scan limits, specified as a two-element real-valued vector of the form [*azMin* *azMax*], where $azMin \leq azMax$ and $azMax - azMin \leq 360$. The limits define the minimum and maximum mechanical azimuth angles, in degrees, the sensor can scan from its mounted orientation.

Example: [-10 20]

Dependencies

To enable this property, set the ScanMode property to 'Mechanical' or 'Mechanical and electronic'.

Data Types: double

MechanicalElevationLimits — Mechanical elevation scan limits (deg)

[-10 0] (default) | two-element real-valued vector

Mechanical elevation scan limits, specified as a two-element real-valued vector of the form [*elMin* *elMax*], where $-90 \leq elMin \leq elMax \leq 90$. The limits define the minimum and maximum mechanical elevation angles, in degrees, the sensor can scan from its mounted orientation.

Example: [-50 20]

Dependencies

To enable this property, set the ScanMode property to 'Mechanical' or 'Mechanical and electronic'. Also, set the HasElevation property to true.

Data Types: double

ElectronicAzimuthLimits — Electronic azimuth scan limits (deg)

[-45 45] (default) | two-element real-valued vector

Electronic azimuth scan limits, specified as a two-element real-valued vector of the form [*azMin azMax*], where $-90 \leq azMin \leq azMax \leq 90$. The limits define the minimum and maximum electronic azimuth angles, in degrees, the sensor can scan from its mounted orientation.

Example: [-50 20]

Dependencies

To enable this property, set the ScanMode property to 'Electronic' or 'Mechanical and electronic'.

Data Types: double

ElectronicElevationLimits — Electronic elevation scan limits (deg)

[-45 45] (default) | two-element real-valued vector

Electronic elevation scan limits, specified as a two-element real-valued vector of the form [*elMin elMax*], where $-90 \leq elMin \leq elMax \leq 90$. The limits define the minimum and maximum electronic elevation angles, in degrees, the sensor can scan from its mounted orientation.

Example: [-50 20]

Dependencies

To enable this property, set the ScanMode property to 'Electronic' or 'Mechanical and electronic'. Also, set the HasElevation property to true.

Data Types: double

MechanicalAngle — Current mechanical scan angle

two-element real-valued vector

This property is read-only.

Current mechanical scan angle of radar, specified as a two-element real-valued vector of the form [*az el*]. *az* and *el* represent the mechanical azimuth and elevation scan angles, respectively, relative to the mounted angle of the radar on the platform.

Data Types: double

ElectronicAngle — Current electronic scan angle

two-element real-valued vector

This property is read-only.

Current electronic scan angle of radar, specified as a two-element real-valued vector of the form [*az el*]. *az* and *el* represent the electronic azimuth and elevation scan angles, respectively, relative to the current mechanical angle.

Data Types: double

LookAngle — Current look angle of sensor

two-element real-valued vector

This property is read-only.

Current look angle of the sensor, specified as a two-element real-valued vector of the form $[az\ el]$. az and el represent the azimuth and elevation look angles, respectively. Look angle is a combination of the mechanical angle and electronic angle, depending on the `ScanMode` property.

ScanMode	LookAngle
'Mechanical'	MechanicalAngle
'Electronic'	ElectronicAngle
'Mechanical and electronic'	MechanicalAngle + ElectronicAngle
'No scanning'	0

Detection Reporting Specifications

DetectionMode — Detection mode

'Monostatic' (default) | 'ESM' | 'Bistatic'

Detection mode, specified as 'Monostatic', 'ESM', or 'Bistatic'. When set to 'Monostatic', the sensor generates detections from reflected signals originating from a collocated radar emitter. When set to 'ESM', the sensor operates passively and can model ESM and (radar warning receiver) RWR systems. When set to 'Bistatic', the sensor generates detections from reflected signals originating from a separate radar emitter. For more details on detection mode, see “Radar Sensor Detection Modes” on page 3-115.

Example: 'Monostatic'

HasElevation — Enable radar to scan in elevation and measure target elevation angles

false or 0 (default) | true or 1

Enable the radar to scan in elevation and measure target elevation angles, specified as a logical 0 (false) or 1 (true). Set this property to true to model a radar sensor that can estimate target elevation.

Data Types: logical

HasRangeRate — Enable radar to measure target range rates

false or 0 (default) | true or 1

Enable the radar to measure target range rates, specified as a logical 0 (false) or 1 (true). Set this property to true to model a radar sensor that can measure range rates from target detections.

Data Types: logical

HasNoise — Enable addition of noise to radar sensor measurements

true or 1 (default) | false or 0

Enable the addition of noise to radar sensor measurements, specified as a logical 1 (true) or 0 (false). Set this property to true to add noise to the radar measurements. Otherwise, the measurements have no noise. Even if you set `HasNoise` to false, the sensor reports the measurement noise covariance matrix specified in the `MeasurementNoise` property of its object detection outputs.

When the sensor reports tracks, the sensor uses the measurement covariance matrix to estimate the track state and state covariance matrix.

Data Types: `logical`

HasFalseAlarms — Enable creating false alarm radar detections

`true` or `1` (default) | `false` or `0`

Enable creating false alarm radar measurements, specified as a logical `1` (`true`) or `0` (`false`). Set this property to `true` to report false alarms. Otherwise, the radar reports only actual detections.

Data Types: `logical`

HasOcclusion — Enable occlusion from extended objects

`true` or `1` (default) | `false` or `0`

Enable occlusion from extended objects, specified as a logical `1` (`true`) or `0` (`false`). Set this property to `true` to model occlusion from extended objects. The sensor models two types of occlusion, self occlusion and inter-object occlusion. Self occlusion occurs when one side of an extended object occludes another side. Inter-object occlusion occurs when one extended object stands in the line of sight of another extended object or a point target. Note that both extended objects and point targets can be occluded by extended objects, but a point target cannot occlude another point target or an extended object.

Data Types: `logical`

HasRangeAmbiguities — Enable range ambiguities

`false` or `0` (default) | `true` or `1`

Enable range ambiguities, specified as a logical `0` (`false`) or `1` (`true`). Set this property to `true` to enable sensor range ambiguities. In this case, the sensor does not resolve range ambiguities, and target ranges beyond the `MaxUnambiguousRange` are wrapped into the interval `[0, MaxUnambiguousRange]`. When `false`, the sensor reports targets at their unambiguous range.

Data Types: `logical`

HasRangeRateAmbiguities — Enable range-rate ambiguities

`false` or `0` (default) | `true` or `1`

Enable range-rate ambiguities, specified as a logical `0` (`false`) or `1` (`true`). Set this property to `true` to enable sensor range-rate ambiguities. When `true`, the sensor does not resolve range rate ambiguities. Target range rates beyond the `MaxUnambiguousRadialSpeed` are wrapped into the interval `[0, MaxUnambiguousRadialSpeed]`. When `false`, the sensor reports targets at their unambiguous range rates.

Dependencies

To enable this property, set the `HasRangeRate` property to `true`.

Data Types: `logical`

HasINS — Enable inertial navigation system (INS) input

`false` or `0` (default) | `true` or `1`

Enable the INS input argument, which passes the current estimate of the sensor platform pose to the sensor, specified as a logical `0` (`false`) or `1` (`true`). When `true`, pose information is added to the `MeasurementParameters` structure of the reported detections or the `StateParameters` structure of the reported tracks, based on the `TargetReportFormat` property. Pose information enables tracking and fusion algorithms to estimate the state of the target in the scenario frame.

Data Types: `logical`

MaxNumReportsSource — Source of maximum for number of detection or track reports

`'Auto'` (default) | `'Property'`

Source of the maximum for the number of detection or track reports, specified as one of these options:

- `'Auto'` — The sensor reports all detections or tracks.
- `'Property'` — The sensor reports the first N valid detections or tracks, where N is equal to the `MaxNumReports` property value.

MaxNumReports — Maximum number of detection or track reports

`100` (default) | positive integer

Maximum number of detection or track reports, specified as a positive integer. The sensor reports detections, in order of increasing distance from the sensor, until reaching this maximum number.

Dependencies

To enable this property, set the `MaxNumReportsSource` property to `'Property'`.

Data Types: `double`

TargetReportFormat — Format of generated target reports

`'Clustered detections'` (default) | `'Tracks'` | `'Detections'`

Format of generated target reports, specified as one of these options:

- `'Clustered detections'` — The sensor generates target reports as clustered detections, where each target is reported as a single detection that is the centroid of the unclustered target detections. The sensor returns clustered detections as a cell array of `objectDetection` objects. To enable this option, set the `DetectionMode` property to `'Monostatic'` and set the `EmissionsInputPort` property to `false`.
- `'Tracks'` — The sensor generates target reports as tracks, which are clustered detections that have been processed by a tracking filter. The sensor returns tracks as an array of `objectTrack` objects. To enable this option, set the `DetectionMode` property to `'Monostatic'` and set the `EmissionsInputPort` property to `false`.
- `'Detections'` — The sensor generates target reports as unclustered detections, where each target can have multiple detections. The sensor returns unclustered detections as a cell array of `objectDetection` objects.

DetectionCoordinates — Coordinate system used to report detections

`'Body'` | `'Scenario'` | `'Sensor rectangular'` | `'Sensor spherical'`

Coordinate system used to report detections, specified as one of these options::

- `'Scenario'` — Detections are reported in the rectangular scenario coordinate frame. The scenario coordinate system is defined as the local navigation frame at simulation start time. To enable this value, set the `HasINS` property to `true`.
- `'Body'` — Detections are reported in the rectangular body system of the sensor platform.
- `'Sensor rectangular'` — Detections are reported in the sensor rectangular body coordinate system.

- `'Sensor spherical'` — Detections are reported in a spherical coordinate system derived from the sensor rectangular body coordinate system. This coordinate system is centered at the sensor and aligned with the orientation of the radar on the platform.

When the `DetectionMode` property is set to `'Monostatic'`, you can specify the `DetectionCoordinates` as `'Body'` (default for `'Monostatic'`), `'Scenario'`, `'Sensor rectangular'`, or `'Sensor spherical'`. When the `DetectionMode` property is set to `'ESM'` or `'Bistatic'`, the default value of the `DetectionCoordinates` property is `'Sensor spherical'`, which cannot be changed.

Example: `'Sensor spherical'`

Measurement Resolution and Bias

AzimuthResolution — Azimuth resolution of radar (deg)

1 (default) | positive real scalar

Azimuth resolution of the radar, in degrees, specified as a positive scalar. The azimuth resolution defines the minimum separation in azimuth angle at which the radar can distinguish between two targets. The azimuth resolution is typically the half-power beamwidth of the azimuth angle beamwidth of the radar.

Data Types: `double`

ElevationResolution — Elevation resolution of radar (deg)

5 (default) | positive real scalar

Elevation resolution of the radar, in degrees, specified as a positive real scalar. The elevation resolution defines the minimum separation in elevation angle at which the radar can distinguish between two targets. The elevation resolution is typically the half-power beamwidth of the elevation angle beamwidth of the radar.

Dependencies

To enable this property, set the `HasElevation` property to `true`.

Data Types: `double`

RangeResolution — Range resolution of radar (m)

100 (default) | positive real scalar

Range resolution of the radar, in meters, specified as a positive real scalar. The range resolution defines the minimum separation in range at which the radar can distinguish between two targets.

Data Types: `double`

RangeRateResolution — Range-rate resolution of radar (m/s)

10 (default) | positive real scalar

Range-rate resolution of the radar, in meters per second, specified as a positive real scalar. The range rate resolution defines the minimum separation in range rate at which the radar can distinguish between two targets.

Dependencies

To enable this property, set the `HasRangeRate` property to `true`.

Data Types: `double`

AzimuthBiasFraction — Azimuth bias fraction of radar

0.1 (default) | nonnegative scalar

Azimuth bias fraction of the radar, specified as a nonnegative scalar. Azimuth bias is expressed as a fraction of the azimuth resolution specified in the `AzimuthResolution` property. This value sets a lower bound on the azimuthal accuracy of the radar and is dimensionless.

Data Types: `double`

ElevationBiasFraction — Elevation bias fraction of radar

0.1 (default) | nonnegative scalar

Elevation bias fraction of the radar, specified as a nonnegative scalar. Elevation bias is expressed as a fraction of the elevation resolution specified by the `ElevationResolution` property. This value sets a lower bound on the elevation accuracy of the radar and is dimensionless.

Dependencies

To enable this property, set the `HasElevation` property to `true`.

Data Types: `double`

RangeBiasFraction — Range bias fraction

0.05 (default) | nonnegative scalar

Range bias fraction of the radar, specified as a nonnegative scalar. Range bias is expressed as a fraction of the range resolution specified by the `RangeResolution` property. This property sets a lower bound on the range accuracy of the radar and is dimensionless.

Data Types: `double`

RangeRateBiasFraction — Range-rate bias fraction

0.05 (default) | nonnegative scalar

Range-rate bias fraction of the radar, specified as a nonnegative scalar. Range-rate bias is expressed as a fraction of the range-rate resolution specified by the `RangeRateResolution` property. This property sets a lower bound on the range rate accuracy of the radar and is dimensionless.

Dependencies

To enable this property, set the `HasRangeRate` property to `true`.

Data Types: `double`

Detection Settings**CenterFrequency — Center frequency of radar band (Hz)**

300e6 (default) | positive real scalar

Center frequency of the radar band, in hertz, specified as a positive real scalar.

Data Types: `double`

Bandwidth — Radar waveform bandwidth

3e6 (default) | positive real scalar

Radar waveform bandwidth, in hertz, specified as a positive real scalar.

Example: `100e3`

Data Types: double

WaveformTypes — Types of detectable waveforms

0 (default) | L -element vector of nonnegative integers

Types of detectable waveforms, specified as an L -element vector of nonnegative integers. Each integer represents a type of waveform detectable by the radar.

Example: [1 4 5]

Data Types: double

ConfusionMatrix — Probability of correct classification of detected waveform

1 (default) | positive scalar | L -element vector of nonnegative real values | L -by- L matrix of nonnegative real values

Probability of correct classification of a detected waveform, specified as a positive scalar, an L -element vector of nonnegative real values, or an L -by- L matrix of nonnegative real values, where L is the number of waveform types detectable by the sensor, as indicated by the value set in the **WaveformTypes** property. Matrix values must be in the range [0, 1].

The (i, j) matrix element represents the probability of classifying the i th waveform as the j th waveform. When you specify this property as a scalar from 0 through 1, the value is expanded along the diagonal of the confusion matrix. When specified as a vector, the vector is aligned as the diagonal of the confusion matrix. When defined as a scalar or a vector, the off-diagonal values are set to $(1 - val)/(L - 1)$, where val is the value of the diagonal element.

Data Types: double

Sensitivity — Minimum operational sensitivity of receiver

-50 (default) | scalar

Minimum operational sensitivity of receiver, specified as a scalar. Sensitivity includes isotropic antenna receiver gain. Units are in dBmi.

Example: -10

Data Types: double

DetectionThreshold — Minimum SNR required to declare detection

5 (default) | scalar

Minimum signal-to-noise ratio (SNR) required to declare a detection, specified as a scalar. Units are in dB.

Example: -1

Data Types: double

DetectionProbability — Probability of detecting target

0.9 (default) | scalar in range (0, 1]

Probability of detecting a target, specified as a scalar in the range (0, 1]. This property defines the probability of detecting a target with a radar cross-section (RCS), **ReferenceRCS**, at the reference detection range, **ReferenceRange**.

Data Types: double

ReferenceRange — Reference range for given probability of detection (m)

100e3 (default) | positive real scalar

Reference range for the given probability of detection and the given reference radar cross-section (RCS), in meters, specified as a positive real scalar. The reference range is the range, at which a target having a radar cross-section specified by the ReferenceRCS property is detected with a probability of detection specified by the DetectionProbability property.

Data Types: double

ReferenceRCS — Reference radar cross-section for given probability of detection (dBsm)

0 (default) | real scalar

Reference radar cross-section (RCS) for a given probability of detection and reference range, in decibel square meters, specified as a real scalar. The reference RCS is the RCS value at which a target is detected with a probability specified by DetectionProbability at the specified ReferenceRange value.

Data Types: double

FalseAlarmRate — False alarm report rate1e-6 (default) | positive real scalar in range $[10^{-7}, 10^{-3}]$

False alarm report rate within each radar resolution cell, specified as a positive real scalar in the range $[10^{-7}, 10^{-3}]$. Units are dimensionless. The object determines resolution cells from the AzimuthResolution and RangeResolution properties and, when enabled, from the ElevationResolution and RangeRateResolution properties.

Data Types: double

FieldOfView — Angular field of view of radar (deg)

[1 5] | 1-by-2 positive real-valued vector

Angular field of view of the radar, in degrees, specified as a 1-by-2 positive real-valued vector of the form $[azfov\ elfov]$. The field of view defines the total angular extent spanned by the sensor. The azimuth field of view, *azfov*, must be in the range (0, 360]. The elevation field of view, *elfov*, must be in the range (0, 180].

Data Types: double

RangeLimits — Minimum and maximum range of radar (m)

[0 100e3] (default) | 1-by-2 nonnegative real-valued vector

Minimum and maximum range of radar, in meters, specified as a 1-by-2 nonnegative real-valued vector of the form $[\min, \max]$. The radar does not detect targets that are outside this range. The maximum range, *max*, must be greater than the minimum range, *min*.

RangeRateLimits — Minimum and maximum range rate of radar (m/s)

[-200 200] (default) | 1-by-2 real-valued vector

Minimum and maximum range rate of radar, in meters per second, specified as a 1-by-2 real-valued vector of the form $[\min, \max]$. The radar does not detect targets that are outside this range rate. The maximum range rate, *max*, must be greater than the minimum range rate, *min*.

Dependencies

To enable this property, set the HasRangeRate property to `true`.

MaxUnambiguousRange — Maximum unambiguous detection range

100e3 (default) | positive scalar

Maximum unambiguous detection range, specified as a positive scalar in meters. Maximum unambiguous range defines the maximum range for which the radar can unambiguously resolve the range of a target. When `HasRangeAmbiguities` is set to `true`, targets detected at ranges beyond the maximum unambiguous range are wrapped into the range interval $[0, \text{MaxUnambiguousRange}]$.

This property also applies to false target detections when you set the `HasFalseAlarms` property to `true`. In this case, the property defines the maximum range at which false alarms can be generated.

Example: `5e3`

Dependencies

To enable this property, set the `HasRangeAmbiguities` property to `true`.

Data Types: `double`

MaxUnambiguousRadialSpeed — Maximum unambiguous radial speed

200 (default) | positive scalar

Maximum unambiguous radial speed, specified as a positive scalar in meters per second. Radial speed is the magnitude of the target range rate. Maximum unambiguous radial speed defines the radial speed for which the radar can unambiguously resolve the range rate of a target. When `HasRangeRateAmbiguities` is set to `true`, targets detected at range rates beyond the maximum unambiguous radial speed are wrapped into the range rate interval $[-\text{MaxUnambiguousRadialSpeed}, \text{MaxUnambiguousRadialSpeed}]$.

This property also applies to false target detections obtained when you set both the `HasRangeRate` and `HasFalseAlarms` properties to `true`. In this case, the property defines the maximum radial speed at which false alarms can be generated.

Dependencies

To enable this property, set `HasRangeRate` and `HasRangeRateAmbiguities` to `true`.

Data Types: `double`

RadarLoopGain — Radar loop gain

real scalar

This property is read-only.

Radar loop gain, specified as a real scalar. `RadarLoopGain` depends on the values of the `DetectionProbability`, `ReferenceRange`, `ReferenceRCS`, and `FalseAlarmRate` properties. Radar loop gain is a function of the reported signal-to-noise ratio of the radar, SNR , the target radar cross-section, RCS , and the target range, R , as described by this equation:

$$SNR = \text{RadarLoopGain} + RCS - 40\log_{10}(R)$$

SNR and RCS are in decibels and decibel square meters, respectively, R is in meters, and `RadarLoopGain` is in decibels.

Data Types: `double`

Interference and Emission Inputs

InterferenceInputPort — Enable interference input

false or 0 (default) | true or 1

Enable interference input, specified as a logical 0 (false) or 1 (true). Set this property to true to enable interference input when running the radar.

Dependencies

To enable this property, set `DetectionMode` to 'Monostatic' and set `EmissionsInputPort` to false.

Data Types: logical

EmissionsInputPort — Enable emissions input

false or 0 (default) | true or 1

Enable emissions input, specified as a logical 0 (false) or 1 (true). Set this property to true to enable emissions input when running the radar.

Dependencies

To enable this property, set `DetectionMode` to 'Monostatic' and set `InterferenceInputPort` to false.

Data Types: logical

EmitterIndex — Unique identifier of monostatic emitter

1 (default) | positive integer

Unique identifier of the monostatic emitter, specified as a positive integer. Use this index to identify the monostatic emitter providing the reference emission for the radar.

Dependencies

To enable this property, set `DetectionMode` to 'Monostatic' and set `EmissionsInputPort` to true.

Data Types: double

Tracking Settings

FilterInitializationFcn — Kalman filter initialization function

@initcvkekf (default) | function handle | character vector | string scalar

Kalman filter initialization function, specified as a function handle or as a character vector or string scalar of the name of a valid Kalman filter initialization function.

The table shows the initialization functions that you can use to specify `FilterInitializationFcn`.

Initialization Function	Function Definition
<code>initcvabf</code>	Initialize constant-velocity alpha-beta filter
<code>initcaabf</code>	Initialize constant-acceleration alpha-beta filter
<code>initcvekf</code>	Initialize constant-velocity extended Kalman filter.
<code>initcackf</code>	Initialize constant-acceleration cubature filter.

Initialization Function	Function Definition
<code>initctckf</code>	Initialize constant-turn-rate cubature filter.
<code>initcvckf</code>	Initialize constant-velocity cubature filter.
<code>initcapf</code>	Initialize constant-acceleration particle filter.
<code>initctpf</code>	Initialize constant-turn-rate particle filter.
<code>initcvpf</code>	Initialize constant-velocity particle filter.
<code>initcvkf</code>	Initialize constant-velocity linear Kalman filter.
<code>initcvukf</code>	Initialize constant-velocity unscented Kalman filter.
<code>initcaekf</code>	Initialize constant-acceleration extended Kalman filter.
<code>initcakf</code>	Initialize constant-acceleration linear Kalman filter.
<code>initcaukf</code>	Initialize constant-acceleration unscented Kalman filter.
<code>initctekf</code>	Initialize constant-turn-rate extended Kalman filter.
<code>initctukf</code>	Initialize constant-turn-rate unscented Kalman filter.
<code>initekfimm</code>	Initialize tracking IMM filter.
<code>initsingerekf</code>	Initialize singer acceleration extended Kalman filter.

You can also write your own initialization function. The function must have the following syntax:

```
filter = filterInitializationFcn(detection)
```

The input to this function is a detection report like those created by an `objectDetection` object. The output of this function must be a tracking filter object, such as `trackingKF`, `trackingEKF`, `trackingUKF`, or `trackingABF`.

To guide you in writing this function, you can examine the details of the supplied functions. For example:

```
type initcvkf
```

Dependencies

To enable this property, set the `TargetReportFormat` property to 'Tracks'.

Data Types: `function_handle` | `char` | `string`

ConfirmationThreshold — Threshold for track confirmation

[2 3] (default) | 1-by-2 vector of positive integers

Threshold for track confirmation, specified as a 1-by-2 vector of positive integers of the form [M N]. A track is confirmed if it receives at least M detections in the last N updates. M must be less than or equal to N.

- When setting *M*, take into account the probability of object detection for the sensors. The probability of detection depends on factors such as occlusion or clutter. You can reduce *M* when tracks fail to be confirmed or increase *M* when too many false detections are assigned to tracks.
- When setting *N*, consider the number of times you want the tracker to update before it makes a confirmation decision. For example, if a tracker updates every 0.05 seconds, and you want to allow 0.5 seconds to make a confirmation decision, set $N = 10$.

Example: [3 5]

Dependencies

To enable this property, set the `TargetReportFormat` property to 'Tracks'.

Data Types: double

DeletionThreshold — Threshold for track deletion

[5 5] (default) | 1-by-2 vector of positive integers

Threshold for track deletion, specified as a 1-by-2 vector of positive integers of the form [P R]. If a confirmed track is not assigned to any detection *P* times in the last *R* tracker updates, then the track is deleted. *P* must be less than or equal to *R*.

- To reduce how long the radar maintains tracks, decrease *R* or increase *P*.
- To maintain tracks for a longer time, increase *R* or decrease *P*.

Example: [3 5]

Dependencies

To enable this property, set the `TargetReportFormat` property to 'Tracks'.

Data Types: double

TrackCoordinates — Coordinate system of reported tracks

'Scenario' | 'Body' | 'Sensor rectangular' | 'Sensor spherical'

Coordinate system used to report tracks, specified as one of these options:

- 'Scenario' — Tracks are reported in the rectangular scenario coordinate frame. The scenario coordinate system is defined as the local navigation frame at simulation start time. To enable this option, set the `HasINS` property to `true`.
- 'Body' — Tracks are reported in the rectangular body system of the sensor platform.
- 'Sensor' — Tracks are reported in the sensor rectangular body coordinate system.

Dependencies

To enable this property, set the `TargetReportFormat` property to 'Tracks'.

Target Profiles

Profiles — Physical characteristics of target platforms

structure | array of structures

Physical characteristics of target platforms, specified as a structure or an array of structures. Each structure must contain the `PlatformID` and `Position` fields. Unspecified fields take default values.

Field	Description	Default Value
PlatformID	Scenario-defined platform identifier, defined as a positive integer.	0
ClassID	User-defined platform classification identifier, defined as a nonnegative integer.	0
Dimensions	Platform dimensions, defined as a structure with these fields: <ul style="list-style-type: none"> • Length • Width • Height • OriginOffset 	0
Signatures	Platform signatures, defined as a cell array containing an <code>rccSignature</code> object, which specifies the RCS signature of the platform.	The default <code>rccSignature</code> object

See `Platform` for more details on these fields.

Data Types: `struct`

Usage

Syntax

```
reports = rdr(targetPoses, simTime)
reports = rdr(targetPoses, interferences, simTime)
reports = rdr(emissions, emitterConfigs, simTime)
```

```
reports = rdr(emissions, simTime)
```

```
[ __ ] = rdr( __, insPose, simTime)
```

```
[reports, numReports, config] = rdr( __ )
```

Description

Monostatic Detection Mode

These syntaxes apply when you set the `DetectionMode` property to `'Monostatic'`.

`reports = rdr(targetPoses, simTime)` returns monostatic target reports from the target poses, `targetPoses`, at the current simulation time, `simTime`. The object can generate reports for multiple targets. To enable this syntax:

- Set the `DetectionMode` property to `'Monostatic'`.
- Set the `InterferenceInputPort` property to `false`.

- Set the `EmissionsInputPort` property to `false`.

`reports = rdr(targetPoses,interferences,simTime)` specifies the interference signals, `interferences`, in the radar signal transmission. To enable this syntax:

- Set the `DetectionMode` property to `'Monostatic'`.
- Set the `InterferenceInputPort` property to `true`.
- Set the `EmissionsInputPort` property to `false`.

`reports = rdr(emissions,emitterConfigs,simTime)` returns monostatic target reports based on the emission signal, `emissions`, and the configurations of the corresponding emitters, `emitterConfigs`, that generate the emissions. To enable this syntax:

- Set the `DetectionMode` property to `'Monostatic'`.
- Set the `InterferenceInputPort` property to `false`.
- Set the `EmissionsInputPort` property to `true`.

Bistatic or ESM Detection Mode

This syntax applies when you set the `DetectionMode` property to `'Bistatic'` or `'ESM'`. In these two modes, the `TargetReportFormat` can only be `'Detections'` and the `DetectionCoordinates` can only be `'Sensor spherical'`.

`reports = rdr(emissions,simTime)` returns Bistatic or ESM reports form radar signal emissions at the simulation time, `simTime`.

Provide INS Input

This syntax applies when you set the `HasINS` property to `true`.

`[___] = rdr(___,insPose,simTime)` specifies the pose information of the radar platform through an INS estimate. Notice that the `insPose` argument is the second to the last argument before the `simTime` argument. This syntax can be used with any of the previous syntaxes. See the `HasINS` property for more details.

Output Additional Information

Use this syntax if you want to output additional information of the reports.

`[reports,numReports,config] = rdr(___)` returns the number of reports, `numReports`, and the configuration of the radar, `config`, at the current simulation time.

Input Arguments

targetPoses — Target poses

structure array

Radar scenario target poses, specified as an array of structures. Each structure corresponds to a target. You can generate the structure using the `targetPoses` object function of a platform. You can also create such a structure manually. This table shows the fields of the structure:

Field	Description
PlatformID	Unique identifier for the platform, specified as a positive integer. This is a required field with no default value.
ClassID	User-defined integer used to classify the type of target, specified as a nonnegative integer. 0 is reserved for unclassified platform types and is the default value.
Position	Position of target in platform coordinates, specified as a real-valued, 1-by-3 vector. This is a required field with no default value. Units are in meters.
Velocity	Velocity of target in platform coordinates, specified as a real-valued, 1-by-3 vector. Units are in meters per second. The default is [0 0 0].
Acceleration	Acceleration of target in platform coordinates, specified as a 1-by-3 row vector. Units are in meters per second-squared. The default is [0 0 0].
Orientation	Orientation of the target with respect to platform coordinates, specified as a scalar quaternion or a 3-by-3 rotation matrix. Orientation defines the frame rotation from the platform coordinate system to the current target body coordinate system. Units are dimensionless. The default is quaternion(1,0,0,0).
AngularVelocity	Angular velocity of the target in platform coordinates, specified as a real-valued, 1-by-3 vector. The magnitude of the vector defines the angular speed. The direction defines the axis of clockwise rotation. Units are in degrees per second. The default is [0 0 0].

The values of the **Position**, **Velocity**, and **Orientation** fields are defined with respect to the platform body frame.

If the dimensions of the target or RCS signature change with respect to time, you can specify these two additional fields in the structure:

Field	Description
Dimensions	Platform dimensions, specified as a structure with these fields: <ul style="list-style-type: none"> • Length • Width • Height • OriginOffset

Field	Description
Signatures	Platform signatures, specified as a cell array containing an <code>rCSSignature</code> object, which specifies the RCS signature of the platform.

If the target’s dimensions and RCS signature remain static with respect to time, you can specify its dimensions and RCS signature using the Profiles property.

interferences – Interference radar emissions

array of `radarEmission` objects | cell array of `radarEmission` objects | array of structures

Interference radar emissions, specified as an array or a cell array of `radarEmission` objects. You can also specify `interferences` as an array of structures with field names corresponding to the property names of the `radarEmission` object.

emissions – Radar emissions

array of `radarEmission` objects | cell array of `radarEmission` objects | array of structures

Radar emissions, specified as an array or cell array of `radarEmission` objects. You can also specify `emissions` as an array of structures with field names corresponding to the property names of the `radarEmission` object.

emitterConfigs – Emitter configurations

array of structures

Emitter configurations, specified as an array of structures. This array must contain the configuration of the radar emitter whose `EmitterIndex` matches the value of the `EmitterIndex` property of the `radarDataGenerator`. Each structure has these fields:

Field	Description
<code>EmitterIndex</code>	Unique emitter index.
<code>IsValidTime</code>	Valid emission time, returned as 0 or 1. The value of <code>IsValidTime</code> is 0 when emitter updates are requested at times that are between update intervals specified by <code>UpdateInterval</code> .
<code>IsScanDone</code>	<code>IsScanDone</code> is true when the emitter has completed a scan.
<code>FieldOfView</code>	Field of view of the emitter.
<code>MeasurementParameters</code>	<code>MeasurementParameters</code> is an array of structures containing the coordinate frame transforms needed to transform positions and velocities in the top-level frame to the current emitter frame.

For more details on `MeasurementParameters`, see “Measurement Parameters” on page 3-116.

Data Types: struct

insPose – Platform pose from INS

structure

Platform pose information from an inertial navigation system (INS), specified as a structure with these fields:

Field	Definition
Position	Position in the scenario frame, specified as a real-valued 1-by-3 vector. Units are in meters.
Velocity	Velocity in the scenario frame, specified as a real-valued 1-by-3 vector. Units are in meters per second.
Orientation	Orientation with respect to the scenario frame, specified as a quaternion or a 3-by-3 real-valued rotation matrix. The rotation is from the navigation frame to the current INS body frame. This is also referred to as a "parent to child" rotation.

simTime — Current simulation time

nonnegative scalar

Current simulation time, specified as a nonnegative scalar. The `trackingScenario` object calls the scan radar sensor at regular time intervals. The sensor only generates reports at simulation times corresponding to integer multiples of the update interval, which is given by the reciprocal of the `UpdateRate` property.

- When called at these intervals, targets are reported in `reports`, the number of reports is returned in `numReports`, and the `IsValidTime` field of the returned `config` structure is returned as `true`.
- When called at all other simulation times, the sensor returns an empty report, `numReports` is returned as `0`, and the `IsValidTime` field of the returned `config` structure is returned as `false`.

Example: `10.5`

Data Types: `double`

Output Arguments

reports — Detection and track reports

cell array of `objectDetection` objects | cell array of `objectTrack` objects

Detection and track reports, returned as:

- A cell array of `objectDetection` objects, when the `TargetReportFormat` property is set to `'Detections'` or `'Clustered detections'`. Additionally, when the `DetectionMode` is set to `'ESM'` or `'Bistatic'`, the sensor can only generate unclustered detections and cannot generate clustered detections.
- A cell array of `objectTrack` objects, when the `TargetReportFormat` property is set to `'Tracks'`. The sensor can only output tracks when the `DetectionMode` is set to `'Monostatic'`. The sensor returns only confirmed tracks, which are tracks that satisfy the confirmation threshold specified in the `ConfirmationThreshold` property. For these tracks, the `IsConfirmed` property of the object is `true`.

In generated code, reports return as equivalent structures with field names corresponding to the property names of the `objectDetection` object or the property names of the `objectTrack` objects, based on the `TargetReportFormat` property.

The format and coordinates of the measurement states or track states is determined by the specifications of the `HasRangeRate`, `HasElevation`, `HasINS`, `TaregetReportFormat`, and `DetectionCoordinates` properties. For more details, see “Detection and Track State Coordinates” on page 3-116.

numReports – Number of reported detections or tracks

nonnegative integer

Number of reported detections or tracks, returned as a nonnegative integer. `numReports` is equal to the length of the `reports` argument.

Data Types: `double`

config – Current sensor configuration

structure

Current sensor configuration, specified as a structure. This output can be used to determine which objects fall within the radar beam during object execution.

Field	Description
<code>SensorIndex</code>	Unique sensor index, returned as a positive integer.
<code>IsValidTime</code>	Valid detection time, returned as <code>true</code> or <code>false</code> . <code>IsValidTime</code> is <code>false</code> when detection updates are requested between update intervals specified by the update rate.
<code>IsScanDone</code>	<code>IsScanDone</code> is <code>true</code> when the sensor has completed a scan.
<code>FieldOfView</code>	Field of view of the sensor, returned as a 2-by-1 vector of positive real values, <code>[azfov;elfov]</code> . <code>azfov</code> and <code>elfov</code> represent the field of view in azimuth and elevation, respectively.
<code>MeasurementParameters</code>	Sensor measurement parameters, returned as an array of structures containing the coordinate frame transforms needed to transform positions and velocities in the top-level frame to the current sensor frame.

Data Types: `struct`

Object Functions

To use an object function, specify the System object as the first input argument. For example, to release system resources of a System object named `obj`, use this syntax:

```
release(obj)
```

Specific to fusionRadarSensor

coverageConfig Sensor and emitter coverage configuration
 perturb Apply perturbations to object
 perturbations Perturbation defined on object

Common to All System Objects

step Run System object algorithm
 release Release resources and allow changes to System object property values and input characteristics
 reset Reset internal states of System object

Examples

Model Air Traffic Control Tower Scanning

Create three targets by specifying their platform ID, position, and velocity.

```
tgt1 = struct('PlatformID',1, ...
    'Position',[0 -50e3 -1e3], ...
    'Velocity',[0 900*1e3/3600 0]);

tgt2 = struct('PlatformID',2, ...
    'Position',[20e3 0 -500], ...
    'Velocity',[700*1e3/3600 0 0]);

tgt3 = struct('PlatformID',3, ...
    'Position',[-20e3 0 -500], ...
    'Velocity',[300*1e3/3600 0 0]);
```

Create an airport surveillance radar that is 15 meters above the ground.

```
rpm = 12.5;
fov = [1.4; 5]; % [azimuth; elevation]
scanrate = rpm*360/60; % deg/s
updaterate = scanrate/fov(1); % Hz

sensor = fusionRadarSensor(1,'Rotator', ...
    'UpdateRate',updaterate, ...
    'MountingLocation',[0 0 -15], ...
    'MaxAzimuthScanRate',scanrate, ...
    'FieldOfView',fov, ...
    'AzimuthResolution',fov(1));
```

Generate detections from a full scan of the radar.

```
simTime = 0;
detBuffer = {};
while true
    [dets,numDets,config] = sensor([tgt1 tgt2 tgt3],simTime);
    detBuffer = [detBuffer; dets]; %#ok<AGROW>

    % Is full scan complete?
    if config.IsScanDone
        break % yes
```

```
    end
    simTime = simTime + 1/sensor.UpdateRate;
end

radarPosition = [0 0 0];
tgtPositions = [tgt1.Position; tgt2.Position; tgt3.Position];

Visualize the results.

clrs = lines(3);

figure
hold on

% Plot radar position
plot3(radarPosition(1),radarPosition(2),radarPosition(3),'Marker','s', ...
      'DisplayName','Radar','MarkerFaceColor',clrs(1,:),'LineStyle','none')

% Plot truth
plot3(tgtPositions(:,1),tgtPositions(:,2),tgtPositions(:,3),'Marker','^', ...
      'DisplayName','Truth','MarkerFaceColor',clrs(2,:),'LineStyle','none')

% Plot detections
if ~isempty(detBuffer)
    detPos = cellfun(@(d)d.Measurement(1:3),detBuffer, ...
                    'UniformOutput',false);
    detPos = cell2mat(detPos)';
    plot3(detPos(:,1),detPos(:,2),detPos(:,3),'Marker','o', ...
          'DisplayName','Detections','MarkerFaceColor',clrs(3,:),'LineStyle','none')
end

xlabel('X(m)')
ylabel('Y(m)')
axis('equal')
legend
```

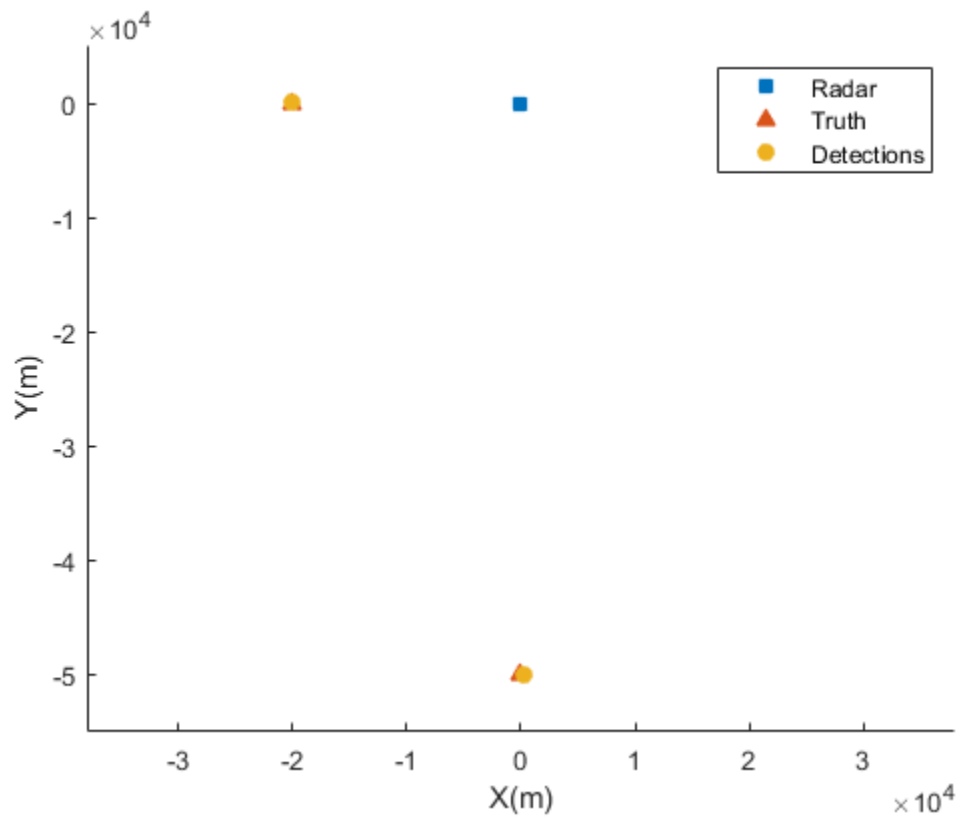

Detect Radar Emission with fusionRadarSensor

Create an radar emission and then detect the emission using a fusionRadarSensor object.

First, create an radar emission.

```
orient = quaternion([180 0 0], 'eulerd', 'zyx', 'frame');
rfSig = radarEmission('PlatformID',1,'EmitterIndex',1,'EIRP',100, ...
    'OriginPosition',[30 0 0],'Orientation',orient);
```

Then, create an ESM sensor using fusionRadarSensor.

```
sensor = fusionRadarSensor(1,'DetectionMode','ESM');
```

Detect the RF emission.

```
time = 0;
[dets,numDets,config] = sensor(rfSig,time)
```

```
dets = 1x1 cell array
    {1x1 objectDetection}
```

```
numDets = 1
```

```
config = struct with fields:
    SensorIndex: 1
    IsValidTime: 1
    IsScanDone: 0
    FieldOfView: [1 5]
    MeasurementParameters: [1x1 struct]
```

Algorithms

Convenience Syntaxes

The convenience syntaxes set several properties together to model a specific type of radar.

No Scanning

Sets ScanMode to 'No scanning'.

Raster Scanning

This syntax sets these properties:

Property	Value
ScanMode	'Mechanical'
HasElevation	true
MaxMechanicalScanRate	[75; 75]
MechanicalScanLimits	[-45 45; -10 0]
ElectronicScanLimits	[-45 45; -10 0]

You can change the ScanMode property to 'Electronic' to perform an electronic raster scan over the same volume as a mechanical scan.

Rotator Scanning

This syntax sets these properties:

Property	Value
ScanMode	'Mechanical'
FieldOfView	[1;10]
HasElevation	false or true
MechanicalScanLimits	[0 360; -10 0]
ElevationResolution	10/sqrt(12)

Sector Scanning

This syntax sets these properties:

Property	Value
ScanMode	'Mechanical'

FieldOfView	[1; 10]
HasElevation	false
MechanicalScanLimits	[-45 45; -10 0]
ElectronicScanLimits	[-45 45; -10 0]
ElevationResolution	10/sqrt(12)

Changing the ScanMode property to 'Electronic' lets you perform an electronic raster scan over the same volume as a mechanical scan.

Radar Sensor Detection Modes

The fusionRadarSensor System object can model three detection modes: monostatic, bistatic, and electronic support measures (ESM) as shown in the following figures.

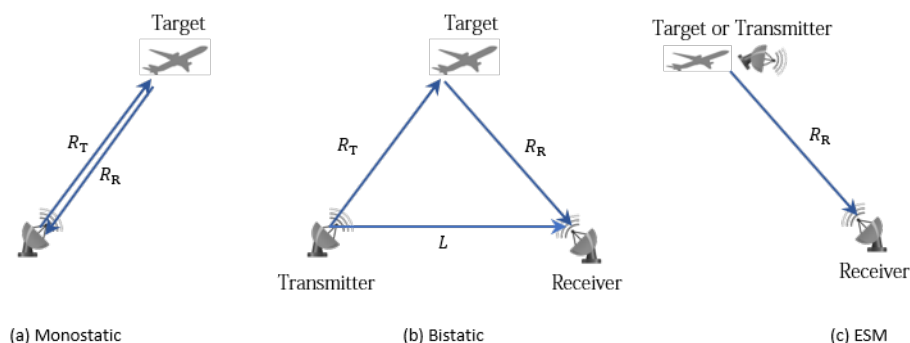

For the monostatic detection mode, the transmitter and the receiver are collocated, as shown in figure (a). In this mode, the range measurement R can be expressed as $R = R_T = R_R$, where R_T and R_R are the ranges from the transmitter to the target and from the target to the receiver, respectively. In the radar sensor, the range measurement is $R = ct/2$, where c is the speed of light and t is the total time of the signal transmission. Other than the range measurement, a monostatic sensor can also optionally report range-rate, azimuth, and elevation measurements of the target.

For the bistatic detection mode, the transmitter and the receiver are separated by a distance L . As shown in figure (b), the signal is emitted from the transmitter, reflected from the target, and received by the receiver. The bistatic range measurement R_b is defined as $R_b = R_T + R_R - L$. In the radar sensor, the bistatic range measurement is obtained by $R_b = c\Delta t$, where Δt is the time difference between the receiver receiving the direct signal from the transmitter and receiving the reflected signal from the target. Other than the bistatic range measurement, a bistatic sensor can also optionally report the bistatic range-rate, azimuth, and elevation measurements of the target. Since the bistatic range and the two bearing angles (azimuth and elevation) do not correspond to the same position vector, they cannot be combined into a position vector and reported in a Cartesian coordinate system. As a result, the measurements of a bistatic sensor can only be reported in a spherical coordinate system.

For the ESM detection mode, the receiver can only receive a signal reflected from the target or directly emitted from the transmitter, as shown in figure (c). Therefore, the only available measurements are azimuth and elevation of the target or transmitter. These measurements can only be reported in a spherical coordinate system.

Detection and Track State Coordinates

The format of the measurement states or track states is determined by the specifications of the `HasRangeRate`, `HasElevation`, `HasINS`, `TaregetReportFormat`, and `DetectionCoordinates` properties.

There are two general types of detection or track coordinates:

- Cartesian coordinates — Enabled by specifying the `DetectionCoordinates` property as `'Body'`, `'Scenario'`, or `'Sensor_rectangular'`. The complete form of a Cartesian state is `[x; y; z; vx; vy; vz]`, where `x`, `y`, and `z` are the Cartesian positions and `vx`, `vy`, and `vz` are the corresponding velocities. You can only set `DetectionCoordinates` as `'Scenario'` when the `HasINS` property is set to `true`, so that the sensor can transform sensor detections or tracks to the scenario frame.
- Spherical coordinates — Enabled by specifying the `DetectionCoordinates` property as `'Sensor_spherical'`. The complete form of a spherical state is `[az; el; rng; rr]`, where `az`, `el`, `rng`, and `rr` represent azimuth angle, elevation angle, range, and range rate, respectively. When the `DetectionMode` property of the sensor is set to `'ESM'` or `'Bistatic'`, the sensor can only report detections in the `'Sensor_spherical'` frame.

When the `HasRangeRate` property is set to `false`, `vx`, `vy`, and `vz` are removed from the Cartesian state coordinates and `rr` is removed from the spherical coordinates.

When the `HasElevation` property is set to `false`, `z` and `vz` are removed from the Cartesian state coordinates and `el` is removed from the spherical coordinates.

When the `DetectionMode` property is set to `'ESM'`, the sensor can only report detections in the `'Sensor_spherical'` frame as `[az; el]`.

When the `DetectionMode` property is set to `'Bistatic'`, the sensor can only report detections in the `'Sensor_spherical'` frame as `[az; el; rng; rr]`. Here, `rng` and `rr` are the bistatic range and range rate, respectively.

Measurement Parameters

The `MeasurementParameters` property of an output detection consists of an array of structures that describes a sequence of coordinate transformations from a child frame to a parent frame, or the inverse transformations. In most cases, the longest required sequence of transformations is `Sensor` → `Platform` → `Scenario`.

If the detections are reported in sensor spherical coordinates and `HasINS` is set to `false`, then the sequence consists only of one transformation from sensor to platform. In this transformation, the `OriginPosition` is same as the `MountingLocation` property of the sensor. The `Orientation` consists of two consecutive rotations. The first rotation, corresponding to the `MountingAngles` property of the sensor, accounts for the rotation from the platform frame (P) to the sensor mounting frame (M). The second rotation, corresponding to the azimuth and elevation angles of the sensor, accounts for the rotation from the sensor mounting frame (M) to the sensor scanning frame (S). In the S frame, the x -direction is the boresight direction, and the y -direction lies within the x - y plane of the sensor mounting frame (M).

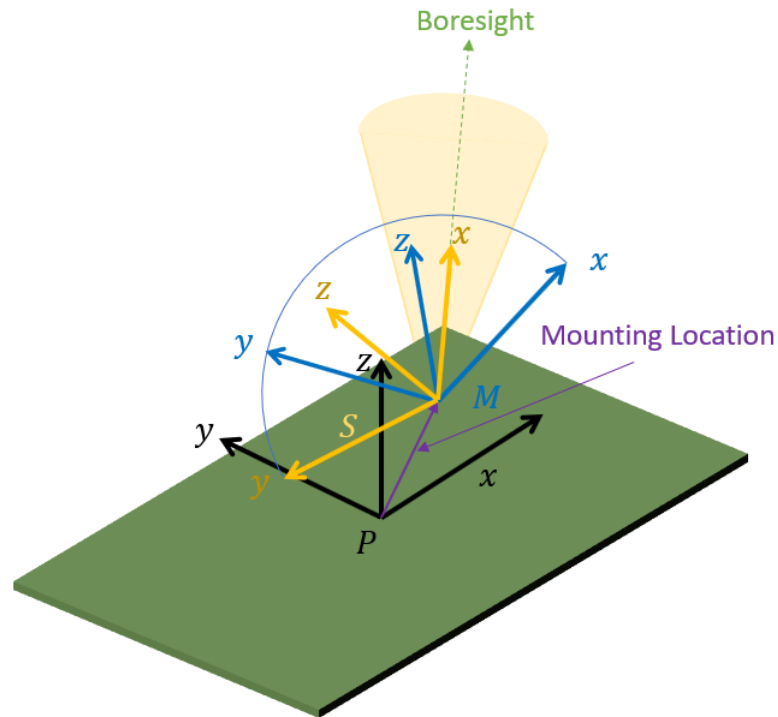

If `HasINS` is `true`, the sequence of transformations consists of two transformations: first from the scenario frame to the platform frame, and then from the platform frame to the sensor scanning frame. In the first transformation, the `Orientation` is the rotation from the scenario frame to the platform frame, and the `OriginPosition` is the position of the platform frame origin relative to the scenario frame.

If the detections are reported in platform rectangular coordinates and `HasINS` is set to `false`, the transformation consists only of the identity.

The table shows the fields of the `MeasurementParameters` structure. Not all fields have to be present in the structure. The specific set of fields and their default values can depend on the type of sensor.

Field	Description
Frame	Enumerated type indicating the frame used to report measurements. When detections are reported using a rectangular coordinate system, <code>Frame</code> is set to <code>'rectangular'</code> . When detections are reported in spherical coordinates, <code>Frame</code> is set <code>'spherical'</code> for the first structure.
OriginPosition	Position offset of the origin of the child frame relative to the parent frame, represented as a 3-by-1 vector.
OriginVelocity	Velocity offset of the origin of the child frame relative to the parent frame, represented as a 3-by-1 vector.

Orientation	3-by-3 real-valued orthonormal frame rotation matrix. The direction of the rotation depends on the <code>IsParentToChild</code> field.
IsParentToChild	A logical scalar indicating if <code>Orientation</code> performs a frame rotation from the parent coordinate frame to the child coordinate frame. If <code>false</code> , <code>Orientation</code> instead performs a frame rotation from the child coordinate frame to the parent coordinate frame.
HasElevation	A logical scalar indicating if elevation is included in the measurement. For measurements reported in a rectangular frame, if <code>HasElevation</code> is <code>false</code> , the measurements are reported assuming 0 degrees of elevation.
HasAzimuth	A logical scalar indicating if azimuth is included in the measurement.
HasRange	A logical scalar indicating if range is included in the measurement.
HasVelocity	A logical scalar indicating if the reported detections include velocity measurements. For measurements reported in a rectangular frame, if <code>HasVelocity</code> is <code>false</code> , the measurements are reported as <code>[x y z]</code> . If <code>HasVelocity</code> is <code>true</code> , measurements are reported as <code>[x y z vx vy vz]</code> .

References

- [1] Doerry, Armin W. "Earth Curvature and Atmospheric Refraction Effects on Radar Signal Propagation." Sandia Report SAND2012-10690, Sandia National Laboratories, Albuquerque, NM, January 2013. <https://prod.sandia.gov/techlib-noauth/access-control.cgi/2012/1210690.pdf>.
- [2] Doerry, Armin W. "Motion Measurement for Synthetic Aperture Radar." Sandia Report SAND2015-20818, Sandia National Laboratories, Albuquerque, NM, January 2015. <https://pdfs.semanticscholar.org/f8f8/cd6de8042a7a948d611bcfe3b79c48aa9dfa.pdf>.

See Also

radarChannel | radarEmission | radarEmitter | rcsSignature | trackerGNN | trackingScenario

Topics

"Introduction to Statistical Radar Models for Object Tracking"
 "Scanning Radar Mode Configuration"
 "Introduction to Tracking Scenario and Simulating Sensor Detections"

Introduced in R2021a

insSensor

Inertial navigation system and GNSS/GPS simulation model

Description

The `insSensor` System object models a device that fuses measurements from an inertial navigation system (INS) and global navigation satellite system (GNSS) such as a GPS, and outputs the fused measurements.

To output fused INS and GNSS measurements:

- 1 Create the `insSensor` object and set its properties.
- 2 Call the object with arguments, as if it were a function.

To learn more about how System objects work, see [What Are System Objects?](#).

Creation

Syntax

```
INS = insSensor
INS = insSensor(Name,Value)
```

Description

`INS = insSensor` returns a System object, `INS`, that models a device that outputs measurements from an INS and GNSS.

`INS = insSensor(Name,Value)` sets properties on page 3-119 using one or more name-value pairs. Unspecified properties have default values. Enclose each property name in quotes.

Properties

Unless otherwise indicated, properties are *nontunable*, which means you cannot change their values after calling the object. Objects lock when you call them, and the `release` function unlocks them.

If a property is *tunable*, you can change its value at any time.

For more information on changing property values, see [System Design in MATLAB Using System Objects](#).

MountingLocation — Location of sensor on platform (m)

`[0 0 0]` (default) | three-element real-valued vector of form `[x y z]`

Location of the sensor on the platform, in meters, specified as a three-element real-valued vector of the form `[x y z]`. The vector defines the offset of the sensor origin from the origin of the platform.

Tunable: Yes

Data Types: `single` | `double`

RollAccuracy — Accuracy of roll measurement (deg)

0.2 (default) | nonnegative real scalar

Accuracy of the roll measurement of the sensor body, in degrees, specified as a nonnegative real scalar.

Roll is the rotation around the x-axis of the sensor body. Roll noise is modeled as a white noise process. `RollAccuracy` sets the standard deviation of the roll measurement noise.

Tunable: Yes

Data Types: `single` | `double`

PitchAccuracy — Accuracy of pitch measurement (deg)

0.2 (default) | nonnegative real scalar

Accuracy of the pitch measurement of the sensor body, in degrees, specified as a nonnegative real scalar.

Pitch is the rotation around the y-axis of the sensor body. Pitch noise is modeled as a white noise process. `PitchAccuracy` defines the standard deviation of the pitch measurement noise.

Tunable: Yes

Data Types: `single` | `double`

YawAccuracy — Accuracy of yaw measurement (deg)

1 (default) | nonnegative real scalar

Accuracy of the yaw measurement of the sensor body, in degrees, specified as a nonnegative real scalar.

Yaw is the rotation around the z-axis of the sensor body. Yaw noise is modeled as a white noise process. `YawAccuracy` defines the standard deviation of the yaw measurement noise.

Tunable: Yes

Data Types: `single` | `double`

PositionAccuracy — Accuracy of position measurement (m)

[1 1 1] (default) | nonnegative real scalar | three-element real-valued vector

Accuracy of the position measurement of the sensor body, in meters, specified as a nonnegative real scalar or a three-element real-valued vector. The elements of the vector set the accuracy of the x-, y-, and z-position measurements, respectively. If you specify `PositionAccuracy` as a scalar value, then the object sets the accuracy of all three positions to this value.

Position noise is modeled as a white noise process. `PositionAccuracy` defines the standard deviation of the position measurement noise.

Tunable: Yes

Data Types: `single` | `double`

VelocityAccuracy — Accuracy of velocity measurement (m/s)

0.05 (default) | nonnegative real scalar

Accuracy of the velocity measurement of the sensor body, in meters per second, specified as a nonnegative real scalar.

Velocity noise is modeled as a white noise process. `VelocityAccuracy` defines the standard deviation of the velocity measurement noise.

Tunable: Yes

Data Types: `single` | `double`

AccelerationAccuracy — Accuracy of acceleration measurement (m/s²)

0 (default) | nonnegative real scalar

Accuracy of the acceleration measurement of the sensor body, in meters per second, specified as a nonnegative real scalar.

Acceleration noise is modeled as a white noise process. `AccelerationAccuracy` defines the standard deviation of the acceleration measurement noise.

Tunable: Yes

Data Types: `single` | `double`

AngularVelocityAccuracy — Accuracy of angular velocity measurement (deg/s)

0 (default) | nonnegative real scalar

Accuracy of the angular velocity measurement of the sensor body, in meters per second, specified as a nonnegative real scalar.

Angular velocity is modeled as a white noise process. `AngularVelocityAccuracy` defines the standard deviation of the acceleration measurement noise.

Tunable: Yes

Data Types: `single` | `double`

TimeInput — Enable input of simulation time

`false` or 0 (default) | `true` or 1

Enable input of simulation time, specified as a logical 0 (`false`) or 1 (`true`). Set this property to `true` to input the simulation time by using the `simTime` argument.

Tunable: No

Data Types: `logical`

HasGNSSFix — Enable GNSS fix

`true` or 1 (default) | `false` or 0

Enable GNSS fix, specified as a logical 1 (`true`) or 0 (`false`). Set this property to `false` to simulate the loss of a GNSS receiver fix. When a GNSS receiver fix is lost, position measurements drift at a rate specified by the `PositionErrorFactor` property.

Tunable: Yes

Dependencies

To enable this property, set `TimeInput` to `true`.

Data Types: `logical`

PositionErrorFactor — Position error factor without GNSS fix

`[0 0 0]` (default) | nonnegative scalar | 1-by-3 vector of scalars

Position error factor without GNSS fix, specified as a scalar or a 1-by-3 vector of scalars.

When the `HasGNSSFix` property is set to `false`, the position error grows at a quadratic rate due to constant bias in the accelerometer. The position error for a position component $E(t)$ can be expressed as $E(t) = 1/2\alpha t^2$, where α is the position error factor for the corresponding component and t is the time since the GNSS fix is lost. While running, the object computes t based on the `simTime` input. The computed $E(t)$ values for the x , y , and z components are added to the corresponding position components of the `gTruth` input.

Tunable: Yes

Dependencies

To enable this property, set `TimeInput` to `true` and `HasGNSSFix` to `false`.

Data Types: `single` | `double`

RandomStream — Random number source

`'Global stream'` (default) | `'mt19937ar with seed'`

Random number source, specified as one of these options:

- `'Global stream'` -- Generate random numbers using the current global random number stream.
- `'mt19937ar with seed'` -- Generate random numbers using the mt19937ar algorithm, with the seed specified by the `Seed` property.

Data Types: `char` | `string`

Seed — Initial seed

67 (default) | nonnegative integer

Initial seed of the mt19937ar random number generator algorithm, specified as a nonnegative integer.

Dependencies

To enable this property, set `RandomStream` to `'mt19937ar with seed'`.

Data Types: `single` | `double` | `int8` | `int16` | `int32` | `int64` | `uint8` | `uint16` | `uint32` | `uint64`

Usage**Syntax**

```
measurement = INS(gTruth)  
measurement = INS(gTruth, simTime)
```

Description

`measurement = INS(gTruth)` models the data received from an INS sensor reading and GNSS sensor reading. The output measurement is based on the inertial ground-truth state of the sensor body, `gTruth`.

`measurement = INS(gTruth, simTime)` additionally specifies the time of simulation, `simTime`. To enable this syntax, set the `TimeInput` property to `true`.

Input Arguments

gTruth — Inertial ground-truth state of sensor body

structure

Inertial ground-truth state of sensor body, in local Cartesian coordinates, specified as a structure containing these fields:

Field	Description
'Position'	Position, in meters, specified as a real, finite N -by-3 matrix of $[x \ y \ z]$ vectors. N is the number of samples in the current frame.
'Velocity'	Velocity (v), in meters per second, specified as a real, finite N -by-3 matrix of $[v_x \ v_y \ v_z]$ vector. N is the number of samples in the current frame.
'Orientation'	Orientation with respect to the local Cartesian coordinate system, specified as one of these options: <ul style="list-style-type: none"> N-element column vector of quaternion objects 3-by-3-by-N array of rotation matrices N-by-3 matrix of $[x_{\text{roll}} \ y_{\text{pitch}} \ z_{\text{yaw}}]$ angles in degrees Each quaternion or rotation matrix is a frame rotation from the local Cartesian coordinate system to the current sensor body coordinate system. N is the number of samples in the current frame.
'Acceleration'	Acceleration (a), in meters per second squared, specified as a real, finite N -by-3 matrix of $[a_x \ a_y \ a_z]$ vectors. N is the number of samples in the current frame.
'AngularVelocity'	Angular velocity (ω), in meters per second squared, specified as a real, finite N -by-3 matrix of $[\omega_x \ \omega_y \ \omega_z]$ vectors. N is the number of samples in the current frame.

The field values must be of type `double` or `single`.

The `Position`, `Velocity`, and `Orientation` fields are required. The other fields are optional.

```
Example: struct('Position',[0 0 0],'Velocity',[0 0
0],'Orientation',quaternion([1 0 0 0]))
```

simTime – Simulation time

nonnegative real scalar

Simulation time, in seconds, specified as a nonnegative real scalar.

Data Types: single | double

Output Arguments

measurement – Measurement of sensor body motion

structure

Measurement of the sensor body motion, in local Cartesian coordinates, returned as a structure containing these fields:

Field	Description
'Position'	Position, in meters, specified as a real, finite N -by-3 matrix of $[x\ y\ z]$ vectors. N is the number of samples in the current frame.
'Velocity'	Velocity (v), in meters per second, specified as a real, finite N -by-3 matrix of $[v_x\ v_y\ v_z]$ vector. N is the number of samples in the current frame.
'Orientation'	Orientation with respect to the local Cartesian coordinate system, specified as one of these options: <ul style="list-style-type: none"> • N-element column vector of quaternion objects • 3-by-3-by-N array of rotation matrices • N-by-3 matrix of $[x_{roll}\ y_{pitch}\ z_{yaw}]$ angles in degrees Each quaternion or rotation matrix is a frame rotation from the local Cartesian coordinate system to the current sensor body coordinate system. N is the number of samples in the current frame.
'Acceleration'	Acceleration (a), in meters per second squared, specified as a real, finite N -by-3 matrix of $[a_x\ a_y\ a_z]$ vectors. N is the number of samples in the current frame.
'AngularVelocity'	Angular velocity (ω), in meters per second squared, specified as a real, finite N -by-3 matrix of $[\omega_x\ \omega_y\ \omega_z]$ vectors. N is the number of samples in the current frame.

The returned field values are of type double or single and are of the same type as the corresponding field values in the gTruth input.

Object Functions

To use an object function, specify the System object as the first input argument. For example, to release system resources of a System object named `obj`, use this syntax:

```
release(obj)
```

Specific to `insSensor`

`perturbations` Perturbation defined on object
`perturb` Apply perturbations to object

Common to All System Objects

`step` Run System object algorithm
`clone` Create duplicate System object
`isLocked` Determine if System object is in use
`reset` Reset internal states of System object
`release` Release resources and allow changes to System object property values and input characteristics

Examples

Generate INS Measurements from Stationary Input

Create a motion structure that defines a stationary position at the local north-east-down (NED) origin. Because the platform is stationary, you need to define only a single sample. Assume the ground-truth motion is sampled for 10 seconds with a 100 Hz sample rate. Create a default `insSensor` System object™. Preallocate variables to hold output from the `insSensor` object.

```
Fs = 100;
duration = 10;
numSamples = Fs*duration;

motion = struct( ...
    'Position',zeros(1,3), ...
    'Velocity',zeros(1,3), ...
    'Orientation',ones(1,1,'quaternion'));

INS = insSensor;

positionMeasurements = zeros(numSamples,3);
velocityMeasurements = zeros(numSamples,3);
orientationMeasurements = zeros(numSamples,1,'quaternion');
```

In a loop, call `INS` with the stationary motion structure to return the position, velocity, and orientation measurements in the local NED coordinate system. Log the position, velocity, and orientation measurements.

```
for i = 1:numSamples

    measurements = INS(motion);

    positionMeasurements(i,:) = measurements.Position;
    velocityMeasurements(i,:) = measurements.Velocity;
```

```
orientationMeasurements(i) = measurements.Orientation;
```

```
end
```

Convert the orientation from quaternions to Euler angles for visualization purposes. Plot the position, velocity, and orientation measurements over time.

```
orientationMeasurements = eulerd(orientationMeasurements, 'ZYX', 'frame');
```

```
t = (0:(numSamples-1))/Fs;
```

```
subplot(3,1,1)
plot(t,positionMeasurements)
title('Position')
xlabel('Time (s)')
ylabel('Position (m)')
legend('North', 'East', 'Down')
```

```
subplot(3,1,2)
plot(t,velocityMeasurements)
title('Velocity')
xlabel('Time (s)')
ylabel('Velocity (m/s)')
legend('North', 'East', 'Down')
```

```
subplot(3,1,3)
plot(t,orientationMeasurements)
title('Orientation')
xlabel('Time (s)')
ylabel('Rotation (degrees)')
legend('Roll', 'Pitch', 'Yaw')
```

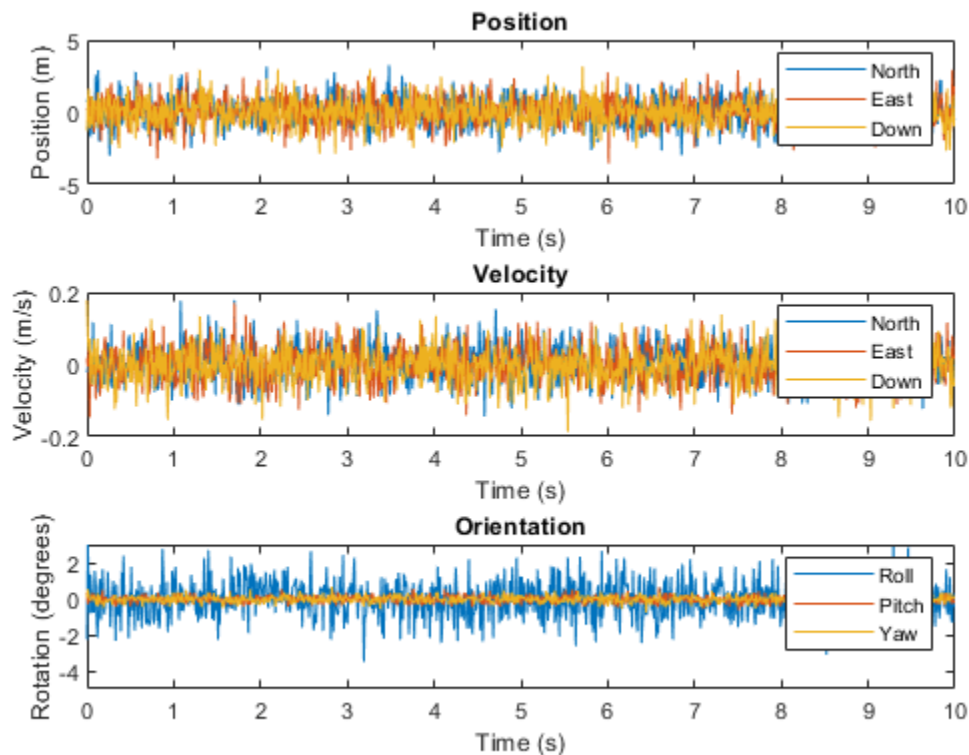
Generate INS Measurements for Tracking Scenario

Generate INS measurements using the `insSensor System` object™. Use `waypointTrajectory` to generate the ground-truth path. Use `trackingScenario` to organize the simulation and visualize the motion.

Specify the ground-truth trajectory as a figure-eight path in the North-East plane. Use a 50 Hz sample rate and 5 second duration.

```

Fs = 50;
duration = 5;
numSamples = Fs*duration;
t = (0:(numSamples-1)).'/Fs;

a = 2;

x = a.*sqrt(2).*cos(t) ./ (sin(t).^2 + 1);
y = sin(t) .* x;
z = zeros(numSamples,1);

waypoints = [x,y,z];

path = waypointTrajectory('Waypoints',waypoints,'TimeOfArrival',t);

```

Create an `insSensor` System object to model receiving INS data. Set the `PositionAccuracy` to 0.1.

```
ins = insSensor('PositionAccuracy',0.1);
```

Create a tracking scenario with a single platform whose motion is defined by path.

```
scenario = trackingScenario('UpdateRate',Fs);  
quadcopter = platform(scenario);  
quadcopter.Trajectory = path;
```

Create a theater plot to visualize the ground-truth quadcopter motion and the quadcopter motion measurements modeled by `insSensor`.

```
tp = theaterPlot('XLimits',[-3, 3],'YLimits', [-3, 3]);  
quadPlotter = platformPlotter(tp, ...  
    'DisplayName', 'Ground-Truth Motion', ...  
    'Marker', 's', ...  
    'MarkerFaceColor','blue');  
insPlotter = detectionPlotter(tp, ...  
    'DisplayName','INS Measurement', ...  
    'Marker','d', ...  
    'MarkerFaceColor','red');
```

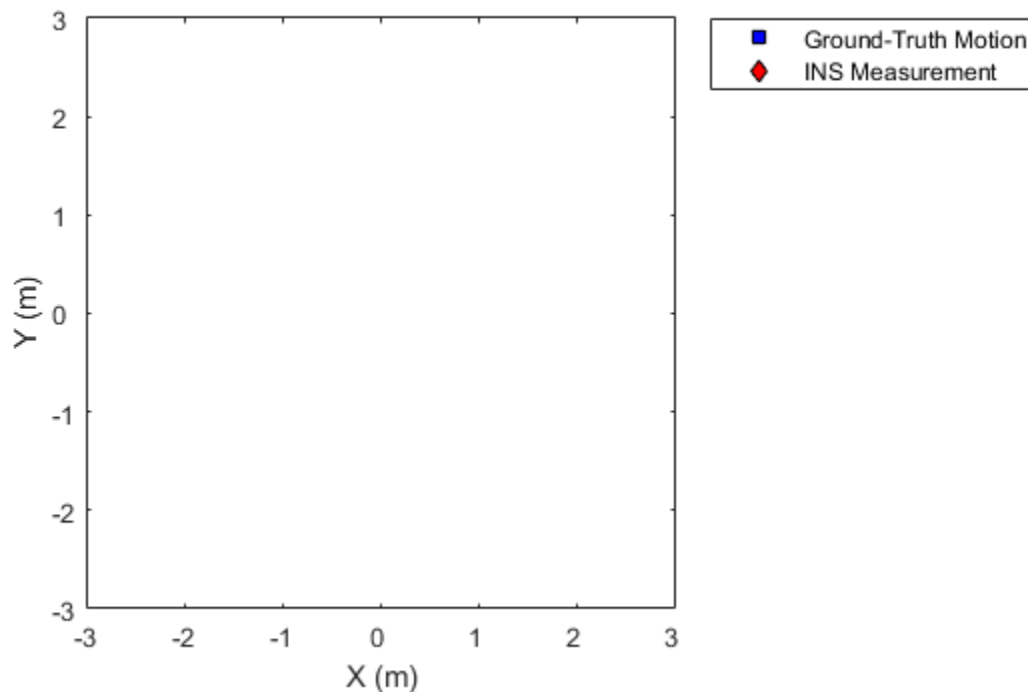

In a loop, advance the scenario until it is complete. For each time step, get the current motion sample, model INS measurements for the motion, and then plot the result.

```
while advance(scenario)  
    motion = platformPoses(scenario,'quaternion');
```

```

insMeas = ins(motion);

plotPlatform(quadPlotter,motion.Position);
plotDetection(insPlotter,insMeas.Position);

pause(1/scenario.UpdateRate)
end

```

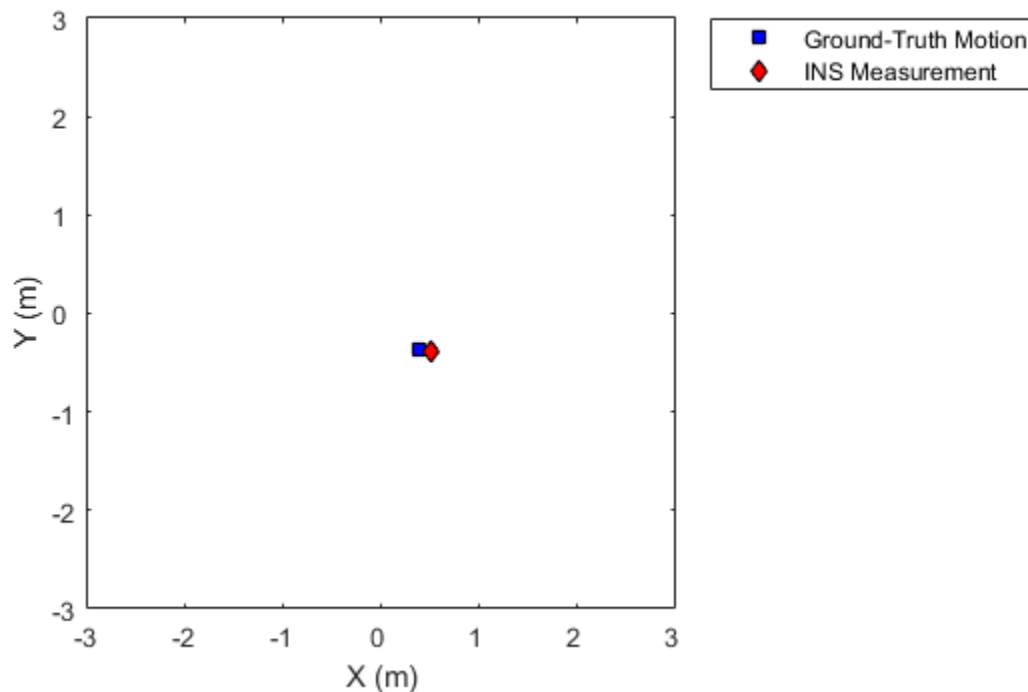

Generate INS Measurements for a Turning Platform

Generate INS measurements using the `insSensor System` object™. Use `waypointTrajectory` to generate the ground-truth path.

Specify a ground-truth orientation that begins with the sensor body x -axis aligned with North and ends with the sensor body x -axis aligned with East. Specify waypoints for an arc trajectory and a time-of-arrival vector for the corresponding waypoints. Use a 100 Hz sample rate. Create a `waypointTrajectory System` object with the waypoint constraints, and set `SamplesPerFrame` so that the entire trajectory is output with one call.

```

eulerAngles = [0,0,0; ...
               0,0,0; ...
               90,0,0; ...
               90,0,0];

```

```
orientation = quaternion(eulerAngles, 'eulerd', 'ZYX', 'frame');

r = 20;
waypoints = [0,0,0; ...
            100,0,0; ...
            100+r,r,0; ...
            100+r,100+r,0];

toa = [0,10,10+(2*pi*r/4),20+(2*pi*r/4)];

Fs = 100;
numSamples = floor(Fs*toa(end));

path = waypointTrajectory('Waypoints', waypoints, ...
    'TimeOfArrival', toa, ...
    'Orientation', orientation, ...
    'SampleRate', Fs, ...
    'SamplesPerFrame', numSamples);
```

Create an `insSensor` System object to model receiving INS data. Set the `PositionAccuracy` to 0.1.

```
ins = insSensor('PositionAccuracy', 0.1);
```

Call the waypoint trajectory object, `path`, to generate the ground-truth motion. Call the INS simulator, `ins`, with the ground-truth motion to generate INS measurements.

```
[motion.Position, motion.Orientation, motion.Velocity] = path();
insMeas = ins(motion);
```

Convert the orientation returned by `ins` to Euler angles in degrees for visualization purposes. Plot the full path and orientation over time.

```
orientationMeasurementEuler = eulerd(insMeas.Orientation, 'ZYX', 'frame');

subplot(2,1,1)
plot(insMeas.Position(:,1), insMeas.Position(:,2));
title('Path')
xlabel('North (m)')
ylabel('East (m)')

subplot(2,1,2)
t = (0:(numSamples-1)).'/Fs;
plot(t, orientationMeasurementEuler(:,1), ...
    t, orientationMeasurementEuler(:,2), ...
    t, orientationMeasurementEuler(:,3));
title('Orientation')
legend('Yaw', 'Pitch', 'Roll')
xlabel('Time (s)')
ylabel('Rotation (degrees)')
```

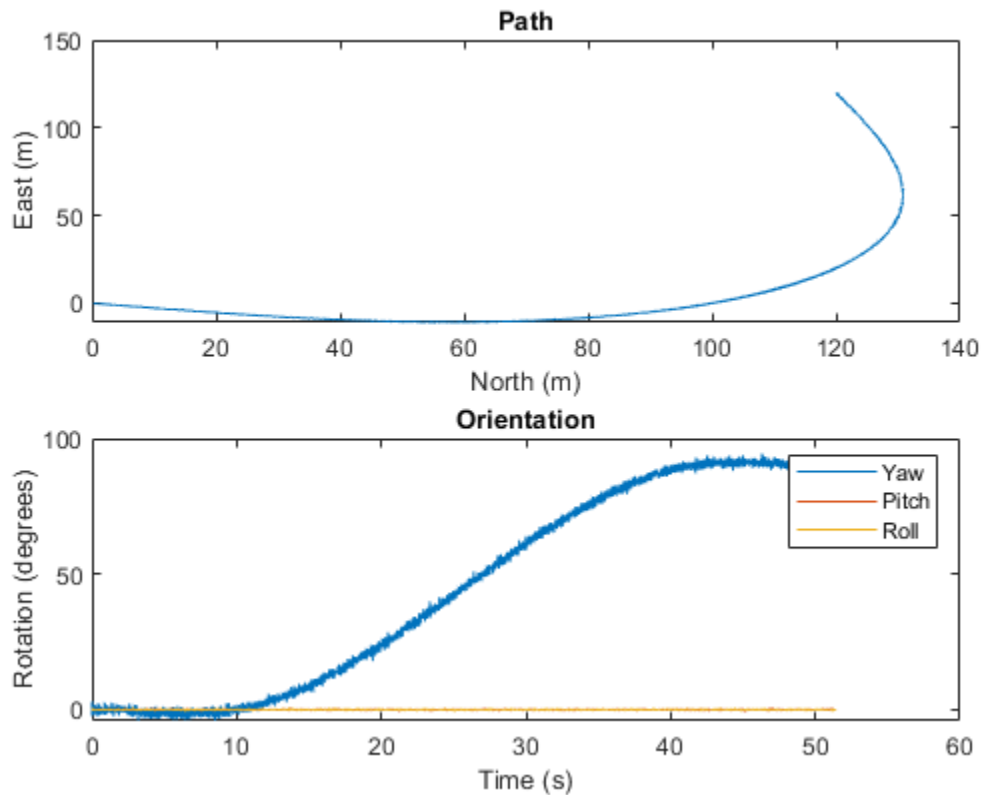

Extended Capabilities

C/C++ Code Generation

Generate C and C++ code using MATLAB® Coder™.

Usage notes and limitations:

See “System Objects in MATLAB Code Generation” (MATLAB Coder).

See Also

Objects

gpsSensor | imuSensor | trackingScenario

Topics

“Model IMU, GPS, and INS/GPS”

Introduced in R2018b

gpsSensor

GPS receiver simulation model

Description

The `gpsSensor` System object models data output from a Global Positioning System (GPS) receiver.

To model a GPS receiver:

- 1 Create the `gpsSensor` object and set its properties.
- 2 Call the object with arguments, as if it were a function.

To learn more about how System objects work, see [What Are System Objects?](#).

Creation

Syntax

```
GPS = gpsSensor
GPS = gpsSensor('ReferenceFrame',RF)
GPS = gpsSensor( ____,Name,Value)
```

Description

`GPS = gpsSensor` returns a `gpsSensor` System object that computes a Global Positioning System receiver reading based on a local position and velocity input signal. The default reference position in geodetic coordinates is

- latitude: 0° N
- longitude: 0° E
- altitude: 0 m

`GPS = gpsSensor('ReferenceFrame',RF)` returns a `gpsSensor` System object that computes a global positioning system receiver reading relative to the reference frame `RF`. Specify `RF` as `'NED'` (North-East-Down) or `'ENU'` (East-North-Up). The default value is `'NED'`.

`GPS = gpsSensor(____,Name,Value)` sets each property `Name` to the specified `Value`. Unspecified properties have default values.

Properties

Unless otherwise indicated, properties are *nontunable*, which means you cannot change their values after calling the object. Objects lock when you call them, and the `release` function unlocks them.

If a property is *tunable*, you can change its value at any time.

For more information on changing property values, see System Design in MATLAB Using System Objects.

SampleRate — Update rate of receiver (Hz)

1 (default) | positive real scalar

Update rate of the receiver in Hz, specified as a positive real scalar.

Data Types: `single` | `double`

ReferenceLocation — Origin of local navigation reference frame

[0 0 0] (default) | [degrees degrees meters]

Reference location, specified as a 3-element row vector in geodetic coordinates (latitude, longitude, and altitude). Altitude is the height above the reference ellipsoid model, WGS84. The reference location is in [degrees degrees meters]. The degree format is decimal degrees (DD).

Data Types: `single` | `double`

PositionInputFormat — Position coordinate input format

'Local' (default) | 'Geodetic'

Position coordinate input format, specified as 'Local' or 'Geodetic'.

- If you set the property as 'Local', then you need to specify the `truePosition` input as Cartesian coordinates with respect to the local navigation frame whose origin is fixed and defined by the `ReferenceLocation` property. Additionally, when you specify the `trueVelocity` input, you need to specify it with respect to this local navigation frame.
- If you set the property as 'Geodetic', then you need to specify the `truePosition` input as geodetic coordinates in latitude, longitude, and altitude. Additionally, when you specify the `trueVelocity` input, you need to specify it with respect to the navigation frame (NED or ENU) whose origin corresponds to the `truePosition` input. When setting the property as 'Geodetic', the `gpsSensor` object neglects the `ReferenceLocation` property.

Data Types: `character` `vector`

HorizontalPositionAccuracy — Horizontal position accuracy (m)

1.6 (default) | nonnegative real scalar

Horizontal position accuracy in meters, specified as a nonnegative real scalar. The horizontal position accuracy specifies the standard deviation of the noise in the horizontal position measurement.

Tunable: Yes

Data Types: `single` | `double`

VerticalPositionAccuracy — Vertical position accuracy (m)

3 (default) | nonnegative real scalar

Vertical position accuracy in meters, specified as a nonnegative real scalar. The vertical position accuracy specifies the standard deviation of the noise in the vertical position measurement.

Tunable: Yes

Data Types: `single` | `double`

VelocityAccuracy — Velocity accuracy (m/s)

0.1 (default) | nonnegative real scalar

Velocity accuracy in meters per second, specified as a nonnegative real scalar. The velocity accuracy specifies the standard deviation of the noise in the velocity measurement.

Tunable: Yes

Data Types: `single` | `double`

DecayFactor — Global position noise decay factor

0.999 (default) | scalar in the range [0,1]

Global position noise decay factor, specified as a scalar in the range [0,1].

A decay factor of 0 models the global position noise as a white noise process. A decay factor of 1 models the global position noise as a random walk process.

Tunable: Yes

Data Types: `single` | `double`

RandomStream — Random number source

'Global stream' (default) | 'mt19937ar with seed'

Random number source, specified as a character vector or string:

- 'Global stream' -- Random numbers are generated using the current global random number stream.
- 'mt19937ar with seed' -- Random numbers are generated using the mt19937ar algorithm with the seed specified by the `Seed` property.

Data Types: `char` | `string`

Seed — Initial seed

67 (default) | nonnegative integer scalar

Initial seed of an mt19937ar random number generator algorithm, specified as a nonnegative integer scalar.

Dependencies

To enable this property, set `RandomStream` to 'mt19937ar with seed'.

Data Types: `single` | `double` | `int8` | `int16` | `int32` | `int64` | `uint8` | `uint16` | `uint32` | `uint64`

Usage**Syntax**

```
[position,velocity,groundspeed,course] = GPS(truePosition,trueVelocity)
```

Description

```
[position,velocity,groundspeed,course] = GPS(truePosition,trueVelocity)
```

computes global navigation satellite system receiver readings from the position and velocity inputs.

Input Arguments

truePosition — Position of GPS receiver in navigation coordinate system

N-by-3 matrix

Position of the GPS receiver in the navigation coordinate system, specified as a real finite *N*-by-3 matrix. *N* is the number of samples in the current frame.

- When the `PositionInputFormat` property is specified as 'Local', specify `truePosition` as Cartesian coordinates with respect to the local navigation frame whose origin is fixed at `ReferenceLocation`.
- When the `PositionInputFormat` property is specified as 'Geodetic', specify `truePosition` as geodetic coordinates in [`latitude`, `longitude`, `altitude`]. `latitude` and `longitude` are in meters. `altitude` is the height above the WGS84 ellipsoid model in meters.

Data Types: `single` | `double`

trueVelocity — Velocity of GPS receiver in navigation coordinate system (m/s)

N-by-3 matrix

Velocity of GPS receiver in the navigation coordinate system in meters per second, specified as a real finite *N*-by-3 matrix. *N* is the number of samples in the current frame.

- When the `PositionInputFormat` property is specified as 'Local', specify `trueVelocity` with respect to the local navigation frame (NED or ENU) whose origin is fixed at `ReferenceLocation`.
- When the `PositionInputFormat` property is specified as 'Geodetic', specify `trueVelocity` with respect to the navigation frame (NED or ENU) whose origin corresponds to the `truePosition` input.

Data Types: `single` | `double`

Output Arguments

position — Position in LLA coordinate system

N-by-3 matrix

Position of the GPS receiver in the geodetic latitude, longitude, and altitude (LLA) coordinate system, returned as a real finite *N*-by-3 array. Latitude and longitude are in degrees with North and East being positive. Altitude is in meters.

N is the number of samples in the current frame.

Data Types: `single` | `double`

velocity — Velocity in local navigation coordinate system (m/s)

N-by-3 matrix

Velocity of the GPS receiver in the local navigation coordinate system in meters per second, returned as a real finite *N*-by-3 array. *N* is the number of samples in the current frame.

- When the `PositionInputFormat` property is specified as 'Local', the returned velocity is with respect to the local navigation frame whose origin is fixed at `ReferenceLocation`.

- When the `PositionInputFormat` property is specified as 'Geodetic', the returned velocity is with respect to the navigation frame (NED or ENU) whose origin corresponds to the position output.

Data Types: `single` | `double`

groundspeed — Magnitude of horizontal velocity in local navigation coordinate system (m/s)

N-by-1 column vector

Magnitude of the horizontal velocity of the GPS receiver in the local navigation coordinate system in meters per second, returned as a real finite *N*-by-1 column vector.

N is the number of samples in the current frame.

Data Types: `single` | `double`

course — Direction of horizontal velocity in local navigation coordinate system (°)

N-by-1 column vector

Direction of the horizontal velocity of the GPS receiver in the local navigation coordinate system in degrees, returned as a real finite *N*-by-1 column of values between 0 and 360. North corresponds to 360 degrees and East corresponds to 90 degrees.

N is the number of samples in the current frame.

Data Types: `single` | `double`

Object Functions

To use an object function, specify the System object as the first input argument. For example, to release system resources of a System object named `obj`, use this syntax:

```
release(obj)
```

Common to All System Objects

<code>step</code>	Run System object algorithm
<code>release</code>	Release resources and allow changes to System object property values and input characteristics
<code>reset</code>	Reset internal states of System object

Examples

Generate GPS Position Measurements From Stationary Input

Create a `gpsSensor` System object™ to model GPS receiver data. Assume a typical one Hz sample rate and a 1000-second simulation time. Define the reference location in terms of latitude, longitude, and altitude (LLA) of Natick, MA (USA). Define the sensor as stationary by specifying the true position and velocity with zeros.

```
fs = 1;  
duration = 1000;  
numSamples = duration*fs;
```

```
refLoc = [42.2825 -71.343 53.0352];  
  
truePosition = zeros(numSamples,3);  
trueVelocity = zeros(numSamples,3);  
  
gps = gpsSensor('SampleRate', fs, 'ReferenceLocation', refLoc);
```

Call `gps` with the specified `truePosition` and `trueVelocity` to simulate receiving GPS data for a stationary platform.

```
position = gps(truePosition,trueVelocity);
```

Plot the true position and the GPS sensor readings for position.

```
t = (0:(numSamples-1))/fs;  
  
subplot(3, 1, 1)  
plot(t, position(:,1), ...  
      t, ones(numSamples)*refLoc(1))  
title('GPS Sensor Readings')  
ylabel('Latitude (degrees)')  
  
subplot(3, 1, 2)  
plot(t, position(:,2), ...  
      t, ones(numSamples)*refLoc(2))  
ylabel('Longitude (degrees)')  
  
subplot(3, 1, 3)  
plot(t, position(:,3), ...  
      t, ones(numSamples)*refLoc(3))  
ylabel('Altitude (m)')  
xlabel('Time (s)')
```

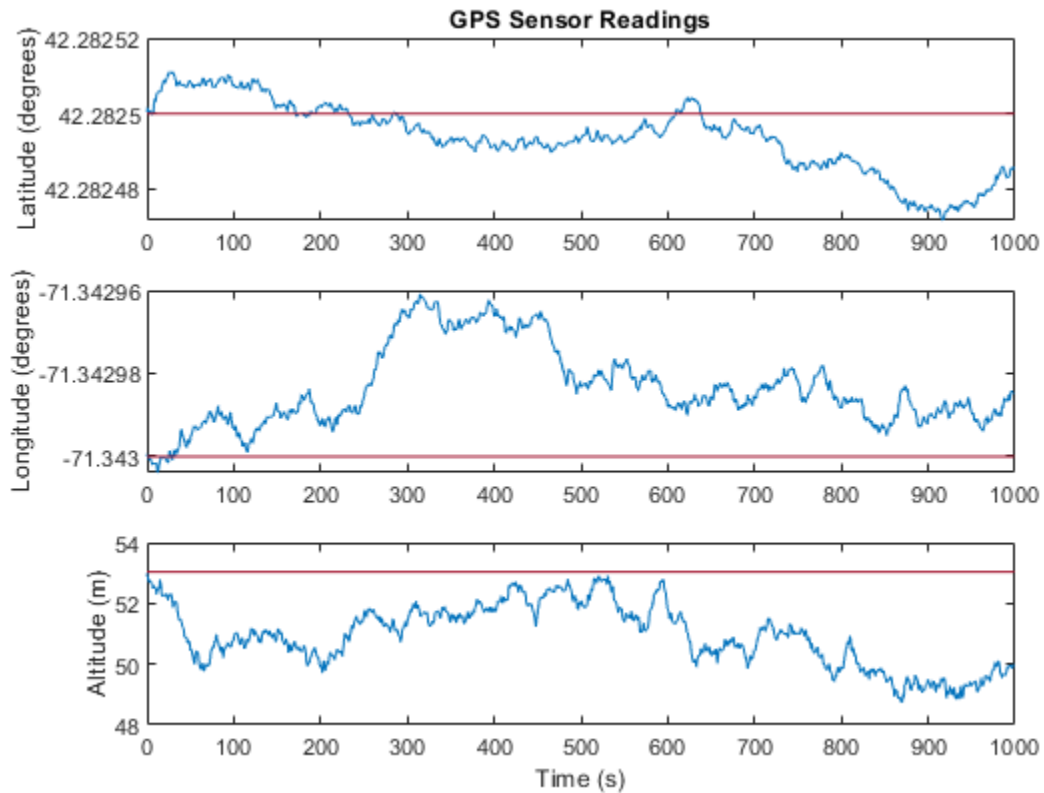

The position readings have noise controlled by `HorizontalPositionAccuracy`, `VerticalPositionAccuracy`, `VelocityAccuracy`, and `DecayFactor`. The `DecayFactor` property controls the drift in the noise model. By default, `DecayFactor` is set to `0.999`, which approaches a random walk process. To observe the effect of the `DecayFactor` property:

- 1 Reset the `gps` object.
- 2 Set `DecayFactor` to `0.5`.
- 3 Call `gps` with variables specifying a stationary position.
- 4 Plot the results.

The GPS position readings now oscillate around the true position.

```

reset(gps)
gps.DecayFactor = 0.5;
position = gps(truePosition,trueVelocity);

subplot(3, 1, 1)
plot(t, position(:,1), ...
     t, ones(numSamples)*refLoc(1))
title('GPS Sensor Readings - Decay Factor = 0.5')
ylabel('Latitude (degrees)')

subplot(3, 1, 2)
plot(t, position(:,2), ...
     t, ones(numSamples)*refLoc(2))
ylabel('Longitude (degrees)')

```

```

subplot(3, 1, 3)
plot(t, position(:,3), ...
      t, ones(numSamples)*refLoc(3))
ylabel('Altitude (m)')
xlabel('Time (s)')

```

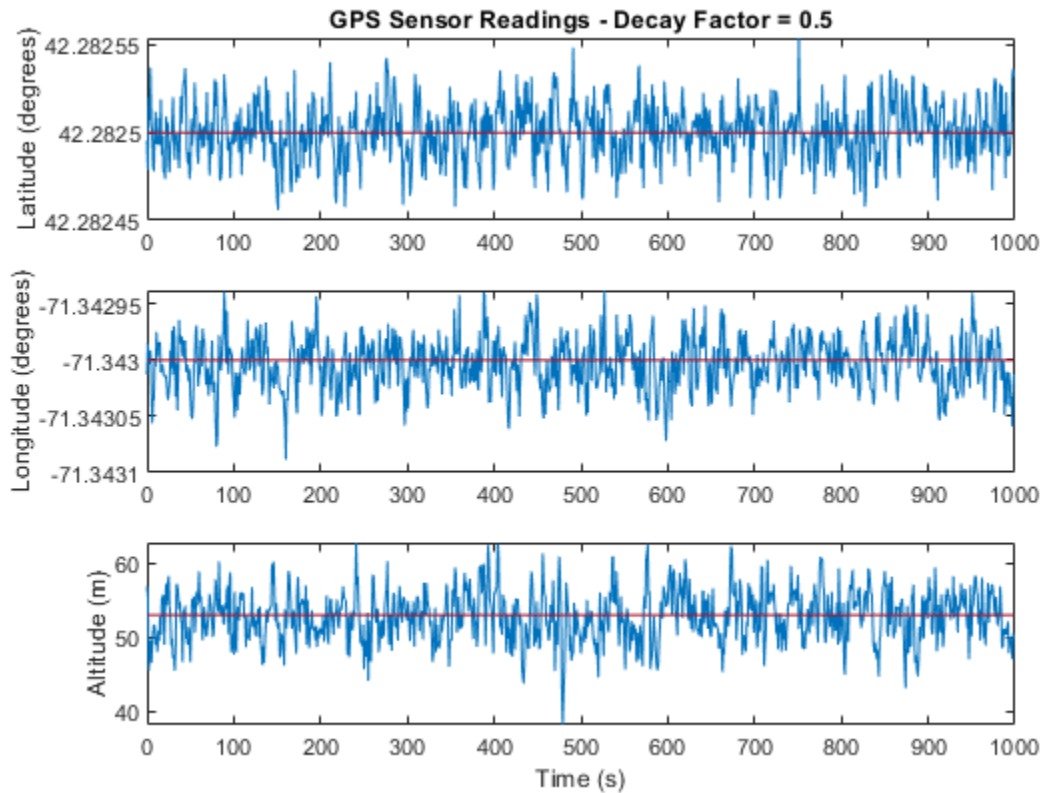

Relationship Between Groundspeed and Course Accuracy

GPS receivers achieve greater course accuracy as groundspeed increases. In this example, you create a GPS receiver simulation object and simulate the data received from a platform that is accelerating from a stationary position.

Create a default `gpsSensor` System object™ to model data returned by a GPS receiver.

```
GPS = gpsSensor
```

```
GPS =
  gpsSensor with properties:
```

```

          SampleRate: 1           Hz
    PositionInputFormat: 'Local'
      ReferenceLocation: [0 0 0]   [deg deg m]
HorizontalPositionAccuracy: 1.6   m
  VerticalPositionAccuracy: 3     m

```

```
VelocityAccuracy: 0.1           m/s
RandomStream: 'Global stream'
DecayFactor: 0.999
```

Create matrices to describe the position and velocity of a platform in the NED coordinate system. The platform begins from a stationary position and accelerates to 60 m/s North-East over 60 seconds, then has a vertical acceleration to 2 m/s over 2 seconds, followed by a 2 m/s rate of climb for another 8 seconds. Assume a constant velocity, such that the velocity is the simple derivative of the position.

```
duration = 70;
numSamples = duration*GPS.SampleRate;

course = 45*ones(duration,1);
groundspeed = [(1:60)';60*ones(10,1)];

Nvelocity = groundspeed.*sind(course);
Evelocity = groundspeed.*cosd(course);
Dvelocity = [zeros(60,1);-1;-2*ones(9,1)];
NEDvelocity = [Nvelocity,Evelocity,Dvelocity];

Ndistance = cumsum(Nvelocity);
Edistance = cumsum(Evelocity);
Ddistance = cumsum(Dvelocity);
NEDposition = [Ndistance,Edistance,Ddistance];
```

Model GPS measurement data by calling the GPS object with your velocity and position matrices.

```
[~,~,groundspeedMeasurement,courseMeasurement] = GPS(NEDposition,NEDvelocity);
```

Plot the groundspeed and the difference between the true course and the course returned by the GPS simulator.

As groundspeed increases, the accuracy of the course increases. Note that the velocity increase during the last ten seconds has no effect, because the additional velocity is not in the ground plane.

```
t = (0:numSamples-1)/GPS.SampleRate;

subplot(2,1,1)
plot(t,groundspeed);
ylabel('Speed (m/s)')
title('Relationship Between Groundspeed and Course Accuracy')

subplot(2,1,2)
courseAccuracy = courseMeasurement - course;
plot(t,courseAccuracy)
xlabel('Time (s)');
ylabel('Course Accuracy (degrees)')
```

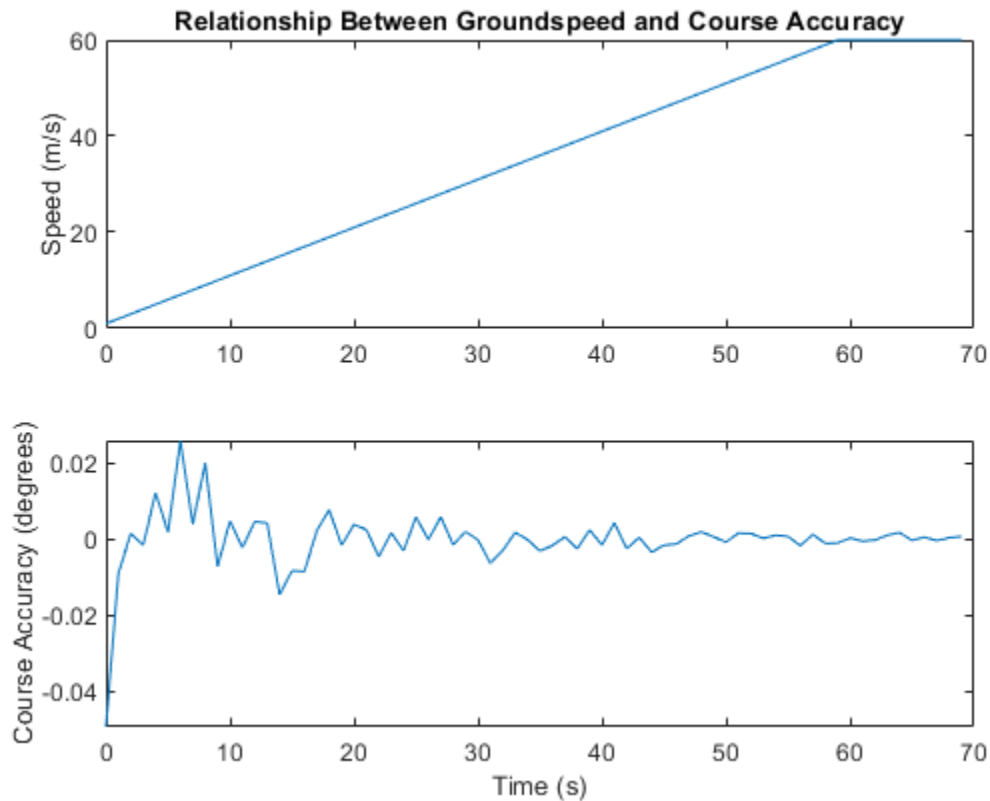

Model GPS Receiver Data

Simulate GPS data received during a trajectory from the city of Natick, MA, to Boston, MA.

Define the decimal degree latitude and longitude for the city of Natick, MA USA, and Boston, MA USA. For simplicity, set the altitude for both locations to zero.

```
NatickLLA = [42.27752809999999, -71.34680909999997, 0];
BostonLLA = [42.3600825, -71.05888010000001, 0];
```

Define a motion that can take a platform from Natick to Boston in 20 minutes. Set the origin of the local NED coordinate system as Natick. Create a `waypointTrajectory` object to output the trajectory 10 samples at a time.

```
fs = 1;
duration = 60*20;

bearing = 68; % degrees
distance = 25.39e3; % meters
distanceEast = distance*sind(bearing);
distanceNorth = distance*cosd(bearing);

NatickNED = [0,0,0];
BostonNED = [distanceNorth,distanceEast,0];
```

```
trajectory = waypointTrajectory( ...  
    'Waypoints', [NatickNED;BostonNED], ...  
    'TimeOfArrival',[0;duration], ...  
    'SamplesPerFrame',10, ...  
    'SampleRate',fs);
```

Create a `gpsSensor` object to model receiving GPS data for the platform. Set the `HorizontalPositionalAccuracy` to 25 and the `DecayFactor` to 0.25 to emphasize the noise. Set the `ReferenceLocation` to the Natick coordinates in LLA.

```
GPS = gpsSensor( ...  
    'HorizontalPositionalAccuracy',25, ...  
    'DecayFactor',0.25, ...  
    'SampleRate',fs, ...  
    'ReferenceLocation',NatickLLA);
```

Open a figure and plot the position of Natick and Boston in LLA. Ignore altitude for simplicity.

In a loop, call the `gpsSensor` object with the ground-truth trajectory to simulate the received GPS data. Plot the ground-truth trajectory and the model of received GPS data.

```
figure(1)  
plot(NatickLLA(1),NatickLLA(2),'ko', ...  
     BostonLLA(1),BostonLLA(2),'kx')  
xlabel('Latitude (degrees)')  
ylabel('Longitude (degrees)')  
title('GPS Sensor Data for Natick to Boston Trajectory')  
hold on  
  
while ~isDone(trajectory)  
    [truePositionNED,~,trueVelocityNED] = trajectory();  
    reportedPositionLLA = GPS(truePositionNED,trueVelocityNED);  
  
    figure(1)  
    plot(reportedPositionLLA(:,1),reportedPositionLLA(:,2),'r.')  
end
```

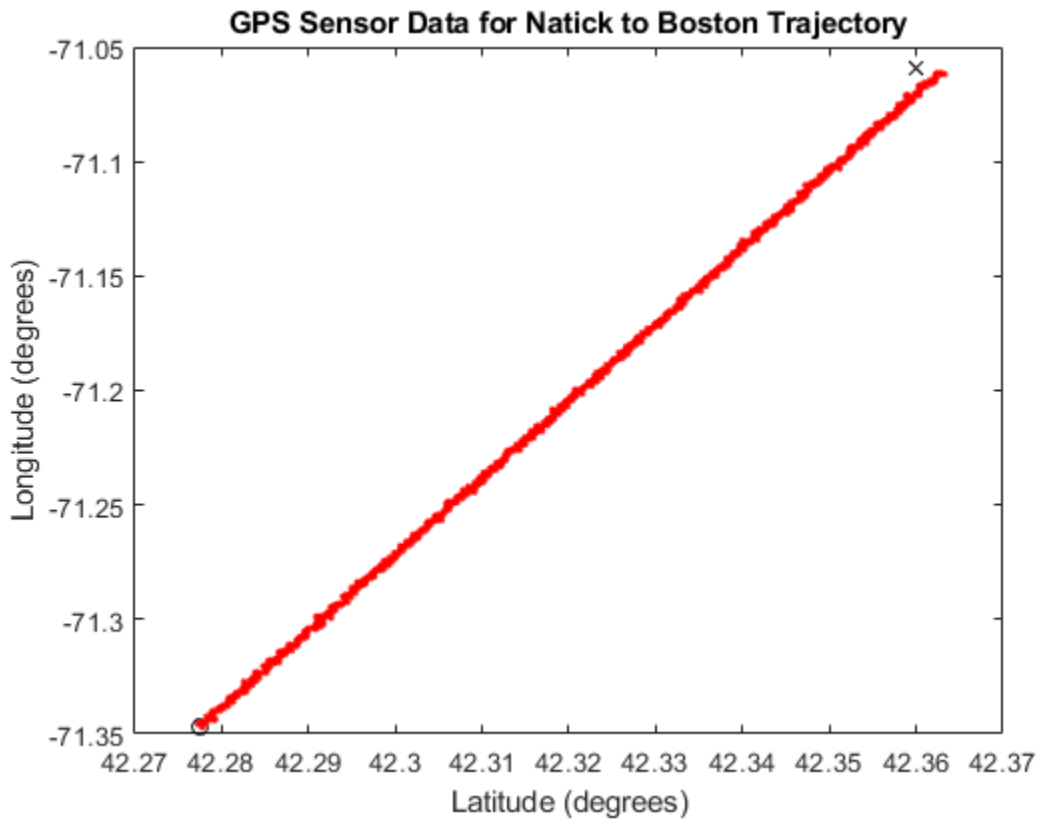
As a best practice, release System objects when complete.

```
release(GPS)
release(trajjectory)
```

Extended Capabilities

C/C++ Code Generation

Generate C and C++ code using MATLAB® Coder™.

Usage notes and limitations:

See “System Objects in MATLAB Code Generation” (MATLAB Coder).

See Also

Objects

imuSensor | insSensor

Topics

“Model IMU, GPS, and INS/GPS”

Introduced in R2018b

irSensor

Generate infrared detections for tracking scenario

Description

The `irSensor` System object creates a statistical model for generating detections using infrared sensors. You can use the `irSensor` object in a scenario that models moving and stationary platforms using `trackingScenario`. The sensor can simulate real detections with added random noise and also generate false alarm detections. In addition, you can use this object to create input to trackers such as `trackerGNN`, `trackerJPDA`, or `trackerTOMHT`.

This object enables you to configure a mechanically scanning sensor. An infrared scanning sensor changes the look angle between updates by stepping the mechanical position of the beam in increments of the angular span specified in the `FieldOfView` property. The infrared sensor scans the total region in azimuth and elevation defined by the `MechanicalScanLimits` property. If the scanning limits for azimuth or elevation are set to `[0 0]`, no scanning is performed along that dimension for that scan mode. Also, if the maximum scan rate for azimuth or elevation is set to zero, no scanning is performed along that dimension.

To generate infrared detections:

- 1 Create the `irSensor` object and set its properties.
- 2 Call the object with arguments, as if it were a function.

To learn more about how System objects work, see [What Are System Objects?](#).

Creation

Syntax

```
sensor = irSensor(SensorIndex)

sensor = irSensor(SensorIndex,'No scanning')
sensor = irSensor(SensorIndex,'Raster')
sensor = irSensor(SensorIndex,'Rotator')
sensor = irSensor(SensorIndex,'Sector')

sensor = irSensor( ___,Name,Value)
```

Description

`sensor = irSensor(SensorIndex)` creates an infrared detection generator object with a specified sensor index, `SensorIndex`, and default property values.

`sensor = irSensor(SensorIndex,'No scanning')` is a convenience syntax that creates an `irSensor` that stares along the sensor boresight direction. No mechanical scanning is performed. This syntax sets the `ScanMode` property to `'No scanning'`.

`sensor = irSensor(SensorIndex, 'Raster')` is a convenience syntax that creates an `irSensor` object that mechanically scans a raster pattern. The raster span is 90° in azimuth from -45° to +45° and in elevation from the horizon to 10° above the horizon. See “Convenience Syntaxes” on page 3-156 for the properties set by this syntax.

`sensor = irSensor(SensorIndex, 'Rotator')` is a convenience syntax that creates an `irSensor` object that mechanically scans 360° in azimuth by electronically rotating the sensor at a constant rate. When you set `HasElevation` to `true`, the infrared sensor mechanically points towards the center of the elevation field of view. See “Convenience Syntaxes” on page 3-156 for the properties set by this syntax.

`sensor = irSensor(SensorIndex, 'Sector')` is a convenience syntax to create an `irSensor` object that mechanically scans a 90° azimuth sector from -45° to +45°. Setting `HasElevation` to `true`, points the infrared sensor towards the center of the elevation field of view. Beams are stacked mechanically to process the entire elevation spanned by the scan limits in a single dwell. See “Convenience Syntaxes” on page 3-156 for the properties set by this syntax.

`sensor = irSensor(____, Name, Value)` sets properties using one or more name-value pairs after all other input arguments. Enclose each property name in quotes. For example, `irSensor(1, 'UpdateRate', 1, 'CutoffFrequency', 20e3)` creates an infrared sensor that reports detections at an update rate of 1 Hz and a cut off frequency of 20 kHz. If you specify the sensor index using the `SensorIndex` property, you can omit the `SensorIndex` input.

Properties

Unless otherwise indicated, properties are *nontunable*, which means you cannot change their values after calling the object. Objects lock when you call them, and the `release` function unlocks them.

If a property is *tunable*, you can change its value at any time.

For more information on changing property values, see System Design in MATLAB Using System Objects.

SensorIndex — Unique sensor identifier

positive integer

Unique sensor identifier, specified as a positive integer. This property distinguishes detections that come from different sensors in a multi-sensor system. When creating an `irSensor` system object, you must either specify the `SensorIndex` as the first input argument in the creation syntax, or specify it as the value for the `SensorIndex` property in the creation syntax.

Example: 2

Data Types: `double`

UpdateRate — Sensor update rate

1 (default) | positive scalar

Sensor update rate, specified as a positive scalar. This interval must be an integer multiple of the simulation time interval defined by `trackingScenario`. The `trackingScenario` object calls the infrared sensor at simulation time intervals. The sensor generates new detections at intervals defined by the reciprocal of the `UpdateRate` property. Any update requested to the sensor between update intervals contains no detections. Units are in hertz.

Example: 5

Data Types: double

ScanMode — Scanning mode of infrared sensor

'Mechanical' (default) | 'No scanning'

Scanning mode of infrared sensor, specified as 'Mechanical' or 'No scanning'. When set to 'Mechanical', the sensor scans mechanically across the azimuth and elevation limits specified by the `MechanicalScanLimits` property. The scan positions step by the sensor's field of view between dwells. When set to 'No scanning', no scanning is performed by the sensor.

Example: 'No scanning'

Data Types: char

MountingLocation — Sensor location on platform

[0 0 0] (default) | 1-by-3 real-valued vector

Sensor location on platform, specified as a 1-by-3 real-valued vector. This property defines the coordinates of the sensor with respect to the platform origin. The default value specifies that the sensor origin is at the origin of its platform. Units are in meters.

Example: [.2 0.1 0]

Data Types: double

MountingAngles — Orientation of sensor

[0 0 0] (default) | 3-element real-valued vector

Orientation of the sensor with respect to the platform, specified as a three-element real-valued vector. Each element of the vector corresponds to an intrinsic Euler angle rotation that carries the body axes of the platform to the sensor axes. The three elements describes the rotations around the *z*-, *y*-, and *x*-axes sequentially. Units are in degrees.

Example: [10 20 -15]

Data Types: double

FieldOfView — Fields of view of sensor

[1;5] | real-valued 2-by-1 vector of positive real-values

This property is read-only.

Fields of view of sensor, specified as a 2-by-1 vector of positive real values, [azfov;elfov]. The field of view defines the total angular extent spanned by the sensor. Each component must lie in the interval (0,180]. Targets outside of the field of view of the sensor will not be detected. Units are in degrees.

Example: [14;70]

Data Types: double

MaxMechanicalScanRate — Maximum mechanical scan rate

[75;75] (default) | nonnegative scalar | real-valued 2-by-1 vector with nonnegative entries

Maximum mechanical scan rate, specified as a nonnegative scalar or real-valued 2-by-1 vector with nonnegative entries.

When `HasElevation` is `true`, specify the scan rate as a 2-by-1 column vector of nonnegative entries [maxAzRate; maxElRate]. `maxAzRate` is the maximum scan rate in azimuth and `maxElRate` is the maximum scan rate in elevation.

When `HasElevation` is `false`, specify the scan rate as a nonnegative scalar representing the maximum mechanical azimuth scan rate.

Scan rates set the maximum rate at which the infrared sensor can mechanically scan. The sensor sets its scan rate to step the mechanical angle by the field of regard. If the required scan rate exceeds the maximum scan rate, the maximum scan rate is used. Units are degrees per second.

Example: `[5;10]`

Dependencies

To enable this property, set the `ScanMode` property to 'Mechanical'.

Data Types: `double`

MechanicalScanLimits — Angular limits of mechanical scan directions of sensor

`[0 360;-10 0]` (default) | real-valued, 1-by-2 row vector | real-valued 2-by-2 matrix

Angular limits of mechanical scan directions of sensor, specified as a real-valued, 1-by-2 row vector or a real-valued 2-by-2 matrix. The mechanical scan limits define the minimum and maximum mechanical angles the sensor can scan from its mounted orientation.

When `HasElevation` is `true`, the scan limits take the form `[minAz maxAz; minEl maxEl]`. `minAz` and `maxAz` represent the minimum and maximum limits of the azimuth angle scan. `minEl` and `maxEl` represent the minimum and maximum limits of the elevation angle scan. When `HasElevation` is `false`, the scan limits take the form `[minAz maxAz]`. If you specify the scan limits as a 2-by-2 matrix but set `HasElevation` to `false`, the second row of the matrix is ignored.

Azimuthal scan limits cannot span more than 360° and elevation scan limits must lie within the closed interval `[-90° 90°]`. Units are in degrees.

Example: `[10 90;0 85]`

Dependencies

To enable this property, set the `ScanMode` property to 'Mechanical'.

Data Types: `double`

MechanicalAngle — Current mechanical scan angle

scalar | real-valued 2-by-1 vector

This property is read-only.

Current mechanical scan angle, returned as a scalar or real-valued 2-by-1 vector. When `HasElevation` is `true`, the scan angle takes the form `[Az; El]`. `Az` and `El` represent the azimuth and elevation scan angles, respectively, relative to the mounted angle of the sensor on the platform. When `HasElevation` is `false`, the scan angle is a scalar representing the azimuth scan angle.

Data Types: `double`

LookAngle — Look angle of sensor

scalar | real-valued 2-by-1 vector

This property is read-only.

Look angle of sensor, specified as a scalar or real-valued 2-by-1 vector. Look angle depends on the mechanical angle set in the `ScanMode` property.

ScanMode	LookAngle
'Mechanical'	MechanicalAngle
'No scanning'	0

When HasElevation is true, the look angle takes the form [Az;El]. Az and El represent the azimuth and elevation look angles, respectively. When HasElevation is false, the look angle is a scalar representing the azimuth look angle.

LensDiameter — Lens diameter

8.0e-2 (default) | positive scalar

Lens diameter, specified as a positive scalar. Units are in meters.

Example: 0.1

Data Types: double

FocalLength — Focal length of sensor circular lens

800 (default) | scalar

Focal length of sensor circular lens, specified as a scalar. The focal length in pixels is $f = F s$, where F is the focal length in millimeters and s is the number of pixels per millimeter.

Example: 500

Data Types: double

NumDetectors — Number of infrared detectors in sensor imaging plane

[1000 1000] | positive, real-valued, two-element vector

Number of infrared detectors in the sensor imaging plane, specified as a positive, real-valued, two-element row vector. The first element defines the number of rows in the imaging plane and the second element defines the number of columns in the imaging plane. The number of rows corresponds to the sensor elevation resolution and the number of columns corresponds to the sensor azimuth resolution.

Example: [500 750]

Data Types: double

CutoffFrequency — Cut off frequency of sensor modulation transfer function

20e3 | positive scalar

Cut off frequency of the sensor modulation transfer function (MTF), specified as a positive scalar. Units are in hertz.

Example: 30.5e3

Dependencies

To enable this property, set the ScanMode property to 'Mechanical'.

Data Types: double

DetectorArea — Area of infrared detector element

1.44e-6 | positive scalar

Area of an infrared detector element/pixel, specified as a positive scalar. Units are in square-meters.

Example: 3.0e-5

Data Types: double

Detectivity — Specific detectivity of detector material

1.2e10 | positive scalar

Specific detectivity of the detector material, specified as a positive scalar. Units are cm-sqrt(Hz)/W.

Example: .9e10

Data Types: double

NoiseEquivalentBandwidth — Noise equivalent bandwidth of sensor

30 (default) | positive scalar

Noise equivalent bandwidth of sensor, specified as a positive scalar. Units are in Hz.

Example: 100

Data Types: double

FalseAlarmRate — False alarm rate

1e-6 (default) | positive scalar

Rate of false alarm report in each resolution cell, specified as a positive scalar in the range of $[10^{-7}, 10^{-3}]$. Units are dimensionless. Resolution cells are determined from the AzimuthResolution property and the optionally enabled ElevationResolution property.

Example: 1e-5

Data Types: double

AzimuthResolution — Azimuth resolution

1 (default) | positive scalar

This property is read-only.

Azimuth resolution of the sensor, specified as a positive scalar. The azimuth resolution defines the minimum separation in azimuth angle at which the sensor can distinguish two targets. The azimuth resolution is derived from the focal length of the lens and the number of columns in the detector's imaging plane. Units are in degrees.

Data Types: double

ElevationResolution — Elevation resolution of sensor

1 (default) | positive scalar

This property is read-only.

Elevation resolution of the sensor, specified as a positive scalar. The elevation resolution defines the minimum separation in elevation angle at which the sensor can distinguish two targets. The elevation resolution is derived from the focal length of the lens and the number of rows in the detector's imaging plane. Units are in degrees.

Dependencies

To enable this property, set the HasElevation property to true.

Data Types: double

AzimuthBiasFraction — Azimuth bias fraction`0.1 (default) | nonnegative scalar`

Azimuth bias fraction of the sensor, specified as a nonnegative scalar. The azimuth bias is expressed as a fraction of the azimuth resolution specified in `AzimuthResolution`. This value sets a lower bound on the azimuthal accuracy of the sensor. This property only applies for modes where the sensor is scanning. The value is dimensionless.

Data Types: `double`

ElevationBiasFraction — Elevation bias fraction`0.1 (default) | nonnegative scalar`

Elevation bias fraction of the sensor, specified as a nonnegative scalar. Elevation bias is expressed as a fraction of the elevation resolution specified by the value of the `ElevationResolution` property. This value sets a lower bound on the elevation accuracy of the sensor. This property only applies for modes where the sensor is scanning. The value is dimensionless.

Dependencies

To enable this property, set the `HasElevation` property to `true`.

Data Types: `double`

HasElevation — Enable sensor elevation scan and measurements`false (default) | true`

Enable the sensor to measure target elevation angles and to scan in elevation, specified as `false` or `true`. Set this property to `true` to model an infrared sensor that can estimate target elevation and scan in elevation.

Data Types: `logical`

HasAngularSize — Enable angular size measurements`false (default) | true`

Enable the sensor to return the azimuth and elevation size or span of the target in the reported detections, specified as `false` or `true`. If this property is set to `false`, then the only azimuth and elevation locations instead of their angular extent are reported in the detections.

Data Types: `logical`

HasINS — Enable inertial navigation system (INS) input`false (default) | true`

Enable the optional input argument that passes the current estimate of the sensor platform pose to the sensor, specified as `false` or `true`. When `true`, pose information is added to the `MeasurementParameters` structure of the reported detections. Pose information lets tracking and fusion algorithms estimate the state of the target detections in the north-east-down (NED) frame.

Data Types: `logical`

HasNoise — Enable addition of noise to sensor measurements`true (default) | false`

Enable addition of noise to sensor measurements, specified as `true` or `false`. Set this property to `true` to add noise to the measurements. Otherwise, the measurements have no noise. Note that the

reported measurement noise covariance is not dependent on this property and is always representative of the noise that will be added when `HasNoise` is set to `true`.

Data Types: `logical`

HasFalseAlarms — Enable creating false alarm sensor detections

`true` (default) | `false`

Enable creating false alarm sensor measurements, specified as `true` or `false`. Set this property to `true` to report false alarms. Otherwise, only actual detections are reported.

Data Types: `logical`

HasOcclusion — Enable occlusion from extended objects

`true` (default) | `false`

Enable occlusion from extended objects, specified as `true` or `false`. Set this property to `true` to model occlusion from extended objects. Two types of occlusion (self occlusion and inter object occlusion) are modeled. Self occlusion occurs when one side of an extended object occludes another side. Inter object occlusion occurs when one extended object stands in the line of sight of another extended object or a point target. Note that both extended objects and point targets can be occluded by extended objects, but a point target cannot occlude another point target or an extended object.

Set this property to `false` to disable occlusion of extended objects. This will also disable the merging of objects whose detections share a common sensor resolution cell, which gives each object in the tracking scenario an opportunity to generate a detection.

Data Types: `logical`

MinClassificationArea — Minimum image size for classification

100 (default) | positive integer

Minimum image size for classification, specified as a positive integer. `MinClassificationArea` specifies the minimum area (in square pixels) used to decide whether the sensor recognizes the detection as a classified object. The `irSensor` tries to enclose the extent detection using a minimum rectangular bounding box (along the azimuth and elevation directions) in the sensor image plane. If the area of the minimum bounding box is less than the value given by the `MinClassificationArea` property, then the reported `ClassID` is zero in the returned `objectDetection` for that detection. Otherwise, the reported `ClassID` is obtained from the `ClassID` of the corresponding target input.

Data Types: `double`

MaxAllowedOcclusion — Maximum allowed occlusion

0.5 (default) | real scalar in [0,1)

Maximum allowed occlusion, specified as a real scalar on the interval of [0,1). The property specifies the ratio of the occluded area relative to the total area of a target's bounding box. If the occluded area ratio is larger than the value specified by the `MaxAllowedOcclusion` property, the occluded target will not be detected.

Data Types: `double`

MaxNumDetectionsSource — Source of maximum number of detections to be reported

'Auto' (default) | 'Property'

Source of maximum number of detections reported by the sensor, specified as 'Auto' or 'Property'. When this property is set to 'Auto', the sensor reports all detections. When this

property is set to 'Property', the sensor reports detections up to the number specified by the `MaxNumDetections` property.

Data Types: `char`

MaxNumDetections – Maximum number of reported detections

50 (default) | positive integer

Maximum number of detections can be reported by the sensor, specified as a positive integer. Detections are reported in order of distance to the sensor until the maximum number is reached.

Dependencies

To enable this property, set the `MaxNumDetectionsSource` property to 'Property'.

Data Types: `double`

Usage

Syntax

```
dets = sensor(targets,simTime)
dets = sensor(targets,ins,simTime)
[dets,numDets,config] = sensor( __ )
```

Description

`dets = sensor(targets,simTime)` creates infrared detections, `dets`, from sensor measurements taken of `targets` at the current simulation time, `simTime`. The sensor can generate detections for multiple targets simultaneously.

`dets = sensor(targets,ins,simTime)` also specifies the INS estimated pose information, `ins`, for the sensor platform. INS information is used by tracking and fusion algorithms to estimate the target positions in the NED frame.

To enable this syntax, set the `HasINS` property to `true`.

`[dets,numDets,config] = sensor(__)` also returns the number of valid detections reported, `numValidDets`, and the configuration of the sensor, `config`, at the current simulation time.

Input Arguments

targets – Tracking scenario target poses

structure | structure array

Tracking scenario target poses, specified as a structure or array of structures. Each structure corresponds to a target. You can generate this structure using the `targetPoses` method of a platform. You can also create such a structure manually. The table shows the required fields of the structure:

Field	Description
PlatformID	Unique identifier for the platform, specified as a positive integer. This is a required field with no default value.

Field	Description
ClassID	User-defined integer used to classify the type of target, specified as a nonnegative integer. 0 is reserved for unclassified platform types and is the default value.
Position	Position of target in platform coordinates, specified as a real-valued, 1-by-3 vector. This is a required field with no default value. Units are in meters.
Velocity	Velocity of target in platform coordinates, specified as a real-valued, 1-by-3 vector. Units are in meters per second. The default is [0 0 0].
Acceleration	Acceleration of target in platform coordinates, specified as a 1-by-3 row vector. Units are in meters per second-squared. The default is [0 0 0].
Orientation	Orientation of the target with respect to platform coordinates, specified as a scalar quaternion or a 3-by-3 rotation matrix. Orientation defines the frame rotation from the platform coordinate system to the current target body coordinate system. Units are dimensionless. The default is quaternion(1,0,0,0).
AngularVelocity	Angular velocity of the target in platform coordinates, specified as a real-valued, 1-by-3 vector. The magnitude of the vector defines the angular speed. The direction defines the axis of clockwise rotation. Units are in degrees per second. The default is [0 0 0].

The values of the `Position`, `Velocity`, and `Orientation` fields are defined with respect to the platform coordinate system.

simTime – Current simulation time

nonnegative scalar

Current simulation time, specified as a positive scalar. The `trackingScenario` object calls the infrared sensor at regular time intervals. The sensor generates new detections at intervals defined by the `UpdateInterval` property. The value of the `UpdateInterval` property must be an integer multiple of the simulation time interval. Updates requested from the sensor between update intervals contain no detections. Units are in seconds.

Example: 10.5

Data Types: `double`

ins – Platform pose from INS

structure

Sensor platform pose obtained from the inertial navigation system (INS), specified as a structure.

Platform pose information from an inertial navigation system (INS) is a structure with these fields:

Field	Definition
Position	Position in the navigation frame, specified as a real-valued 1-by-3 vector. Units are in meters.
Velocity	Velocity in the navigation frame, specified as a real-valued 1-by-3 vector. Units are in meters per second.
Orientation	Orientation with respect to the navigation frame, specified as a quaternion or a 3-by-3 real-valued rotation matrix. The rotation is from the navigation frame to the current INS body frame. This is also referred to as a "parent to child" rotation.

Dependencies

To enable this argument, set the HasINS property to true.

Data Types: struct

interference — Interfering or jamming signal

structure

Interfering or jamming signal, specified as a structure.

Dependencies

To enable this argument, set the HasInterference property to true.

Data Types: double

Complex Number Support: Yes

Output Arguments

dets — sensor detections

cell array of objectDetection objects

Sensor detections, returned as a cell array of objectDetection objects. Each object has these properties:

Property	Definition
Time	Measurement time
Measurement	Object measurements
MeasurementNoise	Measurement noise covariance matrix
SensorIndex	Unique ID of the sensor
ObjectClassID	Object classification
ObjectAttributes	Additional information passed to tracker
MeasurementParameters	Parameters used by initialization functions of nonlinear Kalman tracking filters

Measurement and MeasurementNoise are reported in the sensor spherical coordinate frame.

numDets — Number of detections

nonnegative integer

Number of detections reported, returned as a nonnegative integer.

- When the `MaxNumDetectionsSource` property is set to 'Auto', `numDets` is set to the length of `dets`.
- When the `MaxNumDetectionsSource` property is set to 'Property', `dets` is a cell array with length determined by the `MaxNumDetections` property. No more than `MaxNumDetections` number of detections are returned. If the number of detections is fewer than `MaxNumDetections`, the first `numDets` elements of `dets` hold valid detections. The remaining elements of `dets` are set to the default value.

Data Types: `double`**config — Current sensor configuration**

structure

Current sensor configuration, specified as a structure. This output can be used to determine which objects fall within the sensor beam during object execution.

Field	Description
<code>SensorIndex</code>	Unique sensor index, returned as a positive integer.
<code>IsValidTime</code>	Valid detection time, returned as <code>true</code> or <code>false</code> . <code>IsValidTime</code> is <code>false</code> when detection updates are requested between update intervals specified by the update rate.
<code>IsScanDone</code>	<code>IsScanDone</code> is <code>true</code> when the sensor has completed a scan.
<code>FieldOfView</code>	Field of view of the sensor, returned as a 2-by-1 vector of positive real values, <code>[azfov;elfov]</code> . <code>azfov</code> and <code>elfov</code> represent the field of view in azimuth and elevation, respectively.
<code>MeasurementParameters</code>	Sensor measurement parameters, returned as an array of structures containing the coordinate frame transforms needed to transform positions and velocities in the top-level frame to the current sensor frame.

Data Types: `struct`**Object Functions**

To use an object function, specify the `System` object as the first input argument. For example, to release system resources of a `System` object named `obj`, use this syntax:

```
release(obj)
```

Specific to `irSensor`

`coverageConfig` Sensor and emitter coverage configuration
`perturbations` Perturbation defined on object
`perturb` Apply perturbations to object

Common to All System Objects

`step` Run System object algorithm
`release` Release resources and allow changes to System object property values and input characteristics
`reset` Reset internal states of System object

Examples

Detection Using Infrared Sensor

Detect a target with an infrared sensor.

First create a target structure.

```
tgt = struct( ...  
    'PlatformID',1, ...  
    'Position',[10e3 0 0], ...  
    'Speed',900*1e3/3600);
```

Then create an IR sensor.

```
sensor = irSensor(1);
```

Generate detection from target.

```
time = 0;  
[dets,numDets,config] = sensor(tgt,time)
```

```
dets = 1x1 cell array  
      {1x1 objectDetection}
```

```
numDets = 1
```

```
config = struct with fields:  
    SensorIndex: 1  
    IsValidTime: 1  
    IsScanDone: 0  
    FieldOfView: [64.0108 64.0108]  
    MeasurementParameters: [1x1 struct]
```

More About

Convenience Syntaxes

The convenience syntaxes set several properties together to model a specific type of infrared sensor.

No Scanning

Sets ScanMode to 'No scanning'.

Raster Scanning

This syntax sets these properties:

Property	Value
ScanMode	'Mechanical'
HasElevation	true
MaxMechanicalScanRate	[75;75]
MechanicalScanLimits	[-45 45; -10 0]
ElectronicScanLimits	[-45 45; -10 0]

Rotator Scanning

This syntax sets these properties:

Property	Value
ScanMode	'Mechanical'
FieldOfView	[1:10]
HasElevation	false or true
MechanicalScanLimits	[0 360; -10 0]
ElevationResolution	10/sqrt(12)

Sector Scanning

This syntax sets these properties:

Property	Value
ScanMode	'Mechanical'
FieldOfView	[1;10]
HasElevation	false
MechanicalScanLimits	[-45 45; -10 0]
ElectronicScanLimits	[-45 45; -10 0]
ElevationResolution	10/sqrt(12)

Extended Capabilities**C/C++ Code Generation**

Generate C and C++ code using MATLAB® Coder™.

Usage notes and limitations:

See “System Objects in MATLAB Code Generation” (MATLAB Coder).

See Also

Objects

objectDetection | trackerGNN | trackerTOMHT

Functions

targetPoses

Introduced in R2018b

sonarSensor

Generate detections from sonar emissions

Description

The `sonarSensor` System object creates a statistical model for generating detections from sonar emissions. You can generate detections from active or passive sonar systems. You can use the `sonarSensor` object in a scenario that models moving and stationary platforms using `trackingScenario`. The sonar sensor can simulate real detections with added random noise and also generate false alarm detections. In addition, you can use this object to create input to trackers such as `trackerGNN` or `trackerTOMHT`.

This object enables you to configure an electronically scanning sonar. A scanning sonar changes the look angle between updates by stepping the electronic position of the beam in increments of the angular span specified in the `FieldOfView` property. The sonar scans the total region in azimuth and elevation defined by the sonar electronic scan limits, `ElectronicScanLimits`. If the scanning limits for azimuth or elevation are set to `[0 0]`, no scanning is performed along that dimension for that scan mode. If the maximum electronic scan rate for azimuth or elevation is set to zero, no electronic scanning is performed along that dimension.

To generate sonar detections:

- 1 Create the `sonarSensor` object and set its properties.
- 2 Call the object with arguments, as if it were a function.

To learn more about how System objects work, see [What Are System Objects?](#).

Creation

Syntax

```
sensor = sonarSensor(SensorIndex)
```

```
sensor = sonarSensor(SensorIndex, 'No scanning')
```

```
sensor = sonarSensor(SensorIndex, 'Raster')
```

```
sensor = sonarSensor(SensorIndex, 'Rotator')
```

```
sensor = sonarSensor(SensorIndex, 'Sector')
```

```
sensor = sonarSensor( ___, Name, Value)
```

Description

`sensor = sonarSensor(SensorIndex)` creates a sonar detection generator object with default property values.

`sensor = sonarSensor(SensorIndex, 'No scanning')` is a convenience syntax that creates a `sonarSensor` that stares along the sonar transducer boresight direction. No electronic scanning is performed. This syntax sets the `ScanMode` property to `'No scanning'`.

`sensor = sonarSensor(SensorIndex, 'Raster')` is a convenience syntax that creates a `sonarSensor` object that electronically scans a raster pattern. The raster span is 90° in azimuth from -45° to +45° and in elevation from the horizon to 10° above the horizon. See “Convenience Syntaxes” on page 3-177 for the properties set by this syntax.

`sensor = sonarSensor(SensorIndex, 'Rotator')` is a convenience syntax that creates a `sonarSensor` object that electronically scans 360° in azimuth by electronically rotating the transducer at a constant rate. When you set `HasElevation` to `true`, the sonar transducer electronically points towards the center of the elevation field of view. See “Convenience Syntaxes” on page 3-177 for the properties set by this syntax.

`sensor = sonarSensor(SensorIndex, 'Sector')` is a convenience syntax to create a `sonarSensor` object that electronically scans a 90° azimuth sector from -45° to +45°. Setting `HasElevation` to `true`, points the sonar transducer towards the center of the elevation field of view. Beams are stacked electronically to process the entire elevation spanned by the scan limits in a single dwell. See “Convenience Syntaxes” on page 3-177 for the properties set by this syntax.

`sensor = sonarSensor(____, Name, Value)` sets properties using one or more name-value pairs after all other input arguments. Enclose each property name in quotes. For example, `sonarSensor('DetectionCoordinates', 'Sensor cartesian', 'MaxRange', 200)` creates a sonar detection generator that reports detections in the sensor Cartesian coordinate system and has a maximum detection range of 200 meters. If you specify the sensor index using the `SensorIndex` property, you can omit the `SensorIndex` input.

Properties

Unless otherwise indicated, properties are *nontunable*, which means you cannot change their values after calling the object. Objects lock when you call them, and the `release` function unlocks them.

If a property is *tunable*, you can change its value at any time.

For more information on changing property values, see System Design in MATLAB Using System Objects.

SensorIndex — Unique sensor identifier

positive integer

Unique sensor identifier, specified as a positive integer. This property distinguishes detections that come from different sensors in a multi-sensor system. When creating a `sonarSensor` system object, you must either specify the `SensorIndex` as the first input argument in the creation syntax, or specify it the value for the `SensorIndex` property in the creation syntax.

Example: 2

Data Types: `double`

UpdateRate — Sensor update rate

1 (default) | positive scalar

Sensor update rate, specified as a positive scalar. This interval must be an integer multiple of the simulation time interval defined by `trackingScenario`. The `trackingScenario` object calls the sonar sensor at simulation time intervals. The sonar generates new detections at intervals defined by the reciprocal of the `UpdateRate` property. Any update requested to the sensor between update intervals contains no detections. Units are in hertz.

Example: 5

Data Types: double

DetectionMode — Detection mode

'passive' (default) | 'monostatic'

Detection mode, specified as 'passive' or 'monostatic'. When set to 'passive', the sensor operates passively. When set to 'monostatic', the sensor generates detections from reflected signals originating from a collocated sonar emitter.

Example: 'Monostatic'

Data Types: char | string

EmitterIndex — Unique monostatic emitter index

positive integer

Unique monostatic emitter index, specified as a positive integer. The emitter index identifies the monostatic sonar emitter providing the reference signal to the sensor.

Example: 404

Dependencies

Set this property when the DetectionMode property is set to 'monostatic'.

Data Types: double

MountingLocation — Sensor location on platform

[0 0 0] (default) | 1-by-3 real-valued vector

Sensor location on platform, specified as a 1-by-3 real-valued vector. This property defines the coordinates of the sensor with respect to the platform origin. The default value specifies that the sensor origin is at the origin of its platform. Units are in meters.

Example: [.2 0.1 0]

Data Types: double

MountingAngles — Orientation of sensor

[0 0 0] (default) | 3-element real-valued vector

Orientation of the sensor with respect to the platform, specified as a three-element real-valued vector. Each element of the vector corresponds to an intrinsic Euler angle rotation that carries the body axes of the platform to the sensor axes. The three elements define the rotations around the z-, y-, and x-axes, in that order. The first rotation rotates the platform axes around the z-axis. The second rotation rotates the carried frame around the rotated y-axis. The final rotation rotates the frame around the carried x-axis. Units are in degrees.

Example: [10 20 -15]

Data Types: double

FieldOfView — Fields of view of sensor

[10;50] | 2-by-1 vector of positive scalar

Fields of view of sensor, specified as a 2-by-1 vector of positive scalars in degree, [azfov;elfov]. The field of view defines the total angular extent spanned by the sensor. The azimuth filed of view

azfov must lie in the interval (0,360]. The elevation field of view elfov must lie in the interval (0,180].

Example: [14;7]

Data Types: double

ScanMode — Scanning mode of sonar

'Electronic' (default) | 'No scanning'

Scanning mode of sonar, specified as 'Electronic' or 'No scanning'.

Scan Modes

ScanMode	Purpose
'Electronic'	The sonar scans electronically across the azimuth and elevation limits specified by the <code>ElectronicScanLimits</code> property. The scan direction increments by the sonar field of view angle between dwells.
'No scanning'	The sonar beam points along the transducer boresight defined by the <code>mountingAngles</code> property.

Example: 'No scanning'

Data Types: char

MechanicalAngle — Current mechanical scan angle

scalar | real-valued 2-by-1 vector

This property is read-only.

Current mechanical scan angle of sonar, returned as a scalar or real-valued 2-by-1 vector. When `HasElevation` is `true`, the scan angle takes the form [Az; El]. Az and El represent the azimuth and elevation scan angles, respectively, relative to the mounted angle of the sonar on the platform. When `HasElevation` is `false`, the scan angle is a scalar representing the azimuth scan angle.

Data Types: double

ElectronicScanLimits — Angular limits of electronic scan directions of sonar

[-45 45; -45 45] (default) | real-valued 1-by-2 row vector | real-valued 2-by-2 matrix

Angular limits of electronic scan directions of sonar, specified as a real-valued, 1-by-2 row vector or a real-valued 2-by-2 matrix. The electronic scan limits define the minimum and maximum electronic angles the sonar can scan from its current mechanical direction.

When `HasElevation` is `true`, the scan limits take the form [minAz maxAz; minEl maxEl]. minAz and maxAz represent the minimum and maximum limits of the azimuth angle scan. minEl and maxEl represent the minimum and maximum limits of the elevation angle scan. When `HasElevation` is `false`, the scan limits take the form [minAz maxAz]. If you specify the scan limits as a 2-by-2 matrix but set `HasElevation` to `false`, the second row of the matrix is ignored.

Azimuthal scan limits and elevation scan limits must lie within the closed interval [-90° 90°]. Units are in degrees.

Example: [-90 90;0 85]

Dependencies

To enable this property, set the ScanMode property to 'Electronic'.

Data Types: double

ElectronicAngle — Current electronic scan angle

electronic scalar | nonnegative scalar

This property is read-only.

Current electronic scan angle of sonar, returned as a scalar or 1-by-2 column vector. When HasElevation is true, the scan angle takes the form [Az;El]. Az and El represent the azimuth and elevation scan angles, respectively. When HasElevation is false, the scan angle is a scalar representing the azimuth scan angle.

Dependencies

To enable this property, set the ScanMode property to 'Electronic'.

Data Types: double

LookAngle — Look angle of sensor

scalar | real-valued 2-by-1 vector

This property is read-only.

Look angle of sensor, specified as a scalar or real-valued 2-by-1 vector. Look angle depends on the electronic angle set in the ScanMode property.

ScanMode	LookAngle
'Electronic'	ElectronicAngle
'No scanning'	0

When HasElevation is true, the look angle takes the form [Az;El]. Az and El represent the azimuth and elevation look angles, respectively. When HasElevation is false, the look angle is a scalar representing the azimuth look angle.

HasElevation — Enable sonar elevation scan and measurements

false (default) | true

Enable the sonar to measure target elevation angles and to scan in elevation, specified as false or true. Set this property to true to model a sonar sensor that can estimate target elevation and scan in elevation.

Data Types: logical

CenterFrequency — Center frequency of sonar band

20e3 (default) | positive scalar

Center frequency of sonar band, specified as a positive scalar. Units are in hertz.

Example: 25.5e3

Data Types: double

Bandwidth — Sonar waveform bandwidth

2e3 | positive scalar

Sonar waveform bandwidth, specified as a positive scalar. Units are in hertz.

Example: 1.5e3

Data Types: double

WaveformTypes — Types of detected waveforms0 (default) | nonnegative integer-valued L -element vectorTypes of detected waveforms, specified as a nonnegative integer-valued L -element vector.

Example: [1 4 5]

Data Types: double

ConfusionMatrix — Probability of correct classification of detected waveform1 (default) | positive scalar | real-valued nonnegative L -element vector | real-valued nonnegative L -by- L matrix

Probability of correct classification of a detected waveform, specified as a positive scalar, a real-valued nonnegative L -element vector, or a real-valued nonnegative L -by- L matrix. Matrix values range from 0 through 1 and matrix rows must sum to 1. L is the number of waveform types that the sensor can detect, as indicated by the value set in the `WaveformTypes` property. The (i,j) matrix element represents the probability of classifying the i^{th} waveform as the j^{th} waveform. When specified as a scalar from 0 through 1, the value is expanded along the diagonal of the confusion matrix. When specified as a vector, it must have the same number of elements as the `WaveformTypes` property. When defined as a scalar or a vector, the off diagonal values are set to $(1-\text{val})/(L-1)$.

Data Types: double

AmbientNoiseLevel — Spectrum-level ambient isotropic noise

70 (default) | scalar

Spectrum-level ambient isotropic noise, specified as a scalar. Units are in dB relative to the intensity of a plane wave with 1 μPa rms pressure in a 1-hertz frequency band.

Example: 25

Data Types: double

FalseAlarmRate — False alarm rate

1e-6 (default) | positive scalar

False alarm report rate within each resolution cell, specified as a positive scalar in the range $[10^{-7}, 10^{-3}]$. Units are dimensionless. Resolution cells are determined from the `AzimuthResolution` property and the `ElevationResolution` property when enabled.

Example: 1e-5

Data Types: double

AzimuthResolution — Azimuth resolution of sonar

1 (default) | positive scalar

Azimuth resolution of the sonar, specified as a positive scalar. The azimuth resolution defines the minimum separation in azimuth angle at which the sonar can distinguish two targets. The azimuth

resolution is typically the 3-dB downpoint of the azimuth angle beamwidth of the sonar. Units are in degrees.

Data Types: `double`

ElevationResolution — Elevation resolution of sonar

1 (default) | positive scalar

Elevation resolution of the sonar, specified as a positive scalar. The elevation resolution defines the minimum separation in elevation angle at which the sonar can distinguish two targets. The elevation resolution is typically the 3-dB downpoint in the elevation angle beamwidth of the sonar. Units are in degrees.

Dependencies

To enable this property, set the `HasElevation` property to `true`.

Data Types: `double`

RangeResolution — Range resolution of sonar

100 (default) | positive scalar

Range resolution of the sonar, specified as a positive scalar. The range resolution defines the minimum separation in range at which the sonar can distinguish between two targets. Units are in meters.

Data Types: `double`

RangeRateResolution — Range rate resolution of sonar

10 (default) | positive scalar

Range rate resolution of the sonar, specified as a positive scalar. The range rate resolution defines the minimum separation in range rate at which the sonar can distinguish between two targets. Units are in meters per second.

Dependencies

To enable this property, set the `HasRangeRate` property to `true`.

Data Types: `double`

AzimuthBiasFraction — Azimuth bias fraction

0.1 (default) | nonnegative scalar

Azimuth bias fraction of the sonar, specified as a nonnegative scalar. The azimuth bias is expressed as a fraction of the azimuth resolution specified in `AzimuthResolution`. This value sets a lower bound on the azimuthal accuracy of the sonar. This value is dimensionless.

Data Types: `double`

ElevationBiasFraction — Elevation bias fraction

0.1 (default) | nonnegative scalar

Elevation bias fraction of the sonar, specified as a nonnegative scalar. Elevation bias is expressed as a fraction of the elevation resolution specified by the value of the `ElevationResolution` property. This value sets a lower bound on the elevation accuracy of the sonar. This value is dimensionless.

Dependencies

To enable this property, set the `HasElevation` property to `true`.

Data Types: `double`

RangeBiasFraction — Range bias fraction

`0.05` (default) | nonnegative scalar

Range bias fraction of the sonar, specified as a nonnegative scalar. Range bias is expressed as a fraction of the range resolution specified in `RangeResolution`. This property sets a lower bound on the range accuracy of the sonar. This value is dimensionless.

Data Types: `double`

RangeRateBiasFraction — Range rate bias fraction

`0.05` (default) | nonnegative scalar

Range rate bias fraction of the sonar, specified as a nonnegative scalar. Range rate bias is expressed as a fraction of the range rate resolution specified in `RangeRateResolution`. This property sets a lower bound on the range-rate accuracy of the sonar. This value is dimensionless.

Dependencies

To enable this property, set the `HasRangeRate` property to `true`.

Data Types: `double`

HasRangeRate — Enable sonar to measure range rate

`false` (default) | `true`

Enable the sonar to measure target range rates, specified as `false` or `true`. Set this property to `true` to model a sonar sensor that can measure target range rate. Set this property to `false` to model a sonar sensor that cannot measure range rate.

Data Types: `logical`

HasRangeAmbiguities — Enable range ambiguities

`false` (default) | `true`

Enable range ambiguities, specified as `false` or `true`. Set this property to `true` to enable range ambiguities by the sensor. In this case, the sensor cannot resolve range ambiguities for targets at ranges beyond the `MaxUnambiguousRange` are wrapped into the interval `[0, MaxUnambiguousRange]`. When `false`, targets are reported at their unambiguous range.

Data Types: `logical`

HasRangeRateAmbiguities — Enable range-rate ambiguities

`false` (default) | `true`

Enable range-rate ambiguities, specified as `false` or `true`. Set to `true` to enable range-rate ambiguities by the sensor. When `true`, the sensor does not resolve range rate ambiguities and target range rates beyond the `MaxUnambiguousRadialSpeed` are wrapped into the interval `[0, MaxUnambiguousRadialSpeed]`. When `false`, targets are reported at their unambiguous range rate.

Dependencies

To enable this property, set the `HasRangeRate` property to `true`.

Data Types: `logical`

MaxUnambiguousRange — Maximum unambiguous detection range

100e3 (default) | positive scalar

Maximum unambiguous range, specified as a positive scalar. Maximum unambiguous range defines the maximum range for which the sonar can unambiguously resolve the range of a target. When `HasRangeAmbiguities` is set to `true`, targets detected at ranges beyond the maximum unambiguous range are wrapped into the range interval `[0, MaxUnambiguousRange]`. This property applies to true target detections when you set the `HasRangeAmbiguities` property to `true`.

This property also applies to false target detections when you set the `HasFalseAlarms` property to `true`. In this case, the property defines the maximum range for false alarms.

Units are in meters.

Example: `5e3`

Dependencies

To enable this property, set the `HasRangeAmbiguities` property to `true` or set the `HasFalseAlarms` property to `true`.

Data Types: `double`

MaxUnambiguousRadialSpeed — Maximum unambiguous radial speed

200 (default) | positive scalar

Maximum unambiguous radial speed, specified as a positive scalar. Radial speed is the magnitude of the target range rate. Maximum unambiguous radial speed defines the radial speed for which the sonar can unambiguously resolve the range rate of a target. When `HasRangeRateAmbiguities` is set to `true`, targets detected at range rates beyond the maximum unambiguous radial speed are wrapped into the range rate interval `[-MaxUnambiguousRadialSpeed, MaxUnambiguousRadialSpeed]`. This property applies to true target detections when you set `HasRangeRateAmbiguities` property to `true`.

This property also applies to false target detections obtained when you set both the `HasRangeRate` and `HasFalseAlarms` properties to `true`. In this case, the property defines the maximum radial speed for which false alarms can be generated.

Units are in meters per second.

Dependencies

To enable this property, set `HasRangeRate` and `HasRangeRateAmbiguities` to `true` and/or set `HasRangeRate` and `HasFalseAlarms` to `true`.

Data Types: `double`

HasINS — Enable inertial navigation system (INS) input

false (default) | true

Enable the optional input argument that passes the current estimate of the sensor platform pose to the sensor, specified as `false` or `true`. When `true`, pose information is added to the

MeasurementParameters structure of the reported detections. Pose information lets tracking and fusion algorithms estimate the state of the target detections in the north-east-down (NED) frame.

Data Types: `logical`

HasNoise — Enable addition of noise to sonar sensor measurements

`true` (default) | `false`

Enable addition of noise to sonar sensor measurements, specified as `true` or `false`. Set this property to `true` to add noise to the sonar measurements. Otherwise, the measurements have no noise. Even if you set `HasNoise` to `false`, the object still computes the `MeasurementNoise` property of each detection.

Data Types: `logical`

HasFalseAlarms — Enable creating false alarm sonar detections

`true` (default) | `false`

Enable creating false alarm sonar measurements, specified as `true` or `false`. Set this property to `true` to report false alarms. Otherwise, only actual detections are reported.

Data Types: `logical`

MaxNumDetectionsSource — Source of maximum number of detections reported

'Auto' (default) | 'Property'

Source of maximum number of detections reported by the sensor, specified as 'Auto' or 'Property'. When this property is set to 'Auto', the sensor reports all detections. When this property is set to 'Property', the sensor reports up to the number of detections specified by the `MaxNumDetections` property.

Data Types: `char`

MaxNumDetections — Maximum number of reported detections

50 (default) | positive integer

Maximum number of detections reported by the sensor, specified as a positive integer. Detections are reported in order of distance to the sensor until the maximum number is reached.

Dependencies

To enable this property, set the `MaxNumDetectionsSource` property to 'Property'.

Data Types: `double`

DetectionCoordinates — Coordinate system of reported detections

'Body' (default) | 'Scenario' | 'Sensor rectangular' | 'Sensor spherical'

Coordinate system of reported detections, specified as:

- 'Scenario' — Detections are reported in the rectangular scenario coordinate frame. The scenario coordinate system is defined as the local NED frame at simulation start time. To enable this value, set the `HasINS` property to `true`.
- 'Body' — Detections are reported in the rectangular body system of the sensor platform.
- 'Sensor rectangular' — Detections are reported in the sonar sensor rectangular body coordinate system.

- 'Sensor spherical' — Detections are reported in a spherical coordinate system derived from the sensor rectangular body coordinate system. This coordinate system is centered at the sonar sensor and aligned with the orientation of the sonar on the platform.

Example: 'Sensor spherical'

Data Types: char

Usage

Syntax

```
dets = sensor(sonarsigs,simTime)
dets = sensor(sonarsigs,txconfigs,simTime)
dets = sensor(___,ins,simTime)
[dets,numDets,config] = sensor(___)
```

Description

`dets = sensor(sonarsigs,simTime)` creates passive detections, `dets`, from sonar emissions, `sonarsigs`, at the current simulation time, `simTime`. The sensor generates detections at the rate defined by the `UpdateRate` property.

`dets = sensor(sonarsigs,txconfigs,simTime)` also specifies emitter configurations, `txconfigs`, at the current simulation time.

`dets = sensor(___,ins,simTime)` also specifies the inertial navigation system (INS) estimated sensor platform pose, `ins`. INS information is used by tracking and fusion algorithms to estimate the target positions in the NED frame.

To enable this syntax, set the `HasINS` property to `true`.

`[dets,numDets,config] = sensor(___)` also returns the number of valid detections reported, `numValidDets`, and the configuration of the sensor, `config`, at the current simulation time.

Input Arguments

sonarsigs — Sonar emissions

array of sonar emission objects

Sonar emissions, specified as an array of `sonarEmission` objects.

txconfigs — Emitter configurations

array of structures

Emitter configurations, specified as an array of structures. Each structure has these fields:

Field	Description
EmitterIndex	Unique emitter index, returned as a positive integer.

<code>IsValidTime</code>	Valid emission time, returned as 0 or 1. <code>IsValidTime</code> is 0 when emitter updates are requested at times that are between update intervals specified by the <code>UpdateInterval</code> property.
<code>IsScanDone</code>	Whether the emitter has completed a scan, returned as <code>true</code> or <code>false</code> .
<code>FieldOfView</code>	Field of view of the emitter, returned as a two-element vector [azimuth; elevation] in degrees.
<code>MeasurementParameters</code>	Emitter measurement parameters, returned as an array of structures containing the coordinate frame transforms needed to transform positions and velocities in the top-level frame to the current emitter frame.

Data Types: `struct`

ins – Platform pose from INS

structure

Sensor platform pose obtained from the inertial navigation system (INS), specified as a structure.

Platform pose information from an inertial navigation system (INS) is a structure with these fields:

Field	Definition
<code>Position</code>	Position in the navigation frame, specified as a real-valued 1-by-3 vector. Units are in meters.
<code>Velocity</code>	Velocity in the navigation frame, specified as a real-valued 1-by-3 vector. Units are in meters per second.
<code>Orientation</code>	Orientation with respect to the navigation frame, specified as a quaternion or a 3-by-3 real-valued rotation matrix. The rotation is from the navigation frame to the current INS body frame. This is also referred to as a "parent to child" rotation.

Dependencies

To enable this argument, set the `HasINS` property to `true`.

Data Types: `struct`

simTime – Current simulation time

nonnegative scalar

Current simulation time, specified as a positive scalar. The `trackingScenario` object calls the sonar sensor at regular time intervals. The sonar sensor generates new detections at intervals defined by the `UpdateInterval` property. The value of the `UpdateInterval` property must be an integer multiple of the simulation time interval. Updates requested from the sensor between update intervals contain no detections. Units are in seconds.

Example: 10.5

Data Types: double

Output Arguments

dets — sensor detections

cell array of `objectDetection` objects

Sensor detections, returned as a cell array of `objectDetection` objects. Each object has these properties:

Property	Definition
Time	Measurement time
Measurement	Object measurements
MeasurementNoise	Measurement noise covariance matrix
SensorIndex	Unique ID of the sensor
ObjectClassID	Object classification
ObjectAttributes	Additional information passed to tracker
MeasurementParameters	Parameters used by initialization functions of nonlinear Kalman tracking filters

Measurement and MeasurementNoise are reported in the coordinate system specified by the `DetectionCoordinates` property.

numDets — Number of detections

nonnegative integer

Number of detections reported, returned as a nonnegative integer.

- When the `MaxNumDetectionsSource` property is set to 'Auto', `numDets` is set to the length of `dets`.
- When the `MaxNumDetectionsSource` property is set to 'Property', `dets` is a cell array with length determined by the `MaxNumDetections` property. No more than `MaxNumDetections` number of detections are returned. If the number of detections is fewer than `MaxNumDetections`, the first `numDets` elements of `dets` hold valid detections. The remaining elements of `dets` are set to the default value.

Data Types: double

config — Current sensor configuration

structure

Current sensor configuration, specified as a structure. This output can be used to determine which objects fall within the sonar beam during object execution.

Field	Description
SensorIndex	Unique sensor index, returned as a positive integer.

IsValidTime	Valid detection time, returned as true or false. IsValidTime is false when detection updates are requested between update intervals specified by the update rate.
IsScanDone	IsScanDone is true when the sensor has completed a scan.
FieldOfView	Field of view of the sensor, returned as a 2-by-1 vector of positive real values, [azfov;elfov]. azfov and elfov represent the field of view in azimuth and elevation, respectively.
MeasurementParameters	Sensor measurement parameters, returned as an array of structures containing the coordinate frame transforms needed to transform positions and velocities in the top-level frame to the current sensor frame.

Data Types: struct

Object Functions

To use an object function, specify the System object as the first input argument. For example, to release system resources of a System object named obj, use this syntax:

```
release(obj)
```

Specific to sonarSensor

coverageConfig Sensor and emitter coverage configuration
 perturbations Perturbation defined on object
 perturb Apply perturbations to object

Common to All System Objects

step Run System object algorithm
 release Release resources and allow changes to System object property values and input characteristics
 reset Reset internal states of System object

Examples

Detect Sonar Emission with Passive Sensor

Create a sonar emission and then detect the emission using a sonarSensor object.

First, create a sonar emission.

```
orient = quaternion([180 0 0], 'eulerd', 'zyx', 'frame');
sonarSig = sonarEmission('PlatformID',1,'EmitterIndex',1, ...
    'OriginPosition',[30 0 0],'Orientation',orient, ...
    'SourceLevel',140,'TargetStrength',100);
```

Then create a passive sonar sensor.

```

sensor = sonarSensor(1, 'No scanning');

Detect the sonar emission.

time = 0;
[dets, numDets, config] = sensor(sonarSig,time)

dets = 1x1 cell array
      {1x1 objectDetection}

numDets = 1

config = struct with fields:
    SensorIndex: 1
    IsValidTime: 1
    IsScanDone: 1
    FieldOfView: [1 5]
    MeasurementParameters: [1x1 struct]

```

More About

Object Detections

Measurements

The sensor measures the coordinates of the target. The `Measurement` and `MeasurementNoise` values are reported in the coordinate system specified by the `DetectionCoordinates` property of the sensor.

When the `DetectionCoordinates` property is `'Scenario'`, `'Body'`, or `'Sensor_rectangular'`, the `Measurement` and `MeasurementNoise` values are reported in rectangular coordinates. Velocities are only reported when the range rate property, `HasRangeRate`, is `true`.

When the `DetectionCoordinates` property is `'Sensor_spherical'`, the `Measurement` and `MeasurementNoise` values are reported in a spherical coordinate system derived from the sensor rectangular coordinate system. Elevation and range rate are only reported when `HasElevation` and `HasRangeRate` are `true`.

Measurements are ordered as [azimuth, elevation, range, range rate]. Reporting of elevation and range rate depends on the corresponding `HasElevation` and `HasRangeRate` property values. Angles are in degrees, range is in meters, and range rate is in meters per second.

Measurement Coordinates

DetectionCoordinates	Measurement and Measurement Noise Coordinates		
'Scenario'	Coordinate Dependence on HasRangeRate		
'Body'	HasRangeRate	Coordinates	
'Sensor rectangular'	true	[x; y; z; vx; vy; vz]	
	false	[x; y; z]	
'Sensor spherical'	Coordinate Dependence on HasRangeRate and HasElevation		
	HasRangeRate	HasElevation	Coordinates
	true	true	[az; el; rng; rr]
	true	false	[az; rng; rr]
	false	true	[az; el; rng]
false	false	[az; rng]	

Measurement Parameters

The MeasurementParameters property consists of an array of structures that describe a sequence of coordinate transformations from a child frame to a parent frame or the inverse transformations (see "Frame Rotation"). In most cases, the longest required sequence of transformations is Sensor → Platform → Scenario.

If the detections are reported in sensor spherical coordinates and HasINS is set to false, then the sequence consists only of one transformation from sensor to platform. In the transformation, the OriginPosition is same as the MountingLocation property of the sensor. The Orientation consists of two consecutive rotations. The first rotation, corresponding to the MountingAngles property of the sensor, accounts for the rotation from the platform frame (*P*) to the sensor mounting frame (*M*). The second rotation, corresponding to the azimuth and elevation angles of the sensor, accounts for the rotation from the sensor mounting frame (*M*) to the sensor scanning frame (*S*). In the *S* frame, the *x* direction is the boresight direction, and the *y* direction lies within the *x*-*y* plane of the sensor mounting frame (*M*).

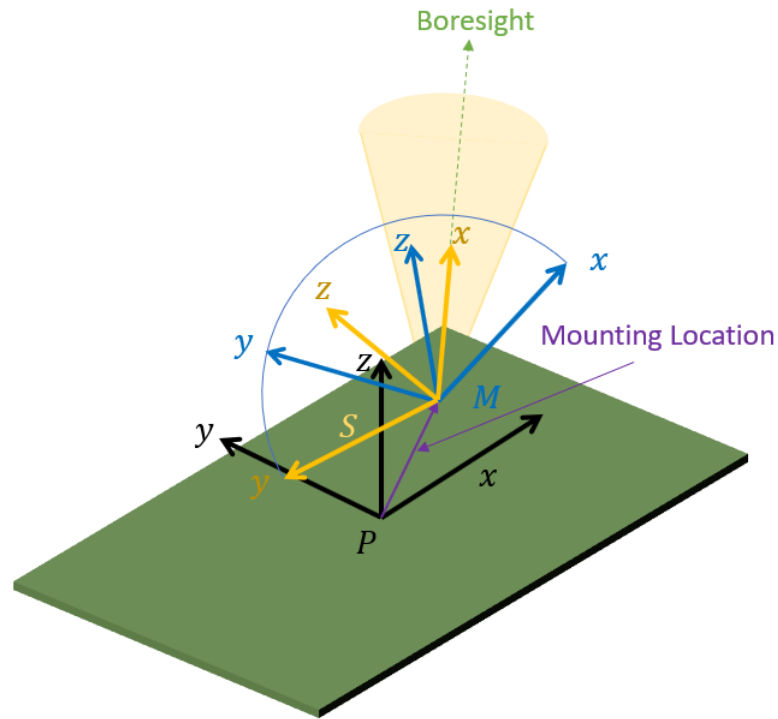

If `HasINS` is `true`, the sequence of transformations consists of two transformations - first from the scenario frame to the platform frame then from platform frame to the sensor scanning frame. In the first transformation, the `Orientation` is the rotation from the scenario frame to the platform frame, and the `OriginPosition` is the position of the platform frame origin relative to the scenario frame.

Trivially, if the detections are reported in platform rectangular coordinates and `HasINS` is set to `false`, the transformation consists only of the identity.

The fields of `MeasurementParameters` are shown here. Not all fields have to be present in the structure. The set of fields and their default values can depend on the type of sensor.

Field	Description
Frame	Enumerated type indicating the frame used to report measurements. When detections are reported using a rectangular coordinate system, <code>Frame</code> is set to <code>'rectangular'</code> . When detections are reported in spherical coordinates, <code>Frame</code> is set <code>'spherical'</code> for the first struct.
OriginPosition	Position offset of the origin of the child frame relative to the parent frame, represented as a 3-by-1 vector.
OriginVelocity	Velocity offset of the origin of the child frame relative to the parent frame, represented as a 3-by-1 vector.

Orientation	3-by-3 real-valued orthonormal frame rotation matrix. The direction of the rotation depends on the <code>IsParentToChild</code> field.
IsParentToChild	A logical scalar indicating if <code>Orientation</code> performs a frame rotation from the parent coordinate frame to the child coordinate frame. If <code>false</code> , <code>Orientation</code> performs a frame rotation from the child coordinate frame to the parent coordinate frame.
HasElevation	A logical scalar indicating if elevation is included in the measurement. For measurements reported in a rectangular frame, and if <code>HasElevation</code> is <code>false</code> , the measurements are reported assuming 0 degrees of elevation.
HasAzimuth	A logical scalar indicating if azimuth is included in the measurement.
HasRange	A logical scalar indicating if range is included in the measurement.
HasVelocity	A logical scalar indicating if the reported detections include velocity measurements. For measurements reported in the rectangular frame, if <code>HasVelocity</code> is <code>false</code> , the measurements are reported as <code>[x y z]</code> . If <code>HasVelocity</code> is <code>true</code> , measurements are reported as <code>[x y z vx vy vz]</code> .

Object Attributes

Object attributes contain additional information about a detection.

Attribute	Description
TargetIndex	Identifier of the platform, <code>PlatformID</code> , that generated the detection. For false alarms, this value is negative.
EmitterIndex	Index of the emitter from which the detected signal was emitted.
SNR	Detection signal-to-noise ratio in dB.
CenterFrequency	<ul style="list-style-type: none"> Measured center frequency of the detected sonar signal. Units are in Hz. This attribute is present only when the <code>DetectionMode</code> property is set to <code>'passive'</code>.
Bandwidth	<ul style="list-style-type: none"> Measured bandwidth of the detected sonar signal, Units are in Hz. This attribute is present only when the <code>DetectionMode</code> property is set to <code>'passive'</code>.

WaveformType	<ul style="list-style-type: none"> Identifier of the waveform type that was classified by a passive sensor for the detected signal. This attribute is present only when the DetectionMode property is set to 'passive'.
--------------	---

Convenience Syntaxes

The convenience syntaxes set several properties together to model a specific type of sonar.

No Scanning

Sets ScanMode to 'No scanning'.

Raster Scanning

This syntax sets these properties:

Property	Value
ScanMode	'Electronic'
HasElevation	true
ElectronicScanLimits	[-45 45; -10 0]

Rotator Scanning

This syntax sets these properties:

Property	Value
ScanMode	'Electronic'
FieldOfView	[1:10]
HasElevation	false or true
ElevationResolution	10/sqrt(12)

Sector Scanning

This syntax sets these properties:

Property	Value
ScanMode	'Electronic'
FieldOfView	[1;10]
HasElevation	false
ElectronicScanLimits	[-45 45; -10 0]
ElevationResolution	10/sqrt(12)

Extended Capabilities

C/C++ Code Generation

Generate C and C++ code using MATLAB® Coder™.

Usage notes and limitations:

See “System Objects in MATLAB Code Generation” (MATLAB Coder).

See Also

Objects

`objectDetection` | `sonarEmission` | `trackerGNN` | `trackerTOMHT`

Functions

`targetPoses`

Introduced in R2018b

sonarEmitter

Acoustic signals and interferences generator

Description

The `sonarEmitter` System object creates an emitter to simulate sonar emissions. You can use the `sonarEmitter` object in a scenario that detects and tracks moving and stationary platforms. Construct a scenario using `trackingScenario`.

A sonar emitter changes the look angle between updates by stepping the mechanical and electronic position of the beam in increments of the angular span specified in the `FieldOfView` property. The sonar emitter scans the total region in azimuth and elevation defined by the sonar mechanical and electronic scan limits, `MechanicalScanLimits` and `ElectronicScanLimits`, respectively. If the scan limits for azimuth or elevation are set to `[0 0]`, then no scanning is performed along that dimension for that scan mode. If the maximum mechanical scan rate for azimuth or elevation is set to zero, then no mechanical scanning is performed along that dimension.

To generate sonar detections:

- 1 Create the `sonarEmitter` object and set its properties.
- 2 Call the object with arguments, as if it were a function.

To learn more about how System objects work, see [What Are System Objects?](#).

Creation

Syntax

```
emitter = sonarEmitter(EmitterIndex)

emitter = sonarEmitter(EmitterIndex,'No scanning')
emitter = sonarEmitter(EmitterIndex,'Raster')
emitter = sonarEmitter(EmitterIndex,'Rotator')
emitter = sonarEmitter(EmitterIndex,'Sector')

emitter = sonarEmitter( ___,Name,Value)
```

Description

`emitter = sonarEmitter(EmitterIndex)` creates a sonar emitter object with default property values.

`emitter = sonarEmitter(EmitterIndex,'No scanning')` is a convenience syntax that creates a `sonarEmitter` that stares along the sonar transducer boresight direction. No mechanical or electronic scanning is performed. This syntax sets the `ScanMode` property to `'No scanning'`.

`emitter = sonarEmitter(EmitterIndex,'Raster')` is a convenience syntax that creates a `sonarEmitter` object that mechanically scans a raster pattern. The raster span is 90° in azimuth

from -45° to $+45^\circ$ and in elevation from the horizon to 10° above the horizon. See “Raster Scanning” on page 3-284 for the properties set by this syntax.

`emitter = sonarEmitter(EmitterIndex, 'Rotator')` is a convenience syntax that creates a `sonarEmitter` object that mechanically scans 360° in azimuth by mechanically rotating the sonar at a constant rate. When you set `HasElevation` to `true`, the sonar mechanically points towards the center of the elevation field of view. See “Rotator Scanning” on page 3-284 for the properties set by this syntax.

`emitter = sonarEmitter(EmitterIndex, 'Sector')` is a convenience syntax to create a `sonarEmitter` object that mechanically scans a 90° azimuth sector from -45° to $+45^\circ$. Setting `HasElevation` to `true`, points the sonar towards the center of the elevation field of view. You can change the `ScanMode` to `'Electronic'` to electronically scan the same azimuth sector. In this case, the sonar is not mechanically tilted in an electronic sector scan. Instead, beams are stacked electronically to process the entire elevation spanned by the scan limits in a single dwell. See “Sector Scanning” on page 3-284 for the properties set by this syntax.

`emitter = sonarEmitter(___, Name, Value)` sets properties using one or more name-value pairs after all other input arguments. Enclose each property name in quotes. For example, `sonarEmitter('CenterFrequency', 2e6)` creates a sonar emitter creates detections in the emitter Cartesian coordinate system and has a maximum detection range of 200 meters. If you specify the emitter index using the `EmitterIndex` property, you can omit the `EmitterIndex` input.

Properties

Unless otherwise indicated, properties are *nontunable*, which means you cannot change their values after calling the object. Objects lock when you call them, and the `release` function unlocks them.

If a property is *tunable*, you can change its value at any time.

For more information on changing property values, see System Design in MATLAB Using System Objects.

EmitterIndex — Unique sensor identifier

positive integer

Unique emitter identifier, specified as a positive integer. When creating a `sonarEmitter` system object, you must either specify the `EmitterIndex` as the first input argument in the creation syntax, or specify it as the value for the `EmitterIndex` property in the creation syntax.

Example: 2

Data Types: `double`

UpdateRate — Emitter update rate

1 (default) | positive scalar

Emitter update rate, specified as a positive scalar. The emitter generates new emissions at intervals defined by the reciprocal of the `UpdateRate` property. This interval must be an integer multiple of the simulation time interval defined in `trackingScenario`. Any update requested from the emitter between update intervals contains no emissions. Units are in hertz.

Example: 5

Data Types: `double`

MountingLocation — Emitter location on platform

[0 0 0] (default) | 1-by-3 real-valued vector

Emitter location on platform, specified as a 1-by-3 real-valued vector. This property defines the coordinates of the emitter with respect to the platform origin. The default value specifies that the emitter origin is at the origin of its platform. Units are in meters.

Example: [.2 0.1 0]

Data Types: double

MountingAngles — Orientation of emitter

[0 0 0] (default) | 3-element real-valued vector

Orientation of the emitter with respect to the platform, specified as a three-element real-valued vector. Each element of the vector corresponds to an intrinsic Euler angle rotation that carries the body axes of the platform to the emitter axes. The three elements define the rotations around the z, y, and x axes respectively, in that order. The first rotation rotates the platform axes around the z-axis. The second rotation rotates the carried frame around the rotated y-axis. The final rotation rotates carried frame around the carried x-axis. Units are in degrees.

Example: [10 20 -15]

Data Types: double

FieldOfView — Fields of view of sensor

[10;50] | 2-by-1 vector of positive scalar

Fields of view of sensor, specified as a 2-by-1 vector of positive scalars in degree, [azfov;elfov]. The field of view defines the total angular extent spanned by the sensor. The azimuth filed of view azfov must lie in the interval (0,360]. The elevation filed of view elfov must lie in the interval (0,180].

Example: [14;7]

Data Types: double

ScanMode — Scanning mode of sonar

'Mechanical' (default) | 'Electronic' | 'Mechanical and electronic' | 'No scanning'

Scanning mode of sonar, specified as 'Mechanical', 'Electronic', 'Mechanical and electronic', or 'No scanning'.

Scan Modes

ScanMode	Purpose
'Electronic'	The sonar scans electronically across the azimuth and elevation limits specified by the <code>ElectronicScanLimits</code> property. The scan direction increments by the sonar field of view angle between dwells.
'No scanning'	The sonar beam points along the antenna boresight defined by the <code>mountingAngles</code> property.

Example: 'No scanning'

Data Types: char

ElectronicScanLimits — Angular limits of electronic scan directions of sonar

[-45 45; -45 45] (default) | real-valued 1-by-2 row vector | real-valued 2-by-2 matrix

Angular limits of electronic scan directions of sonar, specified as a real-valued 1-by-2 row vector or a real-valued 2-by-2 matrix. The electronic scan limits define the minimum and maximum electronic angles the sonar can scan from its current mechanical direction.

When HasElevation is true, the scan limits take the form [minAz maxAz; minEl maxEl]. minAz and maxAz represent the minimum and maximum limits of the azimuth angle scan. minEl and maxEl represent the minimum and maximum limits of the elevation angle scan. When HasElevation is false, the scan limits take the form [minAz maxAz]. If you specify the scan limits as a 2-by-2 matrix but set HasElevation to false, the second row of the matrix is ignored.

Azimuthal scan limits and elevation scan limits must lie within the closed interval [-90° 90°]. Units are in degrees.

Example: [-90 90; 0 85]

Dependencies

To enable this property, set the ScanMode property to 'Electronic' or 'Mechanical and electronic'.

Data Types: double

ElectronicAngle — Current electronic scan angle

electronic scalar | nonnegative scalar

This property is read-only.

Current electronic scan angle of sonar, returned as a scalar or 1-by-2 column vector. When HasElevation is true, the scan angle takes the form [Az; El]. Az and El represent the azimuth and elevation scan angles, respectively. When HasElevation is false, the scan angle is a scalar representing the azimuth scan angle.

Dependencies

To enable this property, set the ScanMode property to 'Electronic' or 'Mechanical and electronic'.

Data Types: double

LookAngle — Look angle of emitter

scalar | real-valued 2-by-1 vector

This property is read-only.

Look angle of emitter, specified as a scalar or real-valued 2-by-1 vector. Look angle is a combination of the mechanical angle and electronic angle depending on the ScanMode property. When HasElevation is true, the look angle takes the form [Az; El]. Az and El represent the azimuth and elevation look angles, respectively. When HasElevation is false, the look angle is a scalar representing the azimuth look angle.

ScanMode	LookAngle
----------	-----------

'Mechanical'	MechanicalAngle
'Electronic'	ElectronicAngle
'Mechanical and Electronic'	MechanicalAngle + ElectronicAngle
'No scanning'	0

Data Types: double

HasElevation — Enable sonar elevation scan and measurements

false (default) | true

Enable the sonar to measure target elevation angles and to scan in elevation, specified as false or true. Set this property to true to model a sonar emitter that can estimate target elevation and scan in elevation.

Data Types: logical

SourceLevel — Sonar source level

140 (default) | scalar

Sonar source level, specified as a scalar. Source level is relative to the intensity of a sound wave having an rms pressure of 1 μ Pa. Units are in dB//1 μ Pa.

Data Types: double

CenterFrequency — Center frequency of sonar band

positive scalar

Center frequency of sonar band, specified as a positive scalar. Units are in hertz.

Example: 100e6

Data Types: double

Bandwidth — Sonar waveform bandwidth

positive scalar

Sonar waveform bandwidth, specified as a positive scalar. Units are in hertz.

Example: 100e3

Data Types: double

WaveformTypes — Types of detected waveforms

0 (default) | nonnegative integer-valued L -element vector

Types of detected waveforms, specified as a nonnegative integer-valued L -element vector.

Example: [1 4 5]

Data Types: double

ProcessingGain — Processing gain

0 (default) | scalar

Processing gain when demodulating an emitted signal waveform, specified as a scalar. Processing gain is achieved by emitting a signal over a bandwidth which is greater than the minimum bandwidth necessary to send the information contained in the signal. Units are in dB.

Example: 20

Data Types: double

Usage

Syntax

```
sonarsigs = emitter(platform,simTime)
[sonarsigs,config] = emitter(platform,simTime)
```

Description

`sonarsigs = emitter(platform,simTime)` creates sonar signals, `sonarsigs`, from emitter on the `platform` at the current simulation time, `simTime`. The emitter object can simultaneously generate signals from multiple emitters on the platform.

`[sonarsigs,config] = emitter(platform,simTime)` also returns the emitter configurations, `config`, at the current simulation time.

Input Arguments

platform — emitter platform

object | structure

Emitter platform, specified as a platform object, `Platform`, or a platform structure:

Field	Description
PlatformID	Unique identifier for the platform, specified as a scalar positive integer. This is a required field which has no default value.
ClassID	User-defined integer used to classify the type of target, specified as a nonnegative integer. Zero is reserved for unclassified platform types and is the default value.
Position	Position of target in scenario coordinates, specified as a real-valued 1-by-3 vector. This is a required field. There is no default value. Units are in meters.
Velocity	Velocity of platform in scenario coordinates, specified as a real-valued 1-by-3 vector. Units are in meters per second. The default is <code>[0 0 0]</code> .
Speed	Speed of the platform in the scenario frame specified as a real scalar. When speed is specified, the platform velocity is aligned with its orientation. Specify either the platform speed or velocity, but not both. Units are in meters per second The default is 0.

Field	Description
Acceleration	Acceleration of the platform in scenario coordinates specified as a 1-by-3 row vector in meters per second-squared. The default is [0 0 0].
Orientation	Orientation of the platform with respect to the local scenario NED coordinate frame, specified as a scalar quaternion or a 3-by-3 rotation matrix. Orientation defines the frame rotation from the local NED coordinate system to the current platform body coordinate system. Units are dimensionless. The default is quaternion(1,0,0,0).
AngularVelocity	Angular velocity of platform in scenario coordinates, specified as a real-valued 1-by-3 vector. The magnitude of the vector defines the angular speed. The direction defines the axis of clockwise rotation. Units are in degrees per second. The default is [0 0 0].
Signatures	Cell array of signatures defining the visibility of the platform to emitters and sensors in the scenario. The default is the cell array {rccSignature, irSignature, tsSignature}.

simTime – Current simulation time

nonnegative scalar

Current simulation time, specified as a positive scalar. The `trackingScenario` object calls the sonar emitter at regular time intervals. The sonar emitter generates new signals at intervals defined by the `UpdateInterval` property. The value of the `UpdateInterval` property must be an integer multiple of the simulation time interval. Updates requested from the emitter between update intervals contain no detections. Units are in seconds.

Example: 10.5

Data Types: double

Output Arguments

sonarsigs – Sonar emissions

array of sonar emission objects

Sonar emissions, returned as an array of `sonarEmission` objects.

config – Current emitter configuration

structure array

Current emitter configurations, returned as an array of structures.

Field	Description
-------	-------------

EmitterIndex	Unique emitter index, returned as a positive integer.
IsValidTime	Valid emission time, returned as 0 or 1. IsValidTime is 0 when emitter updates are requested at times that are between update intervals specified by the UpdateInterval property.
IsScanDone	Whether the emitter has completed a scan, returned as true or false.
FieldOfView	Field of view of the emitter, returned as a two-element vector [azimuth; elevation] in degrees.
MeasurementParameters	Emitter measurement parameters, returned as an array of structures containing the coordinate frame transforms needed to transform positions and velocities in the top-level frame to the current emitter frame.

Data Types: struct

Object Functions

To use an object function, specify the System object as the first input argument. For example, to release system resources of a System object named `obj`, use this syntax:

```
release(obj)
```

Specific to sonarEmitter

coverageConfig Sensor and emitter coverage configuration
 perturbations Perturbation defined on object
 perturb Apply perturbations to object

Common to All System Objects

step Run System object algorithm
 release Release resources and allow changes to System object property values and input characteristics
 reset Reset internal states of System object

Examples

Reflect Sonar Emission from Platform within Tracking Scenario

Reflect a sonar emission from a platform defined within a trackingScenario.

Create a tracking scenario object.

```
scenario = trackingScenario;
```

Create an sonarEmitter.

```
emitter = sonarEmitter(1);
```

Mount the emitter on a platform within the scenario.

```
plat = platform(scenario, 'Emitters', emitter);
```

Add another platform to reflect the emitted signal.

```
tgt = platform(scenario);
tgt.Trajectory.Position = [30 0 0];
```

Emit the signal using the emit object function of a platform .

```
txSigs = emit(plat, scenario.SimulationTime)
```

```
txSigs = 1x1 cell array
        {1x1 sonarEmission}
```

Reflect the signal from the platforms in the scenario.

```
sigs = underwaterChannel(txSigs, scenario.Platforms)
```

```
sigs = 1x1 cell array
        {1x1 sonarEmission}
```

More About

Convenience Syntaxes

The convenience syntaxes set several properties together to model a specific type of sonar emitter.

No Scanning

Sets ScanMode to 'No scanning'.

Raster Scanning

This syntax sets these properties:

Property	Value
ScanMode	'Electronic'
HasElevation	true
ElectronicScanLimits	[-45 45; -10 0]

Rotator Scanning

This syntax sets these properties:

Property	Value
ScanMode	'Electronic'
FieldOfView	[1:10]
HasElevation	false or true
ElevationResolution	10/sqrt(12)

Sector Scanning

This syntax sets these properties:

Property	Value
ScanMode	'Electronic'
FieldOfView	[1;10]
HasElevation	false
ElectronicScanLimits	[-45 45; -10 0]
ElevationResolution	10/sqrt(12)

Extended Capabilities

C/C++ Code Generation

Generate C and C++ code using MATLAB® Coder™.

Usage notes and limitations:

See “System Objects in MATLAB Code Generation” (MATLAB Coder).

See Also

Classes

platform | sonarEmission

Functions

emissionsInBody | targetPoses

Objects

sonarSensor

Introduced in R2018b

geoTrajectory

Waypoint trajectory in geodetic coordinates

Description

The `geoTrajectory` System object generates trajectories based on waypoints in geodetic coordinates. When you create the System object, you can specify the time of arrival, velocity, and orientation at each waypoint. The `geoTrajectory` System object involves three coordinate systems. For more details, see “Coordinate Frames in Geo Trajectory” on page 3-196.

To generate an Earth-centered waypoint trajectory in geodetic coordinates:

- 1 Create the `geoTrajectory` object and set its properties.
- 2 Call the object as if it were a function.

To learn more about how System objects work, see [What Are System Objects?](#).

Creation

Syntax

```
trajectory = geoTrajectory(Waypoints,TimeOfArrival)
trajectory = geoTrajectory(Waypoints,TimeOfArrival,Name,Value)
```

Description

`trajectory = geoTrajectory(Waypoints,TimeOfArrival)` returns a `geoTrajectory` System object, `trajectory`, based on the specified geodetic waypoints, `Waypoints`, and the corresponding time, `TimeOfArrival`.

`trajectory = geoTrajectory(Waypoints,TimeOfArrival,Name,Value)` sets each creation argument or property `Name` to the specified `Value`. Unspecified properties and creation arguments have default or inferred values.

Example: `trajectory = geoTrajectory([10,10,1000;10,11,1100],[0,3600])` creates a geodetic waypoint trajectory System object, `geojectory`, that moves one degree in longitude and 100 meters in altitude in one hour.

Creation Arguments

Creation arguments are properties which are set during creation of the System object and cannot be modified later. If you do not explicitly set a creation argument value, the property value is inferred.

You can specify `Waypoints` and `TimeOfArrival` as value-only arguments or name-value pairs.

Properties

Unless otherwise indicated, properties are *nontunable*, which means you cannot change their values after calling the object. Objects lock when you call them, and the `release` function unlocks them.

If a property is *tunable*, you can change its value at any time.

For more information on changing property values, see System Design in MATLAB Using System Objects.

SampleRate — Sample rate of trajectory (Hz)

1 (default) | positive scalar

Sample rate of the trajectory in Hz, specified as a positive scalar.

Tunable: Yes

Data Types: `double`

SamplesPerFrame — Number of samples per output frame

1 (default) | positive integer

Number of samples per output frame, specified as a positive integer.

Tunable: Yes

Data Types: `double`

Waypoints — Positions in geodetic coordinates [deg deg m]

[0 0 0] (default) | N -by-3 matrix

Positions in geodetic coordinates, specified as an N -by-3 matrix. N is the number of waypoints. In each row, the three elements represent the latitude in degrees, longitude in degrees, and altitude above the WGS84 reference ellipsoid in meters of the geodetic waypoint. When $N = 1$, the trajectory is at a stationary position.

Dependencies

To set this property, you must also set valid values for the `TimeOfArrival` property.

Data Types: `double`

TimeOfArrival — Time at each waypoint (s)

`Inf` (default) | N -element column vector of nonnegative increasing numbers

Time at each waypoint in seconds, specified as an N -element column vector. The number of samples, N , must be the same as the number of samples (rows) defined by `Waypoints`. If the trajectory is stationary (only one waypoint specified in the `Waypoints` property), then the specified property value for `TimeOfArrival` is ignored and the default value, `Inf`, is used.

Dependencies

To set this property, you must also set valid values for the `Waypoints` property.

Data Types: `double`

Velocities — Velocity in local reference frame at each waypoint (m/s)

[0 0 0] (default) | N -by-3 matrix

Velocity in the local reference frame at each waypoint in meters per second, specified as an N -by-3 matrix. The number of samples, N , must be the same as the number of samples (rows) defined by `Waypoints`.

- If you do not specify the velocity, the object infers velocities from waypoints.
- If you specify the velocity as a non-zero value, the object obtains the course of the trajectory accordingly.

Data Types: `double`

Course — Angle between velocity direction and North (degree)

N -element vector of scalars

Angle between the velocity direction and the North direction, specified as an N -element vector of scalars in degrees. The number of samples, N , must be the same as the number of samples (rows) defined by `Waypoints`. If neither `Velocities` nor `Course` is specified, course is inferred from the waypoints.

Dependencies

To set this property, do not specify the `Velocities` property during object creation.

Data Types: `double`

GroundSpeed — Groundspeed at each waypoint (m/s)

N -element real vector

Groundspeed at each waypoint, specified as an N -element real vector in m/s. If you do not specify the property, it is inferred from the waypoints. The number of samples, N , must be the same as the number of samples (rows) defined by `Waypoints`.

Dependencies

To set this property, do not specify the `Velocities` property during object creation.

Data Types: `double`

Climbrate — Climb rate at each waypoint (m/s)

N -element real vector

Climb rate at each waypoint, specified as an N -element real vector in degrees. The number of samples, N , must be the same as the number of samples (rows) defined by `Waypoints`. If neither `Velocities` nor `Course` is specified, climb rate is inferred from the waypoints.

Dependencies

To set this property, do not specify the `Velocities` property during object creation.

Data Types: `double`

Orientation — Orientation at each waypoint

N -element quaternion column vector | 3-by-3-by- N array of real numbers

Orientation at each waypoint, specified as an N -element quaternion column vector or as a 3-by-3-by- N array of real numbers in which each 3-by-3 array is a rotation matrix. The number of quaternions or rotation matrices, N , must be the same as the number of samples (rows) defined by `Waypoints`.

Each quaternion or rotation matrix is a frame rotation from the local reference frame (NED or ENU) at the waypoint to the body frame of the platform on the trajectory.

Data Types: `quaternion` | `double`

AutoPitch — Align pitch angle with direction of motion

`false` (default) | `true`

Align pitch angle with the direction of motion, specified as `true` or `false`. When specified as `true`, the pitch angle aligns with the direction of motion. If specified as `false`, the pitch angle is set to zero.

Dependencies

To set this property, the `Orientation` property must not be specified during object creation.

AutoBank — Align roll angle to counteract centripetal force

`false` (default) | `true`

Align the roll angle to counteract the centripetal force, specified as `true` or `false`. When specified as `true`, the roll angle automatically counteracts the centripetal force. If specified as `false`, the roll angle is set to zero (flat orientation).

Dependencies

To set this property, do not specify the `Orientation` property during object creation.

ReferenceFrame — Local reference frame of trajectory

`'NED'` (default) | `'ENU'`

Local reference frame of the trajectory, specified as `'NED'` (North-East-Down) or `'ENU'` (East-North-Up). The local reference frame corresponds to the current waypoint of the trajectory. The velocity, acceleration, and orientation of the platform are reported in the local reference frame. For more details, see “Coordinate Frames in Geo Trajectory” on page 3-196.

Usage

Syntax

```
[positionLLA,orientation,velocity,acceleration,angularVelocity,ecef2ref] =  
trajectory()
```

Description

`[positionLLA,orientation,velocity,acceleration,angularVelocity,ecef2ref] = trajectory()` outputs a frame of trajectory data based on specified creation arguments and properties, where `trajectory` is a `geoTrajectory` object.

Output Arguments

positionLLA — Geodetic positions in latitude, longitude, and altitude (deg deg m)

M-by-3 matrix

Geodetic positions in latitude, longitude, and altitude, returned as an M -by-3 matrix. In each row, the three elements represent the latitude in degrees, longitude in degrees, and altitude above the WGS84 reference ellipsoid in meters of the geodetic waypoint.

M is specified by the `SamplesPerFrame` property.

Data Types: `double`

orientation — Orientation in local reference coordinate system

M -element quaternion column vector | 3-by-3-by- M real array

Orientation in the local reference coordinate system, returned as an M -by-1 quaternion column vector or as a 3-by-3-by- M real array in which each 3-by-3 array is a rotation matrix.

Each quaternion or rotation matrix is a frame rotation from the local reference frame (NED or ENU) to the body frame.

M is specified by the `SamplesPerFrame` property.

Data Types: `double`

velocity — Velocity in local reference coordinate system (m/s)

M -by-3 matrix

Velocity in the local reference coordinate system in meters per second, returned as an M -by-3 matrix.

M is specified by the `SamplesPerFrame` property.

Data Types: `double`

acceleration — Acceleration in local reference coordinate system (m/s²)

M -by-3 matrix

Acceleration in the local reference coordinate system in meters per second squared, returned as an M -by-3 matrix.

M is specified by the `SamplesPerFrame` property.

Data Types: `double`

angularVelocity — Angular velocity in local reference coordinate system (rad/s)

M -by-3 matrix

Angular velocity in the local reference coordinate system in radians per second, returned as an M -by-3 matrix.

M is specified by the `SamplesPerFrame` property.

Data Types: `double`

ecef2ref — Orientation of local reference frame with respect to ECEF frame

M -element quaternion column vector | 3-by-3-by- M real array

Orientation of the local reference frame with respect to the ECEF (Earth-Centered-Earth-Fixed) frame, returned as an M -by-1 quaternion column vector or as a 3-by-3-by- M real array in which each 3-by-3 array is a rotation matrix.

Each quaternion or 3-by-3 rotation matrix is a frame rotation from the ECEF frame to the local reference frame (NED or ENU) corresponding to the current waypoint.

M is specified by the `SamplesPerFrame` property.

Data Types: `double`

Object Functions

To use an object function, specify the System object as the first input argument. For example, to release system resources of a System object named `obj`, use this syntax:

```
release(obj)
```

Specific to `geoTrajectory`

`lookupPose` Obtain pose of geodetic trajectory for a certain time
`perturbations` Perturbation defined on object
`perturb` Apply perturbations to object

Common to All System Objects

`clone` Create duplicate System object
`step` Run System object algorithm
`release` Release resources and allow changes to System object property values and input characteristics
`reset` Reset internal states of System object
`isDone` End-of-data status

Examples

Create `geoTrajectory` and Look Up Pose

Create a `geoTrajectory` with starting LLA at [15 15 0] and ending LLA at [75 75 100]. Set the flight time to ten hours. Sample the trajectory every 1000 seconds.

```
startLLA = [15 15 0];  
endLLA = [75 75 100];  
timeOfTravel = [0 3600*10];  
sampleRate = 0.001;
```

```
trajectory = geoTrajectory([startLLA;endLLA],timeOfTravel,'SampleRate',sampleRate);
```

Output the LLA waypoints of the trajectory.

```
positionsLLA = startLLA;  
while ~isDone(trajectory)  
    positionsLLA = [positionsLLA;trajectory()];  
end  
positionsLLA
```

```
positionsLLA = 37×3
```

```
15.0000 15.0000 0  
16.6667 16.6667 2.7778
```

```

18.3333  18.3333  5.5556
20.0000  20.0000  8.3333
21.6667  21.6667  11.1111
23.3333  23.3333  13.8889
25.0000  25.0000  16.6667
26.6667  26.6667  19.4444
28.3333  28.3333  22.2222
30.0000  30.0000  25.0000
:

```

Look up the Cartesian waypoints of the trajectory in the ECEF frame by using the `lookupPose` function.

```

sampleTimes = 0:1000:3600*10;
n = length(sampleTimes);
positionsCart = lookupPose(trajjectory, sampleTimes, 'ECEF');

```

Visualize the results in the ECEF frame.

```

figure()
km = 1000;
plot3(positionsCart(1,1)/km, positionsCart(1,2)/km, positionsCart(1,3)/km, 'b*');
hold on;
plot3(positionsCart(end,1)/km, positionsCart(end,2)/km, positionsCart(end,3)/km, 'bo');
plot3(positionsCart(:,1)/km, positionsCart(:,2)/km, positionsCart(:,3)/km, 'b');

plot3([0 positionsCart(1,1)]/km, [0 positionsCart(1,2)]/km, [0 positionsCart(1,3)]/km, 'k:');
plot3([0 positionsCart(end,1)]/km, [0 positionsCart(end,2)]/km, [0 positionsCart(end,3)]/km, 'k:');
xlabel('x (km)'); ylabel('y (km)'); zlabel('z (km)');
legend('Start position', 'End position', 'Trajectory')

```

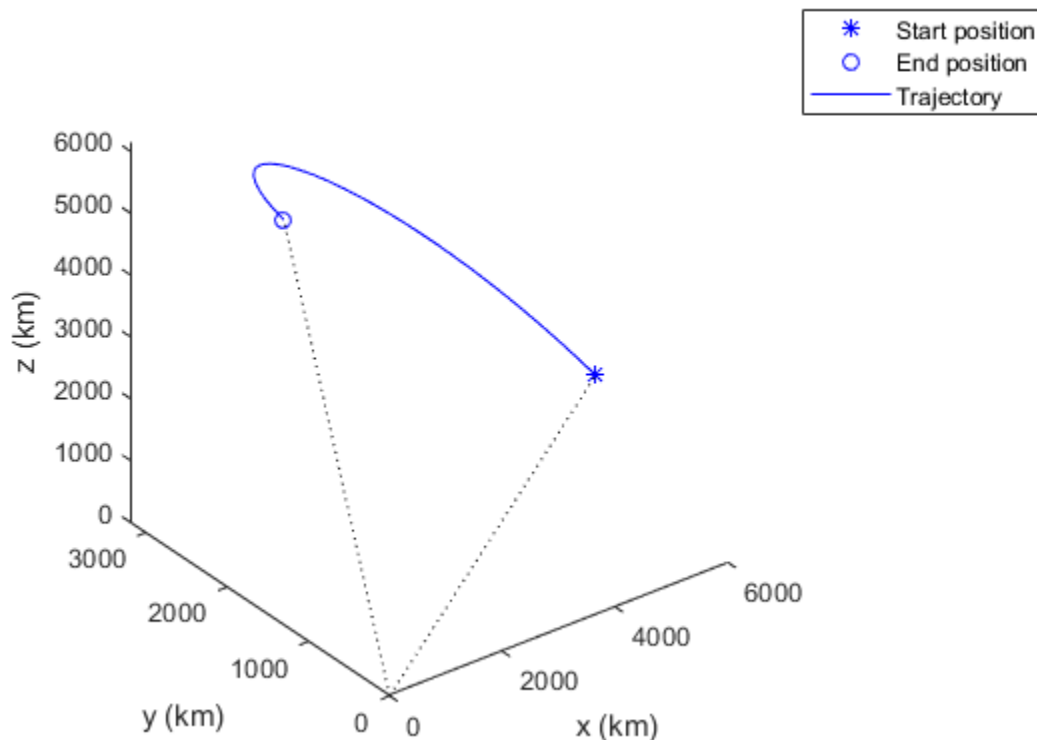

Algorithms

Coordinate Frames in Geo Trajectory

The geoTrajectory System object involves three coordinate frames:

- ECEF (Earth-Centered-Earth-Fixed) frame
- Local reference frame: local NED (North-East-Down) or ENU (East-North-Up) frame
- Target body frame

The figure shows an Earth-centered trajectory with two waypoints highlighted. The figure uses the **NED** local reference frame as an example, but you can certainly use the ENU local reference frame. In the figure,

- E_x , E_y , and E_z are the three axes of the ECEF frame, which is fixed on the Earth.
- B_x , B_y , and B_z are the three axes of the target body frame, which is fixed on the target.
- N , E , and D are the three axes of the local NED frame. The figure highlights two local NED reference frames, $N_1-E_1-D_1$ and $N_2-E_2-D_2$. The origin of each local NED frame is the Earth surface point corresponding to the trajectory waypoint based on the WGS84 ellipsoid model. The horizontal plane of the local NED frame is tangent to the WGS84 ellipsoid model's surface.

λ and ϕ are the geodetic longitude and latitude, respectively. The orientation of the target by using the NED local frame convention is defined as the rotation from the local NED frame to the target's body frame, such as the rotation from $N_1-E_1-D_1$ to $B_x-B_y-B_z$.

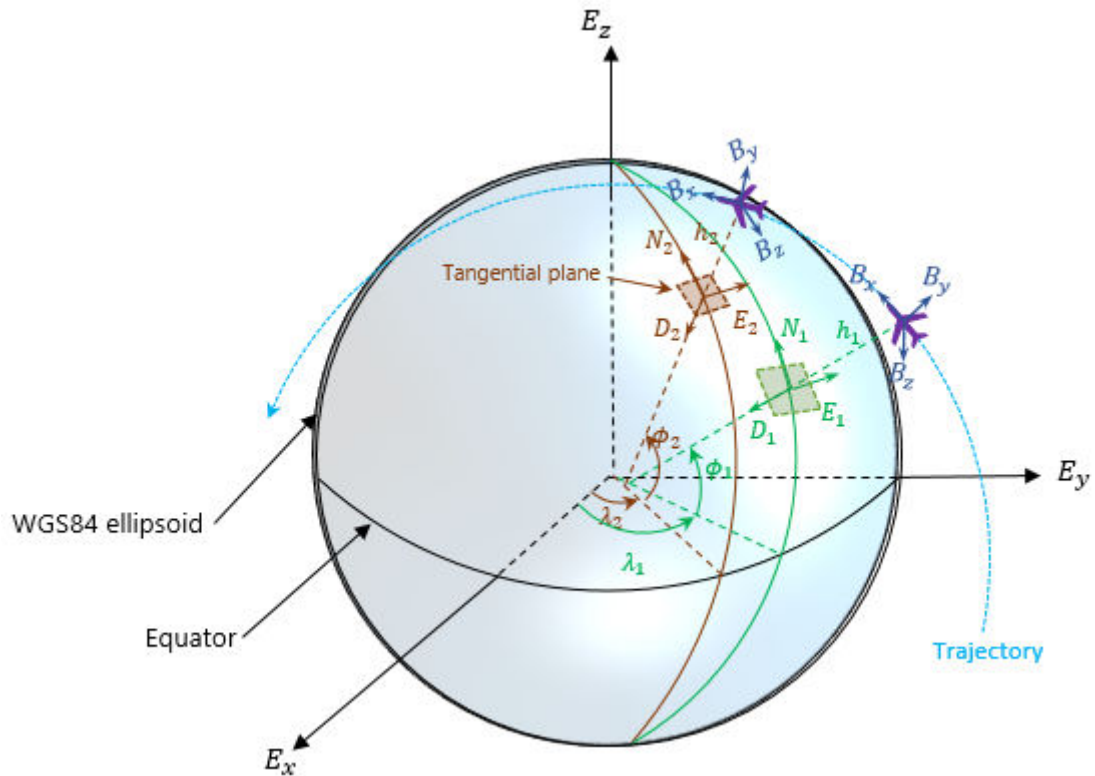

Extended Capabilities

C/C++ Code Generation

Generate C and C++ code using MATLAB® Coder™.

Usage notes and limitations:

See “System Objects in MATLAB Code Generation” (MATLAB Coder).

See Also

kinematicTrajectory | waypointTrajectory

Introduced in R2018b

lookupPose

Obtain pose of geodetic trajectory for a certain time

Syntax

```
[position,orientation,velocity,acceleration,angularVelocity,ecef2ref] =  
lookupPose(traj,sampleTimes)  
[ ___ ] = lookupPose(traj,sampleTimes,coordinateSystem)
```

Description

[position,orientation,velocity,acceleration,angularVelocity,ecef2ref] = lookupPose(traj,sampleTimes) returns the pose information of the waypoint trajectory at the specified sample times. If any sample time is beyond the duration of the trajectory, the corresponding pose information is returned as NaN.

[___] = lookupPose(traj,sampleTimes,coordinateSystem) additionally enables you to specify the format of the position output.

Examples

Create geoTrajectory and Look Up Pose

Create a geoTrajectory with starting LLA at [15 15 0] and ending LLA at [75 75 100]. Set the flight time to ten hours. Sample the trajectory every 1000 seconds.

```
startLLA = [15 15 0];  
endLLA = [75 75 100];  
timeOfTravel = [0 3600*10];  
sampleRate = 0.001;
```

```
trajectory = geoTrajectory([startLLA;endLLA],timeOfTravel,'SampleRate',sampleRate);
```

Output the LLA waypoints of the trajectory.

```
positionsLLA = startLLA;  
while ~isDone(trajectory)  
    positionsLLA = [positionsLLA;trajectory()];  
end
```

```
positionsLLA
```

```
positionsLLA = 37×3
```

```
15.0000    15.0000         0  
16.6667    16.6667    2.7778  
18.3333    18.3333    5.5556  
20.0000    20.0000    8.3333  
21.6667    21.6667   11.1111  
23.3333    23.3333   13.8889  
25.0000    25.0000   16.6667  
26.6667    26.6667   19.4444
```



```

28.3333  28.3333  22.2222
30.0000  30.0000  25.0000
⋮

```

Look up the Cartesian waypoints of the trajectory in the ECEF frame by using the `lookupPose` function.

```

sampleTimes = 0:1000:3600*10;
n = length(sampleTimes);
positionsCart = lookupPose(trajjectory,sampleTimes,'ECEF');

```

Visualize the results in the ECEF frame.

```

figure()
km = 1000;
plot3(positionsCart(1,1)/km,positionsCart(1,2)/km,positionsCart(1,3)/km, 'b*');
hold on;
plot3(positionsCart(end,1)/km,positionsCart(end,2)/km,positionsCart(end,3)/km, 'bo');
plot3(positionsCart(:,1)/km,positionsCart(:,2)/km,positionsCart(:,3)/km,'b');

plot3([0 positionsCart(1,1)]/km,[0 positionsCart(1,2)]/km,[0 positionsCart(1,3)]/km,'k:');
plot3([0 positionsCart(end,1)]/km,[0 positionsCart(end,2)]/km,[0 positionsCart(end,3)]/km,'k:');
xlabel('x (km)'); ylabel('y (km)'); zlabel('z (km)');
legend('Start position','End position', 'Trajectory')

```

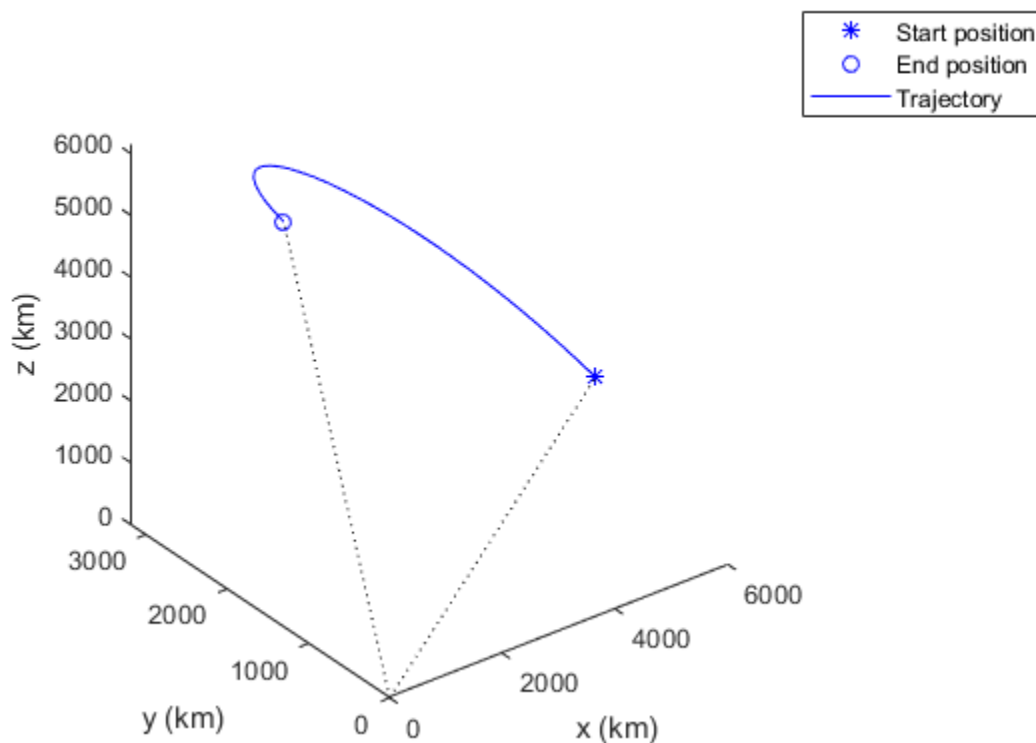

Input Arguments

traj — Geodetic trajectory

geoTrajectory object

Geodetic trajectory, specified as a geoTrajectory object.

sampleTimes — Sample times

K -element vector of nonnegative scalar

Sample times in seconds, specified as an K -element vector of nonnegative scalars.

coordinateSystem — Coordinate system to report positions

'LLA' (default) | 'ECEF'

Coordinate system to report positions, specified as:

- 'LLA' — Report positions as latitude in degrees, longitude in degrees, and altitude above the WGS84 reference ellipsoid in meters.
- 'ECEF' — Report positions as Cartesian coordinates in the ECEF (Earth-Centered-Earth-Fixed) coordinate frame in meters.

.

Output Arguments

position — Positions in local reference coordinate system (deg deg m)

K -by-3 matrix

Geodetic positions in local reference coordinate system, returned as a K -by-3 matrix. K is the number of SampleTimes.

- When the coordinateSystem input is specified as 'LLA', the three elements in each row represent the latitude in degrees, longitude in degrees, and altitude above the WGS84 reference ellipsoid in meters of the geodetic waypoint.
- When the coordinateSystem input is specified as 'ECEF', the three elements in each row represent the Cartesian position coordinates in the ECEF (Earth-Centered-Earth-Fixed) coordinate frame in meters.

Data Types: double

orientation — Orientation in local reference coordinate system

K -element quaternion column vector | 3-by-3-by- K real array

Orientation in the local reference coordinate system, returned as a K -by-1 quaternion column vector or as a 3-by-3-by- K real array in which each 3-by-3 matrix is a rotation matrix.

Each quaternion or rotation matrix is a frame rotation from the local reference frame (NED or ENU) at the waypoint to the body frame of the target on the trajectory.

K is the number of SampleTimes.

Data Types: double

velocity — Velocity in local reference coordinate system (m/s)*K*-by-3 matrix

Velocity in the local reference coordinate system in meters per second, returned as an *M*-by-3 matrix.

K is specified by the `SamplesPerFrame` property.

Data Types: `double`

acceleration — Acceleration in local reference coordinate system (m/s²)*K*-by-3 matrix

Acceleration in the local reference coordinate system in meters per second squared, returned as an *M*-by-3 matrix.

K is the number of `SampleTimes`.

Data Types: `double`

angularVelocity — Angular velocity in local reference coordinate system (rad/s)*K*-by-3 matrix

Angular velocity in the local reference coordinate system in radians per second, returned as a *K*-by-3 matrix.

K is the number of `SampleTimes`.

Data Types: `double`

ecef2ref — Orientation of reference frame with respect to ECEF frame*K*-element quaternion column vector | 3-by-3-by-*M* real array

Orientation of the reference frame with respect to the ECEF (Earth-Centered-Earth-Fixed) frame, returned as a *K*-by-1 quaternion column vector or as a 3-by-3-by-*K* real array, in which each 3-by-3 matrix is a rotation matrix.

Each quaternion or 3-by-3 rotation matrix is a frame rotation from the ECEF frame to the local reference frame (NED or ENU) at the current trajectory position.

K is the number of `SampleTimes`.

Data Types: `double`

Extended Capabilities**C/C++ Code Generation**

Generate C and C++ code using MATLAB® Coder™.

See Also

`geoTrajectory`

Introduced in R2018b

kinematicTrajectory

Rate-driven trajectory generator

Description

The `kinematicTrajectory` System object generates trajectories using specified acceleration and angular velocity.

To generate a trajectory from rates:

- 1 Create the `kinematicTrajectory` object and set its properties.
- 2 Call the object with arguments, as if it were a function.

To learn more about how System objects work, see [What Are System Objects?](#).

Creation

Syntax

```
trajectory = kinematicTrajectory  
trajectory = kinematicTrajectory(Name,Value)
```

Description

`trajectory = kinematicTrajectory` returns a System object, `trajectory`, that generates a trajectory based on acceleration and angular velocity.

`trajectory = kinematicTrajectory(Name,Value)` sets each property `Name` to the specified `Value`. Unspecified properties have default values.

Example: `trajectory = kinematicTrajectory('SampleRate',200,'Position',[0,1,10])` creates a kinematic trajectory System object, `trajectory`, with a sample rate of 200 Hz and the initial position set to `[0,1,10]`.

Properties

If a property is *tunable*, you can change its value at any time.

SampleRate — Sample rate of trajectory (Hz)

100 (default) | positive scalar

Sample rate of trajectory in Hz, specified as a positive scalar.

Tunable: Yes

Data Types: `single` | `double`

Position — Position state in local navigation coordinate system (m)

`[0 0 0]` (default) | 3-element row vector

Position state in the local navigation coordinate system in meters, specified as a three-element row vector.

Tunable: Yes

Data Types: `single` | `double`

Velocity — Velocity state in local navigation coordinate system (m/s)

`[0 0 0]` (default) | 3-element row vector

Velocity state in the local navigation coordinate system in m/s, specified as a three-element row vector.

Tunable: Yes

Data Types: `single` | `double`

Orientation — Orientation state in local navigation coordinate system

`quaternion(1,0,0,0)` (default) | scalar quaternion | 3-by-3 real matrix

Orientation state in the local navigation coordinate system, specified as a scalar quaternion or 3-by-3 real matrix. The orientation is a frame rotation from the local navigation coordinate system to the current body frame.

Tunable: Yes

Data Types: `quaternion` | `single` | `double`

AccelerationSource — Source of acceleration state

`'Input'` (default) | `'Property'`

Source of acceleration state, specified as `'Input'` or `'Property'`.

- `'Input'` -- specify acceleration state as an input argument to the kinematic trajectory object
- `'Property'` -- specify acceleration state by setting the `Acceleration` property

Tunable: No

Data Types: `char` | `string`

Acceleration — Acceleration state (m/s²)

`[0 0 0]` (default) | three-element row vector

Acceleration state in m/s², specified as a three-element row vector.

Tunable: Yes

Dependencies

To enable this property, set `AccelerationSource` to `'Property'`.

Data Types: `single` | `double`

AngularVelocitySource — Source of angular velocity state

`'Input'` (default) | `'Property'`

Source of angular velocity state, specified as `'Input'` or `'Property'`.

- 'Input' -- specify angular velocity state as an input argument to the kinematic trajectory object
- 'Property' -- specify angular velocity state by setting the AngularVelocity property

Tunable: No

Data Types: char | string

AngularVelocity — Angular velocity state (rad/s)

[0 0 0] (default) | three-element row vector

Angular velocity state in rad/s, specified as a three-element row vector.

Tunable: Yes

Dependencies

To enable this property, set AngularVelocitySource to 'Property'.

Data Types: single | double

SamplesPerFrame — Number of samples per output frame

1 (default) | positive integer

Number of samples per output frame, specified as a positive integer.

Tunable: No

Dependencies

To enable this property, set AngularVelocitySource to 'Property' and AccelerationSource to 'Property'.

Data Types: single | double

Usage

Syntax

```
[position,orientation,velocity,acceleration,angularVelocity] = trajectory(  
bodyAcceleration,bodyAngularVelocity)  
[position,orientation,velocity,acceleration,angularVelocity] = trajectory(  
bodyAngularVelocity)  
[position,orientation,velocity,acceleration,angularVelocity] = trajectory(  
bodyAcceleration)  
[position,orientation,velocity,acceleration,angularVelocity] = trajectory()
```

Description

[position,orientation,velocity,acceleration,angularVelocity] = trajectory(bodyAcceleration,bodyAngularVelocity) outputs the trajectory state and then updates the trajectory state based on bodyAcceleration and bodyAngularVelocity.

This syntax is only valid if AngularVelocitySource is set to 'Input' and AccelerationSource is set to 'Input'.

`[position,orientation,velocity,acceleration,angularVelocity] = trajectory(bodyAngularVelocity)` outputs the trajectory state and then updates the trajectory state based on `bodyAngularAcceleration`.

This syntax is only valid if `AngularVelocitySource` is set to 'Input' and `AccelerationSource` is set to 'Property'.

`[position,orientation,velocity,acceleration,angularVelocity] = trajectory(bodyAcceleration)` outputs the trajectory state and then updates the trajectory state based on `bodyAcceleration`.

This syntax is only valid if `AngularVelocitySource` is set to 'Property' and `AccelerationSource` is set to 'Input'.

`[position,orientation,velocity,acceleration,angularVelocity] = trajectory()` outputs the trajectory state and then updates the trajectory state.

This syntax is only valid if `AngularVelocitySource` is set to 'Property' and `AccelerationSource` is set to 'Property'.

Input Arguments

bodyAcceleration — Acceleration in body coordinate system (m/s²)

N-by-3 matrix

Acceleration in the body coordinate system in meters per second squared, specified as an *N*-by-3 matrix.

N is the number of samples in the current frame.

bodyAngularVelocity — Angular velocity in body coordinate system (rad/s)

N-by-3 matrix

Angular velocity in the body coordinate system in radians per second, specified as an *N*-by-3 matrix.

N is the number of samples in the current frame.

Output Arguments

position — Position in local navigation coordinate system (m)

N-by-3 matrix

Position in the local navigation coordinate system in meters, returned as an *N*-by-3 matrix.

N is the number of samples in the current frame.

Data Types: `single` | `double`

orientation — Orientation in local navigation coordinate system

N-element quaternion column vector | 3-by-3-by-*N* real array

Orientation in the local navigation coordinate system, returned as an *N*-by-1 quaternion column vector or a 3-by-3-by-*N* real array. Each quaternion or 3-by-3 rotation matrix is a frame rotation from the local navigation coordinate system to the current body coordinate system.

N is the number of samples in the current frame.

Data Types: `single` | `double`

velocity — Velocity in local navigation coordinate system (m/s)

N-by-3 matrix

Velocity in the local navigation coordinate system in meters per second, returned as an *N*-by-3 matrix.

N is the number of samples in the current frame.

Data Types: `single` | `double`

acceleration — Acceleration in local navigation coordinate system (m/s²)

N-by-3 matrix

Acceleration in the local navigation coordinate system in meters per second squared, returned as an *N*-by-3 matrix.

N is the number of samples in the current frame.

Data Types: `single` | `double`

angularVelocity — Angular velocity in local navigation coordinate system (rad/s)

N-by-3 matrix

Angular velocity in the local navigation coordinate system in radians per second, returned as an *N*-by-3 matrix.

N is the number of samples in the current frame.

Data Types: `single` | `double`

Object Functions

Specific to `kinematicTrajectory`

`perturbations` Perturbation defined on object
`perturb` Apply perturbations to object

Common to All System Objects

`step` Run System object algorithm

Examples

Create Default `kinematicTrajectory`

Create a default `kinematicTrajectory` System object™ and explore the relationship between input, properties, and the generated trajectories.

```
trajectory = kinematicTrajectory
```

```
trajectory =  
    kinematicTrajectory with properties:
```

```
        SampleRate: 100
```



```

        Position: [0 0 0]
        Orientation: [1x1 quaternion]
        Velocity: [0 0 0]
        AccelerationSource: 'Input'
        AngularVelocitySource: 'Input'

```

By default, the `kinematicTrajectory` object has an initial position of $[0\ 0\ 0]$ and an initial velocity of $[0\ 0\ 0]$. Orientation is described by a quaternion one $(1 + 0i + 0j + 0k)$.

The `kinematicTrajectory` object maintains a visible and writable state in the properties `Position`, `Velocity`, and `Orientation`. When you call the object, the state is output and then updated.

For example, call the object by specifying an acceleration and angular velocity relative to the body coordinate system.

```

bodyAcceleration = [5,5,0];
bodyAngularVelocity = [0,0,1];
[position,orientation,velocity,acceleration,angularVelocity] = trajectory(bodyAcceleration,bodyAngularVelocity)

```

```
position = 1x3
```

```
    0    0    0
```

```
orientation = quaternion
```

```
    1 + 0i + 0j + 0k
```

```
velocity = 1x3
```

```
    0    0    0
```

```
acceleration = 1x3
```

```
    5    5    0
```

```
angularVelocity = 1x3
```

```
    0    0    1
```

The position, orientation, and velocity output from the `trajectory` object correspond to the state reported by the properties before calling the object. The `trajectory` state is updated after being called and is observable from the properties:

```
trajectory
```

```
trajectory =
```

```
    kinematicTrajectory with properties:
```

```

        SampleRate: 100
        Position: [2.5000e-04 2.5000e-04 0]
        Orientation: [1x1 quaternion]
        Velocity: [0.0500 0.0500 0]
        AccelerationSource: 'Input'

```

```
AngularVelocitySource: 'Input'
```

The acceleration and angularVelocity output from the trajectory object correspond to the bodyAcceleration and bodyAngularVelocity, except that they are returned in the navigation coordinate system. Use the orientation output to rotate acceleration and angularVelocity to the body coordinate system and verify they are approximately equivalent to bodyAcceleration and bodyAngularVelocity.

```
rotatedAcceleration = rotatepoint(orientation,acceleration)
```

```
rotatedAcceleration = 1×3
```

```
5    5    0
```

```
rotatedAngularVelocity = rotatepoint(orientation,angularVelocity)
```

```
rotatedAngularVelocity = 1×3
```

```
0    0    1
```

The kinematicTrajectory System object™ enables you to modify the trajectory state through the properties. Set the position to [0,0,0] and then call the object with a specified acceleration and angular velocity in the body coordinate system. For illustrative purposes, clone the trajectory object before modifying the Position property. Call both objects and observe that the positions diverge.

```
trajectoryClone = clone(trajectory);  
trajectory.Position = [0,0,0];
```

```
position = trajectory(bodyAcceleration,bodyAngularVelocity)
```

```
position = 1×3
```

```
0    0    0
```

```
clonePosition = trajectoryClone(bodyAcceleration,bodyAngularVelocity)
```

```
clonePosition = 1×3
```

```
10-3 ×
```

```
0.2500    0.2500    0
```

Create Oscillating Trajectory

This example shows how to create a trajectory oscillating along the North axis of a local NED coordinate system using the kinematicTrajectory System object™.

Create a default kinematicTrajectory object. The default initial orientation is aligned with the local NED coordinate system.

```
traj = kinematicTrajectory
```

```

traj =
    kinematicTrajectory with properties:
        SampleRate: 100
        Position: [0 0 0]
        Orientation: [1x1 quaternion]
        Velocity: [0 0 0]
        AccelerationSource: 'Input'
        AngularVelocitySource: 'Input'

```

Define a trajectory for a duration of 10 seconds consisting of rotation around the East axis (pitch) and an oscillation along North axis of the local NED coordinate system. Use the default `kinematicTrajectory` sample rate.

```

fs = traj.SampleRate;
duration = 10;

numSamples = duration*fs;

cyclesPerSecond = 1;
samplesPerCycle = fs/cyclesPerSecond;
numCycles = ceil(numSamples/samplesPerCycle);
maxAccel = 20;

triangle = [linspace(maxAccel,1/fs-maxAccel,samplesPerCycle/2), ...
            linspace(-maxAccel,maxAccel-(1/fs),samplesPerCycle/2)'];
oscillation = repmat(triangle,numCycles,1);
oscillation = oscillation(1:numSamples);

accNED = [zeros(numSamples,2),oscillation];

angVelNED = zeros(numSamples,3);
angVelNED(:,2) = 2*pi;

Plot the acceleration control signal.

timeVector = 0:1/fs:(duration-1/fs);

figure(1)
plot(timeVector,oscillation)
xlabel('Time (s)')
ylabel('Acceleration (m/s)^2')
title('Acceleration in Local NED Coordinate System')

```

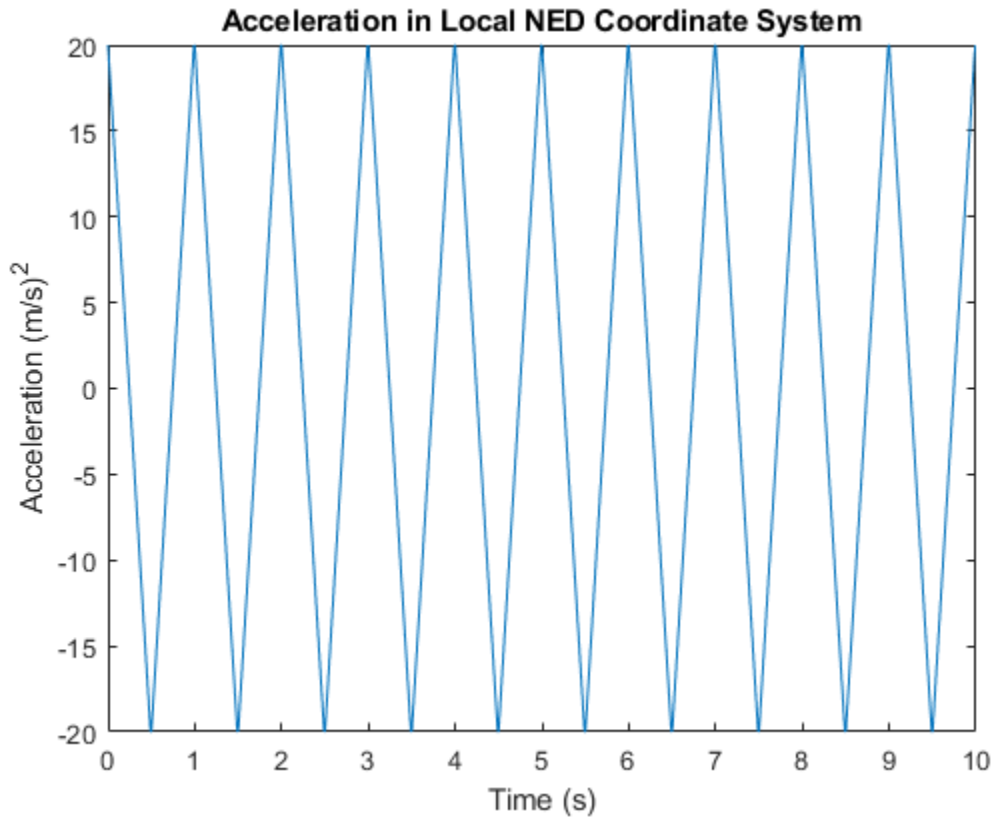

Generate the trajectory sample-by-sample in a loop. The `kinematicTrajectory` System object assumes the acceleration and angular velocity inputs are in the local sensor body coordinate system. Rotate the acceleration and angular velocity control signals from the NED coordinate system to the sensor body coordinate system using `rotateframe` and the `Orientation` state. Update a 3-D plot of the position at each time. Add `pause` to mimic real-time processing. Once the loop is complete, plot the position over time. Rotating the `accNED` and `angVelNED` control signals to the local body coordinate system assures the motion stays along the Down axis.

```
figure(2)
plotHandle = plot3(traj.Position(1),traj.Position(2),traj.Position(3),'bo');
grid on
xlabel('North')
ylabel('East')
zlabel('Down')
axis([-1 1 -1 1 0 1.5])
hold on

q = ones(numSamples,1,'quaternion');
for ii = 1:numSamples
    accBody = rotateframe(traj.Orientation,accNED(ii,:));
    angVelBody = rotateframe(traj.Orientation,angVelNED(ii,:));

    [pos(ii,:),q(ii),vel,ac] = traj(accBody,angVelBody);

    set(plotHandle,'XData',pos(ii,1),'YData',pos(ii,2),'ZData',pos(ii,3))

    pause(1/fs)
```

```
end  
  
figure(3)  
plot(timeVector,pos(:,1),'bo',...  
      timeVector,pos(:,2),'r.',...  
      timeVector,pos(:,3),'g.')  
xlabel('Time (s)')  
ylabel('Position (m)')  
title('NED Position Over Time')  
legend('North','East','Down')
```

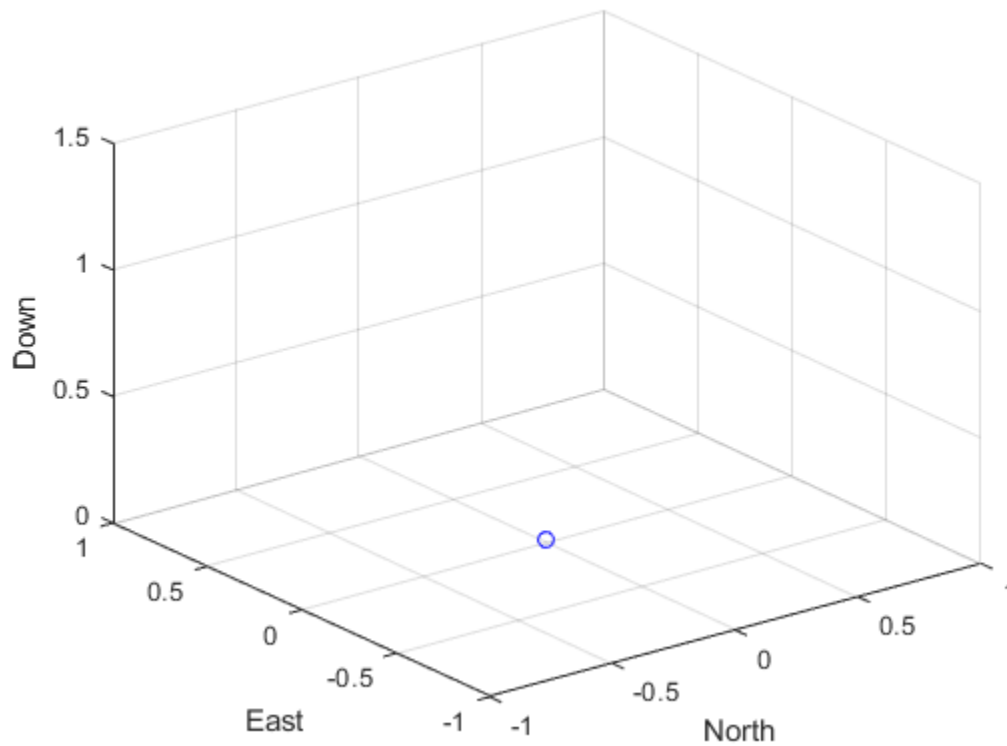

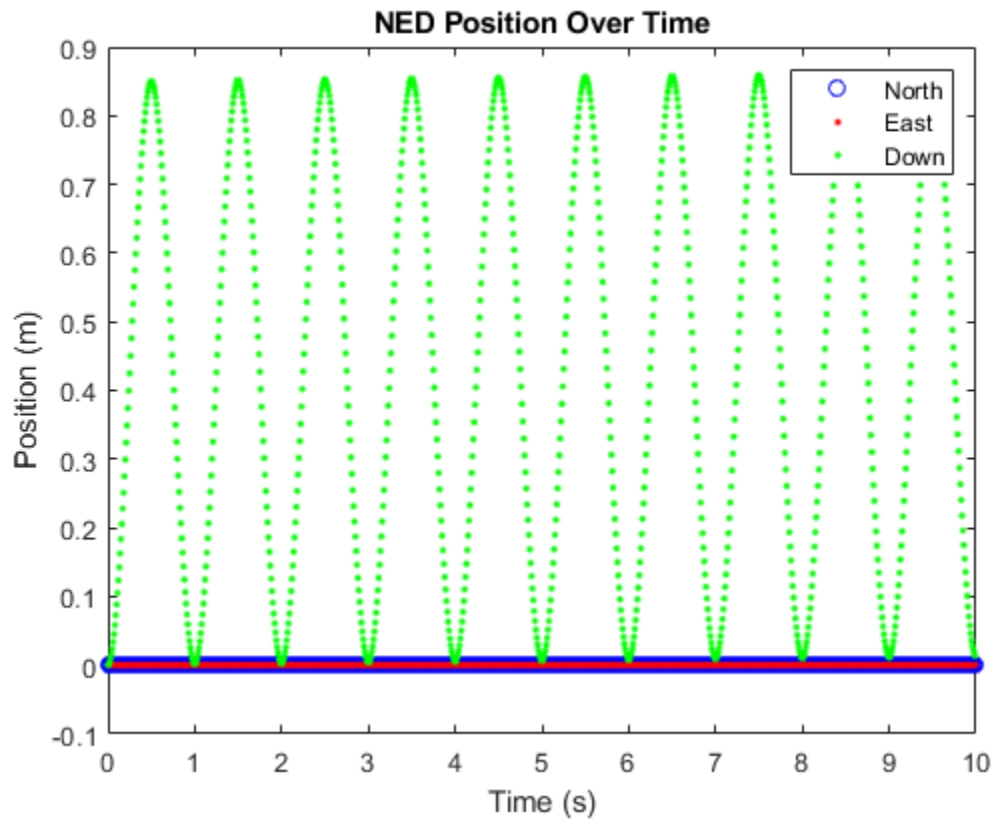

Convert the recorded orientation to Euler angles and plot. Although the orientation of the platform changed over time, the acceleration always acted along the North axis.

```
figure(4)
eulerAngles = eulerd(q, 'ZYX', 'frame');
plot(timeVector, eulerAngles(:,1), 'bo', ...
      timeVector, eulerAngles(:,2), 'r.', ...
      timeVector, eulerAngles(:,3), 'g.')
axis([0, duration, -180, 180])
legend('Yaw', 'Pitch', 'Roll')
xlabel('Time (s)')
ylabel('Rotation (degrees)')
title('Orientation')
```

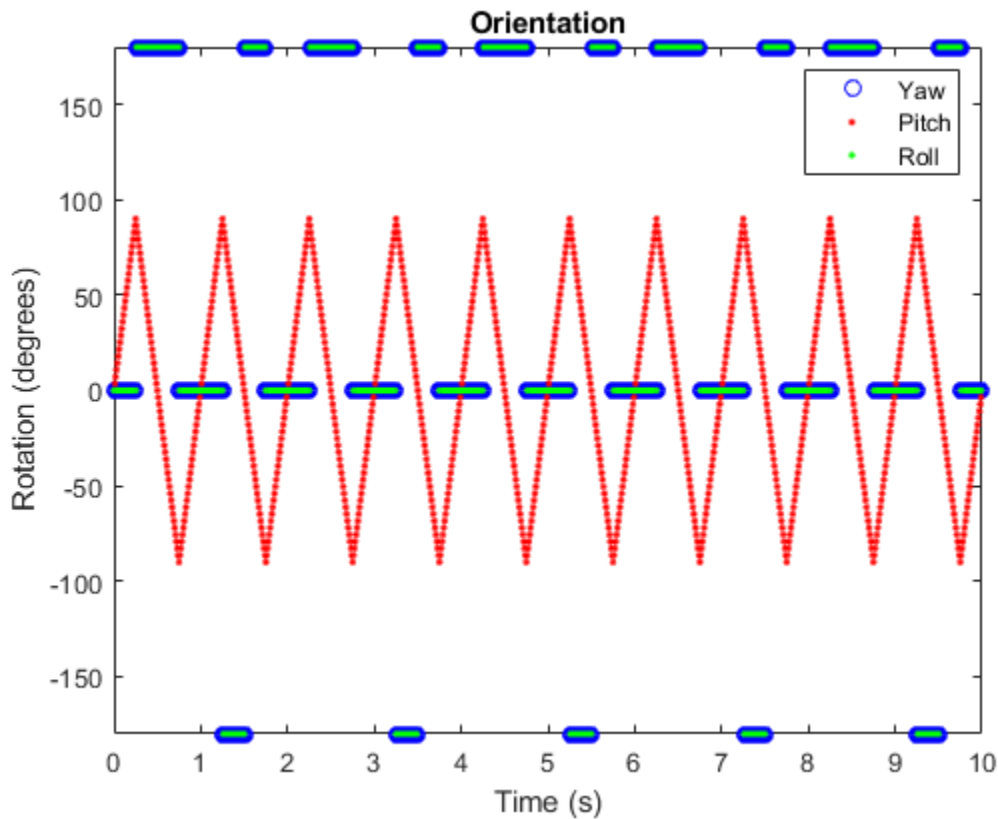

Generate a Coil Trajectory

This example shows how to generate a coil trajectory using the kinematicTrajectory System object™.

Create a circular trajectory for a 1000 second duration and a sample rate of 10 Hz. Set the radius of the circle to 5000 meters and the speed to 80 meters per second. Set the climb rate to 100 meters per second and the pitch to 15 degrees. Specify the initial orientation as pointed in the direction of motion.

```
duration = 1000; % seconds
fs = 10; % Hz
N = duration*fs; % number of samples

radius = 5000; % meters
speed = 80; % meters per second
climbRate = 50; % meters per second
initialYaw = 90; % degrees
pitch = 15; % degrees

initPos = [radius, 0, 0];
initVel = [0, speed, climbRate];
initOrientation = quaternion([initialYaw,pitch,0], 'eulerd', 'zyx', 'frame');

trajectory = kinematicTrajectory('SampleRate',fs, ...
```

```
'Velocity',initVel, ...  
'Position',initPos, ...  
'Orientation',initOrientation);
```

Specify a constant acceleration and angular velocity in the body coordinate system. Rotate the body frame to account for the pitch.

```
accBody = zeros(N,3);  
accBody(:,2) = speed^2/radius;  
accBody(:,3) = 0.2;
```

```
angVelBody = zeros(N,3);  
angVelBody(:,3) = speed/radius;
```

```
pitchRotation = quaternion([0,pitch,0], 'eulerd', 'zyx', 'frame');  
angVelBody = rotateframe(pitchRotation,angVelBody);  
accBody = rotateframe(pitchRotation,accBody);
```

Call `trajectory` with the specified acceleration and angular velocity in the body coordinate system. Plot the position, orientation, and speed over time.

```
[position, orientation, velocity] = trajectory(accBody,angVelBody);
```

```
eulerAngles = eulerd(orientation, 'ZYX', 'frame');  
speed = sqrt(sum(velocity.^2,2));
```

```
timeVector = (0:(N-1))/fs;
```

```
figure(1)  
plot3(position(:,1),position(:,2),position(:,3))  
xlabel('North (m)')  
ylabel('East (m)')  
zlabel('Down (m)')  
title('Position')  
grid on
```

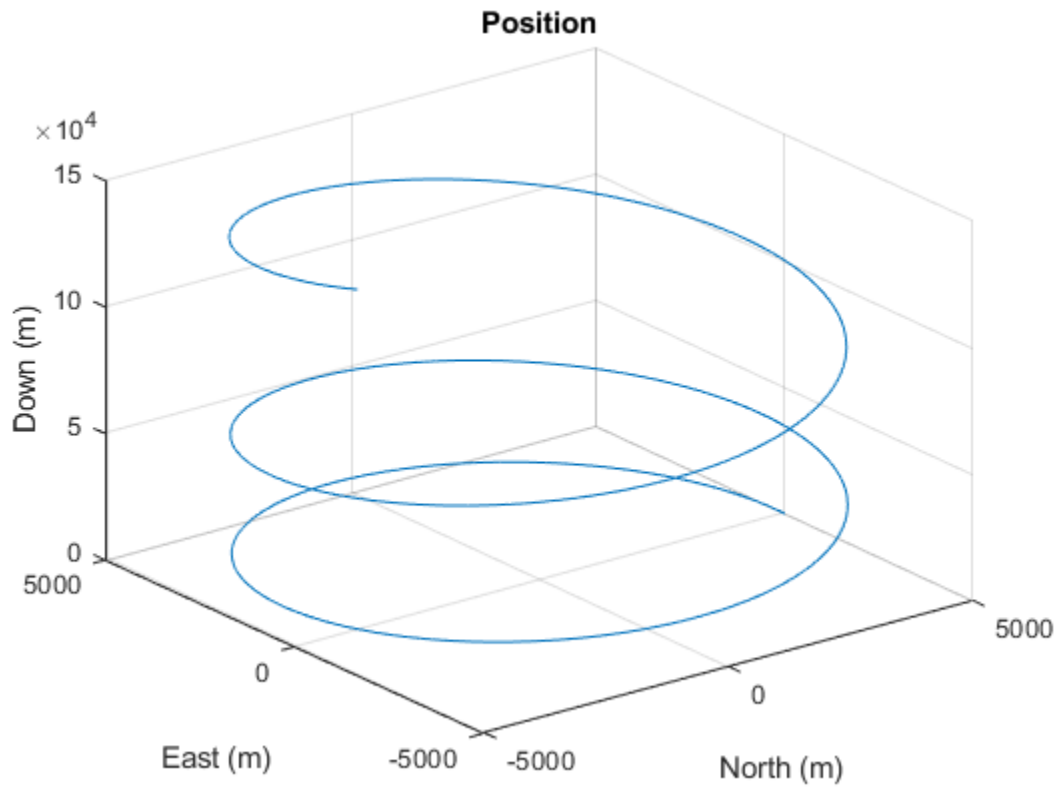
```

figure(2)
plot(timeVector,eulerAngles(:,1),...
      timeVector,eulerAngles(:,2),...
      timeVector,eulerAngles(:,3))
axis([0,duration,-180,180])
legend('Yaw (Rotation Around Down)', 'Pitch (Rotation Around East)', 'Roll (Rotation Around North)')
xlabel('Time (s)')
ylabel('Rotation (degrees)')
title('Orientation')

```

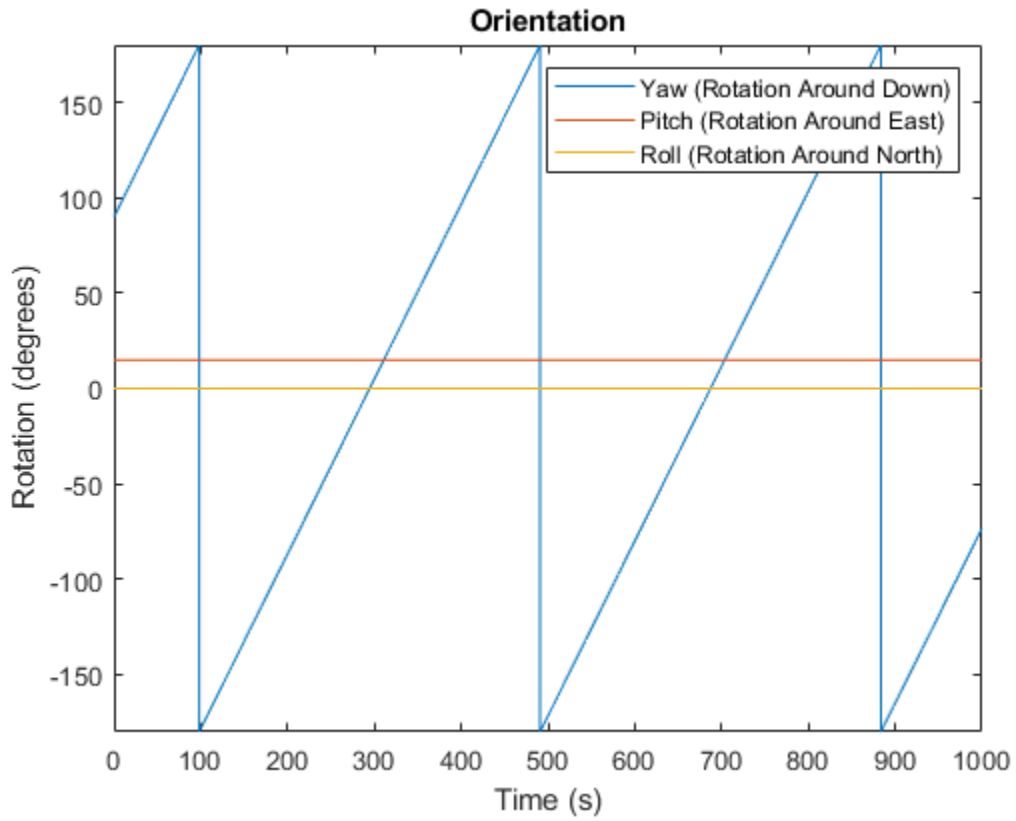

```
figure(3)
plot(timeVector,speed)
xlabel('Time (s)')
ylabel('Speed (m/s)')
title('Speed')
```

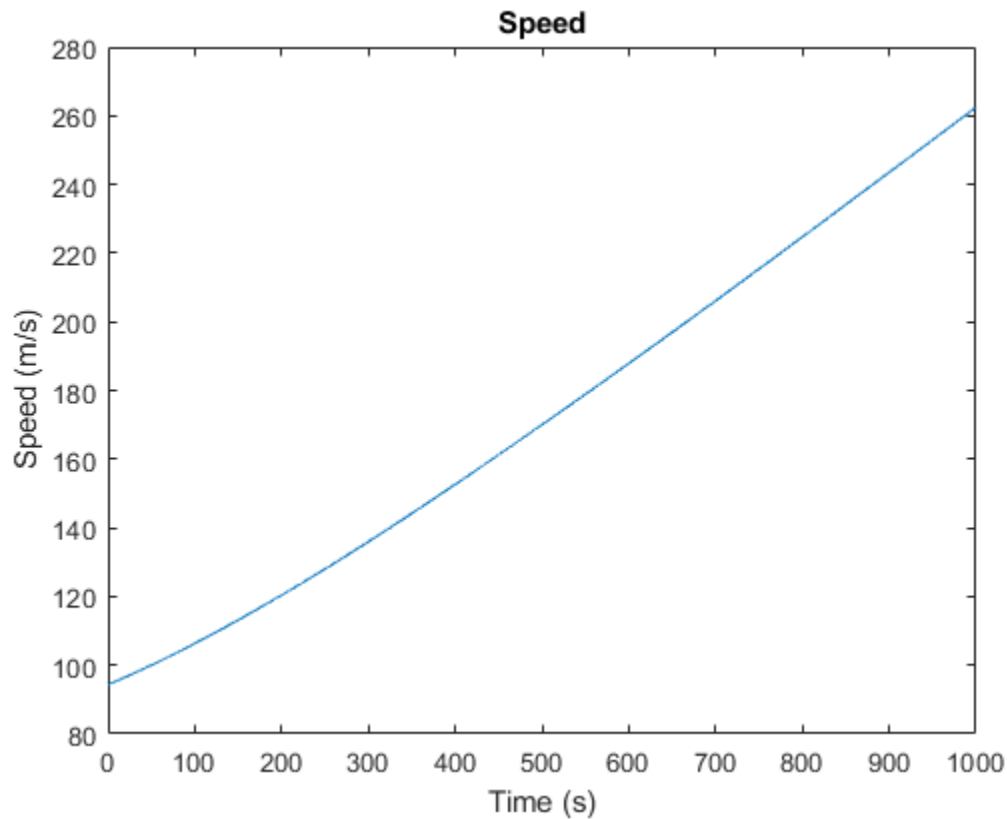

Generate Spiraling Circular Trajectory with No Inputs

Define a constant angular velocity and constant acceleration that describe a spiraling circular trajectory.

```
Fs = 100;
r = 10;
speed = 2.5;
initialYaw = 90;
```

```
initPos = [r 0 0];
initVel = [0 speed 0];
initOrient = quaternion([initialYaw 0 0], 'eulerd', 'ZYX', 'frame');
```

```
accBody = [0 speed^2/r 0.01];
angVelBody = [0 0 speed/r];
```

Create a kinematic trajectory object.

```
traj = kinematicTrajectory('SampleRate',Fs, ...
    'Position',initPos, ...
    'Velocity',initVel, ...
    'Orientation',initOrient, ...
    'AccelerationSource','Property', ...
    'Acceleration',accBody, ...
```

```
'AngularVelocitySource','Property', ...  
'AngularVelocity',angVelBody);
```

Call the kinematic trajectory object in a loop and log the position output. Plot the position over time.

```
N = 10000;  
pos = zeros(N, 3);  
for i = 1:N  
    pos(i,:) = traj();  
end  
  
plot3(pos(:,1), pos(:,2), pos(:,3))  
title('Position')  
xlabel('X (m)')  
ylabel('Y (m)')  
zlabel('Z (m)')
```

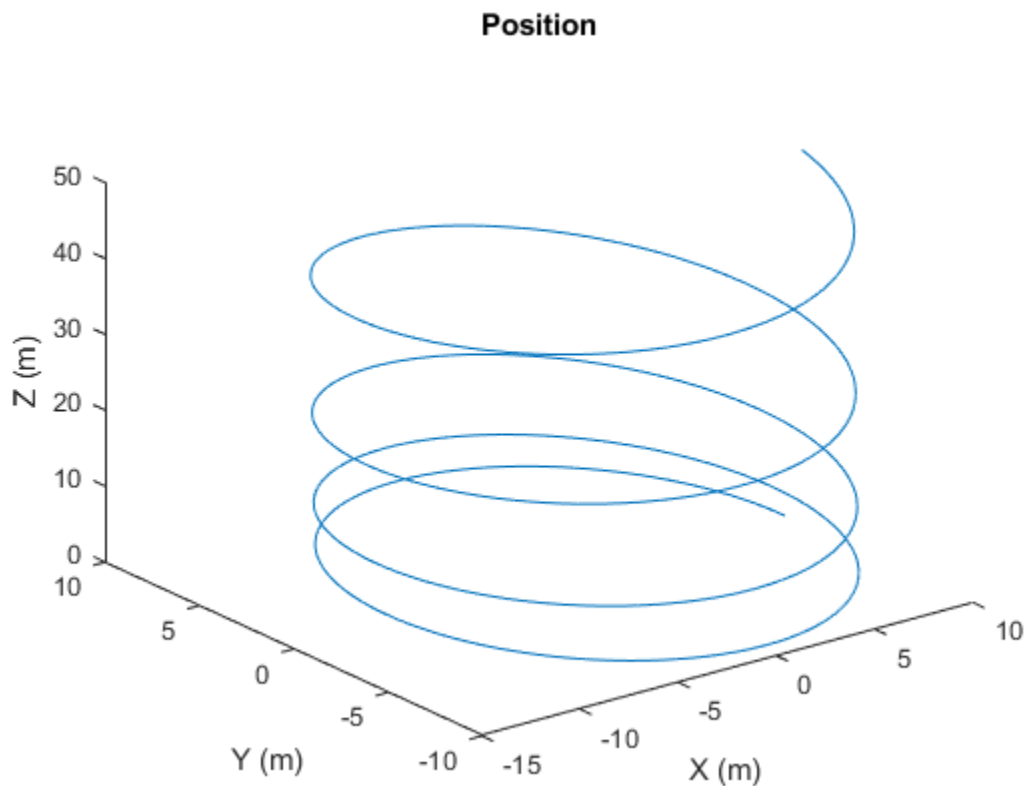

Extended Capabilities

C/C++ Code Generation

Generate C and C++ code using MATLAB® Coder™.

Usage notes and limitations:

“System Objects in MATLAB Code Generation” (MATLAB Coder)

See Also

platform | trackingScenario | waypointTrajectory

Introduced in R2018b

waypointTrajectory

Waypoint trajectory generator

Description

The `waypointTrajectory` System object generates trajectories using specified waypoints. When you create the System object, you can optionally specify the time of arrival, velocity, and orientation at each waypoint. See “Algorithms” on page 3-247 for more details.

To generate a trajectory from waypoints:

- 1 Create the `waypointTrajectory` object and set its properties.
- 2 Call the object as if it were a function.

To learn more about how System objects work, see [What Are System Objects?](#)

Creation

Syntax

```
trajectory = waypointTrajectory
trajectory = waypointTrajectory(Waypoints,TimeOfArrival)
trajectory = waypointTrajectory(Waypoints,TimeOfArrival,Name,Value)
```

Description

`trajectory = waypointTrajectory` returns a System object, `trajectory`, that generates a trajectory based on default stationary waypoints.

`trajectory = waypointTrajectory(Waypoints,TimeOfArrival)` specifies the `Waypoints` that the generated trajectory passes through and the `TimeOfArrival` at each waypoint.

`trajectory = waypointTrajectory(Waypoints,TimeOfArrival,Name,Value)` sets each creation argument or property `Name` to the specified `Value`. Unspecified properties and creation arguments have default or inferred values.

Example: `trajectory = waypointTrajectory([10,10,0;20,20,0;20,20,10],[0,0.5,10])` creates a waypoint trajectory System object, `trajectory`, that starts at waypoint `[10,10,0]`, and then passes through `[20,20,0]` after 0.5 seconds and `[20,20,10]` after 10 seconds.

Creation Arguments

Creation arguments are properties which are set during creation of the System object and cannot be modified later. If you do not explicitly set a creation argument value, the property value is inferred.

If you specify any creation argument, then you must specify both the `Waypoints` and `TimeOfArrival` creation arguments. You can specify `Waypoints` and `TimeOfArrival` as value-only arguments or name-value pairs.

Properties

Unless otherwise indicated, properties are *nontunable*, which means you cannot change their values after calling the object. Objects lock when you call them, and the `release` function unlocks them.

If a property is *tunable*, you can change its value at any time.

For more information on changing property values, see System Design in MATLAB Using System Objects.

SampleRate — Sample rate of trajectory (Hz)

100 (default) | positive scalar

Sample rate of trajectory in Hz, specified as a positive scalar.

Tunable: Yes

Data Types: double

SamplesPerFrame — Number of samples per output frame

1 (default) | positive scalar integer

Number of samples per output frame, specified as a positive scalar integer.

Tunable: Yes

Data Types: double

Waypoints — Positions in the navigation coordinate system (m)

N -by-3 matrix

Positions in the navigation coordinate system in meters, specified as an N -by-3 matrix. The columns of the matrix correspond to the first, second, and third axes, respectively. The rows of the matrix, N , correspond to individual waypoints.

Dependencies

To set this property, you must also set valid values for the `TimeOfArrival` property.

Data Types: double

TimeOfArrival — Time at each waypoint (s)

N -element column vector of nonnegative increasing numbers

Time corresponding to arrival at each waypoint in seconds, specified as an N -element column vector. The first element of `TimeOfArrival` must be 0. The number of samples, N , must be the same as the number of samples (rows) defined by `Waypoints`.

Dependencies

To set this property, you must also set valid values for the `Waypoints` property.

Data Types: double

Velocities — Velocity in navigation coordinate system at each waypoint (m/s)

N -by-3 matrix

Velocity in the navigation coordinate system at each way point in meters per second, specified as an N -by-3 matrix. The columns of the matrix correspond to the first, second, and third axes, respectively.

The number of samples, N , must be the same as the number of samples (rows) defined by `Waypoints`.

If the velocity is specified as a non-zero value, the object automatically calculates the course of the trajectory. If the velocity is specified as zero, the object infers the course of the trajectory from adjacent waypoints.

Dependencies

To set this property, you must also set valid values for the `Waypoints` and `TimeOfArrival` properties.

Data Types: `double`

Course — Horizontal direction of travel (degree)

N -element real vector

Horizontal direction of travel, specified as an N -element real vector in degrees. The number of samples, N , must be the same as the number of samples (rows) defined by `Waypoints`. If neither `Velocities` nor `Course` is specified, course is inferred from the waypoints.

Dependencies

To set this property, the `Velocities` property must not be specified in object creation.

Data Types: `double`

GroundSpeed — Groundspeed at each waypoint (m/s)

N -element real vector

Groundspeed at each waypoint, specified as an N -element real vector in m/s. If the property is not specified, it is inferred from the waypoints. The number of samples, N , must be the same as the number of samples (rows) defined by `Waypoints`.

Dependencies

To set this property, the `Velocities` property must not be specified at object creation.

Data Types: `double`

ClimbRate — Climb rate at each waypoint (m/s)

N -element real vector

Climb Rate at each waypoint, specified as an N -element real vector in degrees. The number of samples, N , must be the same as the number of samples (rows) defined by `Waypoints`. If neither `Velocities` nor `Course` is specified, `climbrate` is inferred from the waypoints.

Dependencies

To set this property, the `Velocities` property must not be specified at object creation.

Data Types: `double`

Orientation — Orientation at each waypoint

N -element quaternion column vector | 3-by-3-by- N array of real numbers

Orientation at each waypoint, specified as an N -element quaternion column vector or 3-by-3-by- N array of real numbers. The number of quaternions or rotation matrices, N , must be the same as the number of samples (rows) defined by `Waypoints`.

If `Orientation` is specified by quaternions, the underlying class must be `double`.

Dependencies

To set this property, you must also set valid values for the `Waypoints` and `TimeOfArrival` properties.

Data Types: `quaternion` | `double`

AutoPitch — Align pitch angle with direction of motion

`false` (default) | `true`

Align pitch angle with the direction of motion, specified as `true` or `false`. When specified as `true`, the pitch angle automatically aligns with the direction of motion. If specified as `false`, the pitch angle is set to zero (level orientation).

Dependencies

To set this property, the `Orientation` property must not be specified at object creation.

AutoBank — Align roll angle to counteract centripetal force

`false` (default) | `true`

Align roll angle to counteract the centripetal force, specified as `true` or `false`. When specified as `true`, the roll angle automatically counteract the centripetal force. If specified as `false`, the roll angle is set to zero (flat orientation).

Dependencies

To set this property, the `Orientation` property must not be specified at object creation.

ReferenceFrame — Reference frame of trajectory

`'NED'` (default) | `'ENU'`

Reference frame of the trajectory, specified as `'NED'` (North-East-Down) or `'ENU'` (East-North-Up).

Usage

Syntax

```
[position,orientation,velocity,acceleration,angularVelocity] = trajectory()
```

Description

`[position,orientation,velocity,acceleration,angularVelocity] = trajectory()` outputs a frame of trajectory data based on specified creation arguments and properties.

Output Arguments

position — Position in local navigation coordinate system (m)

M-by-3 matrix

Position in the local navigation coordinate system in meters, returned as an *M*-by-3 matrix.

M is specified by the `SamplesPerFrame` property.

Data Types: `double`

orientation — Orientation in local navigation coordinate system

M-element quaternion column vector | 3-by-3-by-*M* real array

Orientation in the local navigation coordinate system, returned as an *M*-by-1 quaternion column vector or a 3-by-3-by-*M* real array.

Each quaternion or 3-by-3 rotation matrix is a frame rotation from the local navigation coordinate system to the current body coordinate system.

M is specified by the SamplesPerFrame property.

Data Types: double

velocity — Velocity in local navigation coordinate system (m/s)

M-by-3 matrix

Velocity in the local navigation coordinate system in meters per second, returned as an *M*-by-3 matrix.

M is specified by the SamplesPerFrame property.

Data Types: double

acceleration — Acceleration in local navigation coordinate system (m/s²)

M-by-3 matrix

Acceleration in the local navigation coordinate system in meters per second squared, returned as an *M*-by-3 matrix.

M is specified by the SamplesPerFrame property.

Data Types: double

angularVelocity — Angular velocity in local navigation coordinate system (rad/s)

M-by-3 matrix

Angular velocity in the local navigation coordinate system in radians per second, returned as an *M*-by-3 matrix.

M is specified by the SamplesPerFrame property.

Data Types: double

Object Functions

To use an object function, specify the System object as the first input argument. For example, to release system resources of a System object named `obj`, use this syntax:

```
release(obj)
```

Specific to waypointTrajectory

waypointInfo	Get waypoint information table
lookupPose	Obtain pose information for certain time
perturbations	Perturbation defined on object
perturb	Apply perturbations to object

Common to All System Objects

clone Create duplicate System object
 step Run System object algorithm
 release Release resources and allow changes to System object property values and input characteristics
 reset Reset internal states of System object
 isDone End-of-data status

Examples

Create Default waypointTrajectory

```
trajectory = waypointTrajectory

trajectory =
  waypointTrajectory with properties:

    SampleRate: 100
    SamplesPerFrame: 1
    Waypoints: [2x3 double]
    TimeOfArrival: [2x1 double]
    Velocities: [2x3 double]
    Course: [2x1 double]
    GroundSpeed: [2x1 double]
    ClimbRate: [2x1 double]
    Orientation: [2x1 quaternion]
    AutoPitch: 0
    AutoBank: 0
    ReferenceFrame: 'NED'
```

Inspect the default waypoints and times of arrival by calling `waypointInfo`. By default, the waypoints indicate a stationary position for one second.

```
waypointInfo(trajectory)
```

```
ans=2x2 table
   TimeOfArrival   Waypoints
   _____   _____
           0           0     0     0
           1           0     0     0
```

Create Square Trajectory

Create a square trajectory and examine the relationship between waypoint constraints, sample rate, and the generated trajectory.

Create a square trajectory by defining the vertices of the square. Define the orientation at each waypoint as pointing in the direction of motion. Specify a 1 Hz sample rate and use the default `SamplesPerFrame` of 1.

```
waypoints = [0,0,0; ... % Initial position
            0,1,0; ...
            1,1,0; ...
            1,0,0; ...
            0,0,0]; % Final position

toa = 0:4; % time of arrival

orientation = quaternion([0,0,0; ...
                        45,0,0; ...
                        135,0,0; ...
                        225,0,0; ...
                        0,0,0], ...
                        'eulerd','ZYX','frame');

trajectory = waypointTrajectory(waypoints, ...
                                'TimeOfArrival',toa, ...
                                'Orientation',orientation, ...
                                'SampleRate',1);
```

Create a figure and plot the initial position of the platform.

```
figure(1)
plot(waypoints(1,1),waypoints(1,2), 'b*')
title('Position')
axis([-1,2,-1,2])
axis square
xlabel('X')
ylabel('Y')
grid on
hold on
```

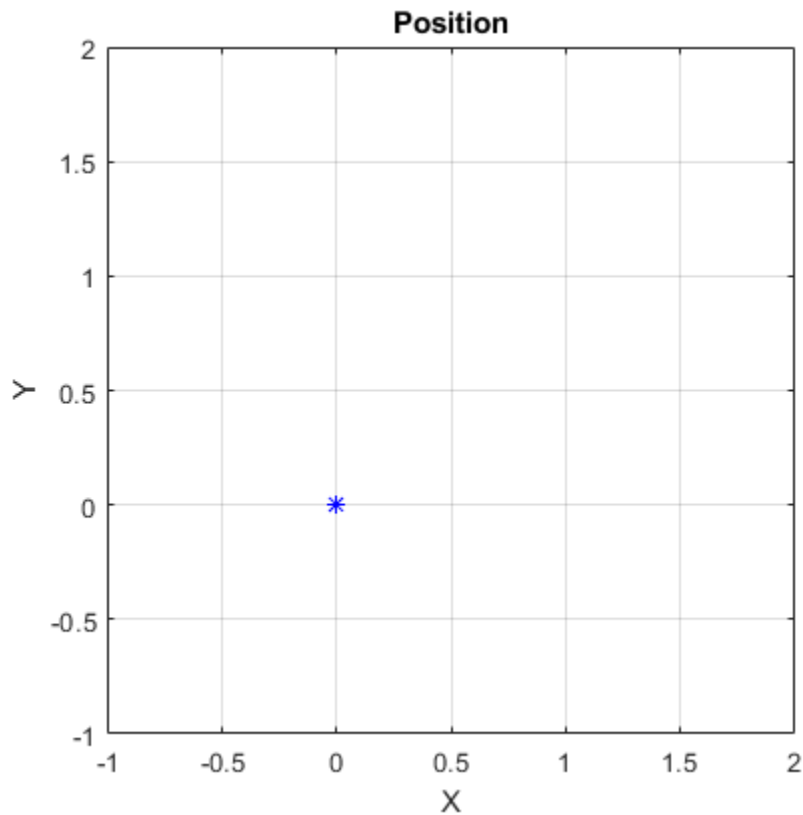

In a loop, step through the trajectory to output the current position and current orientation. Plot the current position and log the orientation. Use `pause` to mimic real-time processing.

```
orientationLog = zeros(toa(end)*trajectory.SampleRate,1,'quaternion');
count = 1;
while ~isDone(trajectory)
    [currentPosition,orientationLog(count)] = trajectory();

    plot(currentPosition(1),currentPosition(2),'bo')

    pause(trajectory.SamplesPerFrame/trajectory.SampleRate)
    count = count + 1;
end
hold off
```

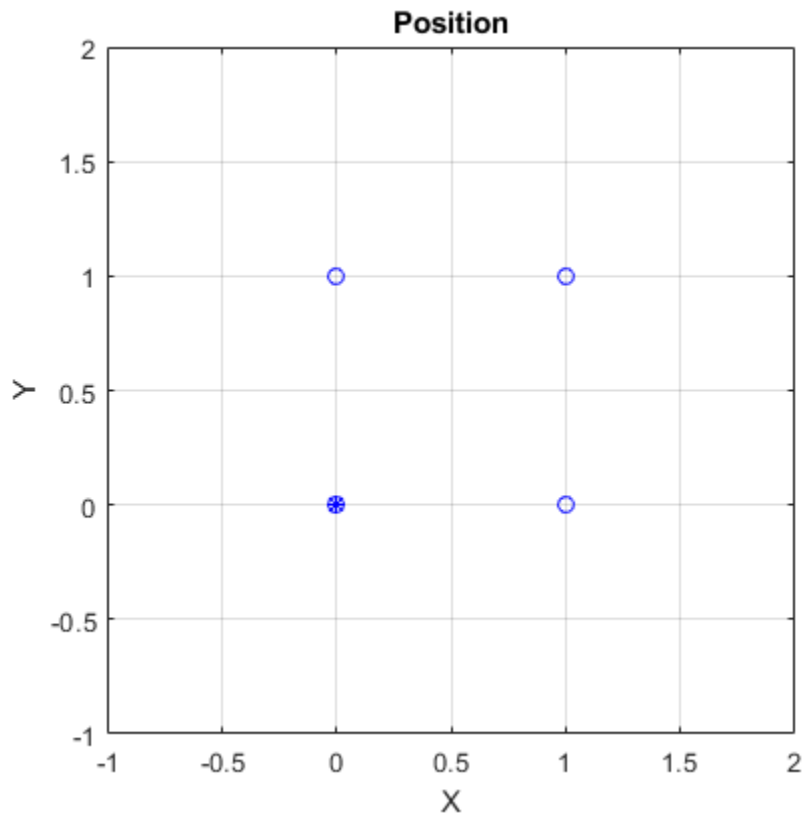

Convert the orientation quaternions to Euler angles for easy interpretation, and then plot orientation over time.

```
figure(2)
eulerAngles = eulerd([orientation(1);orientationLog], 'ZYX', 'frame');
plot(toa,eulerAngles(:,1),'ko', ...
      toa,eulerAngles(:,2),'bd', ...
      toa,eulerAngles(:,3),'r.');
```

title('Orientation Over Time')
 legend('Rotation around Z-axis','Rotation around Y-axis','Rotation around X-axis')
 xlabel('Time (seconds)')
 ylabel('Rotation (degrees)')
 grid on

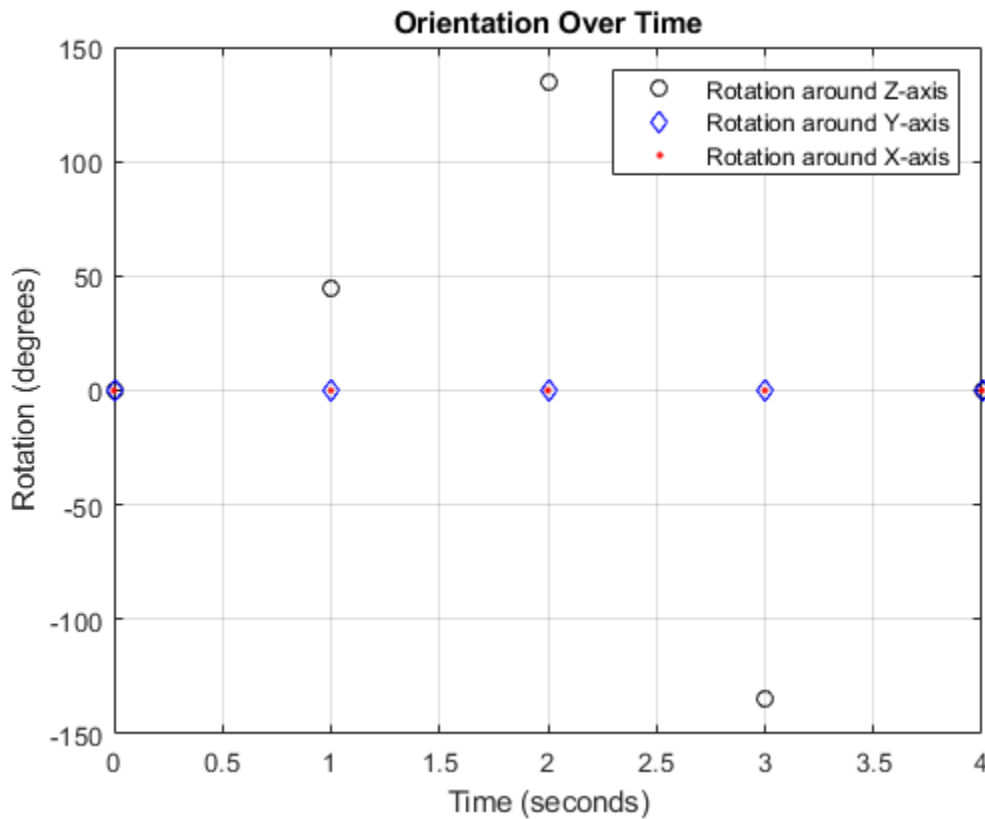

So far, the trajectory object has only output the waypoints that were specified during construction. To interpolate between waypoints, increase the sample rate to a rate faster than the time of arrivals of the waypoints. Set the trajectory sample rate to 100 Hz and call reset.

```
trajectory.SampleRate = 100;
reset(trajectory)
```

Create a figure and plot the initial position of the platform. In a loop, step through the trajectory to output the current position and current orientation. Plot the current position and log the orientation. Use pause to mimic real-time processing.

```
figure(1)
plot(waypoints(1,1),waypoints(1,2),'b*')
title('Position')
axis([-1,2,-1,2])
axis square
xlabel('X')
ylabel('Y')
grid on
hold on

orientationLog = zeros(toa(end)*trajectory.SampleRate,1,'quaternion');
count = 1;
while ~isDone(trajectory)
    [currentPosition,orientationLog(count)] = trajectory();

    plot(currentPosition(1),currentPosition(2),'bo')
```

```

    pause(trajjectory.SamplesPerFrame/trajjectory.SampleRate)
    count = count + 1;
end
hold off

```

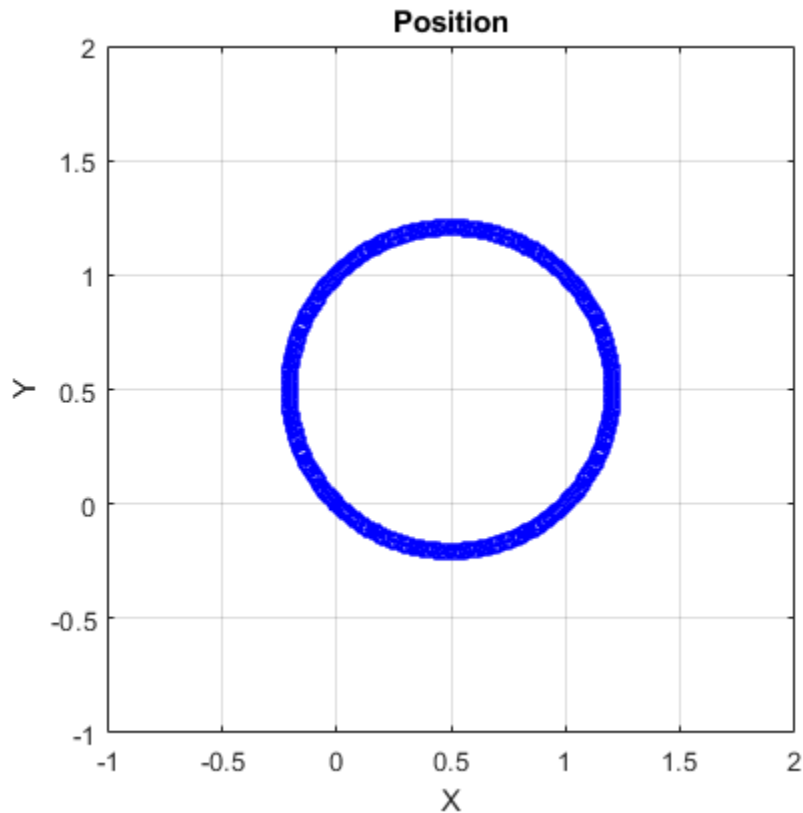

The trajectory output now appears circular. This is because the `waypointTrajectory` System object™ minimizes the acceleration and angular velocity when interpolating, which results in smoother, more realistic motions in most scenarios.

Convert the orientation quaternions to Euler angles for easy interpretation, and then plot orientation over time. The orientation is also interpolated.

```

figure(2)
eulerAngles = eulerd([orientation(1);orientationLog], 'ZYX', 'frame');
t = 0:1/trajjectory.SampleRate:4;
plot(t,eulerAngles(:,1),'ko', ...
      t,eulerAngles(:,2),'bd', ...
      t,eulerAngles(:,3),'r. ');
title('Orientation Over Time')
legend('Rotation around Z-axis', 'Rotation around Y-axis', 'Rotation around X-axis')
xlabel('Time (seconds)')
ylabel('Rotation (degrees)')
grid on

```

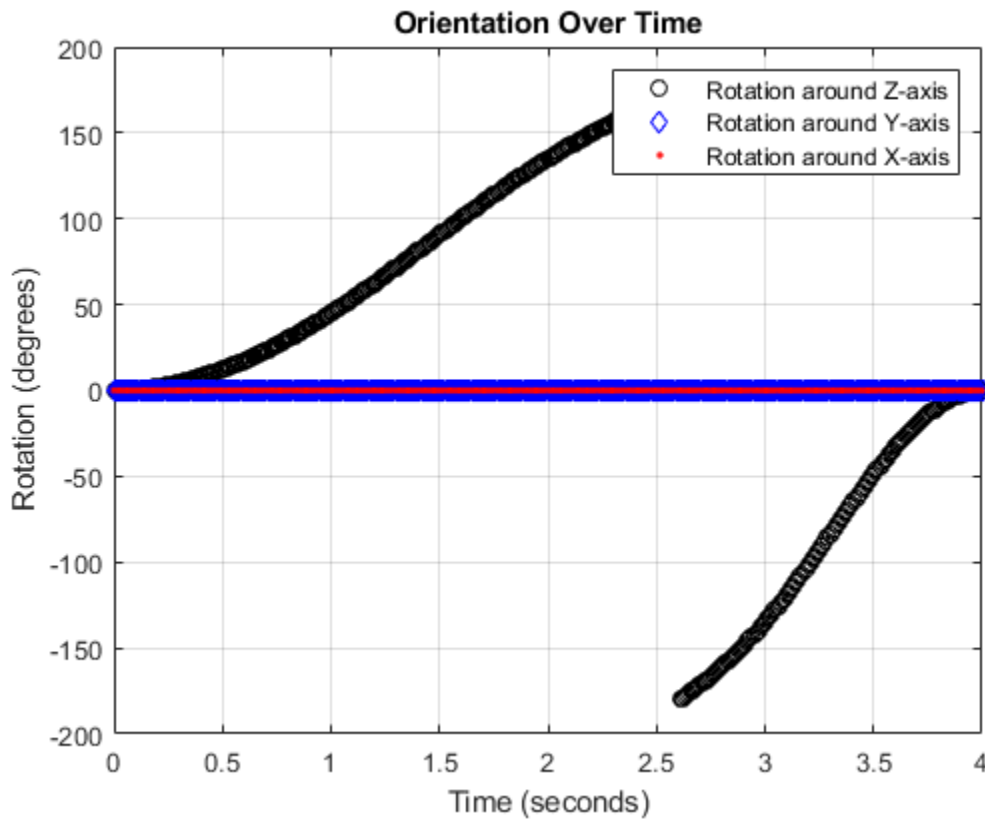
The waypointTrajectory algorithm interpolates the waypoints to create a smooth trajectory. To return to the square trajectory, provide more waypoints, especially around sharp changes. To track corresponding times, waypoints, and orientation, specify all the trajectory info in a single matrix.

```

% Time, Waypoint, Orientation
trajectoryInfo = [0, 0,0,0, 0,0,0; ... % Initial position
                 0.1, 0,0.1,0, 0,0,0; ...
                 0.9, 0,0.9,0, 0,0,0; ...
                 1, 0,1,0, 45,0,0; ...
                 1.1, 0.1,1,0, 90,0,0; ...
                 1.9, 0.9,1,0, 90,0,0; ...
                 2, 1,1,0, 135,0,0; ...
                 2.1, 1,0.9,0, 180,0,0; ...
                 2.9, 1,0.1,0, 180,0,0; ...
                 3, 1,0,0, 225,0,0; ...
                 3.1, 0.9,0,0, 270,0,0; ...
                 3.9, 0.1,0,0, 270,0,0; ...
                 4, 0,0,0, 270,0,0]; % Final position

trajectory = waypointTrajectory(trajectoryInfo(:,2:4), ...
    'TimeOfArrival',trajectoryInfo(:,1), ...
    'Orientation',quaternion(trajectoryInfo(:,5:end),'eulerd','ZYX','frame'), ...
    'SampleRate',100);

```

Create a figure and plot the initial position of the platform. In a loop, step through the trajectory to output the current position and current orientation. Plot the current position and log the orientation. Use `pause` to mimic real-time processing.

```
figure(1)
plot(waypoints(1,1),waypoints(1,2), 'b*')
title('Position')
axis([-1,2,-1,2])
axis square
xlabel('X')
ylabel('Y')
grid on
hold on

orientationLog = zeros(toa(end)*trajectory.SampleRate,1, 'quaternion');
count = 1;
while ~isDone(trajectory)
    [currentPosition,orientationLog(count)] = trajectory();

    plot(currentPosition(1),currentPosition(2), 'bo')

    pause(trajectory.SamplesPerFrame/trajectory.SampleRate)
    count = count+1;
end
hold off
```

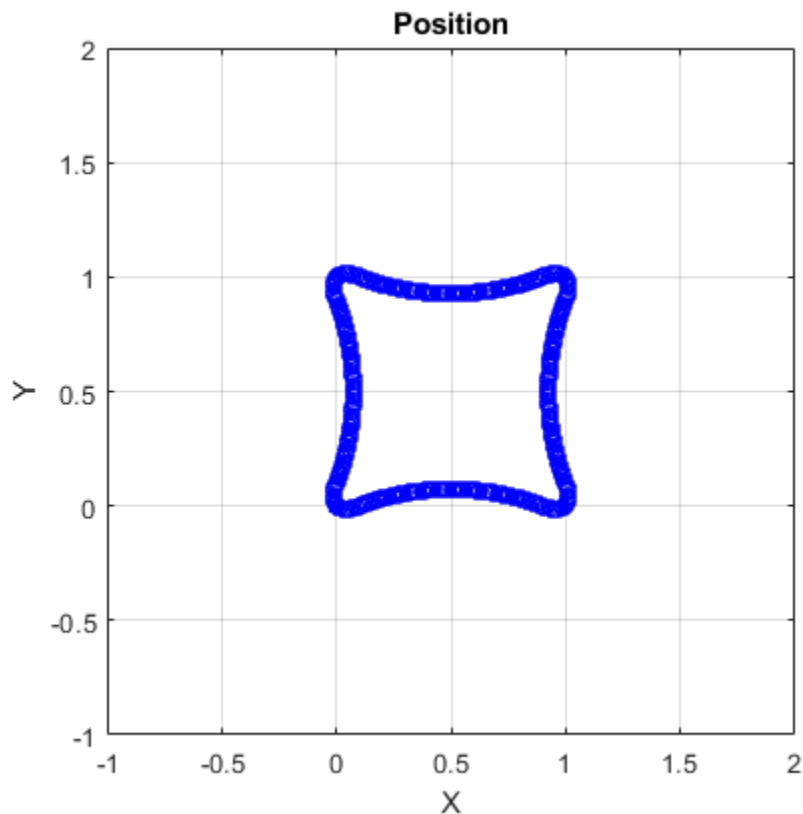

The trajectory output now appears more square-like, especially around the vertices with waypoints.

Convert the orientation quaternions to Euler angles for easy interpretation, and then plot orientation over time.

```
figure(2)
eulerAngles = eulerd([orientation(1);orientationLog],'ZYX','frame');
t = 0:1/trajectory.SampleRate:4;
eulerAngles = plot(t,eulerAngles(:,1),'ko', ...
                  t,eulerAngles(:,2),'bd', ...
                  t,eulerAngles(:,3),'r.');
```

```
title('Orientation Over Time')
legend('Rotation around Z-axis', ...
       'Rotation around Y-axis', ...
       'Rotation around X-axis', ...
       'Location', 'SouthWest')
xlabel('Time (seconds)')
ylabel('Rotation (degrees)')
grid on
```

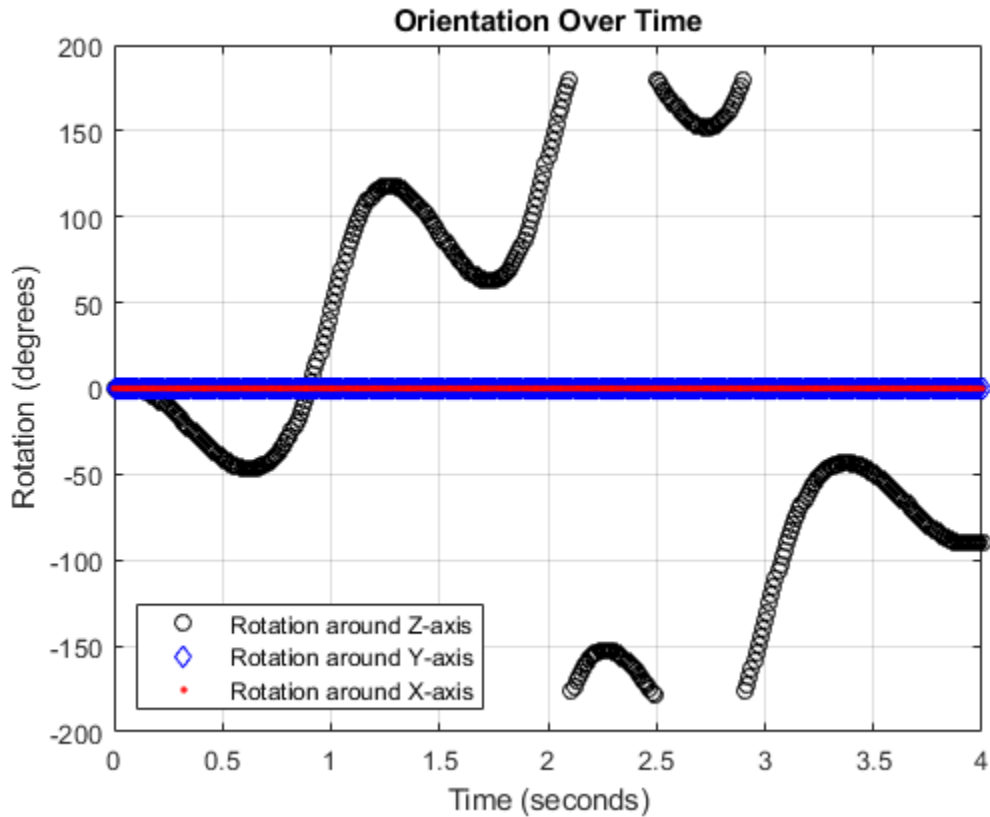

Create Arc Trajectory

This example shows how to create an arc trajectory using the `waypointTrajectory` System object™. `waypointTrajectory` creates a path through specified waypoints that minimizes acceleration and angular velocity. After creating an arc trajectory, you restrict the trajectory to be within preset bounds.

Create an Arc Trajectory

Define a constraints matrix consisting of waypoints, times of arrival, and orientation for an arc trajectory. The generated trajectory passes through the waypoints at the specified times with the specified orientation. The `waypointTrajectory` System object requires orientation to be specified using quaternions or rotation matrices. Convert the Euler angles saved in the constraints matrix to quaternions when specifying the `Orientation` property.

```
% Arrival, Waypoints, Orientation
constraints = [0,    20,20,0,    90,0,0;
              3,    50,20,0,    90,0,0;
              4,    58,15.5,0, 162,0,0;
              5.5, 59.5,0,0    180,0,0];

trajectory = waypointTrajectory(constraints(:,2:4), ...
    'TimeOfArrival',constraints(:,1), ...
    'Orientation',quaternion(constraints(:,5:7),'eulerd','ZYX','frame'));
```

Call `waypointInfo` on `trajectory` to return a table of your specified constraints. The creation properties `Waypoints`, `TimeOfArrival`, and `Orientation` are variables of the table. The table is convenient for indexing while plotting.

```
tInfo = waypointInfo(trajectory)
```

```
tInfo =
```

```
4x3 table
```

TimeOfArrival	Waypoints			Orientation
0	20	20	0	{1x1 quaternion}
3	50	20	0	{1x1 quaternion}
4	58	15.5	0	{1x1 quaternion}
5.5	59.5	0	0	{1x1 quaternion}

The trajectory object outputs the current position, velocity, acceleration, and angular velocity at each call. Call `trajectory` in a loop and plot the position over time. Cache the other outputs.

```
figure(1)
plot(tInfo.Waypoints(1,1),tInfo.Waypoints(1,2),'b*')
title('Position')
axis([20,65,0,25])
xlabel('North')
ylabel('East')
grid on
daspect([1 1 1])
hold on

orient = zeros(tInfo.TimeOfArrival(end)*trajectory.SampleRate,1,'quaternion');
vel = zeros(tInfo.TimeOfArrival(end)*trajectory.SampleRate,3);
acc = vel;
angVel = vel;

count = 1;
while ~isDone(trajectory)
```

```

[pos,orient(count),vel(count,:),acc(count,:),angVel(count,:)] = trajectory();
plot(pos(1),pos(2),'bo')

pause(trajectory.SamplesPerFrame/trajectory.SampleRate)
count = count + 1;
end

```

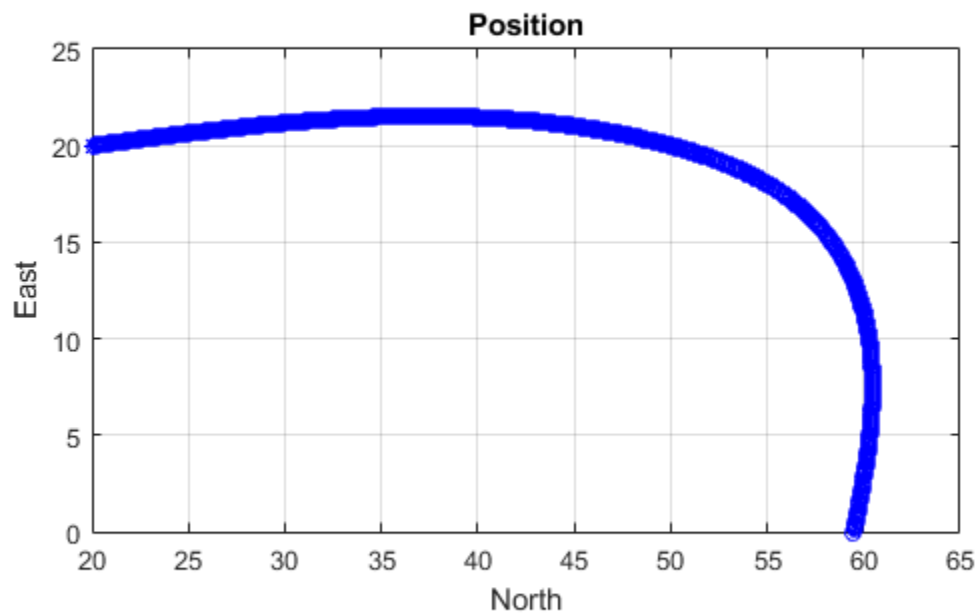

Inspect the orientation, velocity, acceleration, and angular velocity over time. The `waypointTrajectory` System object™ creates a path through the specified constraints that minimized acceleration and angular velocity.

```

figure(2)
timeVector = 0:(1/trajectory.SampleRate):tInfo.TimeOfArrival(end);
eulerAngles = eulerd([tInfo.Orientation{1};orient],'ZYX','frame');
plot(timeVector,eulerAngles(:,1), ...
      timeVector,eulerAngles(:,2), ...
      timeVector,eulerAngles(:,3));
title('Orientation Over Time')
legend('Rotation around Z-axis', ...
       'Rotation around Y-axis', ...
       'Rotation around X-axis', ...
       'Location','southwest')
xlabel('Time (seconds)')
ylabel('Rotation (degrees)')
grid on

```

```
figure(3)
plot(timeVector(2:end),vel(:,1), ...
      timeVector(2:end),vel(:,2), ...
      timeVector(2:end),vel(:,3));
title('Velocity Over Time')
legend('North','East','Down')
xlabel('Time (seconds)')
ylabel('Velocity (m/s)')
grid on

figure(4)
plot(timeVector(2:end),acc(:,1), ...
      timeVector(2:end),acc(:,2), ...
      timeVector(2:end),acc(:,3));
title('Acceleration Over Time')
legend('North','East','Down','Location','southwest')
xlabel('Time (seconds)')
ylabel('Acceleration (m/s^2)')
grid on

figure(5)
plot(timeVector(2:end),angVel(:,1), ...
      timeVector(2:end),angVel(:,2), ...
      timeVector(2:end),angVel(:,3));
title('Angular Velocity Over Time')
legend('North','East','Down')
xlabel('Time (seconds)')
ylabel('Angular Velocity (rad/s)')
grid on
```

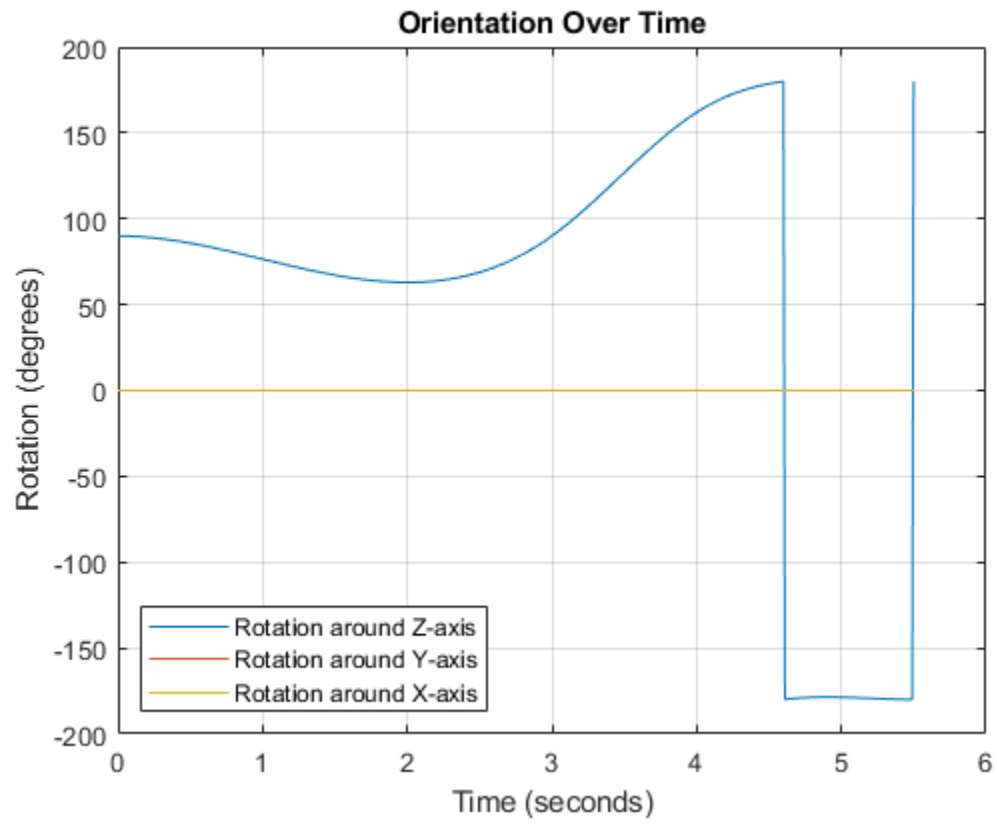

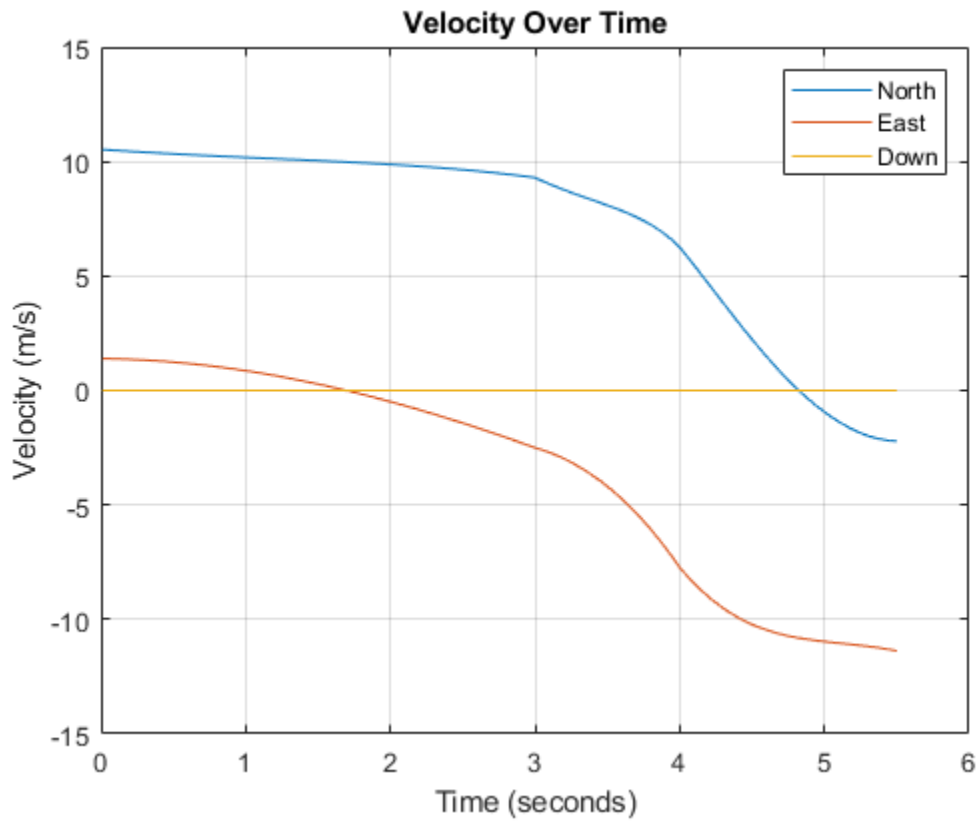

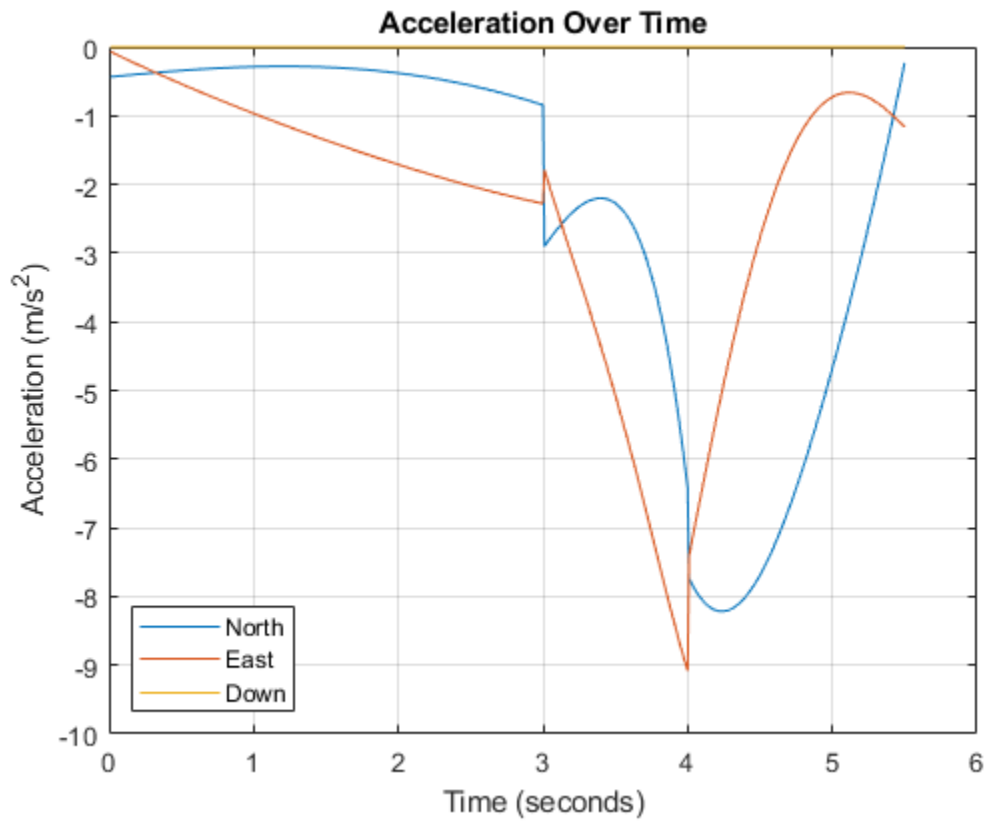

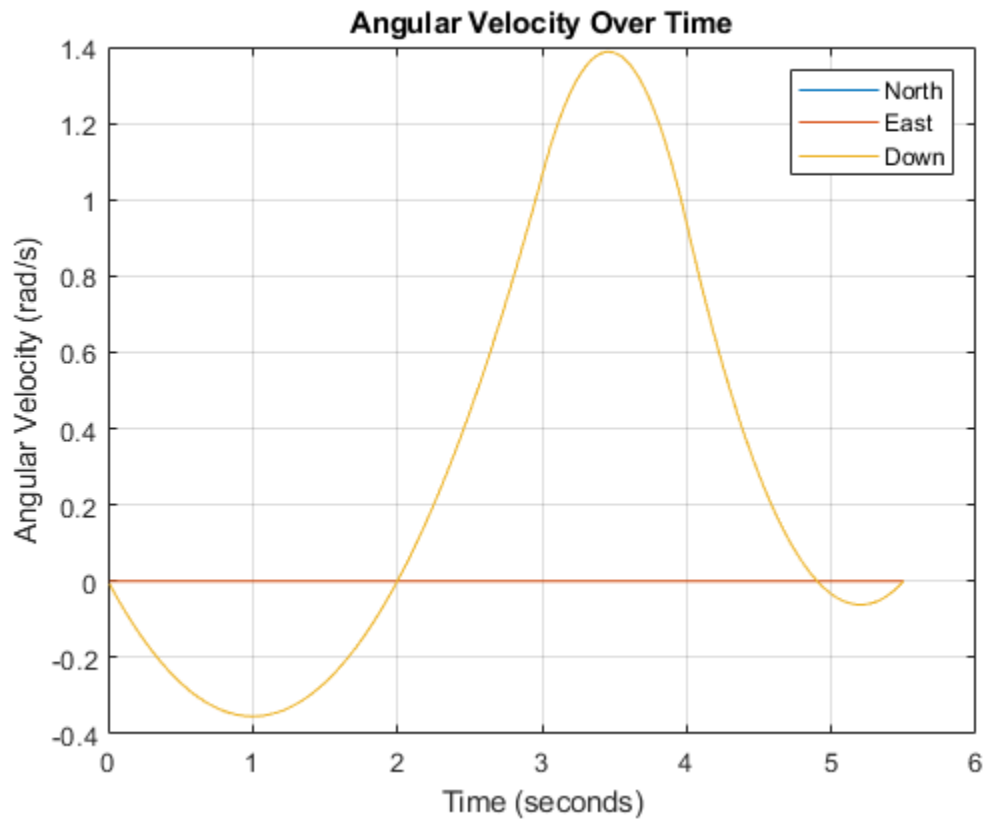

Restrict Arc Trajectory Within Preset Bounds

You can specify additional waypoints to create trajectories within given bounds. Create upper and lower bounds for the arc trajectory.

```
figure(1)
xUpperBound = [(20:50)';50+10*sin(0:0.1:pi/2)';60*ones(11,1)];
yUpperBound = [20.5.*ones(31,1);10.5+10*cos(0:0.1:pi/2)';(10:-1:0)'];

xLowerBound = [(20:49)';50+9*sin(0:0.1:pi/2)';59*ones(11,1)];
yLowerBound = [19.5.*ones(30,1);10.5+9*cos(0:0.1:pi/2)';(10:-1:0)'];

plot(xUpperBound,yUpperBound,'r','LineWidth',2);
plot(xLowerBound,yLowerBound,'r','LineWidth',2)
```

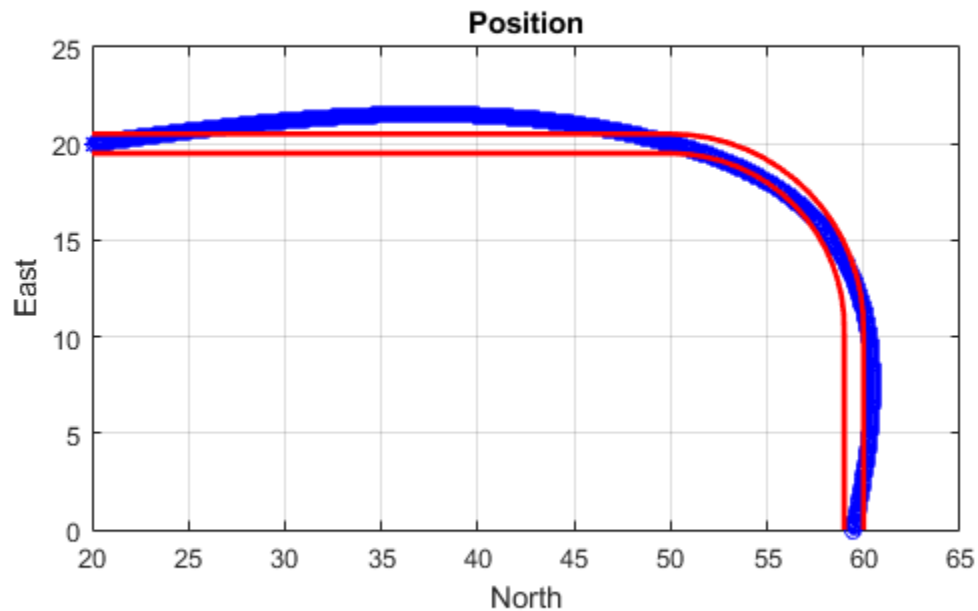

To create a trajectory within the bounds, add additional waypoints. Create a new `waypointTrajectory` System object™, and then call it in a loop to plot the generated trajectory. Cache the orientation, velocity, acceleration, and angular velocity output from the trajectory object.

```

% Time, Waypoint, Orientation
constraints = [0, 20,20,0, 90,0,0;
              1.5, 35,20,0, 90,0,0;
              2.5, 45,20,0, 90,0,0;
              3, 50,20,0, 90,0,0;
              3.3, 53,19.5,0, 108,0,0;
              3.6, 55.5,18.25,0, 126,0,0;
              3.9, 57.5,16,0, 144,0,0;
              4.2, 59,14,0, 162,0,0;
              4.5, 59.5,10,0, 180,0,0;
              5, 59.5,5,0, 180,0,0;
              5.5, 59.5,0,0, 180,0,0];

trajectory = waypointTrajectory(constraints(:,2:4), ...
    'TimeOfArrival',constraints(:,1), ...
    'Orientation',quaternion(constraints(:,5:7),'eulerd','ZYX','frame'));
tInfo = waypointInfo(trajectory);

figure(1)
plot(tInfo.Waypoints(1,1),tInfo.Waypoints(1,2),'b*')

count = 1;

```

```

while ~isDone(trajjectory)
    [pos,orient(count),vel(count,:),acc(count,:),angVel(count,:)] = trajjectory();

    plot(pos(1),pos(2),'gd')

    pause(trajjectory.SamplesPerFrame/trajjectory.SampleRate)
    count = count + 1;
end

```

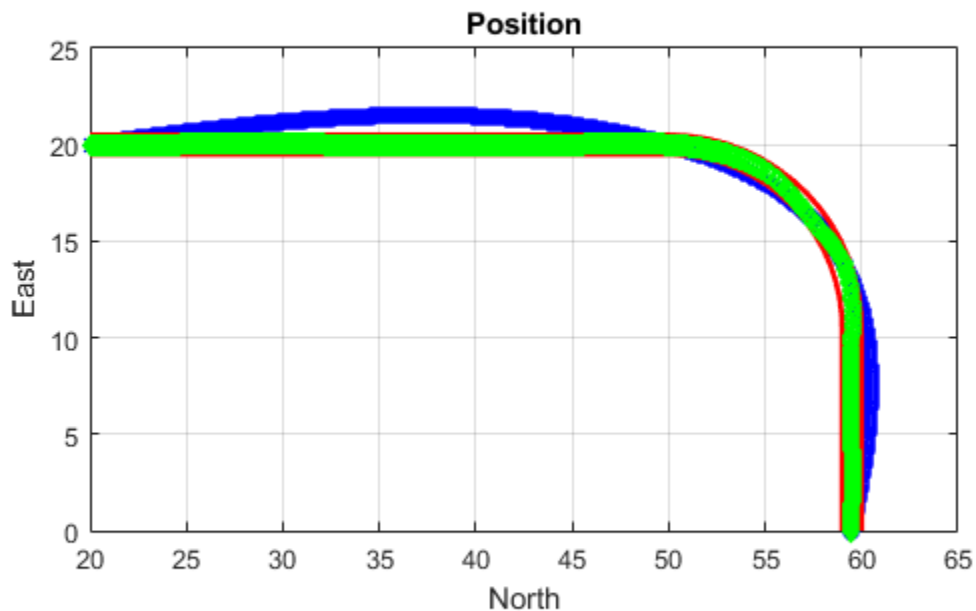

The generated trajectory now fits within the specified boundaries. Visualize the orientation, velocity, acceleration, and angular velocity of the generated trajectory.

```

figure(2)
timeVector = 0:(1/trajjectory.SampleRate):tInfo.TimeOfArrival(end);
eulerAngles = eulerd(orient,'ZYX','frame');
plot(timeVector(2:end),eulerAngles(:,1), ...
      timeVector(2:end),eulerAngles(:,2), ...
      timeVector(2:end),eulerAngles(:,3));
title('Orientation Over Time')
legend('Rotation around Z-axis', ...
       'Rotation around Y-axis', ...
       'Rotation around X-axis', ...
       'Location','southwest')
xlabel('Time (seconds)')
ylabel('Rotation (degrees)')
grid on

figure(3)

```

```
plot(timeVector(2:end),vel(:,1), ...
      timeVector(2:end),vel(:,2), ...
      timeVector(2:end),vel(:,3));
title('Velocity Over Time')
legend('North','East','Down')
xlabel('Time (seconds)')
ylabel('Velocity (m/s)')
grid on

figure(4)
plot(timeVector(2:end),acc(:,1), ...
      timeVector(2:end),acc(:,2), ...
      timeVector(2:end),acc(:,3));
title('Acceleration Over Time')
legend('North','East','Down')
xlabel('Time (seconds)')
ylabel('Acceleration (m/s^2)')
grid on

figure(5)
plot(timeVector(2:end),angVel(:,1), ...
      timeVector(2:end),angVel(:,2), ...
      timeVector(2:end),angVel(:,3));
title('Angular Velocity Over Time')
legend('North','East','Down')
xlabel('Time (seconds)')
ylabel('Angular Velocity (rad/s)')
grid on
```

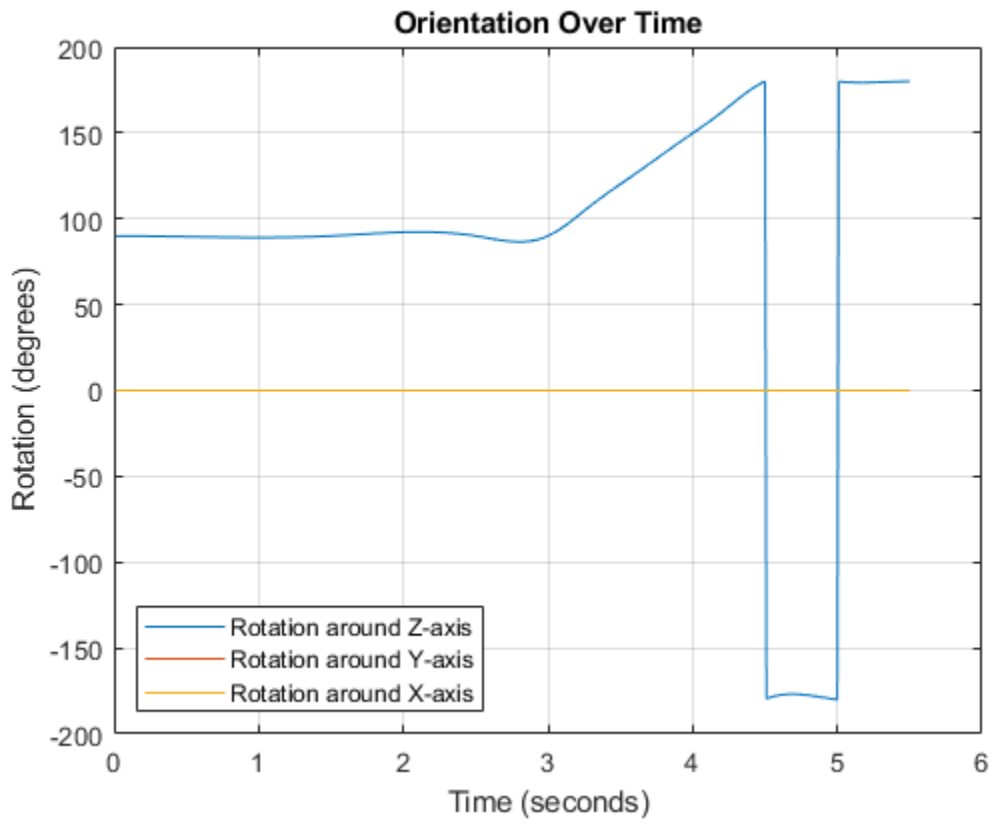

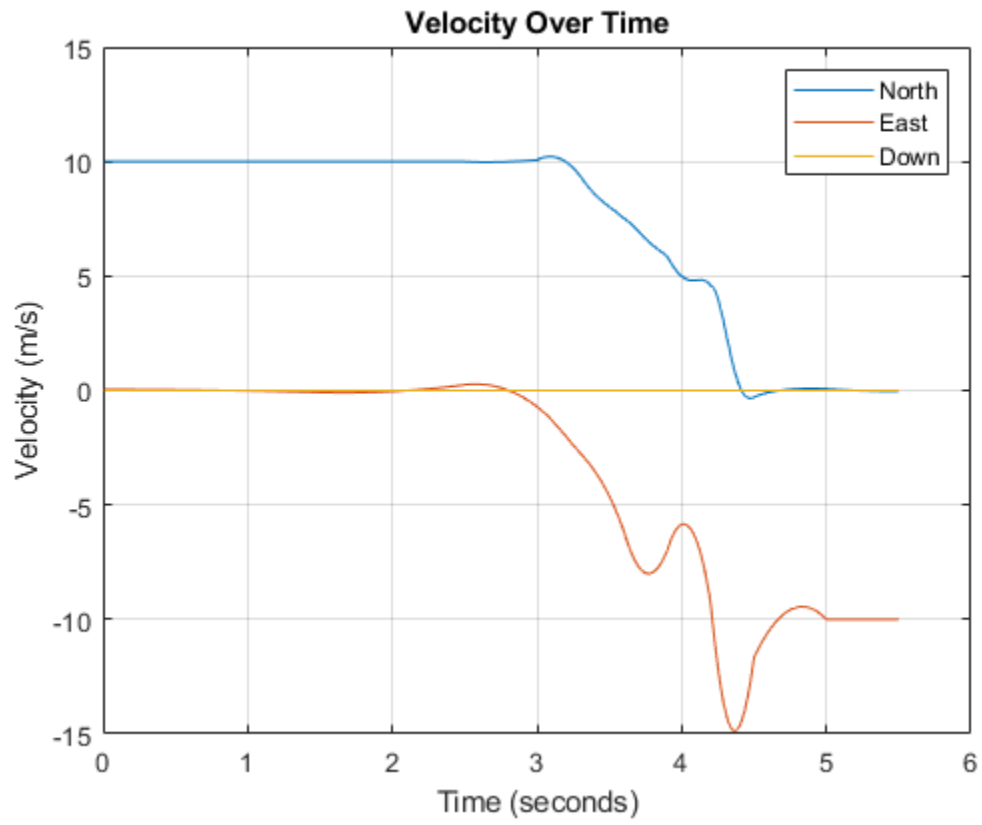

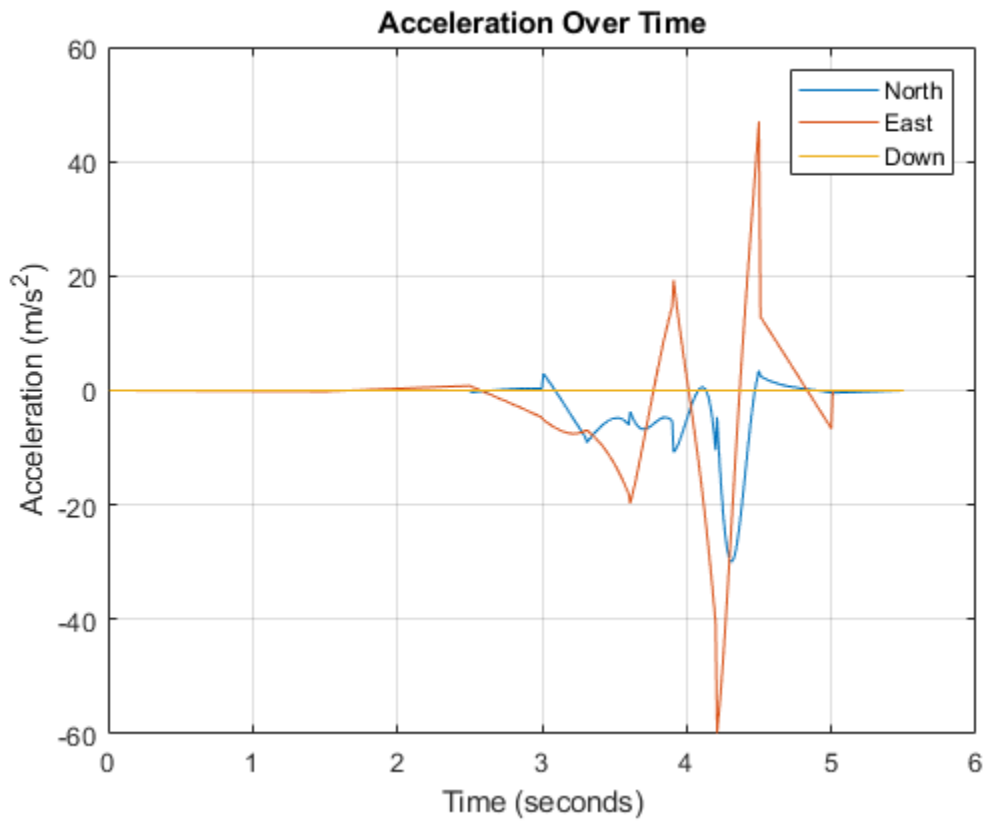

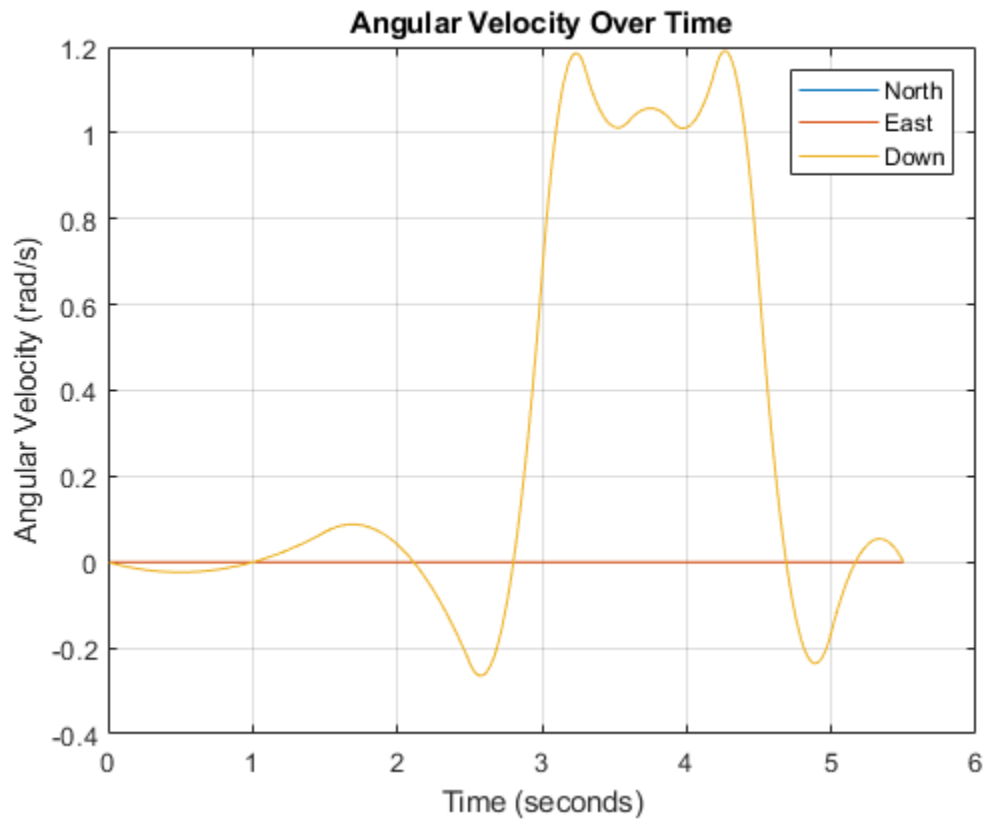

Note that while the generated trajectory now fits within the spatial boundaries, the acceleration and angular velocity of the trajectory are somewhat erratic. This is due to over-specifying waypoints.

Algorithms

The `waypointTrajectory` System object defines a trajectory that smoothly passes through waypoints. The trajectory connects the waypoints through an interpolation that assumes the gravity direction expressed in the trajectory reference frame is constant. Generally, you can use `waypointTrajectory` to model platform or vehicle trajectories within a hundreds of kilometers distance span.

The planar path of the trajectory (the x - y plane projection) consists of piecewise, clothoid curves. The curvature of the curve between two consecutive waypoints varies linearly with the curve length between them. The tangent direction of the path at each waypoint is chosen to minimize discontinuities in the curvature, unless the course is specified explicitly via the `Course` property or implicitly via the `Velocities` property. Once the path is established, the object uses cubic Hermite interpolation to compute the location of the vehicle throughout the path as a function of time and the planar distance travelled.

The normal component (z -component) of the trajectory is subsequently chosen to satisfy a shape-preserving piecewise spline (PCHIP) unless the climb rate is specified explicitly via the `ClimbRate` property or the third column of the `Velocities` property. Choose the sign of the climb rate based on the selected `ReferenceFrame`:

- When an 'ENU' reference frame is selected, specifying a positive climb rate results in an increasing value of z.
- When an 'NED' reference frame is selected, specifying a positive climb rate results in a decreasing value of z.

You can define the orientation of the vehicle through the path in two primary ways:

- If the **Orientation** property is specified, then the object uses a piecewise-cubic, quaternion spline to compute the orientation along the path as a function of time.
- If the **Orientation** property is not specified, then the yaw of the vehicle is always aligned with the path. The roll and pitch are then governed by the **AutoBank** and **AutoPitch** property values, respectively.

AutoBank	AutoPitch	Description
false	false	The vehicle is always level (zero pitch and roll). This is typically used for large marine vessels.
false	true	The vehicle pitch is aligned with the path, and its roll is always zero. This is typically used for ground vehicles.
true	false	The vehicle pitch and roll are chosen so that its local z-axis is aligned with the net acceleration (including gravity). This is typically used for rotary-wing craft.
true	true	The vehicle roll is chosen so that its local transverse plane aligns with the net acceleration (including gravity). The vehicle pitch is aligned with the path. This is typically used for two-wheeled vehicles and fixed-wing aircraft.

Extended Capabilities

C/C++ Code Generation

Generate C and C++ code using MATLAB® Coder™.

The object function, `waypointInfo`, does not support code generation.

Usage notes and limitations:

See “System Objects in MATLAB Code Generation” (MATLAB Coder).

See Also

Platform | kinematicTrajectory | trackingScenario

Introduced in R2018b

perturb

Apply perturbations to object

Syntax

```
offsets = perturb(obj)
```

Description

`offsets = perturb(obj)` applies the perturbations defined on the object, `obj` and returns the offset values. You can define perturbations on the object by using the `perturbations` function.

Examples

Perturb Waypoint Trajectory

Define a waypoint trajectory. By default, this trajectory contains two waypoints.

```
traj = waypointTrajectory
traj =
  waypointTrajectory with properties:
    SampleRate: 100
    SamplesPerFrame: 1
    Waypoints: [2x3 double]
    TimeOfArrival: [2x1 double]
    Velocities: [2x3 double]
    Course: [2x1 double]
    GroundSpeed: [2x1 double]
    ClimbRate: [2x1 double]
    Orientation: [2x1 quaternion]
    AutoPitch: 0
    AutoBank: 0
    ReferenceFrame: 'NED'
```

Define perturbations on the `Waypoints` property and the `TimeOfArrival` property.

```
rng(2020);
perturbs1 = perturbations(traj, 'Waypoints', 'Normal', 1, 1)
```

```
perturbs1=2x3 table
  Property      Type      Value
  _____  _____  _____
  "Waypoints"   "Normal"  {[ 1]}   {[ 1]}
  "TimeOfArrival" "None"    {[NaN]}  {[NaN]}
```

```
perturbs2 = perturbations(traj, 'TimeOfArrival', 'Selection', {[0;1],[0;2]})
```

```

perturbs2=2x3 table
Property          Type          Value
-----
"Waypoints"      "Normal"      {[ 1]}
"TimeOfArrival" "Selection"   {[0.5000 0.5000]}

```

Perturb the trajectory.

```
offsets = perturb(traj)
```

```

offsets=2x1 struct array with fields:
  Property
  Offset
  PerturbedValue

```

The `Waypoints` property and the `TimeOfArrival` property have changed.

```
traj.Waypoints
```

```
ans = 2x3
```

```

    1.8674    1.0203    0.7032
    2.3154   -0.3207    0.0999

```

```
traj.TimeOfArrival
```

```
ans = 2x1
```

```

    0
    2

```

Perturb Accuracy of insSensor

Create an `insSensor` object.

```
sensor = insSensor
```

```
sensor =
```

```
insSensor with properties:
```

```

    MountingLocation: [0 0 0]
    RollAccuracy: 0.2      deg
    PitchAccuracy: 0.2    deg
    YawAccuracy: 1        deg
    PositionAccuracy: [1 1 1] m
    VelocityAccuracy: 0.05 m/s
    AccelerationAccuracy: 0 m/s2
    AngularVelocityAccuracy: 0 deg/s
    TimeInput: 0
    RandomStream: 'Global stream'

```

Define the perturbation on the RollAccuracy property as three values with an equal possibility each.

```
values = {0.1 0.2 0.3}
```

```
values=1x3 cell array
    {[0.1000]}    {[0.2000]}    {[0.3000]}
```

```
probabilities = [1/3 1/3 1/3]
```

```
probabilities = 1x3
    0.3333    0.3333    0.3333
```

```
perturbations(sensor, 'RollAccuracy', 'Selection', values, probabilities)
```

```
ans=7x3 table
      Property      Type      Value
-----
"RollAccuracy"    "Selection"  {1x3 cell}  {[0.3333 0.3333 0.3333]}
"PitchAccuracy"   "None"      {[ NaN]}   {[ NaN]}
"YawAccuracy"     "None"      {[ NaN]}   {[ NaN]}
"PositionAccuracy" "None"      {[ NaN]}   {[ NaN]}
"VelocityAccuracy" "None"      {[ NaN]}   {[ NaN]}
"AccelerationAccuracy" "None"     {[ NaN]}   {[ NaN]}
"AngularVelocityAccuracy" "None"     {[ NaN]}   {[ NaN]}
```

Perturb the sensor object using the perturb function.

```
rng(2020)
perturb(sensor);
sensor
```

```
sensor =
  insSensor with properties:
    MountingLocation: [0 0 0]
    RollAccuracy: 0.5      deg
    PitchAccuracy: 0.2    deg
    YawAccuracy: 1        deg
    PositionAccuracy: [1 1 1] m
    VelocityAccuracy: 0.05 m/s
    AccelerationAccuracy: 0 m/s2
    AngularVelocityAccuracy: 0 deg/s
    TimeInput: 0
    RandomStream: 'Global stream'
```

The RollAccuracy is perturbed to 0.5 deg.

Input Arguments

obj — Object for perturbation

objects

Object for perturbation, specified as an object. The objects that you can perturb include:

- waypointTrajectory
- geoTrajectory
- kinematicTrajectory
- insSensor
- radarEmitter
- fusionRadarSensor
- sonarEmitter
- sonarSensor
- irSensor
- monostaticLidarSensor

Output Arguments

offsets — Property offsets

array of structure

Property offsets, returned as an array of structures. Each structure contains these fields:

Field Name	Description
Property	Name of perturbed property
Offset	Offset values applied in the perturbation
PerturbedValue	Property values after the perturbation

See Also

perturbations

Introduced in R2020b

perturbations

Perturbation defined on object

Syntax

```
perturbs = perturbations(obj)
perturbs = perturbations(obj,property)
perturbs = perturbations(obj,property,'None')
perturbs = perturbations(obj,property,'Selection',values,probabilities)
perturbs = perturbations(obj,property,'Normal',mean,deviation)
perturbs = perturbations(obj,property,'Uniform',minVal,maxVal)
perturbs = perturbations(obj,property,'Custom',perturbFcn)
```

Description

`perturbs = perturbations(obj)` returns the list of property perturbations, `perturbs`, defined on the object, `obj`. The returned `perturbs` lists all the perturbable properties. If any property is not perturbed, then its corresponding Type is returned as "Null" and its corresponding Value is returned as {Null,Null}.

`perturbs = perturbations(obj,property)` returns the current perturbation applied to the specified property.

`perturbs = perturbations(obj,property,'None')` defines a property that must not be perturbed.

`perturbs = perturbations(obj,property,'Selection',values,probabilities)` defines the property perturbation offset drawn from a set of values that have corresponding probabilities.

`perturbs = perturbations(obj,property,'Normal',mean,deviation)` defines the property perturbation offset drawn from a normal distribution with specified mean and standard deviation.

`perturbs = perturbations(obj,property,'Uniform',minVal,maxVal)` defines the property perturbation offset drawn from a uniform distribution on an interval [`minVal`, `maxValue`].

`perturbs = perturbations(obj,property,'Custom',perturbFcn)` enables you to define a custom function, `perturbFcn`, that draws the perturbation offset value.

Examples

Default Perturbation Properties of `waypointTrajectory`

Create a `waypointTrajectory` object.

```
traj = waypointTrajectory;
```

Show the default perturbation properties using the `perturbations` method.

```
perturbs = perturbations(traj)
```

```
perturbs=2×3 table
```

Property	Type	Value	
"Waypoints"	"None"	{[NaN]}	{[NaN]}
"TimeOfArrival"	"None"	{[NaN]}	{[NaN]}

Perturb Accuracy of insSensor

Create an insSensor object.

```
sensor = insSensor
```

```
sensor =
```

```
insSensor with properties:
```

```

    MountingLocation: [0 0 0]
        RollAccuracy: 0.2           deg
        PitchAccuracy: 0.2         deg
        YawAccuracy: 1             deg
    PositionAccuracy: [1 1 1]      m
    VelocityAccuracy: 0.05         m/s
    AccelerationAccuracy: 0         m/s2
    AngularVelocityAccuracy: 0      deg/s
    TimeInput: 0
    RandomStream: 'Global stream'
```

Define the perturbation on the RollAccuracy property as three values with an equal possibility each.

```
values = {0.1 0.2 0.3}
```

```
values=1×3 cell array
```

```
{[0.1000]} {[0.2000]} {[0.3000]}
```

```
probabilities = [1/3 1/3 1/3]
```

```
probabilities = 1×3
```

```
0.3333 0.3333 0.3333
```

```
perturbations(sensor, 'RollAccuracy', 'Selection', values, probabilities)
```

```
ans=7×3 table
```

Property	Type	Value	
"RollAccuracy"	"Selection"	{1×3 cell}	{[0.3333 0.3333 0.3333]}
"PitchAccuracy"	"None"	{[NaN]}	{[NaN]}
"YawAccuracy"	"None"	{[NaN]}	{[NaN]}

```

"PositionAccuracy"      "None"      {[ NaN]}    {[ NaN]}
"VelocityAccuracy"     "None"      {[ NaN]}    {[ NaN]}
"AccelerationAccuracy" "None"      {[ NaN]}    {[ NaN]}
"AngularVelocityAccuracy" "None"     {[ NaN]}    {[ NaN]}

```

Perturb the sensor object using the perturb function.

```

rng(2020)
perturb(sensor);
sensor

sensor =
  insSensor with properties:

    MountingLocation: [0 0 0]
    RollAccuracy: 0.5      deg
    PitchAccuracy: 0.2    deg
    YawAccuracy: 1        deg
    PositionAccuracy: [1 1 1] m
    VelocityAccuracy: 0.05 m/s
    AccelerationAccuracy: 0 m/s2
    AngularVelocityAccuracy: 0 deg/s
    TimeInput: 0
    RandomStream: 'Global stream'

```

The RollAccuracy is perturbed to 0.5 deg.

Perturb Waypoint Trajectory

Define a waypoint trajectory. By default, this trajectory contains two waypoints.

```

traj = waypointTrajectory

traj =
  waypointTrajectory with properties:

    SampleRate: 100
    SamplesPerFrame: 1
    Waypoints: [2x3 double]
    TimeOfArrival: [2x1 double]
    Velocities: [2x3 double]
    Course: [2x1 double]
    GroundSpeed: [2x1 double]
    ClimbRate: [2x1 double]
    Orientation: [2x1 quaternion]
    AutoPitch: 0
    AutoBank: 0
    ReferenceFrame: 'NED'

```

Define perturbations on the Waypoints property and the TimeOfArrival property.

```

rng(2020);
perturbs1 = perturbations(traj, 'Waypoints', 'Normal', 1, 1)

```

```
perturbs1=2x3 table
Property
```

Property	Type	Value	
"Waypoints"	"Normal"	{[1]}	{[1]}
"TimeOfArrival"	"None"	{[NaN]}	{[NaN]}

```
perturbs2 = perturbations(traj, 'TimeOfArrival', 'Selection', {[0;1],[0;2]})
```

```
perturbs2=2x3 table
Property
```

Property	Type	Value	
"Waypoints"	"Normal"	{[1]}	{[1]}
"TimeOfArrival"	"Selection"	{1x2 cell}	{[0.5000 0.5000]}

Perturb the trajectory.

```
offsets = perturb(traj)
```

```
offsets=2x1 struct array with fields:
```

```
Property
Offset
PerturbedValue
```

The Waypoints property and the TimeOfArrival property have changed.

```
traj.Waypoints
```

```
ans = 2x3
```

```
1.8674 1.0203 0.7032
2.3154 -0.3207 0.0999
```

```
traj.TimeOfArrival
```

```
ans = 2x1
```

```
0
2
```

Input Arguments

obj — Object to be perturbed

objects

Object to be perturbed, specified as an object. The objects that you can perturb include:

- waypointTrajectory
- geoTrajectory
- kinematicTrajectory

- `insSensor`
- `radarEmitter`
- `fusionRadarSensor`
- `sonarEmitter`
- `sonarSensor`
- `irSensor`
- `monostaticLidarSensor`

property — Perturbable property

property name

Perturbable property, specified as a property name. Use `perturbations` to obtain a full list of perturbable properties for the specified `obj`.

values — Perturbation offset values

n-element cell array of property values

Perturbation offset values, specified as an *n*-element cell array of property values. The function randomly draws the perturbation value for the property from the cell array based on the values' corresponding probabilities specified in the `probabilities` input.

probabilities — Drawing probabilities for each perturbation value

n-element array of nonnegative scalar

Drawing probabilities for each perturbation value, specified as an *n*-element array of nonnegative scalars, where *n* is the number of perturbation values provided in the `values` input. The sum of all elements must be equal to one.

For example, you can specify a series of perturbation value-probability pair as $\{x_1, x_2, \dots, x_n\}$ and $\{p_1, p_2, \dots, p_n\}$, where the probability of drawing x_i is p_i ($i = 1, 2, \dots, n$).

mean — Mean of normal distribution

scalar | vector | matrix

Mean of normal distribution, specified as a scalar, vector, or matrix. The dimension of `mean` must be compatible with the corresponding property that you perturb.

deviation — Standard deviation of normal distribution

nonnegative scalar | vector of nonnegative scalar | matrix of nonnegative scalar

Standard deviation of normal distribution, specified as a nonnegative scalar, vector of nonnegative scalars, or matrix of nonnegative scalars. The dimension of `deviation` must be compatible with the corresponding property that you perturb.

minVal — Minimum value of uniform distribution interval

scalar | vector | matrix

Minimum value of the uniform distribution interval, specified as a scalar, vector, or matrix. The dimension of `minVal` must be compatible with the corresponding property that you perturb.

maxVal — Maximum value of uniform distribution interval

scalar | vector | matrix

Maximum value of the uniform distribution interval, specified as a scalar, vector, or matrix. The dimension of `maxVal` must be compatible with the corresponding property that you perturb.

perturbFcn — Perturbation function

function handle

Perturbation function, specified as a function handle. The function must have this syntax:

```
offset = myfun(propVal)
```

where `propVal` is the value of the property and `offset` is the perturbation offset for the property.

Output Arguments

perturbs — Perturbations defined on object

table of perturbation property

Perturbations defined on the object, returned as a table of perturbation properties. The table has three columns:

- `Property` — Property names.
- `Type` — Type of perturbations, returned as "None", "Selection", "Normal", "Uniform", or "Custom".
- `Value` — Perturbation values, returned as a cell array.

See Also

`perturb`

Introduced in R2020b

waypointInfo

Get waypoint information table

Syntax

```
trajectoryInfo = waypointInfo(trajectory)
```

Description

`trajectoryInfo = waypointInfo(trajectory)` returns a table of waypoints, times of arrival, velocities, and orientation for the trajectory System object

Input Arguments

trajectory — Object of `waypointTrajectory`

object

Object of the `waypointTrajectory` System object.

Output Arguments

trajectoryInfo — Trajectory information

table

Trajectory information, returned as a table with variables corresponding to set creation properties: `Waypoints`, `TimeOfArrival`, `Velocities`, and `Orientation`.

The trajectory information table always has variables `Waypoints` and `TimeOfArrival`. If the `Velocities` property is set during construction, the trajectory information table additionally returns velocities. If the `Orientation` property is set during construction, the trajectory information table additionally returns orientation.

See Also

`waypointTrajectory`

Introduced in R2018b

lookupPose

Obtain pose information for certain time

Syntax

```
[position,orientation,velocity,acceleration,angularVelocity] = lookupPose(
traj,sampleTimes)
```

Description

[position,orientation,velocity,acceleration,angularVelocity] = lookupPose(traj,sampleTimes) returns the pose information of the waypoint trajectory at the specified sample times. If any sample time is beyond the duration of the trajectory, the corresponding pose information is returned as NaN.

Input Arguments

traj — Waypoint trajectory

waypointTrajectory object

Waypoint trajectory, specified as a waypointTrajectory object.

sampleTimes — Sample times

M -element vector of nonnegative scalar

Sample times in seconds, specified as an M -element vector of nonnegative scalars.

Output Arguments

position — Position in local navigation coordinate system (m)

M -by-3 matrix

Position in the local navigation coordinate system in meters, returned as an M -by-3 matrix.

M is specified by the sampleTimes input.

Data Types: double

orientation — Orientation in local navigation coordinate system

M -element quaternion column vector | 3-by-3-by- M real array

Orientation in the local navigation coordinate system, returned as an M -by-1 quaternion column vector or a 3-by-3-by- M real array.

Each quaternion or 3-by-3 rotation matrix is a frame rotation from the local navigation coordinate system to the current body coordinate system.

M is specified by the sampleTimes input.

Data Types: double

velocity — Velocity in local navigation coordinate system (m/s)*M*-by-3 matrix

Velocity in the local navigation coordinate system in meters per second, returned as an *M*-by-3 matrix.

M is specified by the `sampleTimes` input.

Data Types: `double`

acceleration — Acceleration in local navigation coordinate system (m/s²)*M*-by-3 matrix

Acceleration in the local navigation coordinate system in meters per second squared, returned as an *M*-by-3 matrix.

M is specified by the `sampleTimes` input.

Data Types: `double`

angularVelocity — Angular velocity in local navigation coordinate system (rad/s)*M*-by-3 matrix

Angular velocity in the local navigation coordinate system in radians per second, returned as an *M*-by-3 matrix.

M is specified by the `sampleTimes` input.

Data Types: `double`

See Also`waypointTrajectory`**Introduced in R2018b**

monostaticRadarSensor

Generate radar detections for tracking scenario

Note `monostaticRadarSensor` is not recommended unless you require C/C++ code generation. Use `fusionRadarSensor` instead. For more information, see “Compatibility Considerations”.

Description

The `monostaticRadarSensor` System object generates detections of targets by a monostatic surveillance scanning radar. You can use the `monostaticRadarSensor` object in a scenario containing moving and stationary platforms such as one created using `trackingScenario`. The `monostaticRadarSensor` object can simulate real detections with added random noise and also generate false alarm detections. In addition, you can use the detections generated by this object as input to trackers such as `trackerGNN` or `trackerTOMHT`.

This object enable you to configure a scanning radar. A scanning radar changes its look angle by stepping the mechanical and electronic position of the beam in increments of the angular span specified in the `FieldOfView` property. The radar scans the total region in azimuth and elevation defined by the radar mechanical and electronic scan limits, `MechanicalScanLimits` and `ElectronicScanLimits`. If the scanning limits for azimuth or elevation are set to `[0 0]`, then no scanning is performed along that dimension for that scan mode. If the maximum mechanical scan rate for azimuth or elevation is set to zero, then no mechanical scanning is performed along that dimension.

Using a single-exponential mode, the radar computes range and elevation biases caused by propagation through the troposphere. A range bias means that measured ranges are greater than the line-of-sight range to the target. Elevation bias means that the measured elevations are above their true elevations. Biases are larger when the line-of-sight path between the radar and target passes through lower altitudes because the atmosphere is thicker.

To generate radar detections:

- 1 Create the `monostaticRadarSensor` object and set its properties.
- 2 Call the object with arguments, as if it were a function.

To learn more about how System objects work, see [What Are System Objects?](#).

Creation

Syntax

```
sensor = monostaticRadarSensor(SensorIndex)
sensor = monostaticRadarSensor(SensorIndex, Name, Value)

sensor = monostaticRadarSensor(SensorIndex, 'No scanning')
sensor = monostaticRadarSensor(SensorIndex, 'Raster')
```

```
sensor = monostaticRadarSensor(SensorIndex, 'Rotator')  
sensor = monostaticRadarSensor(SensorIndex, 'Sector')
```

Description

`sensor = monostaticRadarSensor(SensorIndex)` creates a radar detection generator object with a specified sensor index, `SensorIndex`, and default property values.

`sensor = monostaticRadarSensor(SensorIndex, Name, Value)` sets properties using one or more name-value pairs. Enclose each property name in quotes. For example, `monostaticRadarSensor(1, 'DetectionCoordinates', 'Sensor_rectangular')` creates a radar detection generator that reports detections in the sensor Cartesian coordinate system with sensor index equal to 1.

`sensor = monostaticRadarSensor(SensorIndex, 'No_scanning')` is a convenience syntax that creates a `monostaticRadarSensor` that only points along the radar antenna boresight direction. No mechanical or electronic scanning is performed. This syntax sets the `ScanMode` property to `'No_scanning'`.

`sensor = monostaticRadarSensor(SensorIndex, 'Raster')` is a convenience syntax that creates a `monostaticRadarSensor` object that mechanically scans a raster pattern. The raster span is 90° in azimuth from -45° to +45° and in elevation from the horizon to 10° above the horizon. See “Convenience Syntaxes” on page 3-283 for the properties set by this syntax.

`sensor = monostaticRadarSensor(SensorIndex, 'Rotator')` is a convenience syntax that creates a `monostaticRadarSensor` object that mechanically scans 360° in azimuth by mechanically rotating the antenna at a constant rate. When you set `HasElevation` to `true`, the radar antenna mechanically points towards the center of the elevation field of view. See “Convenience Syntaxes” on page 3-283 for the properties set by this syntax.

`sensor = monostaticRadarSensor(SensorIndex, 'Sector')` is a convenience syntax to create a `monostaticRadarSensor` object that mechanically scans a 90° azimuth sector from -45° to +45°. Setting `HasElevation` to `true` points the radar antenna towards the center of the elevation field of view. You can change the `ScanMode` to `'Electronic'` to electronically scan the same azimuth sector. In this case, the antenna is not mechanically tilted in an electronic sector scan. Instead, beams are stacked electronically to process the entire elevation spanned by the scan limits in a single dwell. See “Convenience Syntaxes” on page 3-283 for the properties set by this syntax.

Properties

Unless otherwise indicated, properties are *nontunable*, which means you cannot change their values after calling the object. Objects lock when you call them, and the `release` function unlocks them.

If a property is *tunable*, you can change its value at any time.

For more information on changing property values, see System Design in MATLAB Using System Objects.

SensorIndex — Unique sensor identifier

positive integer

Unique sensor identifier, specified as a positive integer. This property distinguishes detections that come from different sensors in a multi-sensor system. When creating a `monostaticRadarSensor`

system object, you must either specify the `SensorIndex` as the first input argument in the creation syntax, or specify it as the value for the `SensorIndex` property in the creation syntax.

Data Types: `double`

UpdateRate — Sensor update rate

1 (default) | positive scalar

Sensor update rate, specified as a positive scalar. This interval must be an integer multiple of the simulation time interval defined by `trackingScenario`. The `trackingScenario` object calls the radar scanning sensor at simulation time intervals. The radar generates new detections at intervals defined by the reciprocal of the `UpdateRate` property. Any update requested to the sensor between update intervals contains no detections. Units are in hertz.

Example: 5

Data Types: `double`

MountingLocation — Sensor location on platform

[0 0 0] (default) | 1-by-3 real-valued vector

Sensor location on platform, specified as a 1-by-3 real-valued vector. This property defines the coordinates of the sensor with respect to the platform origin. The default value specifies that the sensor origin is at the origin of its platform. Units are in meters.

Example: [.2 0.1 0]

Data Types: `double`

MountingAngles — Orientation of sensor

[0 0 0] (default) | 3-element real-valued vector

Orientation of the sensor with respect to the platform, specified as a three-element real-valued vector. Each element of the vector corresponds to an intrinsic Euler angle rotation that carries the body axes of the platform to the sensor axes. The three elements define the rotations around the *z*-, *y*-, and *x*-axes, in that order. The first rotation rotates the platform axes around the *z*-axis. The second rotation rotates the carried frame around the rotated *y*-axis. The final rotation rotates the frame around the carried *x*-axis. Units are in degrees.

Example: [10 20 -15]

Data Types: `double`

FieldOfView — Fields of view of sensor

[10;50] | 2-by-1 vector of positive scalar

Fields of view of sensor, specified as a 2-by-1 vector of positive scalars in degree, [`azfov`; `elfov`]. The field of view defines the total angular extent spanned by the sensor. The azimuth filed of view `azfov` must lie in the interval (0,360]. The elevation filed of view `elfov` must lie in the interval (0,180].

Example: [14;7]

Data Types: `double`

HasRangeAmbiguities — Enable range ambiguities

false (default) | true

Enable range ambiguities, specified as `false` or `true`. Set this property to `true` to enable range ambiguities by the sensor. In this case, the sensor cannot resolve range ambiguities and target ranges beyond the `MaxUnambiguousRange` are wrapped into the interval `[0 MaxUnambiguousRange]`. When `false`, targets are reported at their unambiguous range.

Data Types: `logical`

MaxUnambiguousRange — Maximum unambiguous detection range

`100e3` (default) | positive scalar

Maximum unambiguous range, specified as a positive scalar. Maximum unambiguous range defines the maximum range for which the radar can unambiguously resolve the range of a target. When `HasRangeAmbiguities` is set to `true`, targets detected at ranges beyond the maximum unambiguous range are wrapped into the range interval `[0,MaxUnambiguousRange]`. This property applies to true target detections when you set the `HasRangeAmbiguities` property to `true`.

This property also applies to false target detections when you set the `HasFalseAlarms` property to `true`. In this case, the property defines the maximum range for false alarms.

Units are in meters.

Example: `5e3`

Dependencies

To enable this property, set the `HasRangeAmbiguities` property to `true` or set the `HasFalseAlarms` property to `true`.

Data Types: `double`

HasRangeRateAmbiguities — Enable range-rate ambiguities

`false` (default) | `true`

Enable range-rate ambiguities, specified as `false` or `true`. Set to `true` to enable range-rate ambiguities by the sensor. When `true`, the sensor does not resolve range rate ambiguities and target range rates beyond the `MaxUnambiguousRadialSpeed` are wrapped into the interval `[-MaxUnambiguousRadialSpeed,MaxUnambiguousRadialSpeed]`. When `false`, targets are reported at their unambiguous range rate.

Dependencies

To enable this property, set the `HasRangeRate` property to `true`.

Data Types: `logical`

MaxUnambiguousRadialSpeed — Maximum unambiguous radial speed

`200` (default) | positive scalar

Maximum unambiguous radial speed, specified as a positive scalar. Radial speed is the magnitude of the target range rate. Maximum unambiguous radial speed defines the radial speed for which the radar can unambiguously resolve the range rate of a target. When `HasRangeRateAmbiguities` is set to `true`, targets detected at range rates beyond the maximum unambiguous radial speed are wrapped into the range rate interval `[-MaxUnambiguousRadialSpeed,MaxUnambiguousRadialSpeed]`. This property applies to true target detections when you set `HasRangeRateAmbiguities` property to `true`.

This property also applies to false target detections obtained when you set both the `HasRangeRate` and `HasFalseAlarms` properties to `true`. In this case, the property defines the maximum radial speed for which false alarms can be generated.

Units are in meters per second.

Dependencies

To enable this property, set `HasRangeRate` and `HasRangeRateAmbiguities` to `true` and/or set `HasRangeRate` and `HasFalseAlarms` to `true`.

Data Types: `double`

ScanMode — Scanning mode of radar

'Mechanical' (default) | 'Electronic' | 'Mechanical and electronic' | 'No scanning'

Scanning mode of radar, specified as 'Mechanical', 'Electronic', 'Mechanical and electronic', or 'No scanning'.

Scan Modes

ScanMode	Purpose
'Mechanical'	The radar scans mechanically across the azimuth and elevation limits specified by the <code>MechanicalScanLimits</code> property. The scan direction increments by the radar field of view angle between dwells.
'Electronic'	The radar scans electronically across the azimuth and elevation limits specified by the <code>ElectronicScanLimits</code> property. The scan direction increments by the radar field of view angle between dwells.
'Mechanical and electronic'	The radar mechanically scans the antenna boresight across the mechanical scan limits and electronically scans beams relative to the antenna boresight across the electronic scan limits. The total field of regard scanned in this mode is the combination of the mechanical and electronic scan limits. The scan direction increments by the radar field of view angle between dwells.
'No scanning'	The radar beam points along the antenna boresight defined by the <code>MountingAngles</code> property.

Example: 'No scanning'

MaxMechanicalScanRate — Maximum mechanical scan rate

[75;75] (default) | nonnegative scalar | real-valued 2-by-1 vector with nonnegative entries

Maximum mechanical scan rate, specified as a nonnegative scalar or real-valued 2-by-1 vector with nonnegative entries.

When `HasElevation` is `true`, specify the scan rate as a 2-by-1 column vector of nonnegative entries [`maxAzRate`; `maxElRate`]. `maxAzRate` is the maximum scan rate in azimuth and `maxElRate` is the maximum scan rate in elevation.

When `HasElevation` is `false`, specify the scan rate as a nonnegative scalar representing the maximum mechanical azimuth scan rate.

Scan rates set the maximum rate at which the radar can mechanically scan. The radar sets its scan rate to step the radar mechanical angle by the field of regard. If the required scan rate exceeds the maximum scan rate, the maximum scan rate is used. Units are degrees per second.

Example: [5;10]

Dependencies

To enable this property, set the `ScanMode` property to 'Mechanical' or 'Mechanical and electronic'.

Data Types: double

MechanicalScanLimits — Angular limits of mechanical scan directions of radar

[0 360; -10 0] (default) | real-valued 1-by-2 row vector | real-valued 2-by-2 matrix

Angular limits of mechanical scan directions of radar, specified as a real-valued 1-by-2 row vector or a real-valued 2-by-2 matrix. The mechanical scan limits define the minimum and maximum mechanical angles the radar can scan from its mounted orientation.

When `HasElevation` is `true`, the scan limits take the form [`minAz` `maxAz`; `minEl` `maxEl`]. `minAz` and `maxAz` represent the minimum and maximum limits of the azimuth angle scan. `minEl` and `maxEl` represent the minimum and maximum limits of the elevation angle scan. When `HasElevation` is `false`, the scan limits take the form [`minAz` `maxAz`]. If you specify the scan limits as a 2-by-2 matrix but set `HasElevation` to `false`, the second row of the matrix is ignored.

Azimuthal scan limits cannot span more than 360° and elevation scan limits must lie within the closed interval [-90° 90°]. Units are in degrees.

Example: [-90 90;0 85]

Dependencies

To enable this property, set the `ScanMode` property to 'Mechanical' or 'Mechanical and electronic'.

Data Types: double

MechanicalAngle — Current mechanical scan angle

scalar | real-valued 2-by-1 vector

This property is read-only.

Current mechanical scan angle of radar, returned as a scalar or real-valued 2-by-1 vector. When `HasElevation` is `true`, the scan angle takes the form [`Az`; `El`]. `Az` and `El` represent the azimuth and elevation scan angles, respectively, relative to the mounted angle of the radar on the platform. When `HasElevation` is `false`, the scan angle is a scalar representing the azimuth scan angle.

Dependencies

To enable this property, set the `ScanMode` property to 'Mechanical' or 'Mechanical and electronic'.

Data Types: double

ElectronicScanLimits — Angular limits of electronic scan directions of radar

`[-45 45; -45 45]` (default) | real-valued 1-by-2 row vector | real-valued 2-by-2 matrix

Angular limits of electronic scan directions of radar, specified as a real-valued 1-by-2 row vector or a real-valued 2-by-2 matrix. The electronic scan limits define the minimum and maximum electronic angles the radar can scan from its current mechanical direction.

When `HasElevation` is `true`, the scan limits take the form `[minAz maxAz; minEl maxEl]`. `minAz` and `maxAz` represent the minimum and maximum limits of the azimuth angle scan. `minEl` and `maxEl` represent the minimum and maximum limits of the elevation angle scan. When `HasElevation` is `false`, the scan limits take the form `[minAz maxAz]`. If you specify the scan limits as a 2-by-2 matrix but set `HasElevation` to `false`, the second row of the matrix is ignored.

Azimuthal scan limits and elevation scan limits must lie within the closed interval $[-90^\circ 90^\circ]$. Units are in degrees.

Example: `[-90 90; 0 85]`

Dependencies

To enable this property, set the `ScanMode` property to 'Electronic' or 'Mechanical and electronic'.

Data Types: double

ElectronicAngle — Current electronic scan angle

electronic scalar | nonnegative scalar

This property is read-only.

Current electronic scan angle of radar, returned as a scalar or 1-by-2 column vector. When `HasElevation` is `true`, the scan angle takes the form `[Az;El]`. `Az` and `El` represent the azimuth and elevation scan angles, respectively. When `HasElevation` is `false`, the scan angle is a scalar representing the azimuth scan angle.

Dependencies

To enable this property, set the `ScanMode` property to 'Electronic' or 'Mechanical and electronic'.

Data Types: double

LookAngle — Look angle of sensor

scalar | real-valued 2-by-1 vector

This property is read-only.

Look angle of sensor, specified as a scalar or real-valued 2-by-1 vector. Look angle is a combination of the mechanical angle and electronic angle depending on the `ScanMode` property.

ScanMode	LookAngle
'Mechanical'	MechanicalAngle
'Electronic'	ElectronicAngle
'Mechanical and Electronic'	MechanicalAngle + ElectronicAngle
'No scanning'	0

When `HasElevation` is true, the look angle takes the form [Az;El]. Az and El represent the azimuth and elevation look angles, respectively. When `HasElevation` is false, the look angle is a scalar representing the azimuth look angle.

DetectionProbability — Probability of detecting a target

0.9 | positive scalar less than or equal to 1

Probability of detecting a target, specified as a positive scalar less than or equal to one. This quantity defines the probability of detecting a target with a radar cross-section, `ReferenceRCS`, at the reference detection range, `ReferenceRange`.

Example: 0.95

Data Types: double

FalseAlarmRate — False alarm rate

1e-6 (default) | positive scalar

False alarm report rate within each radar resolution cell, specified as a positive scalar in the range $[10^{-7}, 10^{-3}]$. Units are dimensionless. Resolution cells are determined from the `AzimuthResolution` and `RangeResolution` properties, and the `ElevationResolution` and `RangeRateResolution` properties when they are enabled.

Example: 1e-5

Data Types: double

ReferenceRange — Reference range for given probability of detection

100e3 (default) | positive scalar

Reference range for the given probability of detection and the given reference radar cross-section (RCS), specified as a positive scalar. The reference range is the range at which a target having a radar cross-section specified by `ReferenceRCS` is detected with a probability of detection specified by `DetectionProbability`. Units are in meters.

Example: 25e3

Data Types: double

ReferenceRCS — Reference radar cross-section for given probability of detection

0 (default) | scalar

Reference radar cross-section (RCS) for given a probability of detection and reference range, specified as a scalar. The reference RCS is the RCS value at which a target is detected with probability specified by `DetectionProbability` at `ReferenceRange`. Units are in dBsm.

Example: -10

Data Types: double

RadarLoopGain — Radar loop gain

scalar

This property is read-only.

Radar loop gain, returned as a scalar. `RadarLoopGain` depends on the values of the `DetectionProbability`, `ReferenceRange`, `ReferenceRCS`, and `FalseAlarmRate` properties. Radar loop gain is a function of the reported signal-to-noise ratio of the radar, SNR , the target radar cross-section, RCS , and the target range, R . The function is

$$SNR = \text{RadarLoopGain} + RCS - 40\log_{10}(R) \quad (3-1)$$

where SNR and RCS are in dB and dBsm, respectively, and range is in meters. Radar loop gain is in dB.

Data Types: double

HasElevation — Enable radar elevation scan and measurements

false (default) | true

Enable the radar to measure target elevation angles and to scan in elevation, specified as `false` or `true`. Set this property to `true` to model a radar sensor that can estimate target elevation and scan in elevation.

Data Types: logical

HasRangeRate — Enable radar to measure range rate

false (default) | true

Enable the radar to measure target range rates, specified as `false` or `true`. Set this property to `true` to model a radar sensor that can measure target range rate. Set this property to `false` to model a radar sensor that cannot measure range rate.

Data Types: logical

AzimuthResolution — Azimuth resolution of radar

1 (default) | positive scalar

Azimuth resolution of the radar, specified as a positive scalar. The azimuth resolution defines the minimum separation in azimuth angle at which the radar can distinguish two targets. The azimuth resolution is typically the 3dB downpoint of the azimuth angle beamwidth of the radar. Units are in degrees.

Data Types: double

ElevationResolution — Elevation resolution of radar

1 (default) | positive scalar

Elevation resolution of the radar, specified as a positive scalar. The elevation resolution defines the minimum separation in elevation angle at which the radar can distinguish two targets. The elevation resolution is typically the 3dB-downpoint in elevation angle beamwidth of the radar. Units are in degrees.

Dependencies

To enable this property, set the `HasElevation` property to `true`.

Data Types: double

RangeResolution — Range resolution of radar

100 (default) | positive scalar

Range resolution of the radar, specified as a positive scalar. The range resolution defines the minimum separation in range at which the radar can distinguish between two targets. Units are in meters.

Data Types: double

RangeRateResolution — Range rate resolution of radar

10 (default) | positive scalar

Range rate resolution of the radar, specified as a positive scalar. The range rate resolution defines the minimum separation in range rate at which the radar can distinguish between two targets. Units are in meters per second.

Dependencies

To enable this property, set the `HasRangeRate` property to `true`.

Data Types: double

AzimuthBiasFraction — Azimuth bias fraction

0.1 (default) | nonnegative scalar

Azimuth bias fraction of the radar, specified as a nonnegative scalar. The azimuth bias is expressed as a fraction of the azimuth resolution specified in `AzimuthResolution`. This value sets a lower bound on the azimuthal accuracy of the radar. This value is dimensionless.

Data Types: double

ElevationBiasFraction — Elevation bias fraction

0.1 (default) | nonnegative scalar

Elevation bias fraction of the radar, specified as a nonnegative scalar. Elevation bias is expressed as a fraction of the elevation resolution specified by the value of the `ElevationResolution` property. This value sets a lower bound on the elevation accuracy of the radar. This value is dimensionless.

Dependencies

To enable this property, set the `HasElevation` property to `true`.

Data Types: double

RangeBiasFraction — Range bias fraction

0.05 (default) | nonnegative scalar

Range bias fraction of the radar, specified as a nonnegative scalar. Range bias is expressed as a fraction of the range resolution specified in `RangeResolution`. This property sets a lower bound on the range accuracy of the radar. This value is dimensionless.

Data Types: double

RangeRateBiasFraction — Range rate bias fraction

0.05 (default) | nonnegative scalar

Range rate bias fraction of the radar, specified as a nonnegative scalar. Range rate bias is expressed as a fraction of the range rate resolution specified in `RangeRateResolution`. This property sets a lower bound on the range-rate accuracy of the radar. This value is dimensionless.

Dependencies

To enable this property, set the `HasRangeRate` property to `true`.

Data Types: `double`

HasINS — Enable inertial navigation system (INS) input

`false` (default) | `true`

Enable the optional input argument that passes the current estimate of the sensor platform pose to the sensor, specified as `false` or `true`. When `true`, pose information is added to the `MeasurementParameters` structure of the reported detections. Pose information lets tracking and fusion algorithms estimate the state of the target detections in the north-east-down (NED) frame.

Data Types: `logical`

HasNoise — Enable addition of noise to radar sensor measurements

`true` (default) | `false`

Enable addition of noise to radar sensor measurements, specified as `true` or `false`. Set this property to `true` to add noise to the radar measurements. Otherwise, the measurements have no noise. Even if you set `HasNoise` to `false`, the object still computes the `MeasurementNoise` property of each detection.

Data Types: `logical`

HasFalseAlarms — Enable creating false alarm radar detections

`true` (default) | `false`

Enable creating false alarm radar measurements, specified as `true` or `false`. Set this property to `true` to report false alarms. Otherwise, only actual detections are reported.

Data Types: `logical`

HasOcclusion — Enable occlusion from extended objects

`true` (default) | `false`

Enable occlusion from extended objects, specified as `true` or `false`. Set this property to `true` to model occlusion from extended objects. Two types of occlusion (self occlusion and inter object occlusion) are modeled. Self occlusion occurs when one side of an extended object occludes another side. Inter object occlusion occurs when one extended object stands in the line of sight of another extended object or a point target. Note that both extended objects and point targets can be occluded by extended objects, but a point target cannot occlude another point target or an extended object.

Set this property to `false` to disable occlusion of extended objects. This will also disable the merging of objects whose detections share a common sensor resolution cell, which gives each object in the tracking scenario an opportunity to generate a detection.

Data Types: `logical`

MaxNumDetectionsSource — Source of maximum number of detections reported

'Auto' (default) | 'Property'

Source of maximum number of detections reported by the sensor, specified as 'Auto' or 'Property'. When this property is set to 'Auto', the sensor reports all detections. When this property is set to 'Property', the sensor reports up to the number of detections specified by the `MaxNumDetections` property.

Data Types: `char`

MaxNumDetections — Maximum number of reported detections

50 (default) | positive integer

Maximum number of detections reported by the sensor, specified as a positive integer. Detections are reported in order of distance to the sensor until the maximum number is reached.

Dependencies

To enable this property, set the `MaxNumDetectionsSource` property to 'Property'.

Data Types: `double`

DetectionCoordinates — Coordinate system of reported detections

'Body' (default) | 'Scenario' | 'Sensor rectangular' | 'Sensor spherical'

Coordinate system of reported detections, specified as:

- 'Scenario' — Detections are reported in the rectangular scenario coordinate frame. The scenario coordinate system is defined as the local NED frame at simulation start time. To enable this value, set the `HasINS` property to `true`.
- 'Body' — Detections are reported in the rectangular body system of the sensor platform.
- 'Sensor rectangular' — Detections are reported in the radar sensor rectangular body coordinate system.
- 'Sensor spherical' — Detections are reported in a spherical coordinate system derived from the sensor rectangular body coordinate system. This coordinate system is centered at the radar sensor and aligned with the orientation of the radar on the platform.

Example: 'Sensor spherical'

Data Types: `char`

HasInterference — Enable RF interference input

false (default) | true

Enable RF interference input, specified as `false` or `true`. When `true`, you can add RF interference using an input argument of the object.

Data Types: `logical`

Bandwidth — Radar waveform bandwidth

positive scalar

Radar waveform bandwidth, specified as a positive scalar. Units are in hertz.

Example: `100e3`

Data Types: `double`

CenterFrequency — Center frequency of radar band

positive scalar

Center frequency of radar band, specified as a positive scalar. Units are in hertz.

Example: `100e6`

Data Types: `double`

Sensitivity — Minimum operational sensitivity of receiver

`-50` (default) | `scalar`

Minimum operational sensitivity of receiver, specified as a scalar. Sensitivity includes isotropic antenna receiver gain. Units are in dBm.

Example: `-10`

Data Types: `double`

Usage

Syntax

```
dets = sensor(targets,simTime)
dets = sensor(targets,ins,simTime)
dets = sensor(targets,interference,simTime)
[dets,numDets,config] = sensor( ___ )
```

Description

`dets = sensor(targets,simTime)` creates radar detections, `dets`, from sensor measurements taken of `targets` at the current simulation time, `simTime`. The sensor can generate detections for multiple targets simultaneously.

`dets = sensor(targets,ins,simTime)` also specifies the INS-estimated pose information, `ins`, for the sensor platform. INS information is used by tracking and fusion algorithms to estimate the target positions in the NED frame.

To enable this syntax, set the `HasINS` property to `true`.

`dets = sensor(targets,interference,simTime)` also specifies an interference signal, `interference`.

To enable this syntax, set the `HasInterference` property to `true`.

`[dets,numDets,config] = sensor(___)` also returns the number of valid detections reported, `numDets`, and the configuration of the sensor, `config`, at the current simulation time. You can use these output arguments with any of the previous input syntaxes.

Input Arguments

targets — Tracking scenario target poses

`structure` | `structure array`

Tracking scenario target poses, specified as a structure or array of structures. Each structure corresponds to a target. You can generate this structure using the `targetPoses` method of a platform. You can also create such a structure manually. The table shows the required fields of the structure:

Field	Description
PlatformID	Unique identifier for the platform, specified as a positive integer. This is a required field with no default value.
ClassID	User-defined integer used to classify the type of target, specified as a nonnegative integer. 0 is reserved for unclassified platform types and is the default value.
Position	Position of target in platform coordinates, specified as a real-valued, 1-by-3 vector. This is a required field with no default value. Units are in meters.
Velocity	Velocity of target in platform coordinates, specified as a real-valued, 1-by-3 vector. Units are in meters per second. The default is [0 0 0].
Acceleration	Acceleration of target in platform coordinates, specified as a 1-by-3 row vector. Units are in meters per second-squared. The default is [0 0 0].
Orientation	Orientation of the target with respect to platform coordinates, specified as a scalar quaternion or a 3-by-3 rotation matrix. Orientation defines the frame rotation from the platform coordinate system to the current target body coordinate system. Units are dimensionless. The default is quaternion(1,0,0,0).
AngularVelocity	Angular velocity of the target in platform coordinates, specified as a real-valued, 1-by-3 vector. The magnitude of the vector defines the angular speed. The direction defines the axis of clockwise rotation. Units are in degrees per second. The default is [0 0 0].

The values of the Position, Velocity, and Orientation fields are defined with respect to the platform coordinate system.

simTime – Current simulation time

nonnegative scalar

Current simulation time, specified as a positive scalar. The trackingScenario object calls the scan radar sensor at regular time intervals. The radar sensor generates new detections at intervals defined by the UpdateInterval property. The value of the UpdateInterval property must be an integer multiple of the simulation time interval. Updates requested from the sensor between update intervals contain no detections. Units are in seconds.

Data Types: double

ins – Platform pose from INS

structure

Platform pose information from an inertial navigation system (INS) is a structure with these fields:

Field	Definition
Position	Position in the navigation frame, specified as a real-valued 1-by-3 vector. Units are in meters.
Velocity	Velocity in the navigation frame, specified as a real-valued 1-by-3 vector. Units are in meters per second.
Orientation	Orientation with respect to the navigation frame, specified as a quaternion or a 3-by-3 real-valued rotation matrix. The rotation is from the navigation frame to the current INS body frame. This is also referred to as a "parent to child" rotation.

Dependencies

To enable this argument, set the HasINS property to `true`.

Data Types: `struct`

interference — Interfering or jamming signal

array of `radarEmission` objects

Interfering or jamming signal, specified as an array of `radarEmission` objects.

Dependencies

To enable this argument, set the HasInterference property to `true`.

Data Types: `double`

Complex Number Support: Yes

Output Arguments

dets — sensor detections

cell array of `objectDetection` objects

Sensor detections, returned as a cell array of `objectDetection` objects. For a high level view of object detections, see `objectDetection` objects. Each object has these properties but the contents of the properties depend on the specific sensor. For the `monostaticRadarSensor`, see "Object Detections" on page 3-281.

Property	Definition
Time	Measurement time
Measurement	Object measurements
MeasurementNoise	Measurement noise covariance matrix
SensorIndex	Unique ID of the sensor
ObjectClassID	Object classification
ObjectAttributes	Additional information passed to tracker
MeasurementParameters	Parameters used by initialization functions of nonlinear Kalman tracking filters

For the `Measurement` and `MeasurementNoise` are reported in the coordinate system specified by the `DetectionCoordinates` property.

numDets — Number of detections

nonnegative integer

Number of detections reported, returned as a nonnegative integer.

- When the `MaxNumDetectionsSource` property is set to 'Auto', `numDets` is set to the length of `dets`.
- When the `MaxNumDetectionsSource` property is set to 'Property', `dets` is a cell array with length determined by the `MaxNumDetections` property. The maximum number of detections returned is `MaxNumDetections`. If the number of detections is fewer than `MaxNumDetections`, the first `numDets` elements of `dets` hold valid detections. The remaining elements of `dets` are set to the default value.

Data Types: double

config — Current sensor configuration

structure

Current sensor configuration, specified as a structure. This output can be used to determine which objects fall within the radar beam during object execution.

Field	Description
<code>SensorIndex</code>	Unique sensor index, returned as a positive integer.
<code>IsValidTime</code>	Valid detection time, returned as <code>true</code> or <code>false</code> . <code>IsValidTime</code> is <code>false</code> when detection updates are requested between update intervals specified by the update rate.
<code>IsScanDone</code>	<code>IsScanDone</code> is <code>true</code> when the sensor has completed a scan.
<code>FieldOfView</code>	Field of view of the sensor, returned as a 2-by-1 vector of positive real values, <code>[azfov;elfov]</code> . <code>azfov</code> and <code>elfov</code> represent the field of view in azimuth and elevation, respectively.
<code>MeasurementParameters</code>	Sensor measurement parameters, returned as an array of structures containing the coordinate frame transforms needed to transform positions and velocities in the top-level frame to the current sensor frame.

Data Types: struct

Object Functions

To use an object function, specify the System object as the first input argument. For example, to release system resources of a System object named `obj`, use this syntax:

```
release(obj)
```

Specific to monostaticRadarSensor

coverageConfig	Sensor and emitter coverage configuration
perturbations	Perturbation defined on object
perturb	Apply perturbations to object

Common to All System Objects

step	Run System object algorithm
release	Release resources and allow changes to System object property values and input characteristics
reset	Reset internal states of System object

Examples

Air-Traffic Control Tower Radar

Simulate a radar scenario.

```
sc = trackingScenario('UpdateRate',1);
```

Create an airport control tower with a surveillance radar located 15 meters above the ground. The radar rotates at 12.5 rpm and its field of view in azimuth is 5 degrees and its field of view in elevation is 10 degrees.

```
rpm = 12.5;
fov = [5;10]; % [azimuth; elevation]
scanrate = rpm*360/60;
updaterate = scanrate/fov(1) % Hz
```

```
updaterate = 15
```

```
radar = monostaticRadarSensor(1,'Rotator', ...
    'UpdateRate',updaterate, ...
    'MountingLocation',[0 0 -15], ...
    'MaxMechanicalScanRate',scanrate, ...
    'FieldOfView',fov, ...
    'AzimuthResolution',fov(1));
towermotion = kinematicTrajectory('SampleRate',1,'Position',[0 0 0],'Velocity',[0 0 0]);
tower = platform(sc,'ClassID',1,'Trajectory',towermotion);
aircraft1motion = kinematicTrajectory('SampleRate',1,'Position',[10000 0 1000],'Velocity',[-100 0 0]);
aircraft1 = platform(sc,'ClassID',2,'Trajectory',aircraft1motion);
aircraft2motion = kinematicTrajectory('SampleRate',1,'Position',[5000 5000 200],'Velocity',[100 0 0]);
aircraft2 = platform(sc,'ClassID',2,'Trajectory',aircraft2motion);
```

Perform 5 scans.

```
detBuffer = {};
scanCount = 0;
while advance(sc)
    simTime = sc.SimulationTime;
    targets = targetPoses(tower);
    [dets,numDets,config] = radar(targets,simTime);
    detBuffer = [detBuffer;dets];
    if config.IsScanDone
```

```

        scanCount = scanCount + 1;
        if scanCount == 5;
            break;
        end
    end
end

Plot detections

tp = theaterPlot;
clrs = lines(3);
rp = platformPlotter(tp, 'DisplayName', 'Radar', 'Marker', 's', ...
    'MarkerFaceColor', clrs(1,:));
pp = platformPlotter(tp, 'DisplayName', 'Truth', ...
    'MarkerFaceColor', clrs(2,:));
dp = detectionPlotter(tp, 'DisplayName', 'Detections', ...
    'MarkerFaceColor', clrs(3,:));
plotPlatform(rp, [0 0 0])
plotPlatform(pp, [targets(1).Position; targets(2).Position])
if ~isempty(detBuffer)
    detPos = cellfun(@(d)d.Measurement(1:3), detBuffer, ...
        'UniformOutput', false);
    detPos = cell2mat(detPos)';
    plotDetection(dp, detPos)
end

```

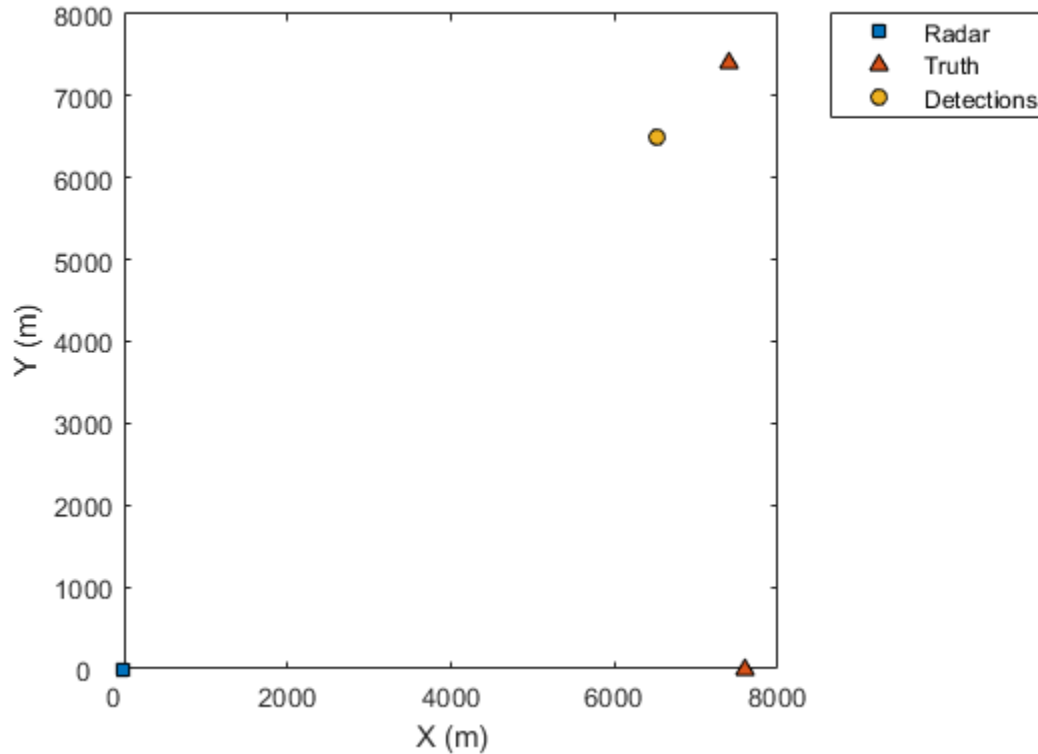

More About

Object Detections

Measurements

The sensor measures the coordinates of the target. The `Measurement` and `MeasurementNoise` values are reported in the coordinate system specified by the `DetectionCoordinates` property of the sensor.

When the `DetectionCoordinates` property is `'Scenario'`, `'Body'`, or `'Sensor rectangular'`, the `Measurement` and `MeasurementNoise` values are reported in rectangular coordinates. Velocities are only reported when the range rate property, `HasRangeRate`, is `true`.

When the `DetectionCoordinates` property is `'Sensor spherical'`, the `Measurement` and `MeasurementNoise` values are reported in a spherical coordinate system derived from the sensor rectangular coordinate system. Elevation and range rate are only reported when `HasElevation` and `HasRangeRate` are `true`.

Measurements are ordered as [azimuth, elevation, range, range rate]. Reporting of elevation and range rate depends on the corresponding `HasElevation` and `HasRangeRate` property values. Angles are in degrees, range is in meters, and range rate is in meters per second.

Measurement Coordinates

DetectionCoordinates	Measurement and Measurement Noise Coordinates		
'Scenario'	Coordinate Dependence on HasRangeRate		
'Body'	HasRangeRate	Coordinates	
'Sensor rectangular'	true	[x; y; z; vx; vy; vz]	
	false	[x; y; z]	
'Sensor spherical'	Coordinate Dependence on HasRangeRate and HasElevation		
	HasRangeRate	HasElevation	Coordinates
	true	true	[az; el; rng; rr]
	true	false	[az; rng; rr]
	false	true	[az; el; rng]
false	false	[az; rng]	

Measurement Parameters

The `MeasurementParameters` property consists of an array of structures that describe a sequence of coordinate transformations from a child frame to a parent frame or the inverse transformations (see "Frame Rotation"). In most cases, the longest required sequence of transformations is `Sensor → Platform → Scenario`.

If the detections are reported in sensor spherical coordinates and `HasINS` is set to `false`, then the sequence consists only of one transformation from sensor to platform. In the transformation, the `OriginPosition` is same as the `MountingLocation` property of the sensor. The `Orientation`

consists of two consecutive rotations. The first rotation, corresponding to the `MountingAngles` property of the sensor, accounts for the rotation from the platform frame (P) to the sensor mounting frame (M). The second rotation, corresponding to the azimuth and elevation angles of the sensor, accounts for the rotation from the sensor mounting frame (M) to the sensor scanning frame (S). In the S frame, the x direction is the boresight direction, and the y direction lies within the x - y plane of the sensor mounting frame (M).

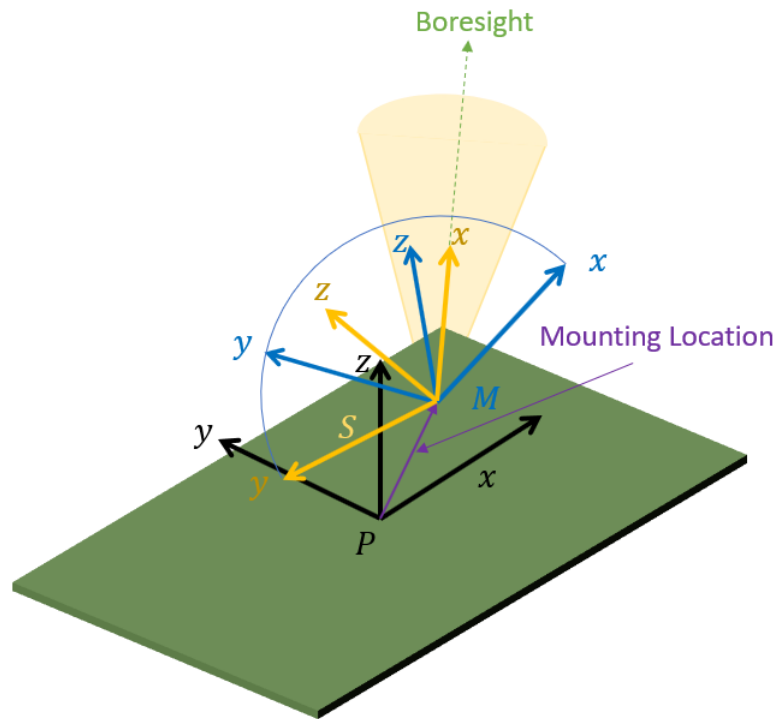

If `HasINS` is `true`, the sequence of transformations consists of two transformations - first from the scenario frame to the platform frame then from platform frame to the sensor scanning frame. In the first transformation, the `Orientation` is the rotation from the scenario frame to the platform frame, and the `OriginPosition` is the position of the platform frame origin relative to the scenario frame.

Trivially, if the detections are reported in platform rectangular coordinates and `HasINS` is set to `false`, the transformation consists only of the identity.

The fields of `MeasurementParameters` are shown here. Not all fields have to be present in the structure. The set of fields and their default values can depend on the type of sensor.

Field	Description
Frame	Enumerated type indicating the frame used to report measurements. When detections are reported using a rectangular coordinate system, Frame is set to 'rectangular'. When detections are reported in spherical coordinates, Frame is set 'spherical' for the first struct.

OriginPosition	Position offset of the origin of the child frame relative to the parent frame, represented as a 3-by-1 vector.
OriginVelocity	Velocity offset of the origin of the child frame relative to the parent frame, represented as a 3-by-1 vector.
Orientation	3-by-3 real-valued orthonormal frame rotation matrix. The direction of the rotation depends on the IsParentToChild field.
IsParentToChild	A logical scalar indicating if Orientation performs a frame rotation from the parent coordinate frame to the child coordinate frame. If false, Orientation performs a frame rotation from the child coordinate frame to the parent coordinate frame.
HasElevation	A logical scalar indicating if elevation is included in the measurement. For measurements reported in a rectangular frame, and if HasElevation is false, the measurements are reported assuming 0 degrees of elevation.
HasAzimuth	A logical scalar indicating if azimuth is included in the measurement.
HasRange	A logical scalar indicating if range is included in the measurement.
HasVelocity	A logical scalar indicating if the reported detections include velocity measurements. For measurements reported in the rectangular frame, if HasVelocity is false, the measurements are reported as [x y z]. If HasVelocity is true, measurements are reported as [x y z vx vy vz].

Object Attributes

Object attributes contain additional information about a detection:

Attribute	Description
TargetIndex	Identifier of the platform, PlatformID, that generated the detection. For false alarms, this value is negative.
SNR	Detection signal-to-noise ratio in dB.

Convenience Syntaxes

The convenience syntaxes set several properties together to model a specific type of radar.

No Scanning

Sets ScanMode to 'No scanning'.

Raster Scanning

This syntax sets these properties:

Property	Value
ScanMode	'Mechanical'
HasElevation	true
MaxMechanicalScanRate	[75;75]
MechanicalScanLimits	[-45 45; -10 0]
ElectronicScanLimits	[-45 45; -10 0]

You can change the ScanMode property to 'Electronic' to perform an electronic raster scan over the same volume as a mechanical scan.

Rotator Scanning

This syntax sets these properties:

Property	Value
ScanMode	'Mechanical'
FieldOfView	[1;10]
HasElevation	false or true
MechanicalScanLimits	[0 360; -10 0]
ElevationResolution	10/sqrt(12)

Sector Scanning

This syntax sets these properties:

Property	Value
ScanMode	'Mechanical'
FieldOfView	[1;10]
HasElevation	false
MechanicalScanLimits	[-45 45; -10 0]
ElectronicScanLimits	[-45 45; -10 0]
ElevationResolution	10/sqrt(12)

Changing the ScanMode property to 'Electronic' lets you perform an electronic raster scan over the same volume as a mechanical scan.

Compatibility Considerations**monostaticRadarSensor System object is not recommended**

The monostaticRadarSensor System object is not recommended unless you require C/C++ code generation. Instead, use the fusionRadarSensor System object. The fusionRadarSensor object provides additional properties for modeling radar sensors, including the ability to generate tracks and clustered detections. Currently, fusionRadarSensor does not support C/C++ code generation.

There are no current plans to remove the `monostaticRadarSensor` System object. MATLAB code that use this features will continue to run. In addition to the new `fusionRadarSensor` object, you can still import `monostaticRadarSensor` objects contained in a tracking scenario into the **Tracking Scenario Designer** app. Also, when you export a scenario containing `monostaticRadarSensor` objects to MATLAB code, the app exports the sensors as `fusionRadarSensor` objects.

Extended Capabilities

C/C++ Code Generation

Generate C and C++ code using MATLAB® Coder™.

Usage notes and limitations:

See “System Objects in MATLAB Code Generation” (MATLAB Coder).

See Also

Objects

`objectDetection` | `radarEmission` | `trackerGNN` | `trackerTOMHT`

Functions

`targetPoses`

Introduced in R2018b

radarSensor

Generate detections from radar emissions

Note `radarSensor` is not recommended unless you require C/C++ code generation. Use `fusionRadarSensor` instead. For more information, see “Compatibility Considerations”.

Description

The `radarSensor` System object returns a statistical model to generate detections from radar emissions. You can generate detections from monostatic radar, bistatic radar and Electronic Support Measures (ESM). You can use the `radarSensor` object in a scenario that models moving and stationary platforms using `trackingScenario`. The radar sensor can simulate real detections with added random noise and also generate false alarm detections. In addition, you can use this object to create input to trackers such as `trackerGNN`, `trackerJPDA` and `trackerTOMHT`.

This object enables you to configure a scanning radar. A scanning radar changes the look angle between updates by stepping the mechanical and electronic position of the beam in increments of the angular span specified in the `FieldOfView` property. The radar scans the total region in azimuth and elevation defined by the radar mechanical scan limits, `MechanicalScanLimits`, and electronic scan limits, `ElectronicScanLimits`. If the scanning limits for azimuth or elevation are set to `[0 0]`, then no scanning is performed along that dimension for that scan mode. If the maximum mechanical scan rate for azimuth or elevation is set to zero, then no mechanical scanning is performed along that dimension.

Using a single-exponential mode, the radar computes range and elevation biases caused by propagation through the troposphere. A range bias means that measured ranges are greater than the line-of-sight range to the target. Elevation bias means that the measured elevations are above their true elevations. Biases are larger when the line-of-sight path between the radar and target passes through lower altitudes because the atmosphere is thicker at these altitudes. See [1] and [2] for more details.

To generate radar detections:

- 1 Create the `radarSensor` object and set its properties.
- 2 Call the object with arguments, as if it were a function.

To learn more about how System objects work, see [What Are System Objects?](#).

Creation

Syntax

```
sensor = radarSensor(SensorIndex)
```

```
sensor = radarSensor(SensorIndex, 'No scanning')
```

```
sensor = radarSensor(SensorIndex, 'Raster')
```



```
sensor = radarSensor(SensorIndex, 'Rotator')
sensor = radarSensor(SensorIndex, 'Sector')

sensor = radarSensor( ___, Name, Value)
```

Description

`sensor = radarSensor(SensorIndex)` creates a radar detection generator object with a specified sensor index, `SensorIndex`, and default property values.

`sensor = radarSensor(SensorIndex, 'No_scanning')` is a convenience syntax that creates a `radarSensor` that stares along the radar antenna boresight direction. No mechanical or electronic scanning is performed. This syntax sets the `ScanMode` property to `'No_scanning'`.

`sensor = radarSensor(SensorIndex, 'Raster')` is a convenience syntax that creates a `radarSensor` object that mechanically scans a raster pattern. The raster span is 90° in azimuth from -45° to +45° and in elevation from the horizon to 10° above the horizon. See “Convenience Syntaxes” on page 3-308 for the properties set by this syntax.

`sensor = radarSensor(SensorIndex, 'Rotator')` is a convenience syntax that creates a `radarSensor` object that mechanically scans 360° in azimuth by mechanically rotating the antenna at a constant rate. When you set `HasElevation` to `true`, the radar antenna mechanically points towards the center of the elevation field of view. See “Convenience Syntaxes” on page 3-308 for the properties set by this syntax.

`sensor = radarSensor(SensorIndex, 'Sector')` is a convenience syntax to create a `radarSensor` object that mechanically scans a 90° azimuth sector from -45° to +45°. Setting `HasElevation` to `true`, points the radar antenna towards the center of the elevation field of view. You can change the `ScanMode` to `'Electronic'` to electronically scan the same azimuth sector. In this case, the antenna is not mechanically tilted in an electronic sector scan. Instead, beams are stacked electronically to process the entire elevation spanned by the scan limits in a single dwell. See “Convenience Syntaxes” on page 3-308 for the properties set by this syntax.

`sensor = radarSensor(___, Name, Value)` sets properties using one or more name-value pairs after all other input arguments. Enclose each property name in quotes. For example, `radarSensor(1, 'DetectionCoordinates', 'Sensor_cartesian', 'MaxRange', 200)` creates a radar detection generator that reports detections in the sensor Cartesian coordinate system and has a maximum detection range of 200 meters. If you specify the sensor index using the `SensorIndex` property, you can omit the `SensorIndex` input.

Properties

Unless otherwise indicated, properties are *nontunable*, which means you cannot change their values after calling the object. Objects lock when you call them, and the `release` function unlocks them.

If a property is *tunable*, you can change its value at any time.

For more information on changing property values, see System Design in MATLAB Using System Objects.

SensorIndex — Unique sensor identifier

positive integer

Unique sensor identifier, specified as a positive integer. This property distinguishes detections that come from different sensors in a multi-sensor system. When creating a `radarSensor` system object,

you must either specify the `SensorIndex` as the first input argument in the creation syntax, or specify it as the value for the `SensorIndex` property in the creation syntax.

Example: 2

Data Types: `double`

UpdateRate — Sensor update rate

1 (default) | positive scalar

Sensor update rate, specified as a positive scalar. This interval must be an integer multiple of the simulation time interval defined by `trackingScenario`. The `trackingScenario` object calls the radar sensor at simulation time intervals. The radar generates new detections at intervals defined by the reciprocal of the `UpdateRate` property. Any update requested to the sensor between update intervals contains no detections. Units are in hertz.

Example: 5

Data Types: `double`

DetectionMode — Detection mode

'ESM' (default) | 'monostatic' | 'bistatic'

Detection mode, specified as 'ESM', 'monostatic' or 'bistatic'. When set to 'ESM', the sensor operates passively and can model ESM and RWR systems. When set to 'monostatic', the sensor generates detections from reflected signals originating from a collocated radar emitter. When set to 'bistatic', the sensor generates detections from reflected signals originating from a separate radar emitter. For more details on detection mode, see “Radar Sensor Detection Modes” on page 3-303.

Example: 'Monostatic'

Data Types: `char` | `string`

EmitterIndex — Unique monostatic emitter index

positive integer

Unique monostatic emitter index, specified as a positive integer. The emitter index identifies the monostatic emitter providing the reference signal to the sensor.

Example: 404

Dependencies

To enable this property, set the `DetectionMode` property to 'Monostatic'.

Data Types: `double`

HasElevation — Enable elevation scan and measurements

false (default) | true

Enable the sensor to measure target elevation angles and to scan in elevation, specified as `false` or `true`. Set this property to `true` to model a radar sensor that can estimate target elevation and scan in elevation.

Data Types: `logical`

Sensitivity — Minimum operational sensitivity of receiver

-50 (default) | scalar

Minimum operational sensitivity of receiver, specified as a scalar. Sensitivity includes isotropic antenna receiver gain. Units are in dBm.

Example: -10

Data Types: double

DetectionThreshold — Minimum SNR required to declare a detection

5 (default) | scalar

Minimum SNR required to declare a detection, specified as a scalar. Units are in dB.

Example: -1

Data Types: double

FalseAlarmRate — False alarm rate

1e-6 (default) | positive scalar

False alarm report rate within each sensor resolution cell, specified as a positive scalar in the range of $[10^{-7}, 10^{-3}]$. Units are dimensionless. Resolution cells are determined from the AzimuthResolution and RangeResolution properties, and the ElevationResolution and RangeRateResolution properties when they are enabled.

Example: 1e-5

Data Types: double

AzimuthResolution — Azimuth resolution

1 (default) | positive scalar

Azimuth resolution of the radar, specified as a positive scalar. The azimuth resolution defines the minimum separation in azimuth angle at which the radar can distinguish two targets. The azimuth resolution is typically the 3-dB downpoint of the azimuth angle beamwidth of the radar. Units are in degrees.

Data Types: double

ElevationResolution — Elevation resolution

1 (default) | positive scalar

Elevation resolution of the radar, specified as a positive scalar. The elevation resolution defines the minimum separation in elevation angle at which the radar can distinguish two targets. The elevation resolution is typically the 3dB-downpoint in elevation angle beamwidth of the radar. Units are in degrees.

Dependencies

To enable this property, set the HasElevation property to true.

Data Types: double

AzimuthBiasFraction — Azimuth bias fraction

0.1 (default) | nonnegative scalar

Azimuth bias fraction of the radar, specified as a nonnegative scalar. The azimuth bias is expressed as a fraction of the azimuth resolution specified in AzimuthResolution. This value sets a lower bound on the azimuthal accuracy of the radar. This value is dimensionless.

Data Types: `double`

ElevationBiasFraction — Elevation bias fraction

`0.1` (default) | nonnegative scalar

Elevation bias fraction of the radar, specified as a nonnegative scalar. Elevation bias is expressed as a fraction of the elevation resolution specified by the value of the `ElevationResolution` property. This value sets a lower bound on the elevation accuracy of the radar. This value is dimensionless.

Dependencies

To enable this property, set the `HasElevation` property to `true`.

Data Types: `double`

HasINS — Enable inertial navigation system (INS) input

`false` (default) | `true`

Enable the optional input argument that passes the current estimate of the sensor platform pose to the sensor, specified as `false` or `true`. When `true`, pose information is added to the `MeasurementParameters` structure of the reported detections. Pose information lets tracking and fusion algorithms estimate the state of the target detections in the north-east-down (NED) frame.

Data Types: `logical`

HasNoise — Enable addition of noise to sensor measurements

`true` (default) | `false`

Enable addition of noise to sensor measurements, specified as `true` or `false`. Set this property to `true` to add noise to the radar measurements. Otherwise, the measurements have no noise. Even if you set `HasNoise` to `false`, the object still computes the `MeasurementNoise` property of each detection.

Data Types: `logical`

HasFalseAlarms — Enable creating false alarm detections

`true` (default) | `false`

Enable creating false alarm measurements, specified as `true` or `false`. Set this property to `true` to report false alarms. Otherwise, only actual detections are reported.

Data Types: `logical`

MaxNumDetectionsSource — Source of maximum number of detections reported

`'Auto'` (default) | `'Property'`

Source of maximum number of detections reported by the sensor, specified as `'Auto'` or `'Property'`. When this property is set to `'Auto'`, the sensor reports all detections. When this property is set to `'Property'`, the sensor reports up to the number of detections specified by the `MaxNumDetections` property.

Data Types: `char`

MaxNumDetections — Maximum number of reported detections

`50` (default) | positive integer

Maximum number of detections reported by the sensor, specified as a positive integer. If the `DetectionMode` is set to `'monostatic'` or `'bistatic'`, detections are reported in order of

distance to the sensor until the maximum number is reached. If the `DetectionMode` is set to `'ESM'`, detections are reported from highest SNR to lowest SNR.

Dependencies

To enable this property, set the `MaxNumDetectionsSource` property to `'Property'`.

Data Types: `double`

HasOcclusion — Enable occlusion from extended objects

`true` (default) | `false`

Enable occlusion from extended objects, specified as `true` or `false`. Set this property to `true` to model occlusion from extended objects. Two types of occlusion (self occlusion and inter object occlusion) are modeled. Self occlusion occurs when one side of an extended object occludes another side. Inter object occlusion occurs when one extended object stands in the line of sight of another extended object or a point target. Note that both extended objects and point targets can be occluded by extended objects, but a point target cannot occlude another point target or an extended object.

Set this property to `false` to disable occlusion of extended objects. This will also disable the merging of objects whose detections share a common sensor resolution cell, which gives each object in the tracking scenario an opportunity to generate a detection.

Data Types: `logical`

DetectionCoordinates — Coordinate system of reported detections

`'Scenario'` | `'Body'` | `'Sensor rectangular'` | `'Sensor spherical'`

Coordinate system of reported detections, specified as:

- `'Scenario'` — Detections are reported in the rectangular scenario coordinate frame. The scenario coordinate system is defined as the local NED frame at simulation start time. To enable this value, set the `HasINS` property to `true`.
- `'Body'` — Detections are reported in the rectangular body system of the sensor platform.
- `'Sensor rectangular'` — Detections are reported in the sensor rectangular body coordinate system.
- `'Sensor spherical'` — Detections are reported in a spherical coordinate system derived from the sensor rectangular body coordinate system. This coordinate system is centered at the sensor and aligned with the orientation of the radar on the platform.

When the `DetectionMode` property is set to `'monostatic'`, you can specify the `DetectionCoordinates` as `'Body'` (default for `'monostatic'`), `'Scenario'`, `'Sensor rectangular'`, or `'Sensor spherical'`. When the `DetectionMode` property is set to `'ESM'` or `'bistatic'`, the default value of the `DetectionCoordinates` property is `'Sensor spherical'`, which can not be changed.

Example: `'Sensor spherical'`

Data Types: `char`

ESM and Bistatic Sensor Properties

MountingLocation — Sensor location on platform

`[0 0 0]` (default) | 1-by-3 real-valued vector

Sensor location on platform, specified as a 1-by-3 real-valued vector. This property defines the coordinates of the sensor with respect to the platform origin. The default value specifies that the sensor origin is at the origin of its platform. Units are in meters.

Example: `[.2 0.1 0]`

Dependencies

To enable this property, set the `DetectionMode` property to 'ESM' or 'bistatic'.

Data Types: double

MountingAngles — Orientation of sensor

`[0 0 0]` (default) | 3-element real-valued vector

Orientation of the sensor with respect to the platform, specified as a three-element real-valued vector. Each element of the vector corresponds to an intrinsic Euler angle rotation that carries the body axes of the platform to the sensor axes. The three elements define the rotations around the *z*-, *y*-, and *x*-axes, in that order. The first rotation rotates the platform axes around the *z*-axis. The second rotation rotates the carried frame around the rotated *y*-axis. The final rotation rotates the frame around the carried *x*-axis. Units are in degrees.

Example: `[10 20 -15]`

Dependencies

To enable this property, set the `DetectionMode` property to 'ESM' or 'bistatic'.

Data Types: double

FieldOfView — Fields of view of sensor

`[10;50]` | 2-by-1 vector of positive scalar

Fields of view of sensor, specified as a 2-by-1 vector of positive scalars in degree, `[azfov;elfov]`. The field of view defines the total angular extent spanned by the sensor. The azimuth field of view `azfov` must lie in the interval (0,360]. The elevation field of view `elfov` must lie in the interval (0,180].

Example: `[14;7]`

Data Types: double

ScanMode — Scanning mode of radar

'Mechanical' (default) | 'Electronic' | 'Mechanical and electronic' | 'No scanning'

Scanning mode of radar, specified as 'Mechanical', 'Electronic', 'Mechanical and electronic', or 'No scanning'.

Scan Modes

ScanMode	Purpose
'Mechanical'	The sensor scans mechanically across the azimuth and elevation limits specified by the <code>MechanicalScanLimits</code> property. The scan direction increments by the radar field of view angle between dwells.
'Electronic'	The sensor scans electronically across the azimuth and elevation limits specified by the <code>ElectronicScanLimits</code> property. The scan direction increments by the radar field of view angle between dwells.
'Mechanical and electronic'	The sensor mechanically scans the antenna boresight across the mechanical scan limits and electronically scans beams relative to the antenna boresight across the electronic scan limits. The total field of regard scanned in this mode is the combination of the mechanical and electronic scan limits. The scan direction increments by the radar field of view angle between dwells.
'No scanning'	The sensor beam points along the antenna boresight defined by the <code>mountingAngles</code> property.

Example: 'No scanning'

Dependencies

To enable this property, set the `DetectionMode` property to 'ESM' or 'bistatic'.

Data Types: char

MaxMechanicalScanRate — Maximum mechanical scan rate

[75;75] (default) | nonnegative scalar | real-valued 2-by-1 vector with nonnegative entries

Maximum mechanical scan rate, specified as a nonnegative scalar or real-valued 2-by-1 vector with nonnegative entries.

When `HasElevation` is `true`, specify the scan rate as a 2-by-1 column vector of nonnegative entries [`maxAzRate`; `maxElRate`]. `maxAzRate` is the maximum scan rate in azimuth and `maxElRate` is the maximum scan rate in elevation.

When `HasElevation` is `false`, specify the scan rate as a nonnegative scalar representing the maximum mechanical azimuth scan rate.

Scan rates set the maximum rate at which the sensor can mechanically scan. The sensor sets its scan rate to step the radar mechanical angle by the field of regard. If the required scan rate exceeds the maximum scan rate, the maximum scan rate is used. Units are degrees per second.

Example: [5;10]

Dependencies

To enable this property, set the `ScanMode` property to 'Mechanical' or 'Mechanical and electronic', and set the `DetectionMode` property to 'ESM' or 'bistatic'.

Data Types: double

MechanicalScanLimits — Angular limits of mechanical scan directions of radar

[0 360; -10 0] (default) | real-valued 1-by-2 row vector | real-valued 2-by-2 matrix

Angular limits of mechanical scan directions of radar, specified as a real-valued 1-by-2 row vector, or a real-valued 2-by-2 matrix. The mechanical scan limits define the minimum and maximum mechanical angles the radar can scan from its mounted orientation.

When `HasElevation` is `true`, the scan limits take the form [minAz maxAz; minEl maxEl]. `minAz` and `maxAz` represent the minimum and maximum limits of the azimuth angle scan. `minEl` and `maxEl` represent the minimum and maximum limits of the elevation angle scan. When `HasElevation` is `false`, the scan limits take the form [minAz maxAz]. If you specify the scan limits as a 2-by-2 matrix but set `HasElevation` to `false`, the second row of the matrix is ignored.

Azimuthal scan limits cannot span more than 360° and elevation scan limits must lie within the closed interval [-90° 90°]. Units are in degrees.

Example: [-90 90; 0 85]

Dependencies

To enable this property, set the `ScanMode` property to 'Mechanical' or 'Mechanical and electronic', and set the `DetectionMode` property to 'ESM' or 'bistatic'.

Data Types: double

MechanicalAngle — Current mechanical scan angle

scalar | real-valued 2-by-1 vector

This property is read-only.

Current mechanical scan angle of radar, returned as a scalar or real-valued 2-by-1 vector. When `HasElevation` is `true`, the scan angle takes the form [Az; El]. `Az` and `El` represent the azimuth and elevation scan angles, respectively, relative to the mounted angle of the radar on the platform. When `HasElevation` is `false`, the scan angle is a scalar representing the azimuth scan angle.

Dependencies

To enable this property, set the `ScanMode` property to 'Mechanical' or 'Mechanical and electronic', and set the `DetectionMode` property to 'ESM' or 'bistatic'.

Data Types: double

ElectronicScanLimits — Angular limits of electronic scan directions of radar

[-45 45; -45 45] (default) | real-valued 1-by-2 row vector | real-valued 2-by-2 matrix

Angular limits of electronic scan directions of radar, specified as a real-valued 1-by-2 row vector, or a real-valued 2-by-2 matrix. The electronic scan limits define the minimum and maximum electronic angles the radar can scan from its current mechanical direction.

When `HasElevation` is `true`, the scan limits take the form [minAz maxAz; minEl maxEl]. `minAz` and `maxAz` represent the minimum and maximum limits of the azimuth angle scan. `minEl` and `maxEl`

represent the minimum and maximum limits of the elevation angle scan. When `HasElevation` is `false`, the scan limits take the form `[minAz maxAz]`. If you specify the scan limits as a 2-by-2 matrix but set `HasElevation` to `false`, the second row of the matrix is ignored.

Azimuthal scan limits and elevation scan limits must lie within the closed interval `[-90° 90°]`. Units are in degrees.

Example: `[-90 90;0 85]`

Dependencies

To enable this property, set the `ScanMode` property to `'Electronic'` or `'Mechanical and electronic'`, and set the `DetectionMode` property to `'ESM'` or `'bistatic'`.

Data Types: `double`

ElectronicAngle — Current electronic scan angle

electronic scalar | nonnegative scalar

This property is read-only.

Current electronic scan angle of radar, returned as a scalar or 1-by-2 column vector. When `HasElevation` is `true`, the scan angle takes the form `[Az;El]`. `Az` and `El` represent the azimuth and elevation scan angles, respectively. When `HasElevation` is `false`, the scan angle is a scalar representing the azimuth scan angle.

Dependencies

To enable this property, set the `ScanMode` property to `'Electronic'` or `'Mechanical and electronic'`, and set the `DetectionMode` property to `'ESM'` or `'bistatic'`.

Data Types: `double`

LookAngle — Look angle of sensor

scalar | real-valued 2-by-1 vector

This property is read-only.

Look angle of sensor, specified as a scalar or real-valued 2-by-1 vector. Look angle is a combination of the mechanical angle and electronic angle depending on the `ScanMode` property.

ScanMode	LookAngle
'Mechanical'	MechanicalAngle
'Electronic'	ElectronicAngle
'Mechanical and Electronic'	MechanicalAngle + ElectronicAngle
'No scanning'	0

When `HasElevation` is `true`, the look angle takes the form `[Az;El]`. `Az` and `El` represent the azimuth and elevation look angles, respectively. When `HasElevation` is `false`, the look angle is a scalar representing the azimuth look angle.

Dependencies

To enable this property, set the `DetectionMode` property to `'ESM'` or `'bistatic'`.

CenterFrequency — Center frequency of radar band

positive scalar

Center frequency of radar band, specified as a positive scalar. Units are in hertz.

Example: 100e6

Dependencies

To enable this property, set the `DetectionMode` property to 'ESM' or 'bistatic'.

Data Types: double

Bandwidth — Radar waveform bandwidth

positive scalar

Radar waveform bandwidth, specified as a positive scalar. Units are in hertz.

Example: 100e3

Dependencies

To enable this property, set the `DetectionMode` property to 'ESM' or 'bistatic'.

Data Types: double

WaveformTypes — Types of detected waveforms0 (default) | nonnegative integer-valued L -element vector

Types of detected waveforms, specified as a nonnegative integer-valued L -element vector.

Example: [1 4 5]

Dependencies

To enable this property, set the `DetectionMode` property to 'ESM' or 'bistatic'.

Data Types: double

ConfusionMatrix — Probability of correct classification of detected waveformpositive scalar | real-valued nonnegative L -element vector | real-valued nonnegative L -by- L matrix

Probability of correct classification of a detected waveform, specified as a positive scalar, a real-valued nonnegative L -element vector, or a real-valued nonnegative L -by- L matrix. Matrix values lie from 0 through 1 and matrix rows must sum to 1. L is the number of waveform types detectable by the sensor, as indicated by the value set in the `WaveformTypes` property. The (i,j) matrix element represents the probability of classifying the i th waveform as the j th waveform. When specified as a scalar from 0 through 1, the value is expanded along the diagonal of the confusion matrix. When specified as a vector, it must have the same number of elements as the `WaveformTypes` property. When defined as a scalar or a vector, the off diagonal values are set to $(1-\text{val})/(L-1)$.

Dependencies

To enable this property, set the `DetectionMode` property to 'ESM' or 'bistatic'.

Data Types: double

Monostatic and Bistatic Sensor Properties**RangeResolution — Range resolution of radar**

100 (default) | positive scalar

Range resolution of the radar, specified as a positive scalar. The range resolution defines the minimum separation in range at which the radar can distinguish between two targets. Units are in meters.

Dependencies

To enable this property, set the `DetectionMode` property to `'monostatic'` or `'bistatic'`.

Data Types: `double`

RangeRateResolution — Range rate resolution of radar

10 (default) | positive scalar

Range rate resolution of the radar, specified as a positive scalar. The range rate resolution defines the minimum separation in range rate at which the radar can distinguish between two targets. Units are in meters per second.

Dependencies

To enable this property, set the `HasRangeRate` property to `true`, and set the `DetectionMode` property to `'monostatic'` or `'bistatic'`.

Data Types: `double`

RangeBiasFraction — Range bias fraction

0.05 (default) | nonnegative scalar

Range bias fraction of the radar, specified as a nonnegative scalar. Range bias is expressed as a fraction of the range resolution specified in `RangeResolution`. This property sets a lower bound on the range accuracy of the radar. This value is dimensionless.

Dependencies

To enable this property, set the `DetectionMode` property to `'monostatic'` or `'bistatic'`.

Data Types: `double`

RangeRateBiasFraction — Range rate bias fraction

0.05 (default) | nonnegative scalar

Range rate bias fraction of the radar, specified as a nonnegative scalar. Range rate bias is expressed as a fraction of the range rate resolution specified in `RangeRateResolution`. This property sets a lower bound on the range-rate accuracy of the radar. This value is dimensionless.

Dependencies

To enable this property, set the `HasRangeRate` property to `true`, and set the `DetectionMode` property to `'monostatic'` or `'bistatic'`.

Data Types: `double`

HasRangeRate — Enable radar to measure range rate

false (default) | true

Enable the radar to measure target range rates, specified as `false` or `true`. Set this property to `true` to model a radar sensor that can measure target range rate. Set this property to `false` to model a radar sensor that cannot measure range rate.

Dependencies

To enable this property, set the `DetectionMode` property to 'ESM' or 'bistatic'.

Data Types: `logical`

HasRangeAmbiguities — Enable range ambiguities

`false` (default) | `true`

Enable range ambiguities, specified as `false` or `true`. Set this property to `true` to enable range ambiguities by the sensor. In this case, the sensor cannot resolve range ambiguities for targets at ranges beyond the `MaxUnambiguousRange` are wrapped into the interval `[0, MaxUnambiguousRange]`. When `false`, targets are reported at their unambiguous range.

Dependencies

To enable this property, set the `DetectionMode` property to 'ESM' or 'bistatic'.

Data Types: `logical`

HasRangeRateAmbiguities — Enable range-rate ambiguities

`false` (default) | `true`

Enable range-rate ambiguities, specified as `false` or `true`. Set to `true` to enable range-rate ambiguities by the sensor. When `true`, the sensor does not resolve range rate ambiguities and target range rates beyond the `MaxUnambiguousRadialSpeed` are wrapped into the interval `[0, MaxUnambiguousRadialSpeed]`. When `false`, targets are reported at their unambiguous range rate.

Dependencies

To enable this property, set the `HasRangeRate` property to `true` and set the `DetectionMode` property to 'ESM' or 'bistatic'.

Data Types: `logical`

MaxUnambiguousRange — Maximum unambiguous detection range

`100e3` (default) | positive scalar

Maximum unambiguous range, specified as a positive scalar. Maximum unambiguous range defines the maximum range for which the radar can unambiguously resolve the range of a target. When `HasRangeAmbiguities` is set to `true`, targets detected at ranges beyond the maximum unambiguous range are wrapped into the range interval `[0, MaxUnambiguousRange]`. This property applies to true target detections when you set the `HasRangeAmbiguities` property to `true`.

This property also applies to false target detections when you set the `HasFalseAlarms` property to `true`. In this case, the property defines the maximum range for false alarms.

Units are in meters.

Example: `5e3`

Dependencies

To enable this property, set the `HasRangeAmbiguities` property or the `HasFalseAlarms` property to `true`. Meanwhile, set the `DetectionMode` property to 'ESM' or 'bistatic'.

Data Types: `double`

MaxUnambiguousRadialSpeed — Maximum unambiguous radial speed

200 (default) | positive scalar

Maximum unambiguous radial speed, specified as a positive scalar. Radial speed is the magnitude of the target range rate. Maximum unambiguous radial speed defines the radial speed for which the radar can unambiguously resolve the range rate of a target. When `HasRangeRateAmbiguities` is set to `true`, targets detected at range rates beyond the maximum unambiguous radial speed are wrapped into the range rate interval `[-MaxUnambiguousRadialSpeed, MaxUnambiguousRadialSpeed]`. This property applies to true target detections when you set `HasRangeRateAmbiguities` property to `true`.

This property also applies to false target detections obtained when you set both the `HasRangeRate` and `HasFalseAlarms` properties to `true`. In this case, the property defines the maximum radial speed for which false alarms can be generated.

Units are in meters per second.

Dependencies

To enable this property, set `HasRangeRate` and `HasRangeRateAmbiguities` to `true` and/or set `HasRangeRate` and `HasFalseAlarms` to `true`. Meanwhile, set the `DetectionMode` property to 'ESM' or 'bistatic'.

Data Types: double

Usage**Syntax**

```
dets = sensor(radarsigs,simTime)
dets = sensor(radarsigs,txconfigs,simTime)
dets = sensor(___,ins,simTime)
[dets,numDets,config] = sensor(___)
```

Description

`dets = sensor(radarsigs,simTime)` creates ESM or bistatic radar detections, `dets`, from radar emissions, `radarsigs`, at the current simulation time, `simTime`. The sensor generates detections at the rate defined by the `UpdateRate` property. To use this syntax, set `ScanMode` property to 'ESM' or 'bistatic'.

`dets = sensor(radarsigs,txconfigs,simTime)` also specifies emitter configurations, `txconfigs`, of the monostatic sensor at the current simulation time. To use this syntax, set `ScanMode` property to 'Monostatic'.

`dets = sensor(___,ins,simTime)` also specifies the inertial navigation system (INS) estimated sensor platform pose, `ins`. INS information is used by tracking and fusion algorithms to estimate the target positions in the NED frame.

To use this syntax, set the `HasINS` property to `true`.

`[dets,numDets,config] = sensor(___)` also returns the number of valid detections reported, `numDets`, and the configuration of the sensor, `config`, at the current simulation time.

Input Arguments

radarsigs — Radar emissions

array of radar emission objects

Radar emissions, specified as an array or a cell array of radarEmission objects.

txconfigs — Emitter configurations

array of structures

Emitter configurations, specified as an array of structures. This array must contain the configuration of the radarEmitter whose EmitterIndex matches the value of the EmitterIndex property of the radarSensor. Each structure has these fields:

Field	Description
EmitterIndex	Unique emitter index
IsValidTime	Valid emission time, returned as 0 or 1. IsValidTime is 0 when emitter updates are requested at times that are between update intervals specified by UpdateInterval.
IsScanDone	IsScanDone is true when the emitter has completed a scan.
FieldOfView	Field of view of emitter.
MeasurementParameters	MeasurementParameters is an array of structures containing the coordinate frame transforms needed to transform positions and velocities in the top-level frame to the current emitter frame.

For more details on MeasurementParameters, see “Measurement Parameters” on page 3-305.

Data Types: struct

ins — Platform pose from INS

structure

Platform pose information from an inertial navigation system (INS) is a structure with these fields:

Field	Definition
Position	Position in the navigation frame, specified as a real-valued 1-by-3 vector. Units are in meters.
Velocity	Velocity in the navigation frame, specified as a real-valued 1-by-3 vector. Units are in meters per second.
Orientation	Orientation with respect to the navigation frame, specified as a quaternion or a 3-by-3 real-valued rotation matrix. The rotation is from the navigation frame to the current INS body frame. This is also referred to as a “parent to child” rotation.

Dependencies

To enable this argument, set the `HasINS` property to `true`.

Data Types: `struct`

simTime — Current simulation time

nonnegative scalar

Current simulation time, specified as a positive scalar. The `trackingScenario` object calls the scan radar sensor at regular time intervals. The radar sensor generates new detections at intervals defined by the `UpdateInterval` property. The value of the `UpdateInterval` property must be an integer multiple of the simulation time interval. Updates requested from the sensor between update intervals contain no detections. Units are in seconds.

Example: 10.5

Data Types: `double`

Output Arguments**dets — sensor detections**

cell array of `objectDetection` objects

Sensor detections, returned as a cell array of `objectDetection` objects. Each object has these properties:

Property	Definition
Time	Measurement time
Measurement	Object measurements
MeasurementNoise	Measurement noise covariance matrix
SensorIndex	Unique ID of the sensor
ObjectClassID	Object classification
ObjectAttributes	Additional information passed to tracker
MeasurementParameters	Parameters used by initialization functions of nonlinear Kalman tracking filters

Measurement and MeasurementNoise are reported in the coordinate system specified by the `DetectionCoordinates` property. For details on Measurement, MeasurementParameters, and ObjectAttributes of `radarSensor`, please see “Object Detections” on page 3-304.

numDets — Number of detections

nonnegative integer

Number of detections reported, returned as a nonnegative integer.

- When the `MaxNumDetectionsSource` property is set to 'Auto', `numDets` is set to the length of `dets`.
- When the `MaxNumDetectionsSource` property is set to 'Property', `dets` is a cell array with length determined by the `MaxNumDetections` property. No more than `MaxNumDetections` number of detections are returned. If the number of detections is fewer than `MaxNumDetections`, the first `numDets` elements of `dets` hold valid detections. The remaining elements of `dets` are set to the default value.

Data Types: `double`

config – Current sensor configuration
structure

Current sensor configuration, specified as a structure. This output can be used to determine which objects fall within the radar beam during object execution.

Field	Description
SensorIndex	Unique sensor index, returned as a positive integer.
IsValidTime	Valid detection time, returned as <code>true</code> or <code>false</code> . <code>IsValidTime</code> is <code>false</code> when detection updates are requested between update intervals specified by the update rate.
IsScanDone	<code>IsScanDone</code> is <code>true</code> when the sensor has completed a scan.
FieldOfView	Field of view of the sensor, returned as a 2-by-1 vector of positive real values, <code>[azfov;elfov]</code> . <code>azfov</code> and <code>elfov</code> represent the field of view in azimuth and elevation, respectively.
MeasurementParameters	Sensor measurement parameters, returned as an array of structures containing the coordinate frame transforms needed to transform positions and velocities in the top-level frame to the current sensor frame.

Data Types: `struct`

Object Functions

To use an object function, specify the System object as the first input argument. For example, to release system resources of a System object named `obj`, use this syntax:

`release(obj)`

Specific to radarSensor

`coverageConfig` Sensor and emitter coverage configuration
`perturbations` Perturbation defined on object
`perturb` Apply perturbations to object

Common to All System Objects

`step` Run System object algorithm
`release` Release resources and allow changes to System object property values and input characteristics
`reset` Reset internal states of System object

Examples

Detect Radar Emission with fusionRadarSensor

Create an radar emission and then detect the emission using a fusionRadarSensor object.

First, create an radar emission.

```
orient = quaternion([180 0 0], 'eulerd', 'zyx', 'frame');
rfSig = radarEmission('PlatformID',1,'EmitterIndex',1,'EIRP',100, ...
    'OriginPosition',[30 0 0],'Orientation',orient);
```

Then, create an ESM sensor using fusionRadarSensor.

```
sensor = fusionRadarSensor(1,'DetectionMode','ESM');
```

Detect the RF emission.

```
time = 0;
[dets,numDets,config] = sensor(rfSig,time)

dets = 1x1 cell array
    {1x1 objectDetection}

numDets = 1

config = struct with fields:
    SensorIndex: 1
    IsValidTime: 1
    IsScanDone: 0
    FieldOfView: [1 5]
    MeasurementParameters: [1x1 struct]
```

More About

Radar Sensor Detection Modes

The radarSensor system object can model three detection modes: monostatic, bistatic, and electronic support measures (ESM) as shown in the following figures.

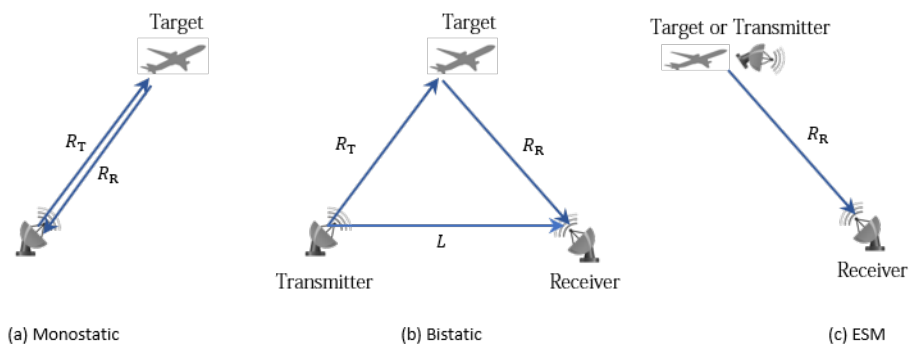

For the monostatic detection mode, the transmitter and the receiver are collocated, as shown in figure (a). In this mode, the range measurement R can be expressed as $R = R_T = R_R$, where R_T and R_R are the ranges from the transmitter to the target and from the target to the receiver, respectively. In

the radar sensor, the range measurement is $R = ct/2$, where c is the speed of light and t is the total time of the signal transmission. Other than the range measurement, a monostatic sensor can also optionally report range rate, azimuth, and elevation measurements of the target.

For the bistatic detection mode, the transmitter and the receiver are separated by a distance L . As shown in figure (b), the signal is emitted from the transmitter, reflected from the target, and eventually received by the receiver. The bistatic range measurement R_b is defined as $R_b = R_T + R_R - L$. In the radar sensor, the bistatic range measurement is obtained by $R_b = c\Delta t$, where Δt is the time difference between the receiver receiving the direct signal from the transmitter and receiving the reflected signal from the target. Other than the bistatic range measurement, a bistatic sensor can also optionally report bistatic range rate, azimuth, and elevation measurements of the target. Since the bistatic range and the two bearing angles (azimuth and elevation) do not correspond to the same position vector, they cannot be combined into a position vector and reported in a Cartesian coordinate system. As a result, the measurements of a bistatic sensor can only be reported in a spherical coordinate system.

For the ESM detection mode, the receiver can only receive a signal reflected from the target or directly emitted from the transmitter, as shown in figure (c). Therefore, the only available measurements are azimuth and elevation of the target or transmitter. These measurements can only be reported in a spherical coordinate system.

Object Detections

Measurements

The sensor measures the coordinates of the target. The `Measurement` and `MeasurementNoise` values are reported in the coordinate system specified by the `DetectionCoordinates` property of the sensor.

When the `DetectionCoordinates` property is `'Scenario'`, `'Body'`, or `'Sensor rectangular'`, the `Measurement` and `MeasurementNoise` values are reported in rectangular coordinates. Velocities are only reported when the range rate property, `HasRangeRate`, is `true`.

When the `DetectionCoordinates` property is `'Sensor spherical'`, the `Measurement` and `MeasurementNoise` values are reported in a spherical coordinate system. Measurements are ordered as [azimuth, elevation, range, range rate]. Angles are in degrees, range is in meters, and range rate is in meters per second. Elevation and range rate are only reported when `HasElevation` and `HasRangeRate` are `true`.

Note:

- When the `DetectionMode` is set to `'ESM'` or `'bistatic'`, the detections can only be reported in `'Sensor spherical'` coordinate system.
- When the `DetectionMode` is set to `'monostatic'`, the reported `'range'` is the range measurement from the target to the radar sensor.
- When the `DetectionMode` is set to `'bistatic'`, the reported `'range'` is the bistatic range measurement (see “Radar Sensor Detection Modes” on page 3-303).

Measurement Coordinates

DetectionCoordinates	Measurement and Measurement Noise Coordinates		
'Scenario'	Coordinate Dependence on HasRangeRate		
'Body'	HasRangeRate	Coordinates	
'Sensor rectangular'	true	[x; y; z; vx; vy; vz]	
	false	[x; y; z]	
'Sensor spherical'	Coordinate for 'monostatic' or 'bistatic' Detection Mode (Dependence on HasRangeRate and HasElevation)		
	HasRangeRate	HasElevation	Coordinates
	true	true	[az; el; rng; rr]
	true	false	[az; rng; rr]
	false	true	[az; el; rng]
	false	false	[az; rng]
	Coordinate for 'ESM' Detection Mode (Dependence on HasElevation)		
	HasElevation	Coordinates	
	true	[az; el]	
	false	[az]	

where az, el, rng and rr represent azimuth angle, elevation angle, range and range rate, respectively.

Measurement Parameters

The `MeasurementParameters` property consists of an array of structures that describe a sequence of coordinate transformations from a child frame to a parent frame or the inverse transformations (see "Frame Rotation"). In most cases, the longest required sequence of transformations is Sensor → Platform → Scenario.

If the detections are reported in sensor spherical coordinates and `HasINS` is set to `false`, then the sequence consists only of one transformation from sensor to platform. In the transformation, the `OriginPosition` is same as the `MountingLocation` property of the sensor. The `Orientation` consists of two consecutive rotations. The first rotation, corresponding to the `MountingAngles` property of the sensor, accounts for the rotation from the platform frame (P) to the sensor mounting frame (M). The second rotation, corresponding to the azimuth and elevation angles of the sensor, accounts for the rotation from the sensor mounting frame (M) to the sensor scanning frame (S). In the S frame, the x direction is the boresight direction, and the y direction lies within the x - y plane of the sensor mounting frame (M).

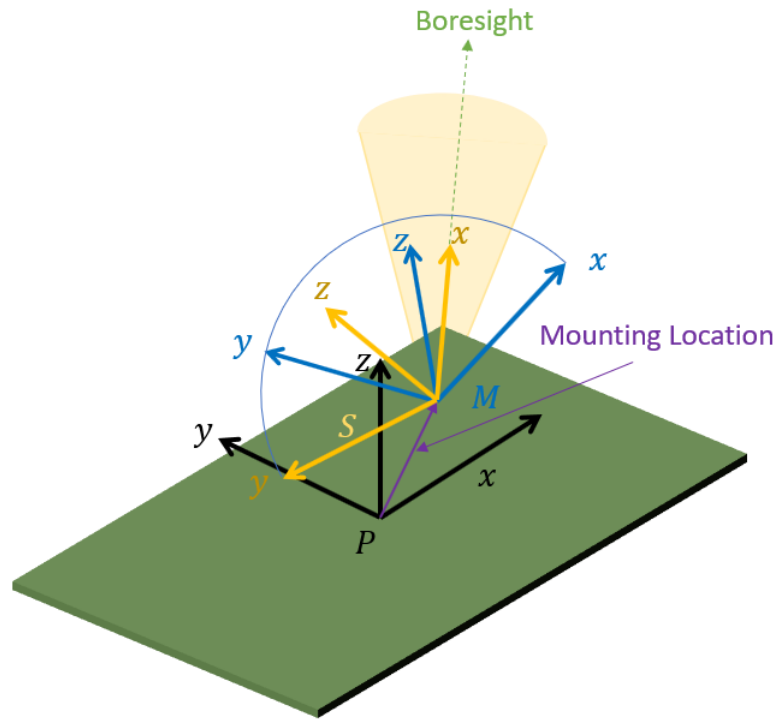

If `HasINS` is `true`, the sequence of transformations consists of two transformations - first from the scenario frame to the platform frame then from platform frame to the sensor scanning frame. In the first transformation, the `Orientation` is the rotation from the scenario frame to the platform frame, and the `OriginPosition` is the position of the platform frame origin relative to the scenario frame.

Trivially, if the detections are reported in platform rectangular coordinates and `HasINS` is set to `false`, the transformation consists only of the identity.

The fields of `MeasurementParameters` are shown here. Not all fields have to be present in the structure. The set of fields and their default values can depend on the type of sensor.

Field	Description
Frame	Enumerated type indicating the frame used to report measurements. When detections are reported using a rectangular coordinate system, Frame is set to 'rectangular'. When detections are reported in spherical coordinates, Frame is set 'spherical' for the first struct.
OriginPosition	Position offset of the origin of the child frame relative to the parent frame, represented as a 3-by-1 vector.
OriginVelocity	Velocity offset of the origin of the child frame relative to the parent frame, represented as a 3-by-1 vector.

Orientation	3-by-3 real-valued orthonormal frame rotation matrix. The direction of the rotation depends on the IsParentToChild field.
IsParentToChild	A logical scalar indicating if Orientation performs a frame rotation from the parent coordinate frame to the child coordinate frame. If false, Orientation performs a frame rotation from the child coordinate frame to the parent coordinate frame.
HasElevation	A logical scalar indicating if elevation is included in the measurement. For measurements reported in a rectangular frame, and if HasElevation is false, the measurements are reported assuming 0 degrees of elevation.
HasAzimuth	A logical scalar indicating if azimuth is included in the measurement.
HasRange	A logical scalar indicating if range is included in the measurement.
HasVelocity	A logical scalar indicating if the reported detections include velocity measurements. For measurements reported in the rectangular frame, if HasVelocity is false, the measurements are reported as [x y z]. If HasVelocity is true, measurements are reported as [x y z vx vy vz].

Object Attributes

Object attributes contain additional information about a detection.

Attribute	Description
TargetIndex	Identifier of the platform, PlatformID, that generated the detection. For false alarms, this value is negative.
EmitterIndex	Index of the emitter from which the detected signal was emitted.
SNR	Detection signal-to-noise ratio in dB.
CenterFrequency	<ul style="list-style-type: none"> Measured center frequency of the detected radar signal. Units are in Hz. This attribute is present only when the DetectionMode property is set to 'ESM' or 'Bistatic'.
Bandwidth	<ul style="list-style-type: none"> Measured bandwidth of the detected radar signal, Units are in Hz. This attribute is present only when the DetectionMode property is set to 'ESM' or 'Bistatic'.

WaveformType	<ul style="list-style-type: none"> Identifier of the waveform type that was classified by the ESM sensor for the detected signal. This attribute is present only when the DetectionMode property is set to 'ESM' or 'Bistatic'.
--------------	---

Convenience Syntaxes

The convenience syntaxes set several properties together to model a specific type of radar.

No Scanning

Sets ScanMode to 'No scanning'.

Raster Scanning

This syntax sets these properties:

Property	Value
ScanMode	'Mechanical'
HasElevation	true
MaxMechanicalScanRate	[75;75]
MechanicalScanLimits	[-45 45; -10 0]
ElectronicScanLimits	[-45 45; -10 0]

You can change the ScanMode property to 'Electronic' to perform an electronic raster scan over the same volume as a mechanical scan.

Rotator Scanning

This syntax sets these properties:

Property	Value
ScanMode	'Mechanical'
FieldOfView	[1;10]
HasElevation	false or true
MechanicalScanLimits	[0 360; -10 0]
ElevationResolution	10/sqrt(12)

Sector Scanning

This syntax sets these properties:

Property	Value
ScanMode	'Mechanical'
FieldOfView	[1;10]
HasElevation	false

MechanicalScanLimits	[-45 45; -10 0]
ElectronicScanLimits	[-45 45; -10 0]
ElevationResolution	10/sqrt(12)

Changing the ScanMode property to 'Electronic' lets you perform an electronic raster scan over the same volume as a mechanical scan.

Compatibility Considerations

radarSensor System object is not recommended

The radarSensor System object is not recommended unless you require C/C++ code generation. Instead, use the fusionRadarSensor System object. Currently, fusionRadarSensor does not support C/C++ code generation.

There are no current plans to remove the radarSensor System object. MATLAB code that use this features will continue to run.

References

- [1] Doerry, A. W. "Earth curvature and atmospheric refraction effects on radar signal propagation." *Sandia Report* . SAND 2012-10690, 2013.
- [2] Doerry, A. W. "Motion Measurement for Synthetic Aperture Radar." *Sandia Report* . SAND 2015-20818, 2015.

Extended Capabilities

C/C++ Code Generation

Generate C and C++ code using MATLAB® Coder™.

Usage notes and limitations:

See "System Objects in MATLAB Code Generation" (MATLAB Coder).

See Also

Objects

monostaticRadarSensor | objectDetection | radarEmission | trackerGNN | trackerTOMHT

Functions

targetPoses

Introduced in R2018b

radarEmitter

Radar signals and interferences generator

Description

The `radarEmitter` System object creates an emitter to simulate radar emissions. You can use the `radarEmitter` object in a scenario that detects and tracks moving and stationary platforms. Construct a scenario using `trackingScenario`.

A radar emitter changes the look angle between updates by stepping the mechanical and electronic position of the beam in increments of the angular span specified in the `FieldOfView` property. The radar scans the total region in azimuth and elevation defined by the radar mechanical and electronic scan limits, `MechanicalScanLimits` and `ElectronicScanLimits`, respectively. If the scan limits for azimuth or elevation are set to `[0 0]`, then no scanning is performed along that dimension for that scan mode. If the maximum mechanical scan rate for azimuth or elevation is set to zero, then no mechanical scanning is performed along that dimension.

To generate radar detections:

- 1 Create the `radarEmitter` object and set its properties.
- 2 Call the object with arguments, as if it were a function.

To learn more about how System objects work, see [What Are System Objects?](#).

Creation

Syntax

```
emitter = radarEmitter(EmitterIndex)

emitter = radarEmitter(EmitterIndex,'No scanning')
emitter = radarEmitter(EmitterIndex,'Raster')
emitter = radarEmitter(EmitterIndex,'Rotator')
emitter = radarEmitter(EmitterIndex,'Sector')

emitter = radarEmitter( ___,Name,Value)
```

Description

`emitter = radarEmitter(EmitterIndex)` creates a radar emitter object with default property values.

`emitter = radarEmitter(EmitterIndex,'No scanning')` is a convenience syntax that creates a `radarEmitter` that stares along the radar antenna boresight direction. No mechanical or electronic scanning is performed. This syntax sets the `ScanMode` property to `'No scanning'`.

`emitter = radarEmitter(EmitterIndex,'Raster')` is a convenience syntax that creates a `radarEmitter` object that mechanically scans a raster pattern. The raster span is 90° in azimuth

from -45° to $+45^\circ$ and in elevation from the horizon to 10° above the horizon. See “Convenience Syntaxes” on page 3-322 for the properties set by this syntax.

`emitter = radarEmitter(EmitterIndex, 'Rotator')` is a convenience syntax that creates a `radarEmitter` object that mechanically scans 360° in azimuth by mechanically rotating the antenna at a constant rate. When you set `HasElevation` to `true`, the radar antenna mechanically points towards the center of the elevation field of view. See “Convenience Syntaxes” on page 3-322 for the properties set by this syntax.

`emitter = radarEmitter(EmitterIndex, 'Sector')` is a convenience syntax to create a `radarEmitter` object that mechanically scans a 90° azimuth sector from -45° to $+45^\circ$. Setting `HasElevation` to `true`, points the radar antenna towards the center of the elevation field of view. You can change the `ScanMode` to `'Electronic'` to electronically scan the same azimuth sector. In this case, the antenna is not mechanically tilted in an electronic sector scan. Instead, beams are stacked electronically to process the entire elevation spanned by the scan limits in a single dwell. See “Convenience Syntaxes” on page 3-322 for the properties set by this syntax.

`emitter = radarEmitter(____, Name, Value)` sets properties using one or more name-value pairs after all other input arguments. Enclose each property name in quotes. For example, `radarEmitter('CenterFrequency', 2e6)` creates a radar emitter creates detections in the emitter Cartesian coordinate system and has a maximum detection range of 200 meters. If you specify the emitter index using the `EmitterIndex` property, you can omit the `EmitterIndex` input.

Properties

Unless otherwise indicated, properties are *nontunable*, which means you cannot change their values after calling the object. Objects lock when you call them, and the `release` function unlocks them.

If a property is *tunable*, you can change its value at any time.

For more information on changing property values, see System Design in MATLAB Using System Objects.

EmitterIndex — Unique sensor identifier

positive integer

Unique emitter identifier, specified as a positive integer. When creating a `radarEmitter` system object, you must either specify the `EmitterIndex` as the first input argument in the creation syntax, or specify it as the value for the `EmitterIndex` property in the creation syntax.

Example: 2

Data Types: `double`

UpdateRate — Emitter update rate

1 (default) | positive scalar

Emitter update rate, specified as a positive scalar. The emitter generates new emissions at intervals defined by the reciprocal of the `UpdateRate` property. This interval must be an integer multiple of the simulation time interval defined in `trackingScenario`. Any update requested from the emitter between update intervals contains no emissions. Units are in hertz.

Example: 5

Data Types: `double`

MountingLocation — Emitter location on platform`[0 0 0]` (default) | 1-by-3 real-valued vector

Emitter location on platform, specified as a 1-by-3 real-valued vector. This property defines the coordinates of the emitter with respect to the platform origin. The default value specifies that the emitter origin is at the origin of its platform. Units are in meters.

Example: `[.2 0.1 0]`

Data Types: `double`

MountingAngles — Orientation of emitter`[0 0 0]` (default) | 3-element real-valued vector

Orientation of the emitter with respect to the platform, specified as a three-element real-valued vector. Each element of the vector corresponds to an intrinsic Euler angle rotation that carries the body axes of the platform to the emitter axes. The three elements define the rotations around the *z*, *y*, and *x* axes respectively, in that order. The first rotation rotates the platform axes around the *z*-axis. The second rotation rotates the carried frame around the rotated *y*-axis. The final rotation rotates carried frame around the carried *x*-axis. Units are in degrees.

Example: `[10 20 -15]`

Data Types: `double`

FieldOfView — Fields of view of sensor`[10;50]` | 2-by-1 vector of positive scalar

Fields of view of sensor, specified as a 2-by-1 vector of positive scalars in degree, `[azfov;elfov]`. The field of view defines the total angular extent spanned by the sensor. The azimuth filed of view `azfov` must lie in the interval (0,360]. The elevation filed of view `elfov` must lie in the interval (0,180].

Example: `[14;7]`

Data Types: `double`

ScanMode — Scanning mode of radar`'Mechanical'` (default) | `'Electronic'` | `'Mechanical and electronic'` | `'No scanning'`

Scanning mode of radar, specified as `'Mechanical'`, `'Electronic'`, `'Mechanical and electronic'`, or `'No scanning'`.

Scan Modes

ScanMode	Purpose
'Mechanical'	The radar scans mechanically across the azimuth and elevation limits specified by the <code>MechanicalScanLimits</code> property. The scan direction increments by the radar field of view angle between dwells.
'Electronic'	The radar scans electronically across the azimuth and elevation limits specified by the <code>ElectronicScanLimits</code> property. The scan direction increments by the radar field of view angle between dwells.
'Mechanical and electronic'	The radar mechanically scans the antenna boresight across the mechanical scan limits and electronically scans beams relative to the antenna boresight across the electronic scan limits. The total field of regard scanned in this mode is the combination of the mechanical and electronic scan limits. The scan direction increments by the radar field of view angle between dwells.
'No scanning'	The radar beam points along the antenna boresight defined by the <code>mountingAngles</code> property.

Example: 'No scanning'

Data Types: char

MaxMechanicalScanRate — Maximum mechanical scan rate

[75;75] (default) | nonnegative scalar | real-valued 2-by-1 vector with nonnegative entries

Maximum mechanical scan rate, specified as a nonnegative scalar or real-valued 2-by-1 vector with nonnegative entries.

When `HasElevation` is `true`, specify the scan rate as a 2-by-1 column vector of nonnegative entries, `[maxAzRate; maxElRate]`. `maxAzRate` is the maximum scan rate in azimuth and `maxElRate` is the maximum scan rate in elevation.

When `HasElevation` is `false`, specify the scan rate as a nonnegative scalar representing the maximum mechanical azimuth scan rate.

Scan rates set the maximum rate at which the radar can mechanically scan. The radar sets its scan rate to step the radar mechanical angle by the field of regard. If the required scan rate exceeds the maximum scan rate, the maximum scan rate is used. Units are degrees per second.

Example: [5,10]

Dependencies

To enable this property, set the `ScanMode` property to 'Mechanical' or 'Mechanical and electronic'.

Data Types: double

MechanicalScanLimits — Angular limits of mechanical scan directions of radar

[0 360; -10 0] (default) | real-valued 1-by-2 row vector | real-valued 2-by-2 matrix

Angular limits of mechanical scan directions of radar, specified as a real-valued 1-by-2 row vector or a real-valued 2-by-2 matrix. The mechanical scan limits define the minimum and maximum mechanical angles the radar can scan from its mounted orientation.

When `HasElevation` is true, the scan limits take the form [minAz maxAz; minEl maxEl]. `minAz` and `maxAz` represent the minimum and maximum limits of the azimuth angle scan. `minEl` and `maxEl` represent the minimum and maximum limits of the elevation angle scan. When `HasElevation` is false, the scan limits take the form [minAz maxAz]. If you specify the scan limits as a 2-by-2 matrix but set `HasElevation` to false, the second row of the matrix is ignored.

Azimuthal scan limits cannot span more than 360° and elevation scan limits must lie within the closed interval [-90° 90°]. Units are in degrees.

Example: [-90 90;0 85]

Dependencies

To enable this property, set the `ScanMode` property to 'Mechanical' or 'Mechanical and electronic'.

Data Types: double

MechanicalAngle — Current mechanical scan angle

scalar | real-valued 2-by-1 vector

This property is read-only.

Current mechanical scan angle of radar, returned as a scalar or real-valued 2-by-1 vector. When `HasElevation` is true, the scan angle takes the form [Az;El]. `Az` and `El` represent the azimuth and elevation scan angles, respectively, relative to the mounted angle of the radar on the platform. When `HasElevation` is false, the scan angle is a scalar representing the azimuth scan angle.

Dependencies

To enable this property, set the `ScanMode` property to 'Mechanical' or 'Mechanical and electronic'.

Data Types: double

ElectronicScanLimits — Angular limits of electronic scan directions of radar

[-45 45; -45 45] (default) | real-valued 1-by-2 row vector | real-valued 2-by-2 matrix

Angular limits of electronic scan directions of radar, specified as a real-valued 1-by-2 row vector or a real-valued 2-by-2 matrix. The electronic scan limits define the minimum and maximum electronic angles the radar can scan from its current mechanical direction.

When `HasElevation` is true, the scan limits take the form [minAz maxAz; minEl maxEl]. `minAz` and `maxAz` represent the minimum and maximum limits of the azimuth angle scan. `minEl` and `maxEl` represent the minimum and maximum limits of the elevation angle scan. When `HasElevation` is false, the scan limits take the form [minAz maxAz]. If you specify the scan limits as a 2-by-2 matrix but set `HasElevation` to false, the second row of the matrix is ignored.

Azimuthal scan limits and elevation scan limits must lie within the closed interval $[-90^\circ \ 90^\circ]$. Units are in degrees.

Example: `[-90 90; 0 85]`

Dependencies

To enable this property, set the `ScanMode` property to `'Electronic'` or `'Mechanical and electronic'`.

Data Types: `double`

ElectronicAngle — Current electronic scan angle

`electronic scalar` | `nonnegative scalar`

This property is read-only.

Current electronic scan angle of radar, returned as a scalar or 1-by-2 column vector. When `HasElevation` is `true`, the scan angle takes the form `[Az; El]`. `Az` and `El` represent the azimuth and elevation scan angles, respectively. When `HasElevation` is `false`, the scan angle is a scalar representing the azimuth scan angle.

Dependencies

To enable this property, set the `ScanMode` property to `'Electronic'` or `'Mechanical and electronic'`.

Data Types: `double`

LookAngle — Look angle of emitter

`scalar` | `real-valued 2-by-1 vector`

This property is read-only.

Look angle of emitter, specified as a scalar or real-valued 2-by-1 vector. Look angle is a combination of the mechanical angle and electronic angle depending on the `ScanMode` property. When `HasElevation` is `true`, the look angle takes the form `[Az; El]`. `Az` and `El` represent the azimuth and elevation look angles, respectively. When `HasElevation` is `false`, the look angle is a scalar representing the azimuth look angle.

ScanMode	LookAngle
<code>'Mechanical'</code>	<code>MechanicalAngle</code>
<code>'Electronic'</code>	<code>ElectronicAngle</code>
<code>'Mechanical and Electronic'</code>	<code>MechanicalAngle + ElectronicAngle</code>
<code>'No scanning'</code>	<code>0</code>

Data Types: `double`

HasElevation — Enable radar elevation scan and measurements

`false` (default) | `true`

Enable the radar to measure target elevation angles and to scan in elevation, specified as `false` or `true`. Set this property to `true` to model a radar emitter that can estimate target elevation and scan in elevation.

Data Types: `logical`

EIRP — Effective isotropic radiated power

100 (default) | scalar

Effective isotropic radiated power of the transmitter, specified as a scalar. EIRP is the root mean squared power input to a lossless isotropic antenna that gives the same power density in the far field as the actual transmitter. EIRP is equal to the power input to the transmitter antenna (in dBW) plus the transmitter isotropic antenna gain. Units are in dBi.

Data Types: double

CenterFrequency — Center frequency of radar band

positive scalar

Center frequency of radar band, specified as a positive scalar. Units are in hertz.

Example: 100e6

Data Types: double

Bandwidth — Radar waveform bandwidth

positive scalar

Radar waveform bandwidth, specified as a positive scalar. Units are in hertz.

Example: 100e3

Data Types: double

WaveformTypes — Types of detected waveforms0 (default) | nonnegative integer-valued L -element vector

Types of detected waveforms, specified as a nonnegative integer-valued L -element vector.

Example: [1 4 5]

Data Types: double

ProcessingGain — Processing gain

0 (default) | scalar

Processing gain when demodulating an emitted signal waveform, specified as a scalar. Processing gain is achieved by emitting a signal over a bandwidth which is greater than the minimum bandwidth necessary to send the information contained in the signal. Units are in dB.

Example: 20

Data Types: double

Usage**Syntax**

```
radarsigs = emitter(platform,simTime)
[radarsigs,config] = emitter(platform,simTime)
```

Description

`radarsigs = emitter(platform, simTime)` creates radar signals, `radarsigs`, from emitter on the platform at the current simulation time, `simTime`. The emitter object can simultaneously generate signals from multiple emitters on the platform.

`[radarsigs, config] = emitter(platform, simTime)` also returns the emitter configurations, `config`, at the current simulation time.

Input Arguments

platform – emitter platform

object | structure

Emitter platform, specified as a platform object, `Platform`, or a platform structure:

Field	Description
PlatformID	Unique identifier for the platform, specified as a scalar positive integer. This is a required field which has no default value.
ClassID	User-defined integer used to classify the type of target, specified as a nonnegative integer. Zero is reserved for unclassified platform types and is the default value.
Position	Position of target in scenario coordinates, specified as a real-valued 1-by-3 vector. This is a required field. There is no default value. Units are in meters.
Velocity	Velocity of platform in scenario coordinates, specified as a real-valued 1-by-3 vector. Units are in meters per second. The default is <code>[0 0 0]</code> .
Speed	Speed of the platform in the scenario frame specified as a real scalar. When speed is specified, the platform velocity is aligned with its orientation. Specify either the platform speed or velocity, but not both. Units are in meters per second. The default is <code>0</code> .
Acceleration	Acceleration of the platform in scenario coordinates specified as a 1-by-3 row vector in meters per second-squared. The default is <code>[0 0 0]</code> .
Orientation	Orientation of the platform with respect to the local scenario NED coordinate frame, specified as a scalar quaternion or a 3-by-3 rotation matrix. Orientation defines the frame rotation from the local NED coordinate system to the current platform body coordinate system. Units are dimensionless. The default is <code>quaternion(1, 0, 0, 0)</code> .

Field	Description
AngularVelocity	Angular velocity of platform in scenario coordinates, specified as a real-valued 1-by-3 vector. The magnitude of the vector defines the angular speed. The direction defines the axis of clockwise rotation. Units are in degrees per second. The default is [0 0 0].
Signatures	Cell array of signatures defining the visibility of the platform to emitters and sensors in the scenario. The default is the cell array {rcsSignature, irSignature, tsSignature}.

simTime – Current simulation time

nonnegative scalar

Current simulation time, specified as a positive scalar. The trackingScenario object calls the radar sensor at regular time intervals. The radar emitter generates new signals at intervals defined by the UpdateInterval property. The value of the UpdateInterval property must be an integer multiple of the simulation time interval. Updates requested from the emitter between update intervals contain no detections. Units are in seconds.

Example: 10.5

Data Types: double

Output Arguments

radarsigs – Radar emissions

array of radar emission objects

Radar emissions, returned as an array of radarEmission objects.

config – Current emitter configuration

structure array

Current emitter configurations, returned as an array of structures.

Field	Description
SensorIndex	Unique sensor index, returned as a positive integer.
IsValidTime	Valid detection time, returned as true or false. IsValidTime is false when detection updates are requested between update intervals specified by the update rate.
IsScanDone	IsScanDone is true when the sensor has completed a scan.
FieldOfView	Field of view of the sensor, returned as a 2-by-1 vector of positive real values, [azfov;elfov]. azfov and elfov represent the field of view in azimuth and elevation, respectively.

MeasurementParameters	Sensor measurement parameters, returned as an array of structures containing the coordinate frame transforms needed to transform positions and velocities in the top-level frame to the current sensor frame.
-----------------------	---

Data Types: struct

Object Functions

To use an object function, specify the System object as the first input argument. For example, to release system resources of a System object named `obj`, use this syntax:

```
release(obj)
```

Specific to radarEmitter

`coverageConfig` Sensor and emitter coverage configuration
`perturbations` Perturbation defined on object
`perturb` Apply perturbations to object

Common to All System Objects

`step` Run System object algorithm
`release` Release resources and allow changes to System object property values and input characteristics
`reset` Reset internal states of System object

Examples

Model Radar Jammer

Create an emitter that stares from the front of a jammer.

Create a platform to mount the jammer on.

```
plat = struct( ...
    'PlatformID', 1, ...
    'Position', [0 0 0]);
```

Create an emitter that stares from the front of the jamming platform.

```
jammer = radarEmitter(1, 'No scanning');
```

Emit the jamming waveform.

```
time = 0;
sig = jammer(plat, time)
```

```
sig =
    radarEmission with properties:
```

```
    PlatformID: 1
    EmitterIndex: 1
```

```
OriginPosition: [0 0 0]
OriginVelocity: [0 0 0]
Orientation: [1x1 quaternion]
FieldOfView: [1 5]
CenterFrequency: 300000000
Bandwidth: 3000000
WaveformType: 0
ProcessingGain: 0
PropagationRange: 0
PropagationRangeRate: 0
EIRP: 100
RCS: 0
```

Model Radar Emitter for Air Traffic Control Tower

Model an radar emitter for an air traffic control tower.

Simulate one full rotation of the tower.

```
rpm = 12.5;
scanrate = rpm*360/60;
fov = [1.4;5];
updaterate = scanrate/fov(1);
```

Create a `trackingScenario` object to manage the motion of the platforms.

```
scene = trackingScenario('UpdateRate', updaterate, ...
    'StopTime', 60/rpm);
```

Add a platform to the scenario to host the air traffic control tower.

```
tower = platform(scene);
```

Create an emitter that provides 360 degree surveillance.

```
radarTx = radarEmitter(1,'Rotator', ...
    'UpdateRate',updaterate, ...
    'MountingLocation',[0 0 -15], ...
    'MaxMechanicalScanRate',scanrate, ...
    'FieldOfView',fov);
```

Attach the emitter to the tower.

```
tower.Emitters = radarTx
```

```
tower =
  Platform with properties:

    PlatformID: 1
      ClassID: 0
      Position: [0 0 0]
  Orientation: [0 0 0]
  Dimensions: [1x1 struct]
      Mesh: [1x1 extendedObjectMesh]
  Trajectory: [1x1 kinematicTrajectory]
```

```

PoseEstimator: [1x1 insSensor]
  Emitters: {[1x1 radarEmitter]}
  Sensors: {}
  Signatures: {[1x1 rcsSignature] [1x1 irSignature] [1x1 tsSignature]}

```

Rotate the antenna and emit the radar waveform.

```

loggedData = struct('Time', zeros(0,1), ...
  'Orientation', quaternion.zeros(0, 1));
while advance(scene)
  time = scene.SimulationTime;
  txSig = emit(tower, time);
  loggedData.Time = [loggedData.Time; time];
  loggedData.Orientation = [loggedData.Orientation; ...
    txSig{1}.Orientation];
end

```

Plot the emitter azimuth direction.

```

angles = eulerd(loggedData.Orientation, 'zyx', 'frame');
plot(loggedData.Time, angles(:,1))
title('Emitted Azimuth')
xlabel('Time (s)')
ylabel('Azimuth (deg)')

```

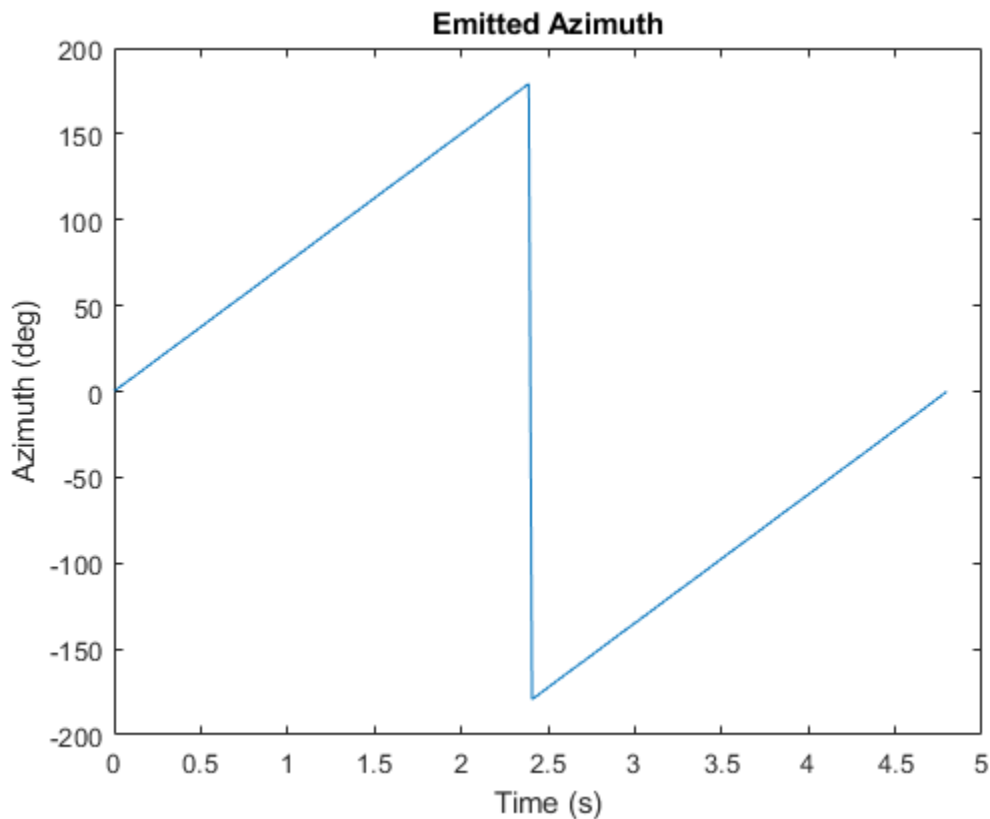

More About

Convenience Syntaxes

The convenience syntaxes set several properties together to model a specific type of radar emitter.

No Scanning

Sets ScanMode to 'No scanning'.

Raster Scanning

This syntax sets these properties:

Property	Value
ScanMode	'Mechanical'
HasElevation	true
MaxMechanicalScanRate	[75;75]
MechanicalScanLimits	[-45 45; -10 0]
ElectronicScanLimits	[-45 45; -10 0]

You can change the ScanMode property to 'Electronic' to perform an electronic raster scan over the same volume as a mechanical scan.

Rotator Scanning

This syntax sets these properties:

Property	Value
ScanMode	'Mechanical'
FieldOfView	[1;10]
HasElevation	false or true
MechanicalScanLimits	[0 360; -10 0]
ElevationResolution	10/sqrt(12)

Sector Scanning

This syntax sets these properties:

Property	Value
ScanMode	'Mechanical'
FieldOfView	[1;10]
HasElevation	false
MechanicalScanLimits	[-45 45; -10 0]
ElectronicScanLimits	[-45 45; -10 0]
ElevationResolution	10/sqrt(12)

Changing the ScanMode property to 'Electronic' lets you perform an electronic raster scan over the same volume as a mechanical scan.

Extended Capabilities

C/C++ Code Generation

Generate C and C++ code using MATLAB® Coder™.

Usage notes and limitations:

See “System Objects in MATLAB Code Generation” (MATLAB Coder).

See Also

`emissionsInBody` | `platform` | `radarEmission` | `targetPoses`

Introduced in R2018b

rccSignature

Radar cross-section pattern

Description

`rccSignature` creates a radar cross-section (RCS) signature object. You can use this object to model an angle-dependent and frequency-dependent radar cross-section pattern. The radar cross-section determines the intensity of reflected radar signal power from a target. The object models only non-polarized signals.

Creation

Syntax

```
rccsig = rccSignature  
rccsig = rccSignature(Name,Value)
```

Description

`rccsig = rccSignature` creates an `rccSignature` object with default property values.

`rccsig = rccSignature(Name,Value)` sets object properties using one or more `Name, Value` pair arguments. `Name` is a property name and `Value` is the corresponding value. `Name` must appear inside single quotes (' '). You can specify several name-value pair arguments in any order as `Name1, Value1, . . . , NameN, ValueN`. Any unspecified properties take default values.

Note You can only set property values of `rccSignature` when constructing the object. The property values are not changeable after construction.

Properties

Pattern — Sampled radar cross-section pattern

[10 10; 10 10] (default) | Q -by- P real-valued matrix | Q -by- P -by- K real-valued array

Sampled radar cross-section (RCS) pattern, specified as a scalar, a Q -by- P real-valued matrix, or a Q -by- P -by- K real-valued array. The pattern is an array of RCS values defined on a grid of elevation angles, azimuth angles, and frequencies. Azimuth and elevation are defined in the body frame of the target.

- Q is the number of RCS samples in elevation.
- P is the number of RCS samples in azimuth.
- K is the number of RCS samples in frequency.

Q , P , and K usually match the length of the vectors defined in the `Elevation`, `Azimuth`, and `Frequency` properties, respectively, with these exceptions:

- To model an RCS pattern for an elevation cut (constant azimuth), you can specify the RCS pattern as a Q -by-1 vector or a 1-by- Q -by- K matrix. Then, the elevation vector specified in the `Elevation` property must have length 2.
- To model an RCS pattern for an azimuth cut (constant elevation), you can specify the RCS pattern as a 1-by- P vector or a 1-by- P -by- K matrix. Then, the azimuth vector specified in the `Azimuth` property must have length 2.
- To model an RCS pattern for one frequency, you can specify the RCS pattern as a Q -by- P matrix. Then, the frequency vector specified in the `Frequency` property must have length 2.

Example: `[10,0;0,-5]`

Data Types: `double`

Azimuth — Azimuth angles

`[-180 180]` (default) | length- P real-valued vector

Azimuth angles used to define the angular coordinates of each column of the matrix or array, specified by the `Pattern` property. Specify the azimuth angles as a length- P vector. P must be greater than two. Angle units are in degrees.

Example: `[-45:0.5:45]`

Data Types: `double`

Elevation — Elevation angles

`[-90 90]` (default) | length- Q real-valued vector

Elevation angles used to define the coordinates of each row of the matrix or array, specified by the `Pattern` property. Specify the elevation angles as a length- Q vector. Q must be greater than two. Angle units are in degrees.

Example: `[-30:0.5:30]`

Data Types: `double`

Frequency — Pattern frequencies

`[0 1e20]` (default) | K -element vector of positive scalars

Frequencies used to define the applicable RCS for each page of the `Pattern` property, specified as a K -element vector of positive scalars. K is the number of RCS samples in frequency. K must be no less than two. Frequency units are in hertz.

Example: `[0:0.1:30]`

Data Types: `double`

Object Functions

`value` Radar cross-section at specified angle and frequency

`toStruct` Convert to structure

Examples

Radar Cross-Section of Ellipsoid

Specify the radar cross-section (RCS) of a triaxial ellipsoid and plot RCS values along an azimuth cut.

Specify the lengths of the axes of the ellipsoid. Units are in meters.

```
a = 0.15;
b = 0.20;
c = 0.95;
```

Create an RCS array. Specify the range of azimuth and elevation angles over which RCS is defined. Then, use an analytical model to compute the radar cross-section of the ellipsoid. Create an image of the RCS.

```
az = [-180:1:180];
el = [-90:1:90];
rsc = rcs_ellipsoid(a,b,c,az,el);
rcsdb = 10*log10(rsc);
imagesc(az,el,rcsdb)
title('Radar Cross-Section')
xlabel('Azimuth (deg)')
ylabel('Elevation (deg)')
colorbar
```

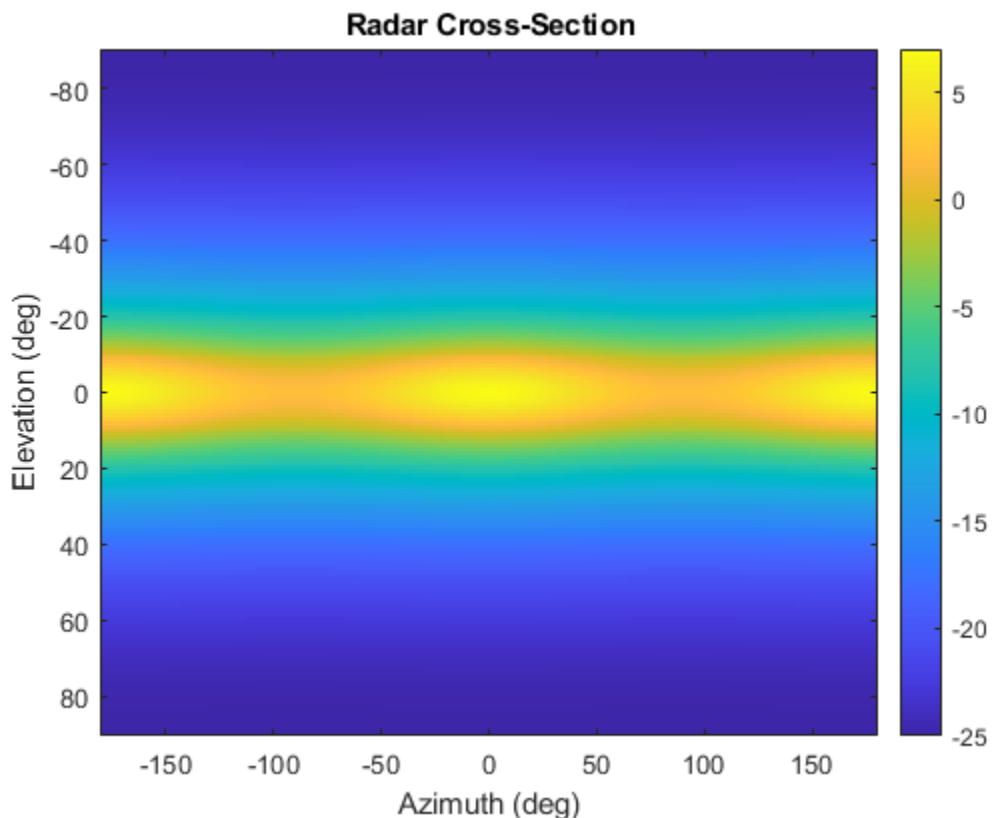

Create an `rcsSignature` object and plot an elevation cut at 30° azimuth.

```
rcssig = rcsSignature('Pattern',rcsdb,'Azimuth',az,'Elevation',el,'Frequency',[300e6 300e6]);
rcsdb1 = value(rcssig,30,el,300e6);
plot(el,rcsdb1)
grid
title('Elevation Profile of Radar Cross-Section')
```



```
xlabel('Elevation (deg)')
ylabel('RCS (dBsm)')
```

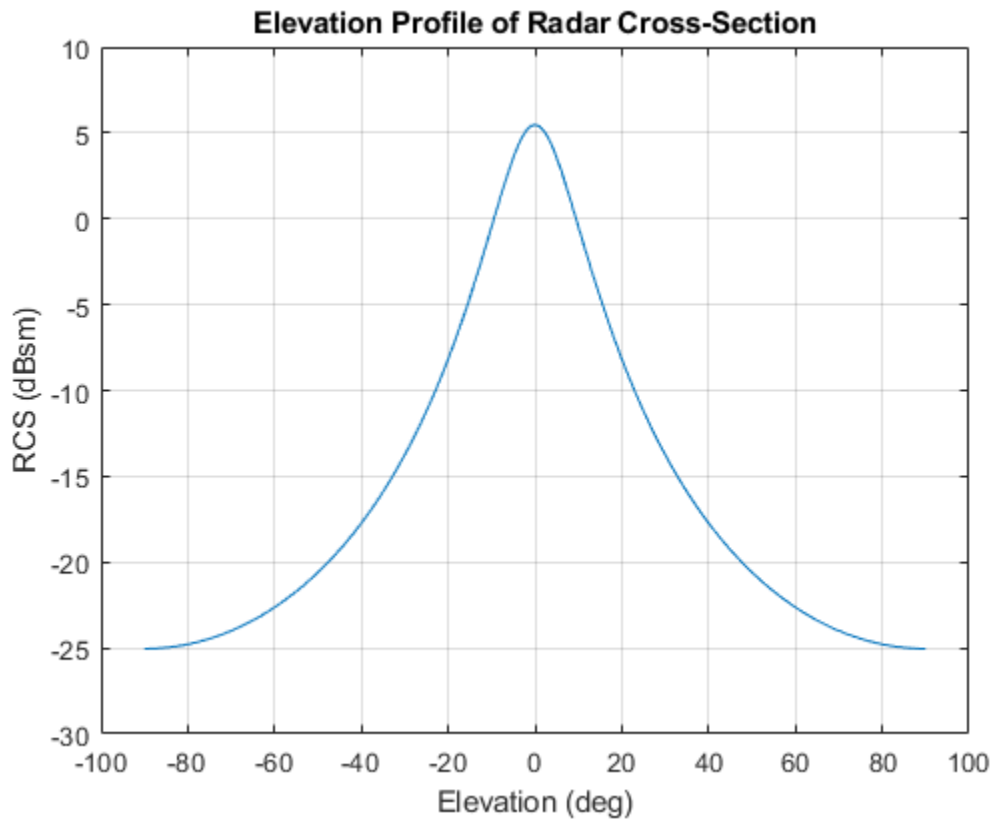

```
function rcs = rcs_ellipsoid(a,b,c,az,el)
sinaz = sind(az);
cosaz = cosd(az);
sintheta = sind(90 - el);
costheta = cosd(90 - el);
denom = (a^2*(sintheta'.^2)*cosaz.^2 + b^2*(sintheta'.^2)*sinaz.^2 + c^2*(costheta'.^2)*ones(size(sintheta',2)));
rcs = (pi*a^2*b^2*c^2)./denom;
end
```

References

[1] Richards, Mark A. *Fundamentals of Radar Signal Processing*. New York, McGraw-Hill, 2005.

Extended Capabilities

C/C++ Code Generation

Generate C and C++ code using MATLAB® Coder™.

See Also

Classes

tsSignature

Introduced in R2018b

value

Radar cross-section at specified angle and frequency

Syntax

```
rcsval = value(rcssig,az,el,freq)
```

Description

`rcsval = value(rcssig,az,el,freq)` returns the value, `rcsval`, of the radar cross-section (RCS) specified by the radar signature object, `rcssig`, computed at the specified azimuth `az`, elevation `el`, and frequency `freq`. If the specified azimuth and elevation is outside of the region in which the RCS signature is defined, the RCS value, `rcsval`, is returned as `-Inf` in dBsm.

Input Arguments

rcssig — RCS signature object

`rcsSignature` object

Radar cross-section signature, specified as an `rcsSignature` object.

az — Azimuth angle

scalar | length-*M* real-valued vector

Azimuth angle, specified as scalar or length-*M* real-valued vector. Units are in degrees. The `az`, `el`, and `freq` arguments must have the same size. You can, however, specify one or two arguments as scalars, in which case the arguments are expanded to length-*M*.

Data Types: `double`

el — Elevation angle

scalar | length-*M* real-valued vector

Elevation angle, specified as scalar or length-*M* real-valued vector. The `az`, `el`, and `freq` arguments must have the same size. You can, however, specify one or two arguments as scalars, in which case the arguments are expanded to length-*M*. Units are in degrees.

Data Types: `double`

freq — RCS frequency

positive scalar | length-*M* vector with positive, real elements

RCS frequency, specified as a positive scalar or length-*M* vector with positive, real elements. The `az`, `el`, and `freq` arguments must have the same size. You can, however, specify one or two arguments as scalars, in which case the arguments are expanded to length-*M* vectors. Units are in Hertz.

Example: `100e6`

Data Types: `double`

Output Arguments

rscval — Radar cross-section

scalar | real-valued length- M vector

Radar cross-section, returned as a scalar or real-valued length- M vector. Units are in dBsm.

Examples

Radar Cross-Section of Ellipsoid

Specify the radar cross-section (RCS) of a triaxial ellipsoid and plot RCS values along an azimuth cut.

Specify the lengths of the axes of the ellipsoid. Units are in meters.

```
a = 0.15;  
b = 0.20;  
c = 0.95;
```

Create an RCS array. Specify the range of azimuth and elevation angles over which RCS is defined. Then, use an analytical model to compute the radar cross-section of the ellipsoid. Create an image of the RCS.

```
az = [-180:1:180];  
el = [-90:1:90];  
rsc = rsc_ellipsoid(a,b,c,az,el);  
rscdb = 10*log10(rsc);  
imagesc(az,el,rscdb)  
title('Radar Cross-Section')  
xlabel('Azimuth (deg)')  
ylabel('Elevation (deg)')  
colorbar
```

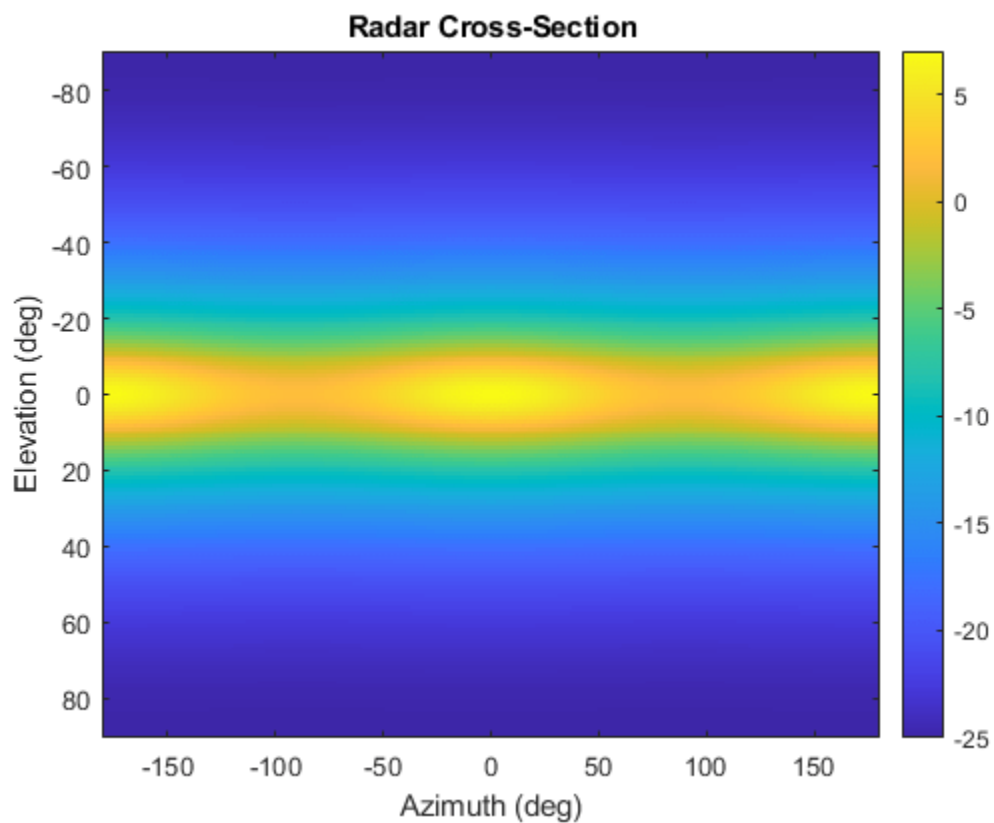

Create an `rccSignature` object and plot an elevation cut at 30° azimuth.

```
rccsig = rccSignature('Pattern',rcsdb,'Azimuth',az,'Elevation',el,'Frequency',[300e6 300e6]);  
rcsdbl = value(rccsig,30,el,300e6);  
plot(el,rcsdbl)  
grid  
title('Elevation Profile of Radar Cross-Section')  
xlabel('Elevation (deg)')  
ylabel('RCS (dBsm)')
```

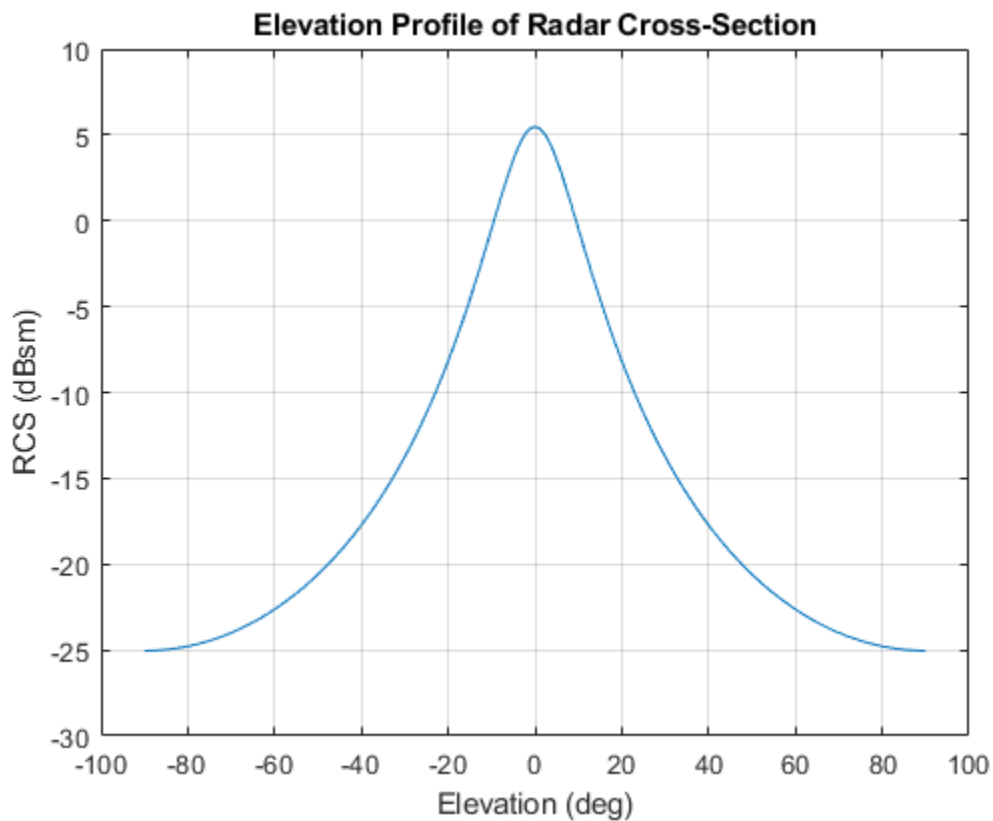

```
function rcs = rcs_ellipsoid(a,b,c,az,el)
sinaz = sind(az);
cosaz = cosd(az);
sintheta = sind(90 - el);
costheta = cosd(90 - el);
denom = (a^2*(sintheta'.^2)*cosaz.^2 + b^2*(sintheta'.^2)*sinaz.^2 + c^2*(costheta'.^2)*ones(size(sintheta',2)));
rcs = (pi*a^2*b^2*c^2)./denom;
end
```

Extended Capabilities

C/C++ Code Generation

Generate C and C++ code using MATLAB® Coder™.

See Also

Introduced in R2018b

toStruct

Convert to structure

Syntax

```
rcsStruct = toStruct(rcsSig)
```

Description

`rcsStruct = toStruct(rcsSig)` converts the `rcsSignature` object `rcsSig` to a structure `rcsStruct`. The field names of the returned structure are the same as the property names of the `rcsSignature` object.

Examples

Convert rcsSignature to Structure

Create a `rcsSignature` object.

```
rcsSig = rcsSignature
```

```
rcsSig =  
    rcsSignature with properties:  
  
    Pattern: [2x2 double]  
    Azimuth: [-180 180]  
    Elevation: [2x1 double]  
    Frequency: [0 1.0000e+20]
```

Convert the signature to a structure.

```
rcsStruct = toStruct(rcsSig)  
  
rcsStruct = struct with fields:  
    Pattern: [2x2 double]  
    Azimuth: [-180 180]  
    Elevation: [2x1 double]  
    Frequency: [0 1.0000e+20]
```

Input Arguments

rcsSig — RCS signature

`rcsSignature` object

RCS signature, specified as an `rcsSignature` object.

Output Arguments

rcsStruct — RCS structure

structure

RCS structure, returned as a structure.

Introduced in R2020b

radarEmission

Emitted radar signal structure

Description

The `radarEmission` class creates a radar emission object. This object contains all the properties that describe a signal radiated by a radar source.

Creation

Syntax

```
signal = radarEmission  
signal = radarEmission(Name, Value)
```

Description

`signal = radarEmission` creates a `sonarEmission` object with default properties. The object represents radar signals from emitters, channels, and sensors.

`signal = radarEmission(Name, Value)` sets object properties specified by one or more `Name, Value` pair arguments. `Name` can also be a property name and `Value` is the corresponding value. `Name` must appear inside single quotes (' '). You can specify several name-value pair arguments in any order as `Name1, Value1, ..., NameN, ValueN`.

Properties

PlatformID — Platform identifier

positive integer

Platform identifier, specified as a positive integer. The emitter is mounted on the platform with this ID. Each platform identifier is unique within a scenario.

Example: 5

Data Types: double

EmitterIndex — Emitter identifier

positive integer

Emitter identifier, specified as a positive integer. Each emitter index is unique.

Example: 2

Data Types: double

OriginPosition — Location of emitter

[0 0 0] (default) | 1-by-3 real-valued vector

Location of the emitter in scenario coordinates, specified as a 1-by-3 real-valued vector. Units are in meters.

Example: [100 -500 1000]

Data Types: double

OriginVelocity — Velocity of emitter

[0 0 0] (default) | 1-by-3 real-valued vector

Velocity of the emitter in scenario coordinates, specified as a 1-by-3 real-valued vector. Units are in meters per second.

Example: [0 -50 100]

Data Types: double

Orientation — Orientation of emitter

quaternion(1,0,0,0) (default) | quaternion | 3-by-3 real-valued orthogonal matrix

Orientation of the emitter in scenario coordinates, specified as a quaternion or 3-by-3 real-valued orthogonal matrix.

Example: eye(3)

Data Types: double

FieldOfView — Field of view of emitter

[180,180] | 2-by-1 vector of positive real values

Field of view of emitter, specified as a 2-by-1 vector of positive real values, [azfov, elfov]. The field of view defines the total angular extent of the signal emitted. The azimuth filed of view azfov must lie in the interval (0,360]. The elevation filed of view elfov must lie in the interval (0,180].

Example: [140;70]

Data Types: double

EIRP — Effective isotropic radiated power

0 (default) | scalar

Effective isotropic radiated power, specified as a scalar. Units are in dB.

Example: 10

Data Types: double

RCS — Cumulative radar cross-section

0 (default) | scalar

Cumulative radar cross-section, specified as a scalar. Units are in dBsm.

Example: 10

Data Types: double

CenterFrequency — Center frequency of radar signal

300e6 (default) | positive scalar

Center frequency of the signal, specified as a positive scalar. Units are in Hz.

Example: 100e6

Data Types: double

Bandwidth — Half-power bandwidth of radar signal

30e6 (default) | positive scalar

Half-power bandwidth of the radar signal, specified as a positive scalar. Units are in Hz.

Example: 5e3

Data Types: double

WaveformType — Waveform type identifier

0 (default) | nonnegative integer

Waveform type identifier, specified as a nonnegative integer.

Example: 5e3

Data Types: double

ProcessingGain — Processing gain

0 (default) | scalar

Processing gain associated with the signal waveform, specified as a scalar. Units are in dB.

Example: 10

Data Types: double

PropagationRange — Distance signal propagates

0 (default) | nonnegative scalar

Total distance over which the signal has propagated, specified as a nonnegative scalar. For direct-path signals, the range is zero. Units are in meters.

Example: 1000

Data Types: double

PropagationRangeRate — Range rate of signal propagation path

0 (default) | scalar

Total range rate for the path over which the signal has propagated, specified as a scalar. For direct-path signals, the range rate is zero. Units are in meters per second.

Example: 10

Data Types: double

Examples

Create Radar Emission Object

Create a radarEmission object with specified properties.

```
signal = radarEmission('PlatformID',10,'EmitterIndex',25, ...  
    'OriginPosition',[100,3000,50],'EIRP',10,'CenterFrequency',200e6, ...  
    'Bandwidth',10e3)
```

```
signal =  
    radarEmission with properties:  
  
        PlatformID: 10  
        EmitterIndex: 25  
        OriginPosition: [100 3000 50]  
        OriginVelocity: [0 0 0]  
        Orientation: [1x1 quaternion]  
        FieldOfView: [180 180]  
        CenterFrequency: 200000000  
        Bandwidth: 10000  
        WaveformType: 0  
        ProcessingGain: 0  
        PropagationRange: 0  
        PropagationRangeRate: 0  
        EIRP: 10  
        RCS: 0
```

Detect Radar Emission with fusionRadarSensor

Create an radar emission and then detect the emission using a fusionRadarSensor object.

First, create an radar emission.

```
orient = quaternion([180 0 0],'eulerd','zyx','frame');  
rfSig = radarEmission('PlatformID',1,'EmitterIndex',1,'EIRP',100, ...  
    'OriginPosition',[30 0 0],'Orientation',orient);
```

Then, create an ESM sensor using fusionRadarSensor.

```
sensor = fusionRadarSensor(1,'DetectionMode','ESM');
```

Detect the RF emission.

```
time = 0;  
[dets,numDets,config] = sensor(rfSig,time)
```

```
dets = 1x1 cell array  
    {1x1 objectDetection}
```

```
numDets = 1
```

```
config = struct with fields:  
    SensorIndex: 1  
    IsValidTime: 1  
    IsScanDone: 0  
    FieldOfView: [1 5]  
    MeasurementParameters: [1x1 struct]
```

Extended Capabilities

C/C++ Code Generation

Generate C and C++ code using MATLAB® Coder™.

See Also

radarChannel | radarEmitter | sonarEmission

Introduced in R2018b

radarChannel

Free space propagation and reflection of radar signals

Syntax

```
radarsigout = radarChannel(radarsigin,platforms)
radarsigout = radarChannel(radarsigin,platforms,'HasOcclusion',HasOcclusion)
```

Description

`radarsigout = radarChannel(radarsigin,platforms)` returns radar signals, `radarsigout`, as combinations of the signals, `radarsigin`, that are reflected from the platforms, `platforms`.

`radarsigout = radarChannel(radarsigin,platforms,'HasOcclusion',HasOcclusion)` also allows you to specify whether to model occlusion from extended objects.

Examples

Reflect Radar Emission From Platform

Create a radar emission and a platform and reflect the emission from the platform.

Create a radar emission object.

```
radarSig = radarEmission('PlatformID',1,'EmitterIndex',1,'OriginPosition',[0 0 0]);
```

Create a platform structure.

```
platfm = struct('PlatformID',2,'Position',[10 0 0],'Signatures',rcsSignature());
```

Reflect the emission from the platform.

```
sigs = radarChannel(radarSig,platfm)
```

```
sigs =
```

```
radarEmission with properties:
```

```
PlatformID: 1
EmitterIndex: 1
OriginPosition: [0 0 0]
OriginVelocity: [0 0 0]
Orientation: [1x1 quaternion]
FieldOfView: [180 180]
CenterFrequency: 300000000
Bandwidth: 3000000
WaveformType: 0
ProcessingGain: 0
PropagationRange: 0
PropagationRangeRate: 0
EIRP: 0
RCS: 0
```

Reflect Radar Emission From Platform within Tracking Scenario

Create a tracking scenario object.

```
scenario = trackingScenario;
```

Create a radarEmitter object.

```
emitter = radarEmitter(1);
```

Mount the emitter on a platform within the scenario.

```
plat = platform(scenario, 'Emitters', emitter);
```

Add another platform to reflect the emitted signal.

```
target = platform(scenario);
target.Trajectory.Position = [30 0 0];
```

Emit the signal using the emit object function of a platform.

```
txsigs = emit(plat, scenario.SimulationTime)
```

```
txsigs = 1x1 cell array
        {1x1 radarEmission}
```

Reflect the signal from the platforms in the scenario.

```
sigs = radarChannel(txsigs, scenario.Platforms)
```

```
sigs=2x1 cell array
        {1x1 radarEmission}
        {1x1 radarEmission}
```

Input Arguments

radarsigin — Input radar signals

array of radarEmission objects

Input radar signals, specified as an array of radarEmission objects.

platforms — Reflector platforms

cell array of Platform objects | array of Platform structures

Reflector platforms, specified as a cell array of Platform objects, or an array of Platform structures:

Field	Description
PlatformID	Unique identifier for the platform, specified as a scalar positive integer. This is a required field which has no default value.
ClassID	User-defined integer used to classify the type of target, specified as a nonnegative integer. Zero is reserved for unclassified platform types and is the default value.
Position	Position of target in scenario coordinates, specified as a real-valued 1-by-3 vector. This is a required field. There is no default value. Units are in meters.
Velocity	Velocity of platform in scenario coordinates, specified as a real-valued 1-by-3 vector. Units are in meters per second. The default is [0 0 0].
Speed	Speed of the platform in the scenario frame specified as a real scalar. When speed is specified, the platform velocity is aligned with its orientation. Specify either the platform speed or velocity, but not both. Units are in meters per second The default is 0.
Acceleration	Acceleration of the platform in scenario coordinates specified as a 1-by-3 row vector in meters per second-squared. The default is [0 0 0].
Orientation	Orientation of the platform with respect to the local scenario NED coordinate frame, specified as a scalar quaternion or a 3-by-3 rotation matrix. Orientation defines the frame rotation from the local NED coordinate system to the current platform body coordinate system. Units are dimensionless. The default is <code>quaternion(1,0,0,0)</code> .
AngularVelocity	Angular velocity of platform in scenario coordinates, specified as a real-valued 1-by-3 vector. The magnitude of the vector defines the angular speed. The direction defines the axis of clockwise rotation. Units are in degrees per second. The default is [0 0 0].
Signatures	Cell array of signatures defining the visibility of the platform to emitters and sensors in the scenario. The default is the cell array {rcsSignature, irSignature, tsSignature}.

If you specify an array of platform structures, set a unique `PlatformID` for each platform and set the `Position` field for each platform. Any other fields not specified are assigned default values.

HasOcclusion — Enable occlusion from extended objects`true | false`

Enable occlusion from extended objects, specified as `true` or `false`. Set `HasOcclusion` to `true` to model occlusion from extended objects. Two types of occlusion (self occlusion and inter object occlusion) are modeled. Self occlusion occurs when one side of an extended object occludes another side. Inter object occlusion occurs when one extended object stands in the line of sight of another extended object or a point target. Note that both extended objects and point targets can be occluded by extended objects, but a point target cannot occlude another point target or an extended object.

Set `HasOcclusion` to `false` to disable occlusion of extended objects. This will also disable the merging of objects whose detections share a common sensor resolution cell, which gives each object in the tracking scenario an opportunity to generate a detection.

Data Types: `logical`

Output Arguments**radarsigout — Reflected radar signals**`array of radarEmission objects`

Reflected radar signals, specified as an array of `radarEmission` objects.

Extended Capabilities**C/C++ Code Generation**

Generate C and C++ code using MATLAB® Coder™.

See Also

`radarEmission` | `radarEmitter` | `radarSensor`

Introduced in R2018b

monostaticLidarSensor

Simulate and model lidar point cloud generator

Description

The `monostaticLidarSensor` System object generates point cloud detections of targets by a monostatic lidar sensor. You can use the `monostaticLidarSensor` object in a scenario containing moving and stationary platforms such as one created using `trackingScenario`. The `monostaticLidarSensor` object generates point clouds from platforms with defined meshes (using the `Mesh` property). The `monostaticLidarSensor` System object models an ideal point cloud generator and does not account for the effects of false alarms and missed detections.

To generate point cloud detections using a simulated lidar sensor:

- 1 Create the `monostaticLidarSensor` object and set its properties.
- 2 Call the object with arguments, as if it were a function.

To learn more about how System objects work, see [What Are System Objects?](#).

Creation

Syntax

```
sensor = monostaticLidarSensor(SensorIndex)
sensor = monostaticLidarSensor(SensorIndex,Name,Value)
```

Description

`sensor = monostaticLidarSensor(SensorIndex)` creates a simulated lidar sensor with a specified sensor index, `SensorIndex`. Default property values are used.

`sensor = monostaticLidarSensor(SensorIndex,Name,Value)` sets properties using one or more name-value pairs. Enclose each property name in quotes. For example, `monostaticLidarSensor(1,'DetectionCoordinates','Sensor')` creates a simulated lidar sensor that reports detections in the sensor Cartesian coordinate system with sensor index equal to 1.

Properties

Unless otherwise indicated, properties are *nontunable*, which means you cannot change their values after calling the object. Objects lock when you call them, and the `release` function unlocks them.

If a property is *tunable*, you can change its value at any time.

For more information on changing property values, see [System Design in MATLAB Using System Objects](#).

SensorIndex — Unique sensor identifier

positive integer

Unique sensor identifier, specified as a positive integer. This property distinguishes point clouds generated from different sensors in a multi-sensor system. When creating a `monostaticLidarSensor` system object, you must either specify the `SensorIndex` as the first input argument in the creation syntax, or specify it as the value for the `SensorIndex` property in the creation syntax.

UpdateRate — Sensor update rate

15 (default) | positive scalar

Sensor update rate, specified as a positive scalar in Hz. The update interval (reciprocal of the `UpdateRate`) must be an integer multiple of the simulation time interval defined in `trackingScenario`. Any update requested to the sensor between update intervals contains no point clouds.

Example: 5

Data Types: `double`

MountingLocation — Sensor location on platform

[1.5 0 0] (default) | 1-by-3 real-valued vector

Sensor location on platform, specified as a 1-by-3 real-valued vector. This property defines the coordinates of the sensor with respect to the platform origin. The default value specifies that the sensor origin is 1.5 meters forward of the platform origin. Units are in meters.

Example: [.2 0.1 0]

Data Types: `double`

MountingAngles — Sensor mounting orientation

[0 0 0] (default) | 3-element vector of scalar

Sensor mounting orientation on the platform, specified as a 3-element vector of scalars in degrees. Each element of the vector corresponds to an intrinsic Euler angle rotation that carries the body axes of the platform to the sensor axes. The three elements define the rotations around the z -, y -, and x -axes, in that order. The first rotation rotates the platform axes around the z -axis. The second rotation rotates the frame around the rotated y -axis. The final rotation rotates the frame around the carried x -axis.

Example: [10 20 -15]

Data Types: `double`

MaxRange — Maximum detection range

120 (default) | positive scalar

Maximum detection range, specified as a positive scalar in meters.

Example: 500

Data Types: `double`

RangeAccuracy — Accuracy of range measurements

0.002 (default) | positive scalar

Accuracy of range measurements, specified as a positive scalar in meters. The property value represents is the standard deviation of the range measurements.

Example: 0.1

Data Types: `double`

AzimuthResolution — Azimuth resolution

`0.16` (default) | positive scalar

Azimuth resolution of the lidar sensor, specified as a positive scalar in degrees. The number of points per elevation channel is equal to the azimuth limits divided by the azimuth resolution.

Data Types: `double`

ElevationResolution — Elevation resolution

`1.25` (default) | positive scalar

Elevation resolution of the lidar sensor, specified as a positive scalar in degrees. The number of points per azimuth channel is equal to the elevation limits divided by the elevation resolution.

Data Types: `double`

AzimuthLimits — Azimuth limits

`[-180 180]` (default) | 1-by-2 row vector of scalar

Azimuth limits of the lidar sensor, specified as a 1-by-2 row vector of scalars in degrees.

Example: `[-90 90]`

Data Types: `double`

ElevationLimits — Elevation limits

`[-20 20]` (default) | 1-by-2 row vector of scalar

Elevation limits of the lidar sensor, specified as a 1-by-2 row vector of scalars in degrees.

Example: `[-90 90]`

Data Types: `double`

HasNoise — Enable addition of noise to point cloud locations

`true` (default) | `false`

Enable addition of noise to point cloud locations, specified as `true` or `false`. Set this property to `true` to add noise to point cloud locations. Otherwise, the point cloud locations contain no noise. The sensor adds random Gaussian noise to each point with mean equal to zero and standard deviation specified by the `RangeAccuracy` property.

Data Types: `logical`

HasOrganizedOutput — Enable organized point cloud locations

`false` (default) | `true`

Enable organized point cloud locations, specified as `true` or `false`.

- When this property is set as `true`, the point cloud output is an N -by- M -by-3 array of scalars, where N is the number of elevation channels, and M is the number of azimuth channels.
- When this property is set as `false`, the point cloud output is an P -by-3 matrix of scalars, where P is the product of the numbers of elevation and azimuth channels.

Data Types: `logical`

HasINS — Enable inertial navigation system (INS) input`false (default) | true`

Enable the optional input argument that passes the current INS estimate of the sensor platform pose to the sensor, specified as `false` or `true`. When `true`, the pose information is added to the `MeasurementParameters` property of the configuration, enabling tracking and fusion algorithms to estimate the state of the targets in the scenario frame. It also enables to report the point cloud locations in the scenario frame.

Data Types: `logical`

DetectionCoordinates — Coordinate system of reported detections`'Sensor' (default) | 'Body' | 'Scenario'`

Coordinate system in which the detections are reported, specified as:

- `'Sensor'` — Detections are reported in the sensor's rectangular coordinate system.
- `'Body'` — Detections are reported in the rectangular body system of the platform.
- `'Scenario'` — Detections are reported in the rectangular scenario coordinate frame. To enable this value, set the `HasINS` property to `true`.

Data Types: `char`

Usage**Syntax**

```
pointCloud = sensor(targetMeshes,time)
pointCloud = sensor(targetMeshes,insPose,time)
[pointCloud,config] = sensor( ___ )
[pointCloud,config,clusters] = sensor( ___ )
```

Description

`pointCloud = sensor(targetMeshes,time)` returns point cloud measurements from the 3-D geometric meshes of targets, `tgtMeshes`, at the simulation `time`.

`pointCloud = sensor(targetMeshes,insPose,time)` also specifies the INS-estimated pose, `insPose`, for the sensor platform. INS information is used by tracking and fusion algorithms to estimate the target positions in the scenario frame.

To enable this syntax, set the `HasINS` property to `true`.

`[pointCloud,config] = sensor(___)` also returns the configuration of the sensor, `config`, at the current simulation time. You can use these output arguments with any of the previous input syntaxes.

`[pointCloud,config,clusters] = sensor(___)` also returns `clusters`, the true cluster labels for each point in the point cloud.

Input Arguments**targetMeshes — Meshes of targets**

array of structure

Meshes of targets, specified as an array of structures. Each structure must contain the following fields.

Field Name	Description
PlatformID	Unique identifier of the target, specified as a nonnegative integer.
ClassID	Unique identifier of the class of the target, specified as a nonnegative integer.
Position	Position of the target with respect to the sensor mounting platform's body frame, specified as a 3-element vector of scalars.
Orientation	Orientation of the target with respect to the sensor mounting platform's body frame, specified as a quaternion object or a rotation matrix.
Mesh	Geometric mesh of the target, specified as an <code>extendedObjectMesh</code> object with respect to the target's body frame.

insPose — Platform pose from INS
structure

Platform pose from INS estimation, specified as a structure. The INS information can be used by tracking and fusion algorithms to estimate the platform's pose and velocity in the scenario frame.

Platform pose information from an inertial navigation system (INS) is a structure with these fields:

Field	Definition
Position	Position in the navigation frame, specified as a real-valued 1-by-3 vector. Units are in meters.
Velocity	Velocity in the navigation frame, specified as a real-valued 1-by-3 vector. Units are in meters per second.
Orientation	Orientation with respect to the navigation frame, specified as a quaternion or a 3-by-3 real-valued rotation matrix. The rotation is from the navigation frame to the current INS body frame. This is also referred to as a "parent to child" rotation.

Dependencies

To enable this argument, set the `HasINS` property to `true`.

Data Types: `struct`

time — Current simulation time
nonnegative scalar

Current simulation time, specified as a positive scalar in seconds.

Data Types: `double`

Output Arguments

pointCloud — Point cloud detections

N-by-*M*-by-3 array of scalars | *P*-by-3 matrix of scalars

Point cloud detections generated by the sensor, return as an array of scalars. The dimension of the array is determined by the `HasOrganizedOutput` property.

- When the property is set as `true`, `pointClouds` is returned an *N*-by-*M*-by-3 array of scalars, where *N* is the number of elevation channels, and *M* is the number of azimuth channels.
- When the property is set as `false`, `pointClouds` is returned as an *P*-by-3 matrix of scalars, where *P* is the product of the numbers of elevation and azimuth channels.

The coordinate frame in which the point cloud locations are reported is determined by the `DetectionCoordinates` property.

config — Current sensor configuration

structure

Current sensor configuration, returned as a structure. The structure has these fields:

Field	Description
<code>SensorIndex</code>	Unique sensor index, returned as a positive integer.
<code>IsValidTime</code>	Valid detection time, returned as <code>true</code> or <code>false</code> . <code>IsValidTime</code> is <code>false</code> when detection updates are requested between update intervals specified by the update rate.
<code>IsScanDone</code>	<code>IsScanDone</code> is <code>true</code> when the sensor has completed a scan.
<code>FieldOfView</code>	Field of view of the sensor, returned as a 2-by-2 matrix of positive real values. The first row elements are the lower and upper azimuth limits; the second row elements are the lower and upper elevation limits.
<code>MeasurementParameters</code>	Sensor measurement parameters, returned as an array of structures containing the coordinate frame transforms needed to transform positions and velocities in the top-level frame to the current sensor frame.

Data Types: `struct`

clusters — Cluster labels of points

N-by-*M*-by-2 array of nonnegative integer | *P*-by-2 matrix of nonnegative integer

Cluster labels of points in the `pointCloud` output, returned as an array of nonnegative integers. The dimension of the array is determined by the `HasOrganizedOutput` property.

- When this property is set as `true`, `cluster` is returned as an *N*-by-*M*-by-2 array of scalars, where *N* is the number of elevation channels, and *M* is the number of azimuth channels. On the third

dimension, the first element represents the PlatformID of the target generating the point, and the second element represents the ClassID of the target.

- When this property is set as `false`, `pointClouds` is returned as a P -by-2 matrix of scalars, where P is the product of the numbers of elevation and azimuth channels. For each column of the matrix, the first element represents the PlatformID of the target generating the point whereas the second element represents the ClassID of the target.

Object Functions

To use an object function, specify the System object as the first input argument. For example, to release system resources of a System object named `obj`, use this syntax:

```
release(obj)
```

Specific to `monostaticLidarSensor`

<code>coverageConfig</code>	Sensor and emitter coverage configuration
<code>perturb</code>	Apply perturbations to object
<code>perturbations</code>	Perturbation defined on object

Common to All System Objects

<code>step</code>	Run System object algorithm
<code>release</code>	Release resources and allow changes to System object property values and input characteristics
<code>reset</code>	Reset internal states of System object

Examples

Generate Point Cloud Using `monostaticLidarSensor`

Create a tracking scenario. Add an ego platform and a target platform.

```
scenario = trackingScenario;  
ego = platform(scenario);  
target = platform(scenario, 'Trajectory', kinematicTrajectory('Position', [10 -3 0], 'Velocity', [5 0 0]));
```

Define the geometric mesh of the target. The size of the mesh is adjusted after specifying the target dimensions.

```
target.Mesh = extendedObjectMesh('sphere');  
target.Dimensions.Length = 5;  
target.Dimensions.Width = 3;  
target.Dimensions.Height = 2;
```

Visualize the mesh of the target.

```
show(target.Mesh)
```

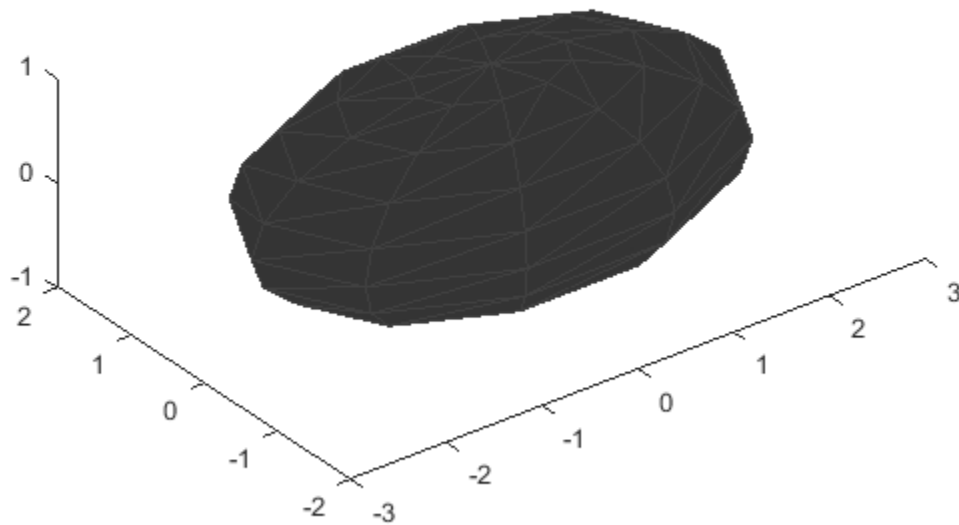
```
ans =
  Axes with properties:
      XLim: [-3 3]
      YLim: [-2 2]
      XScale: 'linear'
      YScale: 'linear'
  GridLineStyle: '-'
  Position: [0.1300 0.1100 0.7750 0.8150]
  Units: 'normalized'
```

Show all properties

Create a `monostaticLidarSensor` with specified `UpdateRate` and `DetectionCoordinates`.

```
sensor = monostaticLidarSensor(1, 'UpdateRate', 10, 'DetectionCoordinates', 'Body');
```

Obtain the mesh of the target viewed from the ego platform after advancing the scenario one step forward.

```
advance(scenario);
tgtmeshes = targetMeshes(ego);
```

Use the created sensor to generate point clouds from the obtained target mesh.

```
time = scenario.SimulationTime;
[ptCloud, config, clusters] = sensor(tgtmeshes, time);
```

Visualize the point cloud detections.

```
figure()  
plot3(ptCloud(:,1),ptCloud(:,2),ptCloud(:,3),'o')
```

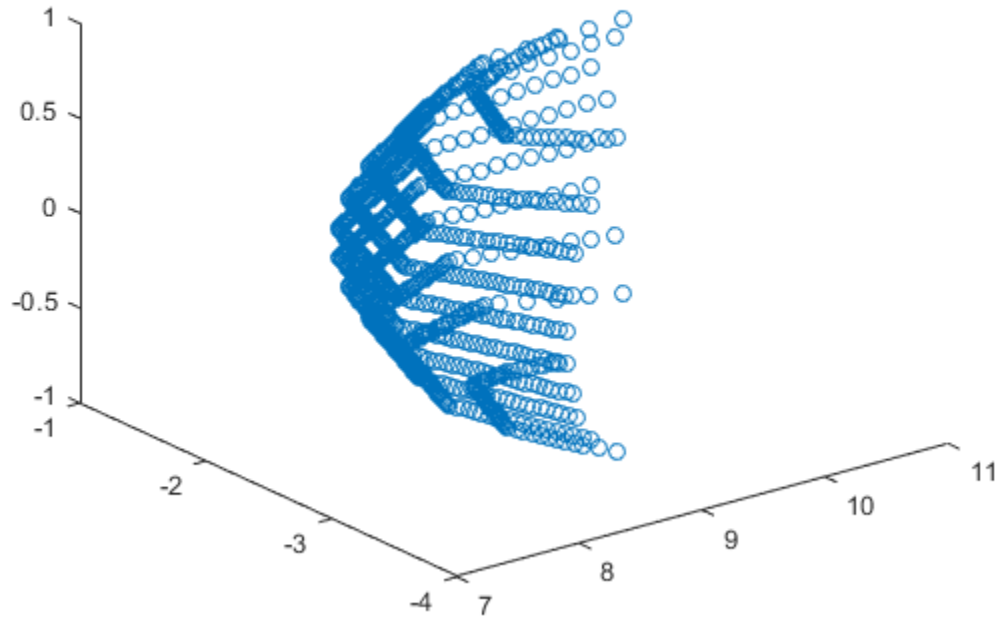

See Also

[extendedObjectMesh](#) | [lidarDetect](#) | [targetMeshes](#)

Introduced in R2020b

trackAssignmentMetrics

Track establishment, maintenance, and deletion metrics

Description

The `trackAssignmentMetrics` System object compares tracks from a multi-object tracking system against known truth by automatic assignment of tracks to the known truths at each track update. An assignment distance metric determines the maximum distance for which a track can be assigned to the truth object. A divergence distance metric determines when a previously assigned track can be reassigned to a different truth object when the distance exceeds another set threshold.

To generate track assignment metrics:

- 1 Create the `trackAssignmentMetrics` object and set its properties.
- 2 Call the object with arguments, as if it were a function.

To learn more about how System objects work, see [What Are System Objects?](#).

Creation

Syntax

```
assignmentMetrics = trackAssignmentMetrics
assignmentMetrics = trackAssignmentMetrics(Name,Value)
```

Description

`assignmentMetrics = trackAssignmentMetrics` creates a `trackAssignmentMetrics` System object, `assignmentMetrics`, with default property values.

`assignmentMetrics = trackAssignmentMetrics(Name,Value)` sets properties for the `trackAssignmentMetrics` object using one or more name-value pairs. For example, `assignmentMetrics = trackAssignmentMetrics('AssignmentThreshold',5)` creates a `trackAssignmentMetrics` object with an assignment threshold of 5. Enclose property names in quotes.

Properties

Unless otherwise indicated, properties are *nontunable*, which means you cannot change their values after calling the object. Objects lock when you call them, and the `release` function unlocks them.

If a property is *tunable*, you can change its value at any time.

For more information on changing property values, see [System Design in MATLAB Using System Objects](#).

AssignmentThreshold — Maximum permitted assignment distance

1 (default) | nonnegative scalar

Maximum permitted assignment distance between a newly encountered or divergent track and a truth object, specified as a nonnegative scalar. For distances beyond this value, assignments between the track and the truth cannot take place. Units are in normalized estimation error squared (NEES).

Data Types: `single` | `double`

DivergenceThreshold — Maximum permitted divergence distance

2 (default) | nonnegative scalar

Maximum permitted divergence distance between a track state and the state of an assigned truth object, specified as a nonnegative scalar. For distances beyond this value, tracks are eligible for reassignment to a different truth object. Units are in NEES.

Data Types: `single` | `double`

DistanceFunctionFormat — Distance function format

'built-in' (default) | 'custom'

Distance function format specified as 'built-in' or 'custom'.

- 'built-in' - Enable the `MotionModel`, `AssignmentDistance`, and `DivergenceDistance` properties. These properties are convenient interfaces when tracks are reported by any built-in multi-object tracker (such as `trackerGNN`), and truths reported by the `platformPoses` object function of a `trackingScenario` object.
- 'custom' - Enable custom properties: `AssignmentDistanceFcn`, `DivergenceDistanceFcn`, `IsInsideCoverageAreaFcn`, `TruthIdentifierFcn`, and `TrackIdentifierFcns`. You can use these properties to construct acceptance or divergence distances, coverage areas, and identifiers for arbitrary 'tracks' and 'truths' input arrays.

MotionModel — Desired platform motion model

'constvel' (default) | 'constacc' | 'constturn' | 'singer'

Desired platform motion model, specified as 'constvel', 'constacc', 'constturn', or 'singer'. This property selects the motion model used by the tracks input.

The motion models expect the 'State' field of the tracks to have a column vector containing these values:

- 'constvel' — Position is in elements [1 3 5], and velocity is in elements [2 4 6].
- 'constacc' — Position is in elements [1 4 7], velocity is in elements [2 5 8], and acceleration is in elements [3 6 9].
- 'constturn' — Position is in elements [1 3 6], velocity is in elements [2 4 7], and yaw rate is in element 5.
- 'singer' — Position is in elements [1 4 7], velocity is in elements [2 5 8], and acceleration is in elements [3 6 9].

The 'StateCovariance' field of the tracks input must have position, velocity, and turn-rate covariances in the rows and columns corresponding to the position, velocity, and turn-rate of the 'State' field of the tracks input.

AssignmentDistance — Type of assignment distance

'posnees' (default) | 'velnees' | 'posabserr' | 'velabserr'

Type of assignment distance, specified as 'posnees', 'velnees', 'posabserr', or 'velabserr'. The type specifies the physical quantity used for assignment. When a new track is detected or a track

becomes divergent, the track is compared against truth using this quantity. The assignment seeks the closest truth within the threshold defined by the `AssignmentThreshold` property.

- 'posnees' - NEES error of track position
- 'velnees' - NEES error in track velocity
- 'posabserr' - Absolute error of track position
- 'velabserr' - Absolute error of track velocity

Dependencies

To enable this property, set the `DistanceFunctionFormat` property to 'built-in'.

DivergenceDistance — Type of assignment distance

'posnees' (default) | 'velnees' | 'posabserr' | 'velabserr'

Type of divergence distance, specified as 'posnees', 'velnees', 'posabserr', or 'velabserr'. The type specifies the physical quantity used for assessing divergence. When a track was previously assigned to truth, the distance between them is compared to this quantity on subsequent update steps. Any track whose divergence distance to its truth assignment exceeds the value of `DivergenceThreshold` is considered divergent and can be reassigned to a new truth.

- 'posnees' - NEES error of track position
- 'velnees' - NEES error in track velocity
- 'posabserr' - Absolute error of track position
- 'velabserr' - Absolute error of track velocity

Dependencies

To enable this property, set the `DistanceFunctionFormat` property to 'built-in'.

AssignmentDistanceFcn — Assignment distance function

function handle

Assignment distance function, specified as a function handle. This function determines the assignment distance between truths and tracks. Whenever a new track is detected or an existing track becomes divergent, the track needs to be compared against all truths at the current step. This function help to find the closest truth relative to the track within the threshold defined by the `AssignmentThreshold` property.

The function must have the following syntax:

```
dist = assignmentdistance(onetrack,onetruth)
```

The function must return a nonnegative assignment distance, `dist`, typically expressed in units of NEES. `onetrack` is an element of the `tracks` array input argument. `onetruth` is an element of the `truths` array input argument.

Dependencies

To enable this property, set the `DistanceFunctionFormat` property to 'custom'.

Data Types: `function_handle`

DivergenceDistanceFcn — Divergence distance function

function handle

Divergence distance function, specified as a function handle. This function determines the divergence distance between truths and tracks. If the divergence distance from a track to its truth assignment exceeds the `DivergenceThreshold`, the track is considered divergent and can be reassigned to a new truth.

The function must have the following syntax:

```
dist = divergencedistance(onetrack,onetruth)
```

The function must return a non-negative divergence distance, `dist`, typically expressed in units of NEES. `onetrack` is an element of the `tracks` array input argument. `onetruth` is an element of the `truths` array input argument.

Dependencies

To enable this property, set the `DistanceFunctionFormat` property to 'custom'.

Data Types: `function_handle`

IsInsideCoverageAreaFcn — Determine the time that a truth object is detectable

function handle

Function to determine the time that a truth object is detectable, specified as a function handle. This function determines the time that a truth object is inside the coverage area of the sensors and is therefore detectable.

The function must have the following syntax:

```
status = isinsidecoveragearea(truths)
```

and return a logical array, `status`. `truths` is an array of truth objects expected to be passed in on each step. `status` is a logical array with the same size as the `truths` input. An entry of `status` is `true` when the corresponding truth object specified by `truths` is within the coverage area of the sensors.

Dependencies

To enable this property, set the `DistanceFunctionFormat` property to 'custom'.

Data Types: `function_handle`

TrackIdentifierFcn — Track identifier function

function handle

Track identifier function for the `tracks` input, specified as a function handle. The track identifiers are unique strings or numeric values.

The function must have the following syntax

```
trackids = trackidentifier(tracks)
```

and return a numeric array, `trackids`. `trackids` must have the same size as `tracks` input argument. The default track identification function assumes `Tracks` is an array of struct or class with a `TrackID` field or property.

Dependencies

To enable this property, set the `DistanceFunctionFormat` property to 'custom'.

Data Types: `function_handle`

TruthIdentifierFcn — Truth identifier function

`function handle`

Truth identifier function for the `truths` input, specified as a function handle. The truth identifiers are unique strings or numeric values.

The function must have the following syntax

```
truthids = truthidentifier(truths)
```

and return a numeric array, `truthids`. `truthids` must have the same size as the `truths` input argument. The default truth identification function assumes `truths` is an array of struct or class with a `PlatformID` field or property.

Dependencies

To enable this property, set the `DistanceFunctionFormat` property to `'custom'`.

Data Types: `function_handle`

InvalidTrackIdentifier — Track identifier for invalid assignment

`NaN (default) | scalar | string`

Track identifier for invalid assignment, specified as a scalar or string. This value is returned when the track assignment is invalid. The value must be of the same class as returned by the function handle specified in `TrackIdentifierFcn`.

Example: `-1`

Data Types: `single | double | string`

InvalidTruthIdentifier — Truth identifier for invalid assignment

`NaN (default) | scalar | string`

Truth identifier for invalid assignment, specified as a scalar or string. This value is returned when the truth assignment is invalid. The value must be of the same class as returned by the function handle specified in `TruthIdentifierFcn`.

Example: `-1`

Data Types: `single | double | string`

Usage

To compute metrics, call the track assignment metrics with arguments, as if it were a function (described here).

Syntax

```
[tracksummary,truthsummary] = assignmentMetrics(tracks,truths)
```

Description

[tracksummary,truthsummary] = assignmentMetrics(tracks,truths) returns structures, tracksummary and truthsummary, containing cumulative metrics across all tracks and truths, obtained from the previous object update.

Input Arguments

tracks — Track information

array of objects | array of structures

Track information, specified as an array of objects or an array of structures. If the DistanceFunctionFormat property is specified as 'built-in', then tracks must contain State, StateCovariance, and TrackID as property names or field names. The track outputs from built-in trackers, such as trackerGNN, are compatible with the tracks input.

Data Types: struct

truths — Truth information

structure | array of structures

Truth information, specified as a structure or array of structures. When using a trackingScenario, truth information can be obtained from the platformPoses object function.

Data Types: struct

Output Arguments

tracksummary — Cumulative track assignment metrics

structure

Cumulative metrics over all tracks, returned as a structure. The metrics are computed over all tracks since the last call to the reset object function. The structure has these fields:

Field	Description
TotalNumTracks	The total number of unique track identifiers encountered
NumFalseTracks	The number of tracks never assigned to any truth
MaxSwapCount	Maximum number of track swaps of each track. A track swap occurs whenever a track is assigned to a different truth.
TotalSwapCount	Total number of track swaps of each track. A track swap occurs whenever a track is assigned to a different truth.
MaxDivergenceCount	Maximum number of divergences. A track is divergent when the result of the DivergenceDistanceFcn is greater than the divergence threshold.
TotalDivergenceCount	Total number of divergences. A track is divergent when the result of the divergence distance function is greater than the divergence threshold.

MaxDivergenceLength	Maximum number of updates during which each track was in a divergent state
TotalDivergenceLength	Total number of updates during which each track was in a divergent state
MaxRedundancyCount	The maximum number of additional tracks assigned to the same truth
TotalRedundancyCount	The total number of additional tracks assigned to the same truth
MaxRedundancyLength	Maximum number of updates during which each track was in a redundant state
TotalRedundancyLength	Total number of updates during which each track was in a redundant state

Data Types: struct

truthsummary – Cumulative truth assignment metrics

structure

Cumulative assignment metrics over all truths, returned as a structure. The metrics are computed over all truths since the last call to the `reset` object function. The structure has these fields:

Field	Description
TotalNumTruths	The total number of unique truth identifiers encountered
NumMissingTruths	The number of truths never established with any track
MaxEstablishmentLength	Maximum number of updates before a truth was associated with any track while inside the coverage area. The lengths of missing truths do not count toward this summary metric.
TotalEstablishmentLength	Total number of updates before a truth was associated with any track while inside the coverage area. The lengths of missing truths do not count toward this summary metric.
MaxBreakCount	Maximum number of times each truth was unassociated by any track after being established.
TotalBreakCount	Total number of times each truth was unassociated by any track after being established.
MaxBreakLength	Maximum number of updates during which each truth was in a broken state
TotalBreakLength	Total number of updates during which each truth was in a broken state

Data Types: struct

Object Functions

To use an object function, specify the System object as the first input argument. For example, to release system resources of a System object named `obj`, use this syntax:

```
release(obj)
```

Specific to `trackAssignmentMetrics`

<code>currentAssignment</code>	Mapping of tracks to truth
<code>trackMetricsTable</code>	Compare tracks to truth
<code>truthMetricsTable</code>	Compare truth to tracks

Common to All System Objects

<code>release</code>	Release resources and allow changes to System object property values and input characteristics
<code>reset</code>	Reset internal states of System object
<code>isLocked</code>	Determine if System object is in use
<code>clone</code>	Create duplicate System object

Examples

Assignment and Error Metrics for Two Tracked Targets

Examine the assignments and errors for a system tracking two targets.

First, load the stored track data.

```
load trackmetricex tracklog truthlog
```

Create objects to analyze assignment and error metrics.

```
tam = trackAssignmentMetrics;  
tem = trackErrorMetrics;
```

Create the output variables.

```
posRMSE = zeros(numel(tracklog),1);  
velRMSE = zeros(numel(tracklog),1);  
posANEES = zeros(numel(tracklog),1);  
velANEES = zeros(numel(tracklog),1);
```

Loop over all tracks to:

- Extract the tracks and ground truth at the i th tracker update.
- Analyze and retrieve the current track-to-truth assignment.
- Analyze instantaneous error metrics over all tracks and truths.

```
for i=1:numel(tracklog)  
    tracks = tracklog{i};  
    truths = truthlog{i};  
    [trackAM,truthAM] = tam(tracks, truths);  
    [trackIDs,truthIDs] = currentAssignment(tam);
```

```

    [posRMSE(i), velRMSE(i), posANEES(i), velANEES(i)] = ...
        tem(tracks, trackIDs, truths, truthIDs);
end

```

Show the track metrics table.

```
trackMetricsTable(tam)
```

```
ans=4×15 table
```

TrackID	AssignedTruthID	Surviving	TotalLength	DeletionStatus	DeletionLength
1	NaN	false	1120	false	0
2	NaN	false	1736	false	0
6	3	true	1138	false	0
8	2	true	662	false	0

Show the truth metrics table.

```
truthMetricsTable(tam)
```

```
ans=2×10 table
```

TruthID	AssociatedTrackID	DeletionStatus	TotalLength	BreakStatus	BreakCount
2	8	false	2678	false	4
3	6	false	2678	false	3

Plot the RMSE and ANEES error metrics.

```

subplot(2,2,1)
plot(posRMSE)
title('Position Error')
xlabel('tracker update')
ylabel('RMSE (m)')

subplot(2,2,2)
plot(velRMSE)
title('Velocity Error')
xlabel('tracker update')
ylabel('RMSE (m/s)')

subplot(2,2,3)
plot(posANEES)
title('Position Error')
xlabel('tracker update')
ylabel('ANEES')

subplot(2,2,4)
plot(velANEES)
title('Velocity Error')
xlabel('tracker update')
ylabel('ANEES')

```

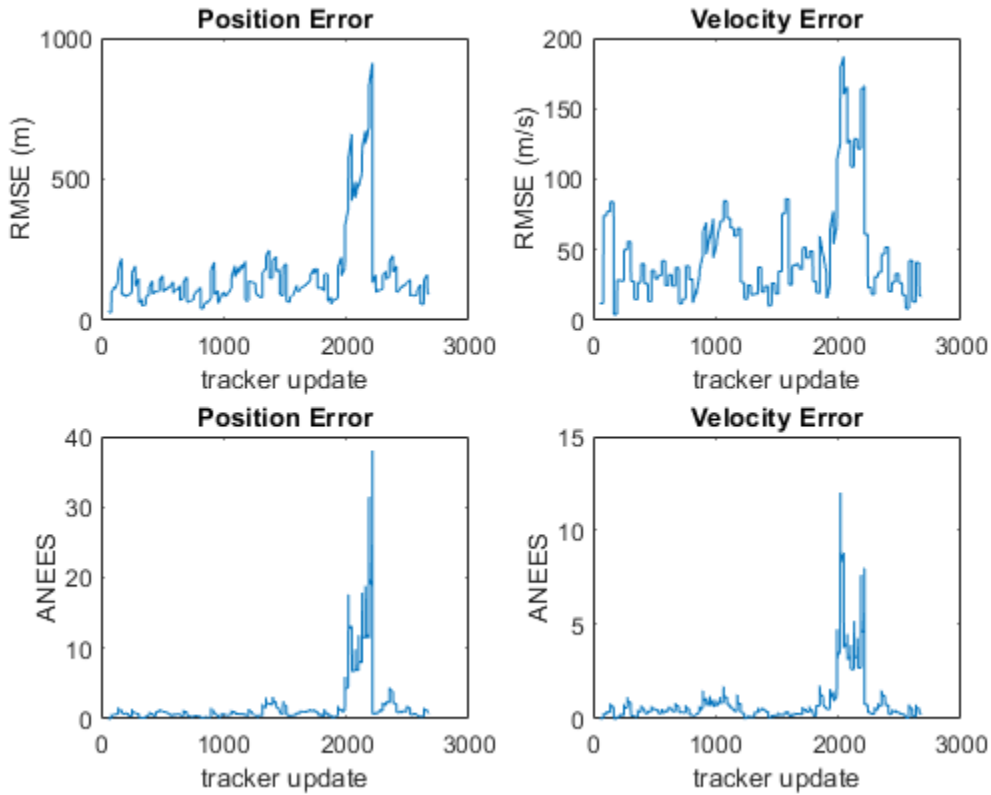

Show the current error metrics for each individual recorded track.

```
currentTrackMetrics(tem)
```

ans=2x5 table

TrackID	posRMS	velRMS	posANEES	velANEES
6	44.712	20.988	0.05974	0.31325
8	129.26	12.739	1.6745	0.2453

Show the current error metrics for each individual recorded truth object.

```
currentTruthMetrics(tem)
```

ans=2x5 table

TruthID	posRMS	velRMS	posANEES	velANEES
2	129.26	12.739	1.6745	0.2453
3	44.712	20.988	0.05974	0.31325

Show the cumulative error metrics for each individual recorded track.

```
cumulativeTrackMetrics(tem)
```

ans=4x5 table

TrackID	posRMS	velRMS	posANEES	velANEES
1	117.69	43.951	0.58338	0.44127
2	129.7	42.8	0.81094	0.42509
6	371.35	87.083	4.5208	1.6952
8	130.45	53.914	1.0448	0.44813

Show the cumulative error metrics for each individual recorded truth object.

cumulativeTruthMetrics(tem)

ans=2x5 table

TruthID	posRMS	velRMS	posANEES	velANEES
2	258.21	65.078	2.2514	0.93359
3	134.41	48.253	0.96314	0.49183

See Also

Objects

fusionRadarSensor | trackErrorMetrics | trackOSPAMetric | trackerGNN | trackerTOMHT

Introduced in R2018b

currentAssignment

Mapping of tracks to truth

Syntax

```
[trackIDs,truthIDs] = currentAssignment(assignmentMetric)
```

Description

`[trackIDs,truthIDs] = currentAssignment(assignmentMetric)` returns the assignment of tracks to truth after the most recent update of the `assignmentMetric` System object. The assignment is returned as a vector of track identifiers, `trackIDs`, and truth identifiers, `truthIDs`. Corresponding elements of the `trackIDs` and `truthIDs` vectors define the assignments.

Examples

Assignment and Error Metrics for Two Tracked Targets

Examine the assignments and errors for a system tracking two targets.

First, load the stored track data.

```
load trackmetricex tracklog truthlog
```

Create objects to analyze assignment and error metrics.

```
tam = trackAssignmentMetrics;  
tem = trackErrorMetrics;
```

Create the output variables.

```
posRMSE = zeros(numel(tracklog),1);  
velRMSE = zeros(numel(tracklog),1);  
posANEES = zeros(numel(tracklog),1);  
velANEES = zeros(numel(tracklog),1);
```

Loop over all tracks to:

- Extract the tracks and ground truth at the i th tracker update.
- Analyze and retrieve the current track-to-truth assignment.
- Analyze instantaneous error metrics over all tracks and truths.

```
for i=1:numel(tracklog)  
    tracks = tracklog{i};  
    truths = truthlog{i};  
    [trackAM,truthAM] = tam(tracks, truths);  
    [trackIDs,truthIDs] = currentAssignment(tam);  
    [posRMSE(i),velRMSE(i),posANEES(i),velANEES(i)] = ...  
        tem(tracks,trackIDs,truths,truthIDs);  
end
```

Show the track metrics table.

```
trackMetricsTable(tam)
```

ans=4×15 table

TrackID	AssignedTruthID	Surviving	TotalLength	DeletionStatus	DeletionLength
1	NaN	false	1120	false	0
2	NaN	false	1736	false	0
6	3	true	1138	false	0
8	2	true	662	false	0

Show the truth metrics table.

```
truthMetricsTable(tam)
```

ans=2×10 table

TruthID	AssociatedTrackID	DeletionStatus	TotalLength	BreakStatus	BreakCount
2	8	false	2678	false	4
3	6	false	2678	false	3

Plot the RMSE and ANEES error metrics.

```
subplot(2,2,1)
plot(posRMSE)
title('Position Error')
xlabel('tracker update')
ylabel('RMSE (m)')
```

```
subplot(2,2,2)
plot(velRMSE)
title('Velocity Error')
xlabel('tracker update')
ylabel('RMSE (m/s)')
```

```
subplot(2,2,3)
plot(posANEES)
title('Position Error')
xlabel('tracker update')
ylabel('ANEES')
```

```
subplot(2,2,4)
plot(velANEES)
title('Velocity Error')
xlabel('tracker update')
ylabel('ANEES')
```

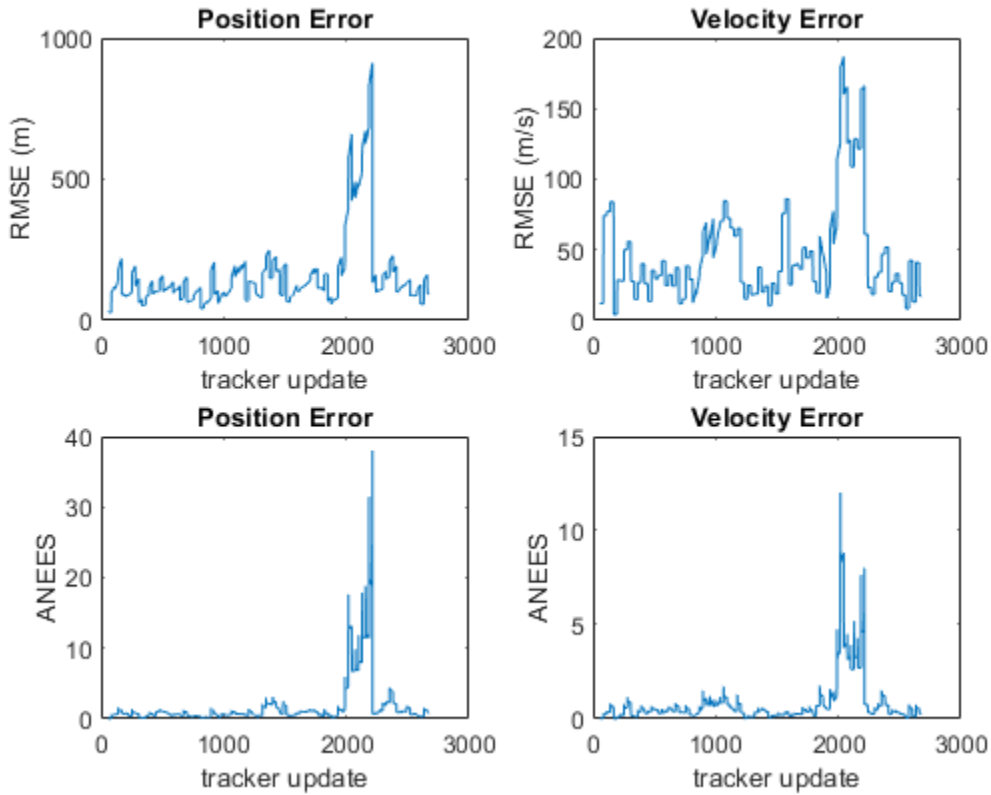

Show the current error metrics for each individual recorded track.

```
currentTrackMetrics(tem)
```

ans=2x5 table

TrackID	posRMS	velRMS	posANEES	velANEES
6	44.712	20.988	0.05974	0.31325
8	129.26	12.739	1.6745	0.2453

Show the current error metrics for each individual recorded truth object.

```
currentTruthMetrics(tem)
```

ans=2x5 table

TruthID	posRMS	velRMS	posANEES	velANEES
2	129.26	12.739	1.6745	0.2453
3	44.712	20.988	0.05974	0.31325

Show the cumulative error metrics for each individual recorded track.

```
cumulativeTrackMetrics(tem)
```



```
ans=4x5 table
  TrackID   posRMS   velRMS   posANEES   velANEES
  -----   -----   -----   -----   -----
      1     117.69    43.951    0.58338    0.44127
      2      129.7     42.8     0.81094    0.42509
      6     371.35    87.083    4.5208     1.6952
      8     130.45    53.914    1.0448     0.44813
```

Show the cumulative error metrics for each individual recorded truth object.

```
cumulativeTruthMetrics(tem)
```

```
ans=2x5 table
  TruthID   posRMS   velRMS   posANEES   velANEES
  -----   -----   -----   -----   -----
      2     258.21    65.078    2.2514     0.93359
      3     134.41    48.253    0.96314    0.49183
```

Input Arguments

assignmentMetric — Track assignment metrics object

`trackAssignmentMetrics` System object

Track assignment metrics object, specified as a `trackAssignmentMetrics` System object.

Output Arguments

trackIDs — Track identifiers

vector

Track identifiers, returned as a vector. `trackIDs` and `truthIDs` have the same size. Corresponding elements of `trackIDs` and `truthIDs` represent a track-truth assignment.

truthIDs — Truth identifiers

vector

Truth identifiers, returned as a vector. `trackIDs` and `truthIDs` have the same size. Corresponding elements of `trackIDs` and `truthIDs` represent a track-truth assignment.

Introduced in R2018b

trackMetricsTable

Compare tracks to truth

Syntax

```
metricsTable = trackMetricsTable(assignmentMetric)
```

Description

`metricsTable = trackMetricsTable(assignmentMetric)` returns a table of metrics, `metricsTable`, for all tracks in the track assignment metrics object, `assignmentMetric`.

Examples

Assignment and Error Metrics for Two Tracked Targets

Examine the assignments and errors for a system tracking two targets.

First, load the stored track data.

```
load trackmetricex tracklog truthlog
```

Create objects to analyze assignment and error metrics.

```
tam = trackAssignmentMetrics;  
tem = trackErrorMetrics;
```

Create the output variables.

```
posRMSE = zeros(numel(tracklog),1);  
velRMSE = zeros(numel(tracklog),1);  
posANEES = zeros(numel(tracklog),1);  
velANEES = zeros(numel(tracklog),1);
```

Loop over all tracks to:

- Extract the tracks and ground truth at the i th tracker update.
- Analyze and retrieve the current track-to-truth assignment.
- Analyze instantaneous error metrics over all tracks and truths.

```
for i=1:numel(tracklog)  
    tracks = tracklog{i};  
    truths = truthlog{i};  
    [trackAM,truthAM] = tam(tracks, truths);  
    [trackIDs,truthIDs] = currentAssignment(tam);  
    [posRMSE(i),velRMSE(i),posANEES(i),velANEES(i)] = ...  
        tem(tracks,trackIDs,truths,truthIDs);  
end
```

Show the track metrics table.

```
trackMetricsTable(tam)
```

```
ans=4x15 table
```

TrackID	AssignedTruthID	Surviving	TotalLength	DeletionStatus	DeletionLength
1	NaN	false	1120	false	0
2	NaN	false	1736	false	0
6	3	true	1138	false	0
8	2	true	662	false	0

Show the truth metrics table.

```
truthMetricsTable(tam)
```

```
ans=2x10 table
```

TruthID	AssociatedTrackID	DeletionStatus	TotalLength	BreakStatus	BreakCount
2	8	false	2678	false	4
3	6	false	2678	false	3

Plot the RMSE and ANEES error metrics.

```
subplot(2,2,1)
plot(posRMSE)
title('Position Error')
xlabel('tracker update')
ylabel('RMSE (m)')
```

```
subplot(2,2,2)
plot(velRMSE)
title('Velocity Error')
xlabel('tracker update')
ylabel('RMSE (m/s)')
```

```
subplot(2,2,3)
plot(posANEES)
title('Position Error')
xlabel('tracker update')
ylabel('ANEES')
```

```
subplot(2,2,4)
plot(velANEES)
title('Velocity Error')
xlabel('tracker update')
ylabel('ANEES')
```

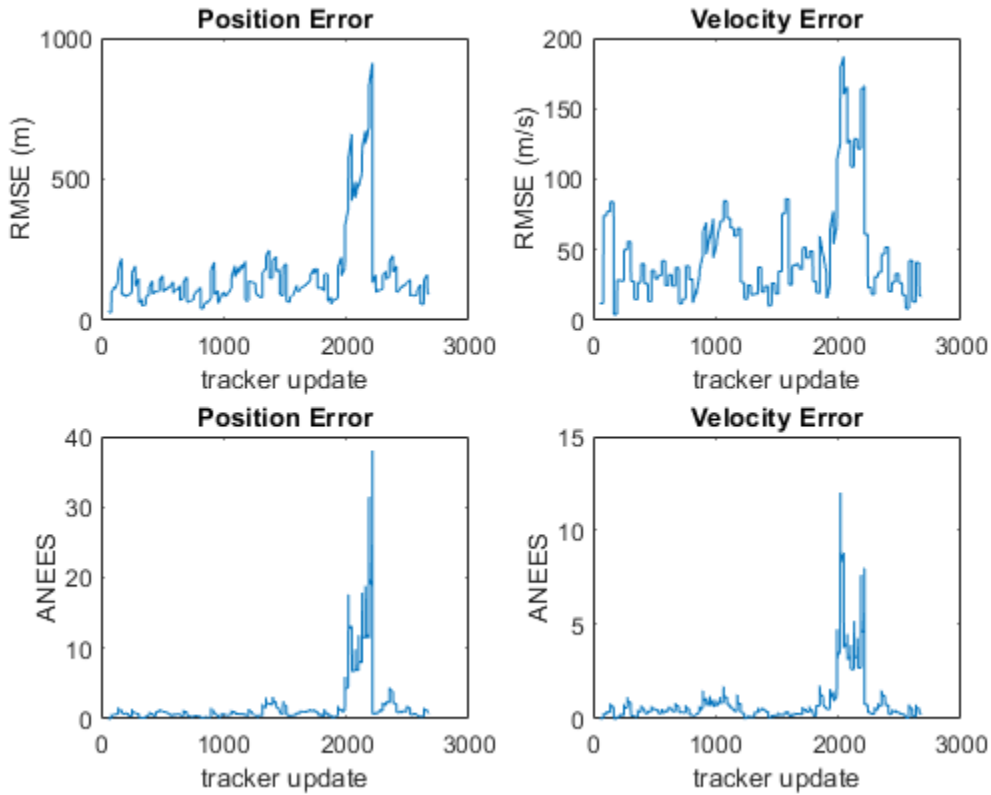

Show the current error metrics for each individual recorded track.

```
currentTrackMetrics(tem)
```

ans=2x5 table

TrackID	posRMS	velRMS	posANEES	velANEES
6	44.712	20.988	0.05974	0.31325
8	129.26	12.739	1.6745	0.2453

Show the current error metrics for each individual recorded truth object.

```
currentTruthMetrics(tem)
```

ans=2x5 table

TruthID	posRMS	velRMS	posANEES	velANEES
2	129.26	12.739	1.6745	0.2453
3	44.712	20.988	0.05974	0.31325

Show the cumulative error metrics for each individual recorded track.

```
cumulativeTrackMetrics(tem)
```

```
ans=4x5 table
  TrackID    posRMS    velRMS    posANEES    velANEES
  -----
      1      117.69    43.951    0.58338    0.44127
      2       129.7     42.8     0.81094    0.42509
      6      371.35    87.083    4.5208     1.6952
      8      130.45    53.914    1.0448     0.44813
```

Show the cumulative error metrics for each individual recorded truth object.

```
cumulativeTruthMetrics(tem)
```

```
ans=2x5 table
  TruthID    posRMS    velRMS    posANEES    velANEES
  -----
      2      258.21    65.078    2.2514     0.93359
      3      134.41    48.253    0.96314    0.49183
```

Input Arguments

assignmentMetric — Track assignment metrics object

trackAssignmentMetrics System object

Track assignment metrics object, specified as a `trackAssignmentMetrics` System object.

Output Arguments

metricsTable — Track metrics table

table

Track metrics table, returned as a table. Each row of the table represents a track. The table has these columns:

Column	Description
TrackID	Unique track identifier
AssignedTruthID	Unique truth identifier. If the track is not assigned to any truth, or the track was not reported in the last update, then the value of AssignedTruthID is NaN.
Surviving	True if the track was reported in the last update
TotalLength	Number of updates in which this track was reported
DeletionStatus	True if the track was previously assigned to a truth that was deleted while inside its coverage area.

DeletionLength	The number of updates in which the track was following a deleted truth
DivergenceStatus	True when the divergence distance between this track and its corresponding truth exceeds the divergence threshold
DivergenceCount	Number of times this track entered a divergent state
DivergenceLength	Number of updates in which this track was in a divergent state
RedundancyStatus	True if this track is assigned to a truth already associated with another track
RedundancyCount	Number of times this track entered a redundant state
RedundancyLength	Number of updates for which this track was in a redundant state
FalseTrackStatus	True if the track was not assigned to any truth
FalseTrackLength	Number of updates in which the track was unassigned
SwapCount	Number of times the track was assigned to a new truth object

Introduced in R2018b

truthMetricsTable

Compare truth to tracks

Syntax

```
metricsTable = truthMetricsTable(assignmentMetric)
```

Description

`metricsTable = truthMetricsTable(assignmentMetric)` returns a table of metrics, `metricsTable`, for all truths in the `assignmentMetric` System object.

Examples

Assignment and Error Metrics for Two Tracked Targets

Examine the assignments and errors for a system tracking two targets.

First, load the stored track data.

```
load trackmetricex tracklog truthlog
```

Create objects to analyze assignment and error metrics.

```
tam = trackAssignmentMetrics;
tem = trackErrorMetrics;
```

Create the output variables.

```
posRMSE = zeros(numel(tracklog),1);
velRMSE = zeros(numel(tracklog),1);
posANEES = zeros(numel(tracklog),1);
velANEES = zeros(numel(tracklog),1);
```

Loop over all tracks to:

- Extract the tracks and ground truth at the i th tracker update.
- Analyze and retrieve the current track-to-truth assignment.
- Analyze instantaneous error metrics over all tracks and truths.

```
for i=1:numel(tracklog)
    tracks = tracklog{i};
    truths = truthlog{i};
    [trackAM,truthAM] = tam(tracks, truths);
    [trackIDs,truthIDs] = currentAssignment(tam);
    [posRMSE(i),velRMSE(i),posANEES(i),velANEES(i)] = ...
        tem(tracks,trackIDs,truths,truthIDs);
end
```

Show the track metrics table.

```
trackMetricsTable(tam)
```

```
ans=4x15 table
```

TrackID	AssignedTruthID	Surviving	TotalLength	DeletionStatus	DeletionLength
1	NaN	false	1120	false	0
2	NaN	false	1736	false	0
6	3	true	1138	false	0
8	2	true	662	false	0

Show the truth metrics table.

```
truthMetricsTable(tam)
```

```
ans=2x10 table
```

TruthID	AssociatedTrackID	DeletionStatus	TotalLength	BreakStatus	BreakCount
2	8	false	2678	false	4
3	6	false	2678	false	3

Plot the RMSE and ANEES error metrics.

```
subplot(2,2,1)
plot(posRMSE)
title('Position Error')
xlabel('tracker update')
ylabel('RMSE (m)')

subplot(2,2,2)
plot(velRMSE)
title('Velocity Error')
xlabel('tracker update')
ylabel('RMSE (m/s)')

subplot(2,2,3)
plot(posANEES)
title('Position Error')
xlabel('tracker update')
ylabel('ANEES')

subplot(2,2,4)
plot(velANEES)
title('Velocity Error')
xlabel('tracker update')
ylabel('ANEES')
```

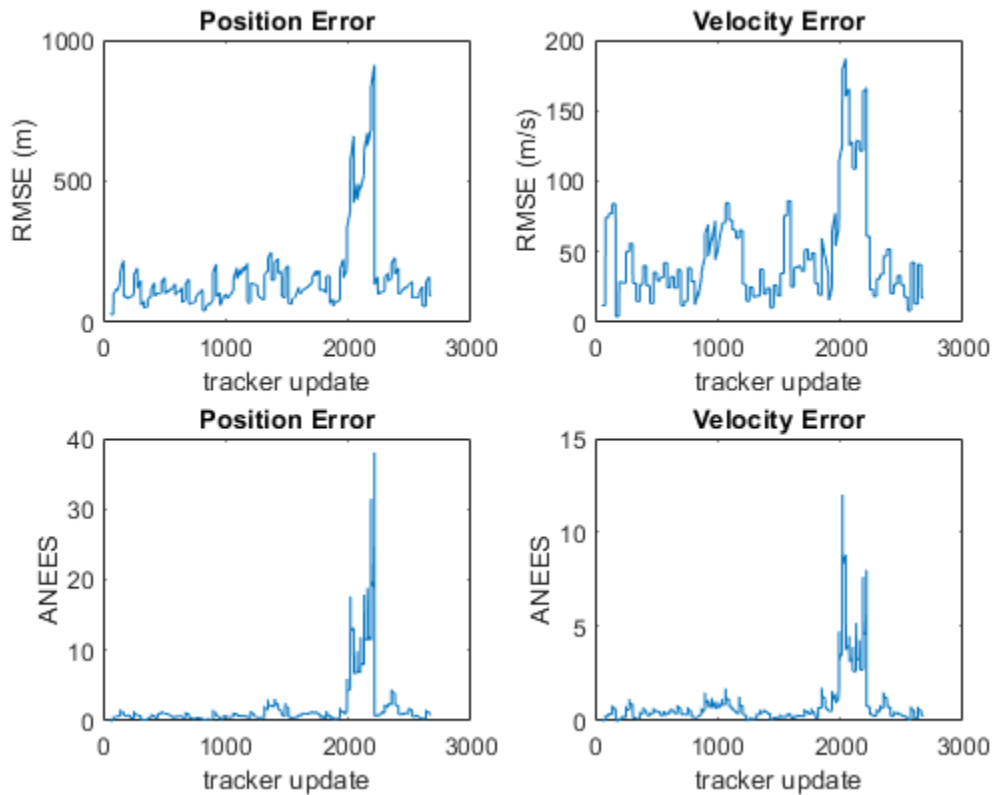
Show the current error metrics for each individual recorded track.

```
currentTrackMetrics(tem)
```

```
ans=2x5 table
```

TrackID	posRMS	velRMS	posANEES	velANEES
6	44.712	20.988	0.05974	0.31325
8	129.26	12.739	1.6745	0.2453

Show the current error metrics for each individual recorded truth object.

```
currentTruthMetrics(tem)
```

```
ans=2x5 table
```

TruthID	posRMS	velRMS	posANEES	velANEES
2	129.26	12.739	1.6745	0.2453
3	44.712	20.988	0.05974	0.31325

Show the cumulative error metrics for each individual recorded track.

```
cumulativeTrackMetrics(tem)
```

```
ans=4x5 table
  TrackID    posRMS    velRMS    posANEES    velANEES
  _____  _____  _____  _____  _____
      1      117.69    43.951    0.58338    0.44127
      2       129.7     42.8     0.81094    0.42509
      6      371.35    87.083    4.5208     1.6952
      8      130.45    53.914    1.0448     0.44813
```

Show the cumulative error metrics for each individual recorded truth object.

```
cumulativeTruthMetrics(tem)
```

```
ans=2x5 table
  TruthID    posRMS    velRMS    posANEES    velANEES
  _____  _____  _____  _____  _____
      2      258.21    65.078    2.2514     0.93359
      3      134.41    48.253    0.96314    0.49183
```

Input Arguments

assignmentMetric — Track assignment metrics object

`trackAssignmentMetrics` System object

Track assignment metrics object, specified as a `trackAssignmentMetrics` System object.

Output Arguments

metricsTable — Truth metrics table

table

Truth metrics table, returned as a table. Each row of the table represents a truth. The table has these columns:

TruthID	Unique truth identifier
AssignedTrackID	Unique identifier of the associated track
DeletionStatus	False if the truth was reported in the last update
TotalLength	Number of updates this truth was reported
DeletionLength	The number of updates in which the track was following a deleted truth
BreakStatus	True when an established truth no longer has any track assigned with it
BreakCount	Number of times this truth entered a broken state
BreakLength	Number of updates in which this truth was in a broken state

InCoverageArea	True if this truth object is inside the coverage area
EstablishmentStatus	True if the truth is associated to any track
EstablishmentLength	Number of updates before this truth was associated to any track while inside the coverage area

Introduced in R2018b

trackErrorMetrics

Track error and NEES

Description

The `trackErrorMetrics` System object provides quantitative comparisons between tracks and known truth trajectories.

To generate track assignment metrics:

- 1 Create the `trackErrorMetrics` object and set its properties.
- 2 Call the object with arguments, as if it were a function.

To learn more about how System objects work, see [What Are System Objects?](#).

Creation

Syntax

```
errorMetrics = trackErrorMetrics  
errorMetrics = trackErrorMetrics(Name,Value)
```

Description

`errorMetrics = trackErrorMetrics` creates a `trackErrorMetrics` System object with default property values.

`errorMetrics = trackErrorMetrics(Name,Value)` sets properties for the `trackErrorMetrics` object using one or more name-value pairs. For example, `metrics = trackErrorMetrics('MotionModel','constvel')` creates a `trackErrorMetrics` object with a constant velocity motion model. Enclose property names in quotes.

Properties

Unless otherwise indicated, properties are *nontunable*, which means you cannot change their values after calling the object. Objects lock when you call them, and the `release` function unlocks them.

If a property is *tunable*, you can change its value at any time.

For more information on changing property values, see [System Design in MATLAB Using System Objects](#).

ErrorFunctionFormat — Error function format

```
'built-in' (default) | 'custom'
```

Error function format specified as `'built-in'` or `'custom'`.

- 'built-in' - Enable the `MotionModel` property.

This property is a convenient interface when using tracks reported by any built-in multi-object tracker, and truths reported by the `platformPoses` object function of a `trackingScenario` object. The default estimation error function assumes tracks and truths are arrays of structures or arrays of objects.

- 'custom' - Enable custom properties: `EstimationErrorLabels`, `EstimationErrorFcn`, `TruthIdentifierFcn`, and `TrackIdentifierFcns`. These properties can be used to construct error functions for arbitrary tracks and truths input arrays.

MotionModel — Desired platform motion model

'constvel' (default) | 'constacc' | 'constturn' | 'singer'

Desired platform motion model, specified as 'constvel', 'constacc', 'constturn', or 'singer'. This property selects the motion model used by the `tracks` input.

The motion models expect the 'State' field of the `tracks` to have a column vector containing these values:

- 'constvel' — Position is in elements [1 3 5], and velocity is in elements [2 4 6].
- 'constacc' — Position is in elements [1 4 7], velocity is in elements [2 5 8], and acceleration is in elements [3 6 9].
- 'constturn' — Position is in elements [1 3 6], velocity is in elements [2 4 7], and yaw rate is in element 5.
- 'singer' — Position is in elements [1 4 7], velocity is in elements [2 5 8], and acceleration is in elements [3 6 9].

The 'StateCovariance' field of the `tracks` input must have position, velocity, and turn-rate covariances in the rows and columns corresponding to the position, velocity, and turn-rate of the 'State' field of the `tracks` input.

EstimationErrorLabels — Labels for outputs of error estimation function

'posMSE' (default) | array of strings | cell array of character vectors

Labels for outputs of error estimation function, specified as an array of strings or cell array of character vectors. The number of labels must correspond to the number of outputs of the error estimation function. Specify the error estimation functions using the `EstimationErrorFcn` property.

Example: {'posMSE', 'velMSE'}

Dependencies

To enable this property, set the `ErrorFunctionFormat` property to 'custom'.

Data Types: char | string

EstimationErrorFcn — Error estimation function

function handle

Error estimation function, specified as a function handle. The function determines estimation errors of truths to tracks.

The error estimation function can have multiple scalar outputs and must have the following syntax.

```
[out1,out2, ...,outN] = estimationerror(onetrack,onetruth)
```

The number of outputs must match the number of entries in the labels array specified in the EstimationErrorLabels property.

onetrack is an element of the tracks array passed in as input trackErrorMetric at object updates. onetruth is an element of the truths array passed in at object updates. The trackErrorMetrics object averages each output arithmetically when reporting across tracks or truths.

Example: @errorFunction

Dependencies

To enable this property, set the ErrorFunctionFormat property to 'custom'.

Data Types: function_handle

TrackIdentifierFcn — Track identifier function

@trackIDFunction (default) | function handle

Track identifier function, specified as a function handle. Specifies the track identifiers for the tracks input at object update. The track identifiers are unique string or numeric values.

The track identifier function must have the following syntax:

```
trackID = trackIdentifier(tracks)
```

tracks is the same as the tracks array passed as input for trackErrorMetric at object update. trackID is the same size as tracks. The default identification function handle, @defaultTrackIdentifier, assumes tracks is an array of structures or objects with a 'TrackID' field name or property.

Dependencies

To enable this property, set the ErrorFunctionFormat property to 'custom'.

Data Types: function_handle

TruthIdentifierFcn — Truth identifier function

@truthIDFunction (default) | function handle

Truth identifier function, specified as a function handle. Specifies the truth identifiers for the truths input at object update. The truth identifiers are unique string or numeric values.

The truth identifier function must have the following syntax:

```
truthID = truthIdentifier(truths)
```

truths is the same as the truths array passed as input for trackErrorMetric updates. truthID must have the same size as truths. The default identification function handle, @defaultTruthIdentifier, assumes truths is an array or structures or objects with a 'PlatformID' field name or property.

Dependencies

To enable this property, set the ErrorFunctionFormat property to 'custom'.

Data Types: function_handle

Usage

To estimate errors, call the track error metrics object with arguments, as if it were a function (described here).

Syntax

```
[posRMSE, velRMSE, posANEES, velANEES] = errorMetrics(tracks, trackIDs, truths, truthIDs)
```

```
[posRMSE, velRMSE, accRMSE, posANEES, velANEES, accANEES] = errorMetrics(tracks, trackIDs, truths, truthIDs)
```

```
[posRMSE, velRMSE, yawRateRMSE, posANEES, velANEES, yawRateANEES] = errorMetrics(tracks, trackIDs, truths, truthIDs)
```

```
[out1, out2, ... , outN] = errorMetrics(tracks, trackIDs, truths, truthIDs)
```

Description

[posRMSE, velRMSE, posANEES, velANEES] = errorMetrics(tracks, trackIDs, truths, truthIDs) returns the metrics

- posRMSE - Position root mean squared error
- velRMSE - Velocity root mean squared error
- posANEES - Position average normalized-estimation error squared
- velANEES - Velocity average normalized-estimation error squared

for constant velocity motion at the current time step. `trackIDs` is the set of track identifiers for all tracks. `truthIDs` is the set of truth identifiers. `tracks` are the set of tracks, and `truths` are the set of truths. `trackIDs` and `truthIDs` are each a vector whose corresponding elements match the track and truth identifiers found in `tracks` and `truths`, respectively.

The RMSE and ANEES values for different states are calculated by averaging the errors of all tracks at the current time step. For example, the position RMSE value, `posRMSE`, is defined as:

$$\text{posRMSE} = \sqrt{\frac{1}{M} \sum_{i=1}^M \|\Delta p_i\|^2}$$

where M is the total number of tracks with associated truth trajectories in the current time step, and

$$\Delta p_i = p_{\text{track},i} - p_{\text{truth},i}$$

is the position difference between the position of track i , $p_{\text{track},i}$ and the position of the corresponding truth, $p_{\text{truth},i}$, at the current time step. The RMSE values for other states (`vel`, `pos`, `acc`, and `yawRate`) are defined similarly.

The position ANEES value, `posANEES`, is defined as:

$$\text{posANEES} = \frac{1}{M} \sum_{i=1}^M \Delta p_i^T C_{p,i}^{-1} \Delta p_i$$

where $C_{p,i}$ is the covariance matrix corresponding to the position of track i at the current time step. The ANEES values for other states (`vel`, `pos`, `acc`, and `yawRate`) are defined similarly.

To enable this syntax, set the `ErrorFunctionFormat` property to 'built-in' and the `MotionModel` property to 'constvel'.

`[posRMSE, velRMSE, accRMSE, posANEES, velANEES, accANEES] = errorMetrics(tracks, trackIDs, truths, truthIDs)` also returns the metrics

- `accRMS` - Acceleration root mean squared error
- `accANEES` - acceleration average normalized-estimation error squared

for constant acceleration motion at the current time step.

To enable this syntax, set the `ErrorFunctionFormat` property to 'built-in' and the `MotionModel` property to 'constacc'.

`[posRMSE, velRMSE, yawRateRMSE, posANEES, velANEES, yawRateANEES] = errorMetrics(tracks, trackIDs, truths, truthIDs)` also returns the metrics

- `yawRateRMSE` - yaw rate root mean squared error
- `yawRateANEES` - yaw rate average normalized-estimation error squared

for constant turn-rate motion at the current time step.

To enable this syntax, set the `ErrorFunctionFormat` property to 'built-in' and the `MotionModel` property to 'constturn'.

`[out1, out2, ... , outN] = errorMetrics(tracks, trackIDs, truths, truthIDs)` returns the user-defined metrics `out1`, `out2`, ... , `outN`.

To enable this syntax, set the `ErrorFunctionFormat` property to 'custom'. The number of outputs corresponds to the number of elements listed in the `EstimationErrorLabels` property, and must match the number of outputs in the `EstimationErrorFcn`. The results of the estimation errors are averaged arithmetically over all track-to-truth assignments.

Tip These usage syntaxes only calculate the RMSE and ANEES values of all tracks with associated truths at the current time step. To obtain the cumulative RMSE and ANEES values for each track and truth, use the `cumulativeTrackMetrics` and `cumulativeTruthMetrics` object functions, respectively. To obtain the current RMSE and ANEES values for each track and truth, use the `currentTrackMetrics` and `currentTruthMetrics` object functions, respectively.

Input Arguments

tracks — Track information

array of structures | array of objects

Track information, specified as an array of structures or objects. For built-in trackers such as `trackerGNN` or `trackerTOMHT`, the `objectTrack` output contains 'State', 'StateCovariance', and 'TrackID' information.

Data Types: `struct`

trackIDs — Track identifiers

real-valued vector

Track identifiers, specified as a real-valued vector. `trackIDs` elements match the tracks found in `tracks`.

truths — Truth information

array of structures | array of objects

Truth information, specified as an array of structures or objects. When using a `trackingScenario`, truth information can be obtained from the `platformPoses` object function.

Data Types: `struct`

truthIDs — Truth identifiers

real-valued vector

Truth identifiers, specified as a real-valued vector. `truthIDs` elements match the truths found in `truths`.

Output Arguments

posRMSE — Position root mean squared error

scalar

Position root mean squared error for all tracks associated with truths, returned as a scalar.

Dependencies

To enable this argument, set the `ErrorFunctionFormat` property to `'built-in'`.

velRMSE — Velocity root mean squared error

scalar

Velocity root mean squared error for all tracks associated with truths, returned as a scalar.

Dependencies

To enable this argument, set the `ErrorFunctionFormat` property to `'built-in'`.

accRMSE — Acceleration root mean squared error

scalar

Acceleration root mean squared error for all tracks associated with truths, returned as a scalar.

Dependencies

To enable this argument, set the `ErrorFunctionFormat` property to `'built-in'`.

yawRateRMSE — Yaw rate root mean squared error

scalar

Yaw rate root mean squared error for all tracks associated with truths, returned as a scalar.

Dependencies

To enable this argument, set the `ErrorFunctionFormat` property to `'built-in'`.

posANEES — Position average normalized estimation error squared

scalar

Position average normalized estimation error squared for all tracks associated with truths, returned as a scalar.

Dependencies

To enable this argument, set the `ErrorFunctionFormat` property to 'built-in'.

velANEES — Velocity average normalized estimation error squared

scalar

Velocity average normalized estimation error squared for all tracks associated with truths, returned as a scalar.

Dependencies

To enable this argument, set the `ErrorFunctionFormat` property to 'built-in'.

accANEES — Acceleration average normalized estimation error squared

scalar

Acceleration average normalized estimation error squared for all tracks associated with truths, returned as a scalar.

Dependencies

To enable this argument, set the `ErrorFunctionFormat` property to 'built-in'.

yawRateANEES — Yaw rate average normalized estimation error squared

scalar

Yaw rate average normalized estimation error squared for all tracks associated with truths, returned as a scalar.

Dependencies

To enable this argument, set the `ErrorFunctionFormat` property to 'built-in'.

out1, out2, outN — Custom error metric outputs

scalar

Custom error metric outputs, returned as scalars. These errors are the output of the error estimation function specified in the `EstimationErrorFcn` property.

Dependencies

To enable these arguments, set the `ErrorFunctionFormat` property to 'custom'.

Object Functions

To use an object function, specify the System object as the first input argument. For example, to release system resources of a System object named `obj`, use this syntax:

```
release(obj)
```

Specific to trackErrorMetrics

`cumulativeTrackMetrics` Cumulative metrics for recent tracks

cumulativeTruthMetrics Cumulative metrics for recent truths
 currentTrackMetrics Metrics for recent tracks
 currentTruthMetrics Metrics for recent truths

Common to All System Objects

release Release resources and allow changes to System object property values and input characteristics
 reset Reset internal states of System object
 isLocked Determine if System object is in use
 clone Create duplicate System object

Examples

Assignment and Error Metrics for Two Tracked Targets

Examine the assignments and errors for a system tracking two targets.

First, load the stored track data.

```
load trackmetricex tracklog truthlog
```

Create objects to analyze assignment and error metrics.

```
tam = trackAssignmentMetrics;  
tem = trackErrorMetrics;
```

Create the output variables.

```
posRMSE = zeros(numel(tracklog),1);  
velRMSE = zeros(numel(tracklog),1);  
posANEES = zeros(numel(tracklog),1);  
velANEES = zeros(numel(tracklog),1);
```

Loop over all tracks to:

- Extract the tracks and ground truth at the i th tracker update.
- Analyze and retrieve the current track-to-truth assignment.
- Analyze instantaneous error metrics over all tracks and truths.

```
for i=1:numel(tracklog)  
    tracks = tracklog{i};  
    truths = truthlog{i};  
    [trackAM,truthAM] = tam(tracks, truths);  
    [trackIDs,truthIDs] = currentAssignment(tam);  
    [posRMSE(i),velRMSE(i),posANEES(i),velANEES(i)] = ...  
        tem(tracks,trackIDs,truths,truthIDs);  
end
```

Show the track metrics table.

```
trackMetricsTable(tam)
```

```
ans=4x15 table  
    TrackID    AssignedTruthID    Surviving    TotalLength    DeletionStatus    DeletionLength
```

1	NaN	false	1120	false	0
2	NaN	false	1736	false	0
6	3	true	1138	false	0
8	2	true	662	false	0

Show the truth metrics table.

```
truthMetricsTable(tam)
```

```
ans=2x10 table
```

TruthID	AssociatedTrackID	DeletionStatus	TotalLength	BreakStatus	BreakCount
2	8	false	2678	false	4
3	6	false	2678	false	3

Plot the RMSE and ANEES error metrics.

```
subplot(2,2,1)
plot(posRMSE)
title('Position Error')
xlabel('tracker update')
ylabel('RMSE (m)')
```

```
subplot(2,2,2)
plot(velRMSE)
title('Velocity Error')
xlabel('tracker update')
ylabel('RMSE (m/s)')
```

```
subplot(2,2,3)
plot(posANEES)
title('Position Error')
xlabel('tracker update')
ylabel('ANEES')
```

```
subplot(2,2,4)
plot(velANEES)
title('Velocity Error')
xlabel('tracker update')
ylabel('ANEES')
```

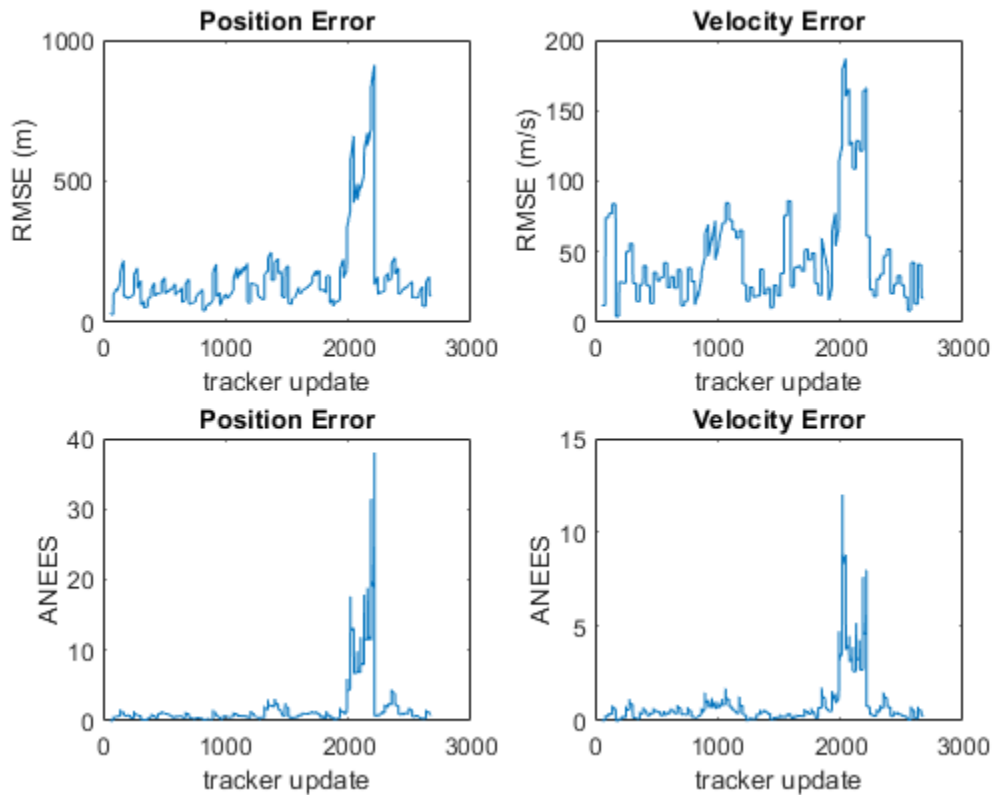

Show the current error metrics for each individual recorded track.

```
currentTrackMetrics(tem)
```

```
ans=2x5 table
```

TrackID	posRMS	velRMS	posANEES	velANEES
6	44.712	20.988	0.05974	0.31325
8	129.26	12.739	1.6745	0.2453

Show the current error metrics for each individual recorded truth object.

```
currentTruthMetrics(tem)
```

```
ans=2x5 table
```

TruthID	posRMS	velRMS	posANEES	velANEES
2	129.26	12.739	1.6745	0.2453
3	44.712	20.988	0.05974	0.31325

Show the cumulative error metrics for each individual recorded track.

```
cumulativeTrackMetrics(tem)
```

ans=4x5 table

TrackID	posRMS	velRMS	posANEES	velANEES
1	117.69	43.951	0.58338	0.44127
2	129.7	42.8	0.81094	0.42509
6	371.35	87.083	4.5208	1.6952
8	130.45	53.914	1.0448	0.44813

Show the cumulative error metrics for each individual recorded truth object.

cumulativeTruthMetrics(tem)

ans=2x5 table

TruthID	posRMS	velRMS	posANEES	velANEES
2	258.21	65.078	2.2514	0.93359
3	134.41	48.253	0.96314	0.49183

See Also

Objects

fusionRadarSensor | trackAssignmentMetrics | trackOSPAMetric | trackerGNN |
trackerJPDA | trackerPHD | trackerTOMHT

Introduced in R2018b

cumulativeTrackMetrics

Cumulative metrics for recent tracks

Syntax

```
metricsTable = cumulativeTrackMetrics(errorMetrics)
```

Description

`metricsTable = cumulativeTrackMetrics(errorMetrics)` returns a table of cumulative metrics, `metricsTable`, for every track identifier provided in the most recent update.

Examples

Assignment and Error Metrics for Two Tracked Targets

Examine the assignments and errors for a system tracking two targets.

First, load the stored track data.

```
load trackmetricex tracklog truthlog
```

Create objects to analyze assignment and error metrics.

```
tam = trackAssignmentMetrics;
tem = trackErrorMetrics;
```

Create the output variables.

```
posRMSE = zeros(numel(tracklog),1);
velRMSE = zeros(numel(tracklog),1);
posANEES = zeros(numel(tracklog),1);
velANEES = zeros(numel(tracklog),1);
```

Loop over all tracks to:

- Extract the tracks and ground truth at the i th tracker update.
- Analyze and retrieve the current track-to-truth assignment.
- Analyze instantaneous error metrics over all tracks and truths.

```
for i=1:numel(tracklog)
    tracks = tracklog{i};
    truths = truthlog{i};
    [trackAM,truthAM] = tam(tracks, truths);
    [trackIDs,truthIDs] = currentAssignment(tam);
    [posRMSE(i),velRMSE(i),posANEES(i),velANEES(i)] = ...
        tem(tracks,trackIDs,truths,truthIDs);
end
```

Show the track metrics table.

```
trackMetricsTable(tam)
```

```
ans=4x15 table
```

TrackID	AssignedTruthID	Surviving	TotalLength	DeletionStatus	DeletionLength
1	NaN	false	1120	false	0
2	NaN	false	1736	false	0
6	3	true	1138	false	0
8	2	true	662	false	0

Show the truth metrics table.

```
truthMetricsTable(tam)
```

```
ans=2x10 table
```

TruthID	AssociatedTrackID	DeletionStatus	TotalLength	BreakStatus	BreakCount
2	8	false	2678	false	4
3	6	false	2678	false	3

Plot the RMSE and ANEES error metrics.

```
subplot(2,2,1)
plot(posRMSE)
title('Position Error')
xlabel('tracker update')
ylabel('RMSE (m)')

subplot(2,2,2)
plot(velRMSE)
title('Velocity Error')
xlabel('tracker update')
ylabel('RMSE (m/s)')

subplot(2,2,3)
plot(posANEES)
title('Position Error')
xlabel('tracker update')
ylabel('ANEES')

subplot(2,2,4)
plot(velANEES)
title('Velocity Error')
xlabel('tracker update')
ylabel('ANEES')
```

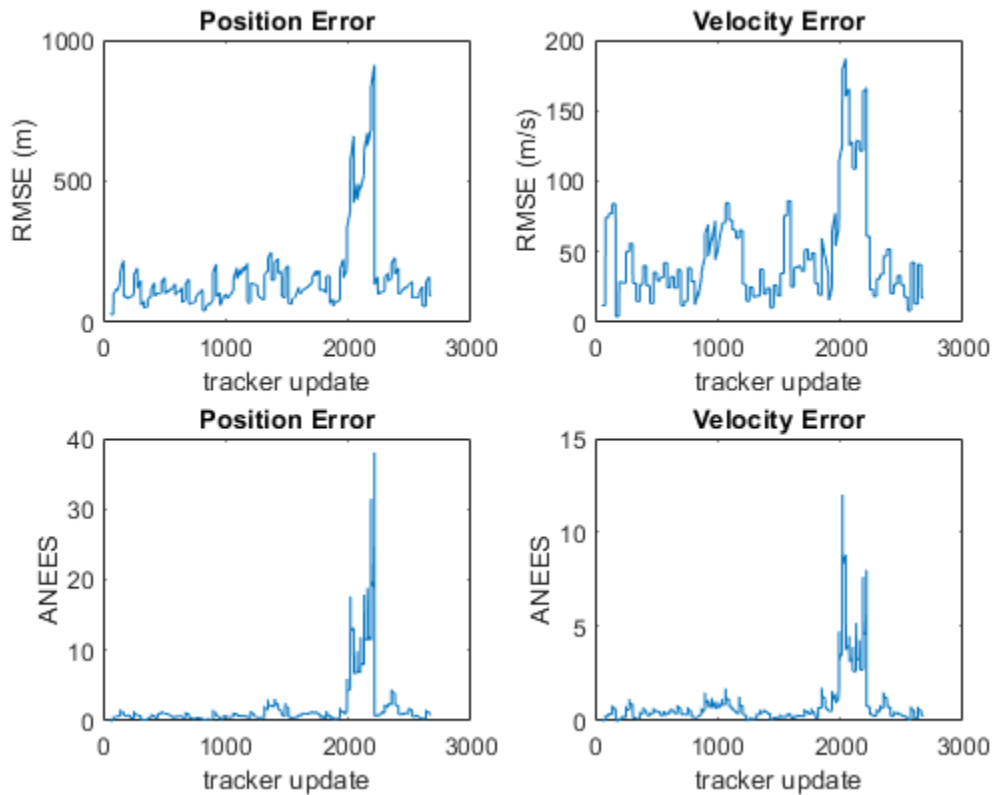
Show the current error metrics for each individual recorded track.

```
currentTrackMetrics(tem)
```

```
ans=2x5 table
```

TrackID	posRMS	velRMS	posANEES	velANEES
6	44.712	20.988	0.05974	0.31325
8	129.26	12.739	1.6745	0.2453

Show the current error metrics for each individual recorded truth object.

```
currentTruthMetrics(tem)
```

```
ans=2x5 table
```

TruthID	posRMS	velRMS	posANEES	velANEES
2	129.26	12.739	1.6745	0.2453
3	44.712	20.988	0.05974	0.31325

Show the cumulative error metrics for each individual recorded track.

```
cumulativeTrackMetrics(tem)
```

```
ans=4x5 table
  TrackID    posRMS    velRMS    posANEES    velANEES
  -----
      1      117.69    43.951    0.58338    0.44127
      2       129.7     42.8     0.81094    0.42509
      6      371.35    87.083    4.5208     1.6952
      8      130.45    53.914    1.0448     0.44813
```

Show the cumulative error metrics for each individual recorded truth object.

```
cumulativeTruthMetrics(tem)
```

```
ans=2x5 table
  TruthID    posRMS    velRMS    posANEES    velANEES
  -----
      2      258.21    65.078     2.2514     0.93359
      3      134.41    48.253     0.96314    0.49183
```

Input Arguments

errorMetrics — Error metrics object

trackErrorMetrics System object

Error metrics object, specified as a trackErrorMetrics System object.

Output Arguments

metricsTable — Track error metrics

table

Track error metrics, returned as a table.

- When you set the ErrorFunctionFormat property of the input error metrics object to 'built-in', the table columns depend on the setting of the MotionModel property.

Motion Model	Table Columns
'constvel'	posRMSE, velRMSE, posANEES, velANEES
'constacc'	posRMSE, velRMSE, accRMSE, posANEES, velANEES, accANEES
'constturn'	posRMSE, velRMSE, yawRateRMSE, posANEES, velANEES, yawRateANEES

RMSE and ANEES denote root mean squared error and average normalized estimation error squared of a track for the entire tracking scenario time history. For example, the cumulative position RMSE value for a track is defined as:

$$\text{posRMSE} = \sqrt{\frac{1}{N} \sum_{t=1}^N \|\Delta p_t\|^2}$$

where N is the total number of time steps that the track has an associated truth.

$$\Delta p_t = p_{track,t} - p_{truth,t}$$

is the difference between the position of the track at time step t , $p_{track,t}$, and the position of the associated truth at time step t , $p_{truth,t}$. The cumulative RMSE values for other states (`vel`, `pos`, `acc`, and `yawRate`) are defined similarly. The position ANEES value, `posANEES` is defined as:

$$posANEES = \frac{1}{N} \sum_{t=1}^N \Delta p_t^T C_{p,t}^{-1} \Delta p_t$$

where $C_{p,t}$ is the covariance corresponding to the position of the track at time step t . The ANEES values for other states (`vel`, `pos`, `acc`, and `yawRate`) are defined similarly.

- When you set the `ErrorFunctionFormat` property to 'custom', the table contains the arithmetically averaged values of the custom metrics output from the error function.

Introduced in R2018b

cumulativeTruthMetrics

Cumulative metrics for recent truths

Syntax

```
metricsTable = cumulativeTruthMetrics(errorMetrics)
```

Description

`metricsTable = cumulativeTruthMetrics(errorMetrics)` returns a table of cumulative metrics, `metricsTable`, for every truth identifier provided in the most recent update.

Examples

Assignment and Error Metrics for Two Tracked Targets

Examine the assignments and errors for a system tracking two targets.

First, load the stored track data.

```
load trackmetricex tracklog truthlog
```

Create objects to analyze assignment and error metrics.

```
tam = trackAssignmentMetrics;  
tem = trackErrorMetrics;
```

Create the output variables.

```
posRMSE = zeros(numel(tracklog),1);  
velRMSE = zeros(numel(tracklog),1);  
posANEES = zeros(numel(tracklog),1);  
velANEES = zeros(numel(tracklog),1);
```

Loop over all tracks to:

- Extract the tracks and ground truth at the i th tracker update.
- Analyze and retrieve the current track-to-truth assignment.
- Analyze instantaneous error metrics over all tracks and truths.

```
for i=1:numel(tracklog)  
    tracks = tracklog{i};  
    truths = truthlog{i};  
    [trackAM,truthAM] = tam(tracks, truths);  
    [trackIDs,truthIDs] = currentAssignment(tam);  
    [posRMSE(i),velRMSE(i),posANEES(i),velANEES(i)] = ...  
        tem(tracks,trackIDs,truths,truthIDs);  
end
```

Show the track metrics table.

```
trackMetricsTable(tam)
```

```
ans=4x15 table
```

TrackID	AssignedTruthID	Surviving	TotalLength	DeletionStatus	DeletionLength
1	NaN	false	1120	false	0
2	NaN	false	1736	false	0
6	3	true	1138	false	0
8	2	true	662	false	0

Show the truth metrics table.

```
truthMetricsTable(tam)
```

```
ans=2x10 table
```

TruthID	AssociatedTrackID	DeletionStatus	TotalLength	BreakStatus	BreakCount
2	8	false	2678	false	4
3	6	false	2678	false	3

Plot the RMSE and ANEES error metrics.

```
subplot(2,2,1)
plot(posRMSE)
title('Position Error')
xlabel('tracker update')
ylabel('RMSE (m)')
```

```
subplot(2,2,2)
plot(velRMSE)
title('Velocity Error')
xlabel('tracker update')
ylabel('RMSE (m/s)')
```

```
subplot(2,2,3)
plot(posANEES)
title('Position Error')
xlabel('tracker update')
ylabel('ANEES')
```

```
subplot(2,2,4)
plot(velANEES)
title('Velocity Error')
xlabel('tracker update')
ylabel('ANEES')
```

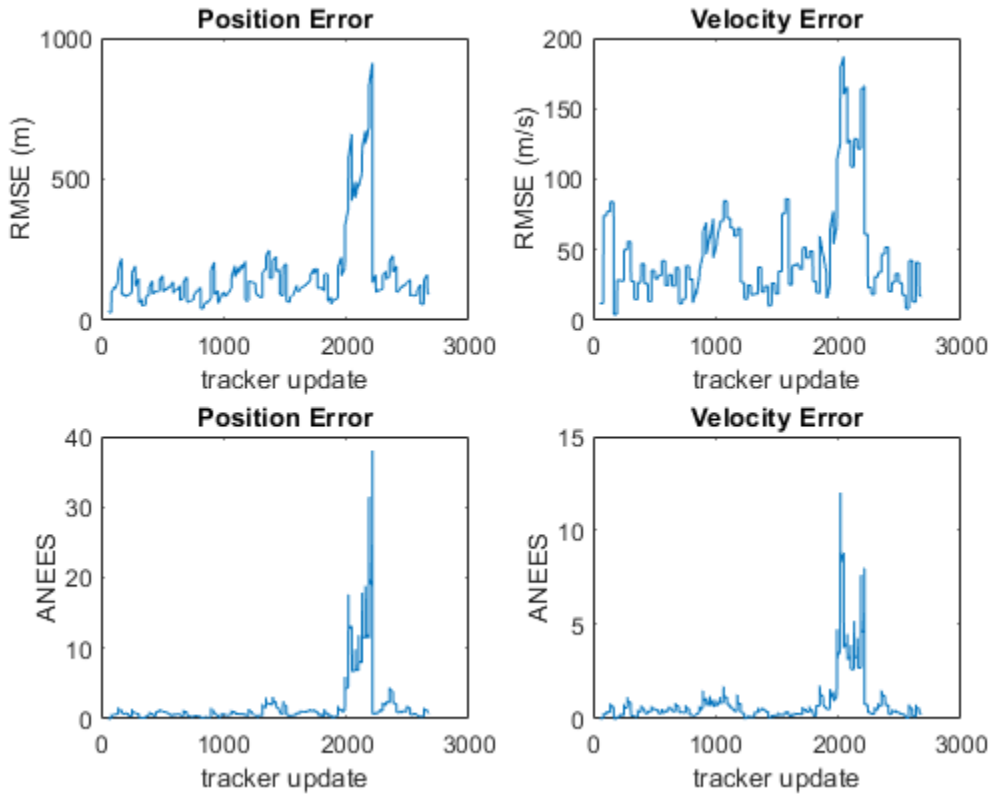

Show the current error metrics for each individual recorded track.

```
currentTrackMetrics(tem)
```

ans=2x5 table

TrackID	posRMS	velRMS	posANEES	velANEES
6	44.712	20.988	0.05974	0.31325
8	129.26	12.739	1.6745	0.2453

Show the current error metrics for each individual recorded truth object.

```
currentTruthMetrics(tem)
```

ans=2x5 table

TruthID	posRMS	velRMS	posANEES	velANEES
2	129.26	12.739	1.6745	0.2453
3	44.712	20.988	0.05974	0.31325

Show the cumulative error metrics for each individual recorded track.

```
cumulativeTrackMetrics(tem)
```

```
ans=4x5 table
  TrackID    posRMS    velRMS    posANEES    velANEES
  -----    -
      1      117.69    43.951    0.58338    0.44127
      2       129.7     42.8     0.81094    0.42509
      6      371.35    87.083    4.5208     1.6952
      8      130.45    53.914    1.0448     0.44813
```

Show the cumulative error metrics for each individual recorded truth object.

```
cumulativeTruthMetrics(tem)
```

```
ans=2x5 table
  TruthID    posRMS    velRMS    posANEES    velANEES
  -----    -
      2      258.21    65.078    2.2514     0.93359
      3      134.41    48.253    0.96314    0.49183
```

Input Arguments

errorMetrics – Error metrics object

trackErrorMetrics System object

Error metrics object, specified as a trackErrorMetrics System object.

Output Arguments

metricsTable – Truth error metrics

table

Truth error metrics, returned as a table.

- When you set the ErrorFunctionFormat property of the input error metrics object to 'built-in', the table columns depend on the setting of the MotionModel property.

Motion Model	Table Columns
'constvel'	posRMSE, velRMSE, posANEES, velANEES
'constacc'	posRMSE, velRMSE, accRMSE, posANEES, velANEES, accANEES
'constturn'	posRMSE, velRMSE, yawRateRMSE, posANEES, velANEES, yawRateANEES

RMSE and ANEES denote root mean squared error and average normalized estimation error squared of a truth trajectory for the entire tracking scenario time history. Since a truth trajectory can associate with multiple tracks at a time step, the calculation of cumulative RMSE and ANEES values is each separated into two steps. For example, in the first step of the position RMSE value calculation, the function first calculates the RMSE value at a given time step t as:

$$S_t = \sum_{k=1}^{K_t} \|\Delta p_{t,k}\|^2$$

where K_t is the number of tracks associated with the truth at time step t , and

$$\Delta p_{t,k} = p_{track,t,k} - p_{truth,t}$$

is the position difference between the position of k th associated track and the position of the truth at time step t . In the second step, the S_t values of all the time steps ($t = 1, 2, \dots, N$) are summed and averaged over the total number of associated tracks (denoted by R) to obtain the cumulative position RMSE value as:

$$\text{posRMSE} = \sqrt{\frac{1}{\sum_{t=1}^N K_t} \sum_{t=1}^N \sum_{k=1}^{K_t} \|\Delta p_{t,k}\|^2}$$

where the total number of associated tracks, R , is given by

$$R = \sum_{t=1}^N K_t.$$

The cumulative RMSE values for other states (`vel`, `pos`, `acc`, and `yawRate`) are defined similarly.

The calculation of the cumulative position ANEES value, `posANEES`, for a truth trajectory can also be separated into two steps. In the first step, the function calculates the ANEES value at a given time step t as:

$$Q_t = \sum_{k=1}^{K_t} \Delta p_{t,k}^T C_{p,t,k}^{-1} \Delta p_{t,k}$$

where $C_{p,t,k}$ is the covariance corresponding to the position of the k th associated track at time step t . In the second step, the Q_t values for all the time steps ($t = 1, 2, \dots, N$) are summed and averaged over the total number of associated tracks (denoted by R) to obtain the cumulative position ANEES value as:

$$\text{posANEES} = \frac{1}{\sum_{t=1}^N K_t} \sum_{t=1}^N \sum_{k=1}^{K_t} \Delta p_{t,k}^T C_{p,t,k}^{-1} \Delta p_{t,k}$$

The cumulative ANEES values for other states (`vel`, `pos`, `acc`, and `yawRate`) are defined similarly.

- When you set the `ErrorFunctionFormat` property to 'custom', the table contains the arithmetically averaged values of the custom metrics output from the error function.

Introduced in R2018b

currentTrackMetrics

Metrics for recent tracks

Syntax

```
metricsTable = currentTrackMetrics(errorMetrics)
```

Description

`metricsTable = currentTrackMetrics(errorMetrics)` returns a table of metrics, `metricsTable`, for every track identifier provided in the most recent update.

Examples

Assignment and Error Metrics for Two Tracked Targets

Examine the assignments and errors for a system tracking two targets.

First, load the stored track data.

```
load trackmetricex tracklog truthlog
```

Create objects to analyze assignment and error metrics.

```
tam = trackAssignmentMetrics;
tem = trackErrorMetrics;
```

Create the output variables.

```
posRMSE = zeros(numel(tracklog),1);
velRMSE = zeros(numel(tracklog),1);
posANEES = zeros(numel(tracklog),1);
velANEES = zeros(numel(tracklog),1);
```

Loop over all tracks to:

- Extract the tracks and ground truth at the i th tracker update.
- Analyze and retrieve the current track-to-truth assignment.
- Analyze instantaneous error metrics over all tracks and truths.

```
for i=1:numel(tracklog)
    tracks = tracklog{i};
    truths = truthlog{i};
    [trackAM,truthAM] = tam(tracks, truths);
    [trackIDs,truthIDs] = currentAssignment(tam);
    [posRMSE(i),velRMSE(i),posANEES(i),velANEES(i)] = ...
        tem(tracks,trackIDs,truths,truthIDs);
end
```

Show the track metrics table.

```
trackMetricsTable(tam)
```

```
ans=4x15 table
```

TrackID	AssignedTruthID	Surviving	TotalLength	DeletionStatus	DeletionLength
1	NaN	false	1120	false	0
2	NaN	false	1736	false	0
6	3	true	1138	false	0
8	2	true	662	false	0

Show the truth metrics table.

```
truthMetricsTable(tam)
```

```
ans=2x10 table
```

TruthID	AssociatedTrackID	DeletionStatus	TotalLength	BreakStatus	BreakCount
2	8	false	2678	false	4
3	6	false	2678	false	3

Plot the RMSE and ANEES error metrics.

```
subplot(2,2,1)
plot(posRMSE)
title('Position Error')
xlabel('tracker update')
ylabel('RMSE (m)')

subplot(2,2,2)
plot(velRMSE)
title('Velocity Error')
xlabel('tracker update')
ylabel('RMSE (m/s)')

subplot(2,2,3)
plot(posANEES)
title('Position Error')
xlabel('tracker update')
ylabel('ANEES')

subplot(2,2,4)
plot(velANEES)
title('Velocity Error')
xlabel('tracker update')
ylabel('ANEES')
```

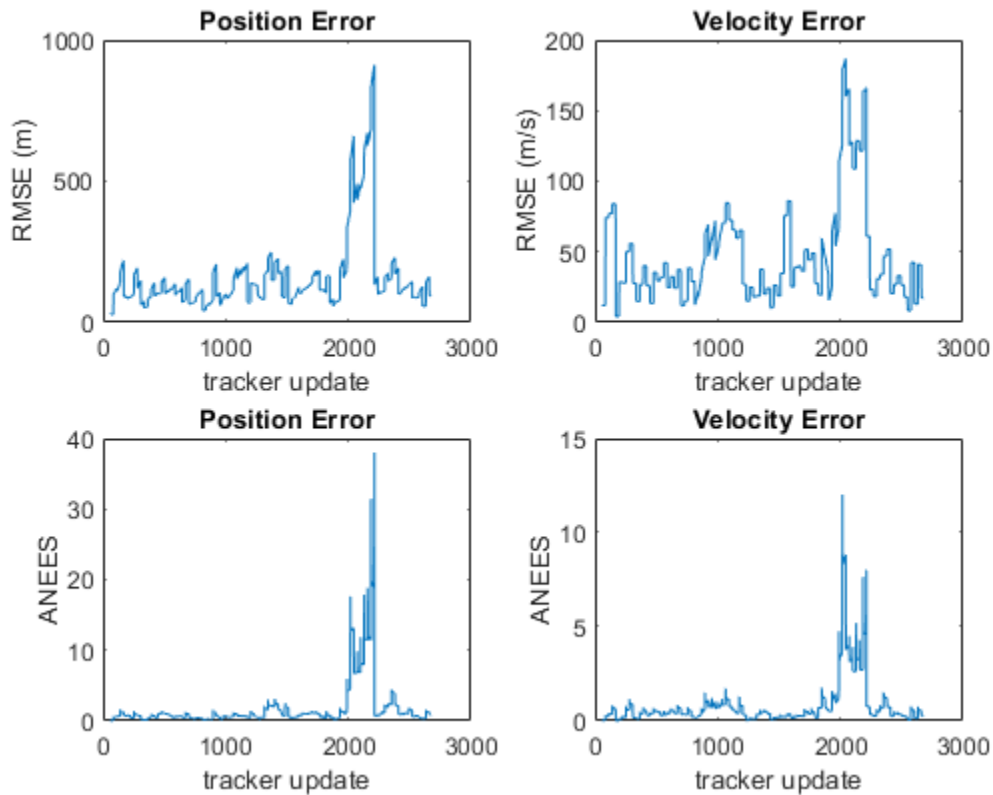

Show the current error metrics for each individual recorded track.

```
currentTrackMetrics(tem)
```

```
ans=2x5 table
```

TrackID	posRMS	velRMS	posANEES	velANEES
6	44.712	20.988	0.05974	0.31325
8	129.26	12.739	1.6745	0.2453

Show the current error metrics for each individual recorded truth object.

```
currentTruthMetrics(tem)
```

```
ans=2x5 table
```

TruthID	posRMS	velRMS	posANEES	velANEES
2	129.26	12.739	1.6745	0.2453
3	44.712	20.988	0.05974	0.31325

Show the cumulative error metrics for each individual recorded track.

```
cumulativeTrackMetrics(tem)
```

ans=4x5 table

TrackID	posRMS	velRMS	posANEES	velANEES
1	117.69	43.951	0.58338	0.44127
2	129.7	42.8	0.81094	0.42509
6	371.35	87.083	4.5208	1.6952
8	130.45	53.914	1.0448	0.44813

Show the cumulative error metrics for each individual recorded truth object.

cumulativeTruthMetrics(tem)

ans=2x5 table

TruthID	posRMS	velRMS	posANEES	velANEES
2	258.21	65.078	2.2514	0.93359
3	134.41	48.253	0.96314	0.49183

Input Arguments

errorMetrics — Error metrics object

trackErrorMetrics System object

Error metrics object, specified as a trackErrorMetrics System object.

Output Arguments

metricsTable — Track error metrics

table

Track error metrics, returned as a table:

- When you set the ErrorFunctionFormat property of the input error metrics object to 'built-in', the table columns depend on the setting of the MotionModel property.

Motion Model	Table Columns
'constvel'	posRMSE, velRMSE, posANEES, velANEES
'constacc'	posRMSE, velRMSE, accRMSE, posANEES, velANEES, accANEES
'constturn'	posRMSE, velRMSE, yawRateRMSE, posANEES, velANEES, yawRateANEES

RMSE and ANEES denote root mean squared error and average normalized estimation error squared of a track at the current time step. For example, the position RMSE and ANEES values for a track are defined respectively as:

$$posRMSE = \|\Delta p_i\| = \|p_{track,i} - p_{truth,i}\|$$

$$posANEES = \Delta p_i^T C_i^{-1} \Delta p_i$$

where $p_{track, i}$ is the position of track i , $p_{truth, i}$ is the position of the truth associated to track i , and C_i is the position covariance of track i at the current time step. Note that the RMSE and ANEES values are only calculated for one time step using the `currentTrackMetrics`. The RMSE and ANEES values for other states (`vel`, `pos`, `acc`, and `yawRate`) are defined similarly.

- When you set the `ErrorFunctionFormat` property to 'custom', the table contains the arithmetically averaged values of the custom metrics output from the error function.

Introduced in R2018b

currentTruthMetrics

Metrics for recent truths

Syntax

```
metricsTable = currentTruthMetrics(errorMetrics)
```

Description

`metricsTable = currentTruthMetrics(errorMetrics)` returns a table of metrics, `metricsTable`, for every truth identifier provided in the most recent update.

Examples

Assignment and Error Metrics for Two Tracked Targets

Examine the assignments and errors for a system tracking two targets.

First, load the stored track data.

```
load trackmetricex tracklog truthlog
```

Create objects to analyze assignment and error metrics.

```
tam = trackAssignmentMetrics;  
tem = trackErrorMetrics;
```

Create the output variables.

```
posRMSE = zeros(numel(tracklog),1);  
velRMSE = zeros(numel(tracklog),1);  
posANEES = zeros(numel(tracklog),1);  
velANEES = zeros(numel(tracklog),1);
```

Loop over all tracks to:

- Extract the tracks and ground truth at the i th tracker update.
- Analyze and retrieve the current track-to-truth assignment.
- Analyze instantaneous error metrics over all tracks and truths.

```
for i=1:numel(tracklog)  
    tracks = tracklog{i};  
    truths = truthlog{i};  
    [trackAM,truthAM] = tam(tracks, truths);  
    [trackIDs,truthIDs] = currentAssignment(tam);  
    [posRMSE(i),velRMSE(i),posANEES(i),velANEES(i)] = ...  
        tem(tracks,trackIDs,truths,truthIDs);  
end
```

Show the track metrics table.

```
trackMetricsTable(tam)
```

```
ans=4x15 table
```

TrackID	AssignedTruthID	Surviving	TotalLength	DeletionStatus	DeletionLength
1	NaN	false	1120	false	0
2	NaN	false	1736	false	0
6	3	true	1138	false	0
8	2	true	662	false	0

Show the truth metrics table.

```
truthMetricsTable(tam)
```

```
ans=2x10 table
```

TruthID	AssociatedTrackID	DeletionStatus	TotalLength	BreakStatus	BreakCount
2	8	false	2678	false	4
3	6	false	2678	false	3

Plot the RMSE and ANEES error metrics.

```
subplot(2,2,1)
plot(posRMSE)
title('Position Error')
xlabel('tracker update')
ylabel('RMSE (m)')
```

```
subplot(2,2,2)
plot(velRMSE)
title('Velocity Error')
xlabel('tracker update')
ylabel('RMSE (m/s)')
```

```
subplot(2,2,3)
plot(posANEES)
title('Position Error')
xlabel('tracker update')
ylabel('ANEES')
```

```
subplot(2,2,4)
plot(velANEES)
title('Velocity Error')
xlabel('tracker update')
ylabel('ANEES')
```

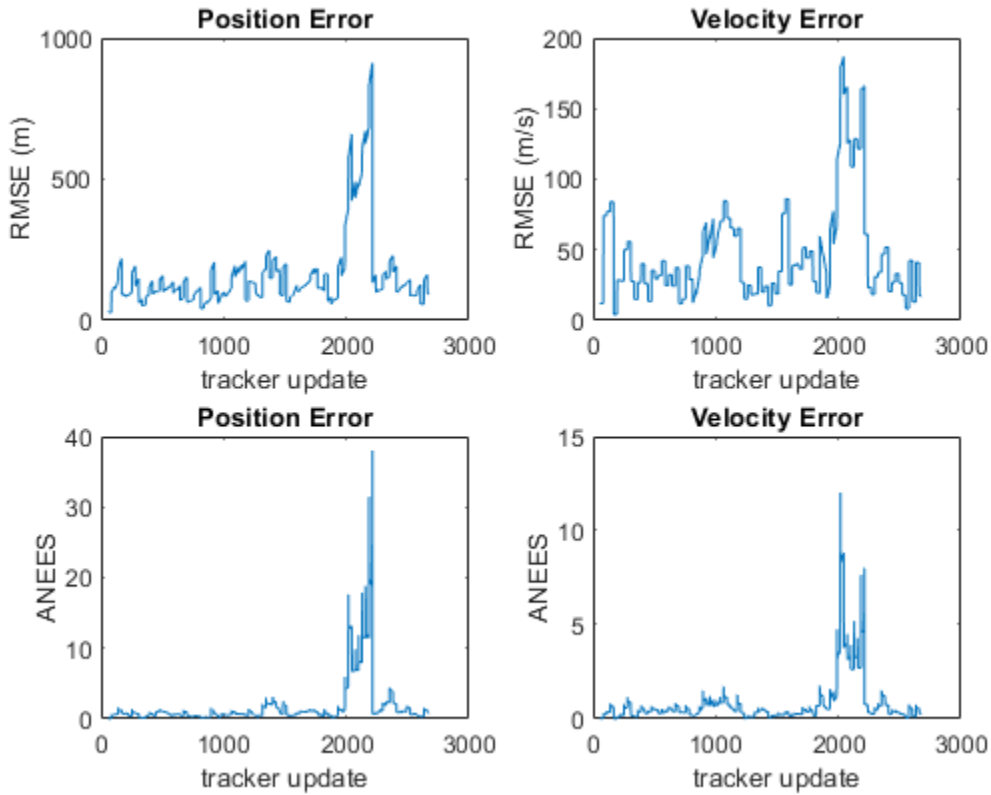

Show the current error metrics for each individual recorded track.

```
currentTrackMetrics(tem)
```

ans=2x5 table

TrackID	posRMS	velRMS	posANEES	velANEES
6	44.712	20.988	0.05974	0.31325
8	129.26	12.739	1.6745	0.2453

Show the current error metrics for each individual recorded truth object.

```
currentTruthMetrics(tem)
```

ans=2x5 table

TruthID	posRMS	velRMS	posANEES	velANEES
2	129.26	12.739	1.6745	0.2453
3	44.712	20.988	0.05974	0.31325

Show the cumulative error metrics for each individual recorded track.

```
cumulativeTrackMetrics(tem)
```



```
ans=4x5 table
  TrackID    posRMS    velRMS    posANEES    velANEES
  -----    -
      1      117.69    43.951    0.58338    0.44127
      2       129.7     42.8     0.81094    0.42509
      6      371.35    87.083    4.5208     1.6952
      8      130.45    53.914    1.0448     0.44813
```

Show the cumulative error metrics for each individual recorded truth object.

```
cumulativeTruthMetrics(tem)
```

```
ans=2x5 table
  TruthID    posRMS    velRMS    posANEES    velANEES
  -----    -
      2      258.21    65.078    2.2514     0.93359
      3      134.41    48.253    0.96314    0.49183
```

Input Arguments

errorMetrics — Error metrics object

trackErrorMetrics System object

Error metrics object, specified as a trackErrorMetrics System object.

Output Arguments

metricsTable — Truth error metrics

table

Truth error metrics, returned as a table.

- When you set the ErrorFunctionFormat property of the input error metrics object to 'built-in', the table columns depend on the setting of the MotionModel property.

Motion model	Table Columns
'constvel'	posRMSE, velRMSE, posANEES, velANEES.
'constacc'	posRMSE, velRMSE, accRMSE, posANEES, velANEES, accANEES
'constturn'	posRMSE, velRMSE, yawRateRMSE, posANEES, velANEES, yawRateANEES

RMSE and ANEES denote root mean squared error and average normalized estimation error squared between a truth trajectory and its associated tracks at the current time step. Note that a truth trajectory can associate with multiple tracks. For example, the position RMSE and ANEES values for a truth are defined respectively as:

$$\begin{aligned} \text{posRMSE} &= \sqrt{\frac{1}{K} \sum_{k=1}^K \|\Delta p_k\|} \\ \text{posANEES} &= \frac{1}{K} \Delta p_k^T C_k^{-1} \Delta p_k \end{aligned}$$

where K is the total number of tracks associated with the truth, C_k is the position covariance of the k th track at the current time step, and

$$\Delta p_k = p_{\text{track},k} - p_{\text{truth}}$$

is the position error between the k th associated track and the truth. The RMSE and ANEES values for other states (`vel`, `pos`, `acc`, and `yawRate`) are defined similarly.

- When you set the `ErrorFunctionFormat` property to 'custom', the table contains the arithmetically averaged values of the custom metrics output from the error function.

Introduced in R2018b

trackFuser

Single-hypothesis track-to-track fuser

Description

The `trackFuser` System object fuses tracks generated by tracking sensors or trackers and architect decentralized tracking systems. `trackFuser` uses the global nearest neighbor (GNN) algorithm to maintain a single hypothesis about the objects it tracks. The input tracks are called source or local tracks, and the output tracks are called central tracks.

To fuse tracks using this object:

- 1 Create the `trackFuser` object and set its properties.
- 2 Call the object with arguments, as if it were a function.

To learn more about how System objects work, see [What Are System Objects?](#).

Creation

Syntax

```
fuser = trackFuser
fuser = trackFuser(Name,Value)
```

Description

`fuser = trackFuser` creates a track-to-track fuser that uses the global nearest neighbor (GNN) algorithm to maintain a single hypothesis about the objects it tracks.

`fuser = trackFuser(Name,Value)` sets properties for the fuser using one or more name-value pairs. Unspecified properties have default values. Enclose each property name in single quotes.

Properties

Unless otherwise indicated, properties are *nontunable*, which means you cannot change their values after calling the object. Objects lock when you call them, and the `release` function unlocks them.

If a property is *tunable*, you can change its value at any time.

For more information on changing property values, see [System Design in MATLAB Using System Objects](#).

FuserIndex — Unique index for track fuser

1 (default) | positive integer

Unique index for the fuser, specified as a positive integer. Use this property to distinguish different fusers in a multiple-fuser environment.

Example: 2

MaxNumSources — Maximum number of source configurations

20 (default) | positive integer

Maximum number of source configurations that the fuser can maintain, specified as a positive integer.

Example: 200

SourceConfigurations — Configurations of source systems

cell array of fuserSourceConfiguration objects

Configurations of source systems, specified as a cell array of fuserSourceConfiguration objects. The default value is a 1-by- N cell array of fuserSourceConfiguration objects, where N is the value of the MaxNumSources property. You can specify this property during creation as a Name-Value pair or specify it after creation.

Data Types: object

Assignment — Assignment algorithm

'MatchPairs' (default) | 'Munkres' | 'Jonker-Volgenant' | 'Auction' | 'Custom'

Assignment algorithm, specified as 'MatchPairs', 'Munkres', 'Jonker-Volgenant', 'Auction', or 'Custom'. Munkres is the only assignment algorithm that guarantees an optimal solution, but it is also the slowest, especially for large numbers of detections and tracks. The other algorithms do not guarantee an optimal solution but can be faster for problems with 20 or more tracks and detections. Use 'Custom' to define your own assignment function and specify its name in the CustomAssignmentFcn property.

Data Types: char

CustomAssignmentFcn — Custom assignment function

function handle

Custom assignment function, specified as a function handle. An assignment function must have the following syntax:

```
[assignments,unassignedCentral,unassignedLocal] = f(cost,costNonAssignment)
```

For an example of assignment function and a description of its arguments, see assignmunkres.

Dependencies

To enable this property, set the Assignment property to 'Custom'.

Data Types: function handle | string | char

AssignmentThreshold — Track-to-track assignment threshold

30*[1 Inf] (default) | positive scalar | 1-by-2 vector of positive values

Track-to-track assignment threshold, specified as a positive scalar or a 1-by-2 vector of $[C_1, C_2]$, where $C_1 \leq C_2$. If specified as a scalar, the specified value, *val*, is expanded to $[val, Inf]$.

Initially, the fuser executes a coarse estimation for the normalized distance between all the local and central tracks. The fuser only calculates the accurate normalized distance for the local and central combinations whose coarse normalized distance is less than C_2 . Also, the fuser can only assign a local track to a central track if their accurate normalized distance is less than C_1 . See the distance

function used with tracking filters (`trackingCKF` and `trackingEKF` for example) for an explanation of the distance calculation.

Tips:

- Increase the value of C_2 if there are combinations of local and central tracks that should be calculated for assignment but are not. Decrease it if the calculation takes too much time.
- Increase the value of C_1 if there are local tracks that should be assigned to central tracks but are not. Decrease it if there are local tracks that are assigned to central tracks they should not be assigned to (too far away).

StateTransitionFcn — State transition function

'constvel' (default) | function handle

State transition function, specified as a function handle. This function calculates the state at time step k based on the state at time step $k-1$.

- If `HasAdditiveProcessNoise` is `true`, the function must use the following syntax:

$$x(k) = f(x(k-1), dt)$$

where:

- $x(k)$ — The (estimated) state at time k , specified as a vector or a matrix. If specified as a matrix, then each column of the matrix represents one state vector.
 - dt — The time step for prediction.
- If `HasAdditiveProcessNoise` is `false`, the function must use this syntax:

$$x(k) = f(x(k-1), w(k-1), dt)$$

where:

- $x(k)$ — The (estimated) state at time k , specified as a vector or a matrix. If specified as a matrix, then each column of the matrix represents one state vector.
- $w(k)$ — The process noise at time k .
- dt — The time step for prediction.

Example: `@constacc`

Data Types: `function_handle` | `char` | `string`

StateTransitionJacobianFcn — Jacobian of state transition function

' ' (default) | function handle

Jacobian of the state transition function, specified as a function handle. If not specified, the Jacobian is numerically computed, which may increase processing time and numerical inaccuracy. If specified, the function must support one of these two syntaxes:

- If `HasAdditiveProcessNoise` is `true`, the function must use this syntax:

$$Jx(k) = \text{statejacobianfcn}(x(k), dt)$$

where:

- $x(k)$ — The (estimated) state at time k , specified as an M -by-1 vector of real values.

- `dt` — The time step for prediction.
- `Jx(k)` — The Jacobian of the state transition function with respect to the state, df/dx , evaluated at $x(k)$. The Jacobian is returned as an M -by- M matrix.
- If `HasAdditiveProcessNoise` is `false`, the function must use this syntax:

```
[Jx(k),Jw(k)] = statejacobianfcn(x(k),w(k),dt)
```

where:

- $x(k)$ — The (estimated) state at time k , specified as an M -by-1 vector of real values.
- $w(k)$ — The process noise at time k , specified as a W -by-1 vector of real values.
- `dt` — The time step for prediction.
- `Jx(k)` — The Jacobian of the state transition function with respect to the state, df/dx , evaluated at $x(k)$. The Jacobian is returned as an M -by- M matrix.
- `Jw(k)` — The Jacobian of the state transition function with respect to the process noise, df/dw , evaluated at $x(k)$ and $w(k)$. The Jacobian is returned as an M -by- W matrix.

Example: `@constaccjac`

Data Types: `function_handle` | `char` | `string`

ProcessNoise — Process noise covariance

`eye(3)` (default) | positive real scalar | positive definite matrix

Process noise covariance, specified as a positive real scalar or a positive definite matrix.

- When `HasAdditiveProcessNoise` is `true`, specify the process noise covariance as a positive real scalar or a positive definite M -by- M matrix. M is the dimension of the state vector. When specified as a scalar, the matrix is a multiple of the M -by- M identity matrix.
- When `HasAdditiveProcessNoise` is `false`, specify the process noise covariance as a W -by- W matrix. W is the dimension of the process noise vector.

Example: `[1.0 0.05; 0.05 2]`

Data Types: `single` | `double`

HasAdditiveProcessNoise — Model additive process noise

`false` (default) | `true`

Option to model process noise as additive, specified as `true` or `false`. When this property is `true`, process noise is added to the state vector. Otherwise, noise is incorporated into the state transition function.

StateParameters — Parameters of track state reference frame

`struct()` (default) | structure | structure array

Parameters of the track state reference frame, specified as a structure or a structure array. The fuser passes its `StateParameters` property values to the `StateParameters` property of the generated tracks. You can use these parameters to define the reference frame in which the track is reported or other desirable attributes of the generated tracks.

For example, you can use the following structure to define a rectangular reference frame whose origin position is at `[10 10 0]` meters and whose origin velocity is `[2 -2 0]` meters per second with respect to the scenario frame.

Field Name	Value
Frame	"Rectangular"
Position	[10 10 0]
Velocity	[2 -2 0]

Tunable: Yes

Data Types: struct

ConfirmationThreshold — Threshold for central track confirmation

[2 3] (default) | positive integer | 1-by-2 vector of positive integers

Threshold for central track confirmation, specified as a positive integer M , or a 1-by-2 vector of positive integers $[M N]$ with $M \leq N$. A central track is confirmed if it is assigned to local tracks at least M times in the last N updates. If specified a positive integer M , the confirmation threshold is expanded to $[M,M]$.

Data Types: single | double

DeletionThreshold — Threshold for central track deletion

[5 5] (default) | positive integer | 1-by-2 vector of positive integers

Threshold for central track deletion, specified as a positive integer P , or a 1-by-2 vector of positive integers $[P R]$ with $P \leq R$. A central track is deleted if the track is not assigned to local tracks at least P times in the last R updates. If specified a positive integer P , the confirmation threshold is expanded to $[P,P]$.

Example: [5 6]

Data Types: single | double

FuseConfirmedOnly — Fuse only confirmed local tracks

true (default) | false

Fuse only confirmed local tracks, specified as false or true. Set this property to false if you want to fuse all local tracks regardless of their confirmation status.

Data Types: logical

FuseCoasted — Fuse coasted local tracks

false (default) | true

Fuse coasted local tracks, specified as true or false. Set this property to true if you want to fuse coasted local tracks (IsCoasted field or property of the localTracks input is true). Set it to false if you want to only fuse local tracks that are not coasted.

Example: true

Data Types: logical

StateFusion — State fusion algorithm

'Cross' (default) | 'Intersection' | 'Custom'

State fusion algorithm, specified as:

- 'Cross' — Uses the cross-covariance fusion algorithm

- 'Intersection' — Uses the covariance intersection fusion algorithm
- 'Custom' — Allows you to specify a customized fusion function

Use the `StateFusionParameters` property to specify additional parameters used by the state fusion algorithm.

Data Types: char

CustomStateFusionFcn — Custom state fusion function

' ' (default) | function handle

Custom state fusion function, specified as a function handle. The state fusion function must support one of the following syntaxes:

```
[fusedState, fusedCov] = f(trackState, trackCov)
[fusedState, fusedCov] = f(trackState, trackCov, fuseParams)
```

where:

- `trackState` is specified as an N -by- M matrix. N is the dimension of the track state, and M is the number of tracks.
- `trackCov` is specified as an N -by- N - M matrix. N is the dimension of the track state, and M is the number of tracks.
- `fuseParams` is optional parameters defined in the `StateFusionParameters` property.
- `fusedState` is returned as an N -by-1 vector.
- `fusedCov` is returned as an N -by- N matrix.

Dependencies

To enable this property, set the `StateFusion` property to 'Custom'.

Data Types: function_handle | char | string

StateFusionParameters — Parameters for state fusion function

[] (default)

Parameters for state fusion function. Depending on the choice of `StateFusion` algorithm, you can specify `StateFusionParameters` as:

- If `StateFusion` is 'Cross', specify it as a scalar in (0,1). See `fusexcov` for more details.
- If `StateFusion` is 'Intersection', specify it as 'det' or 'trace'. See `fusecovint` for more details.
- If `StateFusion` is 'Custom', you can specify these parameters in any variable type, as long as they match the setup of the optional `fuseParams` input of the custom state fusion function specified in the `CustomStateFusionFcn` property.

By default, the property is empty.

NumCentralTracks — Number of central-level tracks

nonnegative integer

This property is read-only.

Number of central tracks currently maintained by the fuser, returned as a nonnegative integer.

Data Types: double

NumConfirmedCentralTracks — Number of confirmed central tracks

nonnegative integer

This property is read-only.

Number of confirmed central tracks currently maintained by the fuser, returned as a nonnegative integer.

Data Types: double

Usage

Syntax

```
confirmedTracks = fuser(localTracks,tFusion)
[confirmedTracks,tentativeTracks,allTracks,analysisInformation] = fuser(
localTracks,tFusion)
```

Description

`confirmedTracks = fuser(localTracks,tFusion)` returns a list of confirmed tracks from a list of local tracks. Confirmed tracks are predicted to the update time, `tFusion`.

`[confirmedTracks,tentativeTracks,allTracks,analysisInformation] = fuser(localTracks,tFusion)` also returns a list of tentative tracks, a list of all tracks, and the analysis information.

Input Arguments

localTracks — Local tracks

array of `objectTrack` objects | array of structures

Local tracks, specified as an array of `objectTrack` objects, or an array of structures with field names that match the property names of an `objectTrack` object. Local tracks are tracks generated from trackers in a source track system.

Data Types: `object` | `struct`

tFusion — Update time

scalar

Update time, specified as a scalar. The fuser predicts all central tracks to this time. Units are in seconds.

Data Types: `single` | `double`

Output Arguments

confirmedTracks — Confirmed tracks

array of `objectTrack` objects | array of structures

Confirmed tracks, returned as an array of `objectTrack` objects in MATLAB, and returned as an array of structures in code generation. In code generation, the field names of the returned structure are same with the property names of `objectTrack`.

A track is confirmed if it satisfies the confirmation threshold specified in the `ConfirmationThreshold` property. In that case, the `IsConfirmed` property of the object or field of the structure is `true`.

Data Types: `struct` | `object`

tentativeTracks – Tentative tracks

array of `objectTrack` objects | array of structures

Tentative tracks, returned as an array of `objectTrack` objects in MATLAB, and returned as an array of structures in code generation. In code generation, the field names of the returned structure are same with the property names of `objectTrack`.

A track is tentative if it does not satisfy the confirmation threshold specified in the `ConfirmationThreshold` property. In that case, the `IsConfirmed` property of the object or field of the structure is `false`.

Data Types: `struct` | `object`

allTracks – All tracks

array of `objectTrack` objects | array of structures

All tracks, returned as an array of `objectTrack` objects in MATLAB, and returned as an array of structures in code generation. In code generation, the field names of the returned structure are same with the property names of `objectTrack`. All tracks consists of confirmed and tentative tracks.

Data Types: `struct` | `object`

analysisInformation – Additional information for analyzing track updates

structure

Additional information for analyzing track updates, returned as a structure. The fields of this structure are:

Field	Description
<code>TrackIDsAtStepBeginning</code>	Track IDs when the step began
<code>CostMatrix</code>	Cost of assignment matrix
<code>Assignments</code>	Assignments returned from the assignment function
<code>UnassignedCentralTracks</code>	IDs of unassigned central tracks
<code>UnassignedLocalTracks</code>	IDs of unassigned local tracks
<code>NonInitializingLocalTracks</code>	IDs of local tracks that were unassigned but were not used to initialize a central track
<code>InitiatedCentralTrackIDs</code>	IDs of central tracks initiated during the step
<code>UpdatedCentralTrackIDs</code>	IDs of central tracks updated during the step
<code>DeletedTrackIDs</code>	IDs of central tracks deleted during the step
<code>TrackIDsAtStepEnd</code>	IDs of central tracks when the step ended

Data Types: `struct`

Object Functions

To use an object function, specify the System object as the first input argument. For example, to release system resources of a System object named `obj`, use this syntax:

```
release(obj)
```

Specific to trackFuser

<code>predictTrackToTime</code>	Predict track state
<code>initializeTrack</code>	Initialize new track
<code>deleteTrack</code>	Delete existing track
<code>sourceIndices</code>	Fuser source indices

Common to All System Objects

<code>step</code>	Run System object algorithm
<code>release</code>	Release resources and allow changes to System object property values and input characteristics
<code>clone</code>	Create duplicate System object
<code>isLocked</code>	Determine if System object is in use
<code>reset</code>	Reset internal states of System object

Examples

Fuse Tracks from Two Sources Using trackFuser

Define two tracking sources: one internal and one external. The `SourceIndex` of each source must be unique.

```
internalSource = fuserSourceConfiguration(1, 'IsInternalSource', true);
externalSource = fuserSourceConfiguration(2, 'IsInternalSource', false);
```

Create a `trackFuser` with `FuserIndex` equal to 3. The fuser takes the two sources defined above and uses the 'Cross' StateFusion model.

```
fuser = trackFuser('FuserIndex', 3, 'MaxNumSources', 2, ...
    'SourceConfigurations', {internalSource; externalSource}, ...
    'StateFusion', 'Cross');
```

Update the fuser with two tracks from the two sources. Use a 3-D constant velocity state, in which the states are given in the order of $[x; vx; y; vy; z; vz]$. The states of the two tracks are the same, but their covariances are different. For the first track, create a large covariance in the x -axis. For the second track, create a large covariance in the y -axis.

```
tracks = [objectTrack('SourceIndex', 1, 'State', [10; 0; 0; 0; 0; 0], ...
    'StateCovariance', diag([100, 1000, 1, 10, 1, 10])); ...
    objectTrack('SourceIndex', 2, 'State', [10; 0; 0; 0; 0; 0], ...
    'StateCovariance', diag([1, 10, 100, 1000, 1, 10]));
```

Fuse the track with fusion time equal to 0.

```
time = 0;
confirmedTracks = fuser(tracks, time);
```

Obtain the positions and position covariances of the source tracks and confirmed tracks.

```
positionSelector = [1 0 0 0 0 0; 0 0 1 0 0 0; 0 0 0 0 1 0]; % [x; y; z]
[inputPos,inputCov] = getTrackPositions(tracks,positionSelector);
[outputPos,outputCov] = getTrackPositions(confirmedTracks,positionSelector);
```

Visualize the results using trackPlotter.

```
tPlotter = theaterPlot('XLim',[0, 20],'YLim',[-10, 10],'ZLim',[-10, 10]);
tPlotter1 = trackPlotter(tPlotter,'DisplayName','Input Tracks','MarkerEdgeColor','blue');
tPlotter2 = trackPlotter(tPlotter,'DisplayName','Fused Tracks','MarkerEdgeColor','green');

plotTrack(tPlotter1,inputPos,inputCov)
plotTrack(tPlotter2,outputPos,outputCov)
title('Cross-covariance fusion')
```

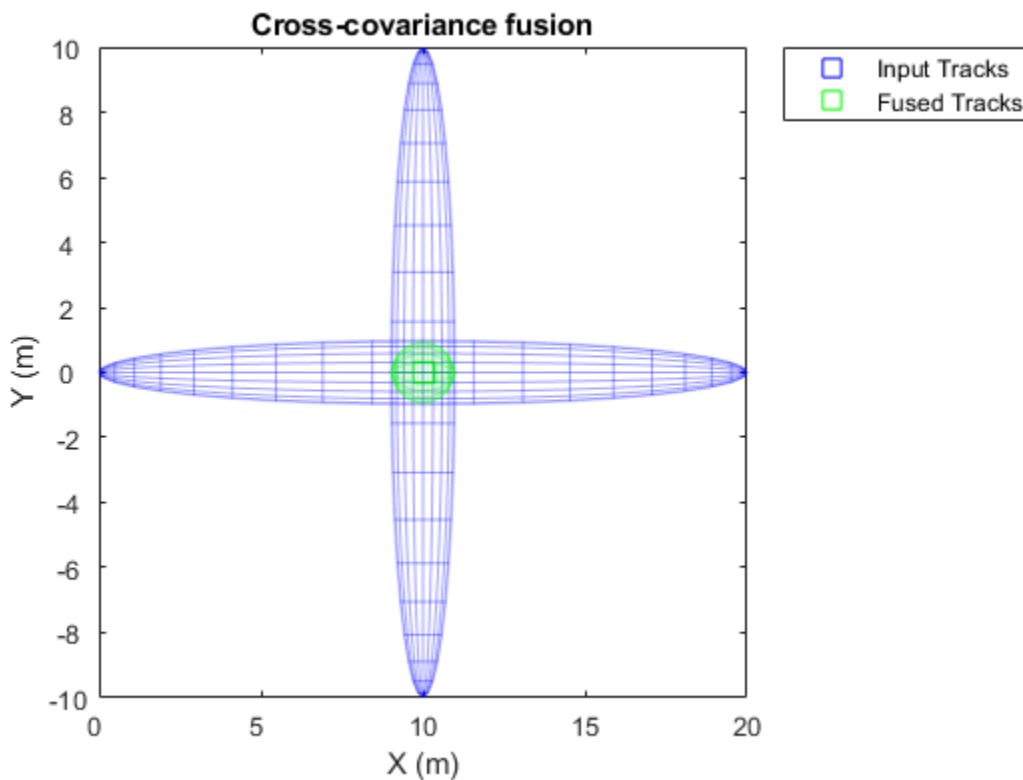

References

- [1] Blackman, S. and Popoli, R., 1999. *Design and analysis of modern tracking systems*(Book). Norwood, MA: Artech House, 1999.
- [2] Chong, Chee-Yee, Shozo Mori, William H. Barker, and Kuo-Chu Chang. "Architectures and algorithms for track association and fusion." *IEEE Aerospace and Electronic Systems Magazine* 15, no. 1 (2000): 5-13.

- [3] Tian, Xin, Yaakov Bar-Shalom, D. Choukroun, Y. Oshman, J. Thienel, and M. Idan. "Track-to-Track Fusion Architectures-A Review." In book "Advances in Estimation, Navigation, and Spacecraft Control". Springer, 2015.

Extended Capabilities

C/C++ Code Generation

Generate C and C++ code using MATLAB® Coder™.

Usage notes and limitations:

- See "System Objects in MATLAB Code Generation" (MATLAB Coder).
- You must specify the `MaxNumSources` property during construction. Also, the property is read only for code generation.
- You must specify the `SourceConfigurations` property for all the sources during construction. Additionally,
 - All elements of `SourceConfigurations` must use the same `LocalToCentralTransformFcn`.
 - All elements of `SourceConfigurations` must use the same `CentralToLocalTransformFcn`.
- The input tracks must be a struct array instead of an `objectTrack` object array.
- The track outputs (all three) are each a struct array instead of an `objectTrack` object array.
- The `ObjectAttributes` structure for all the input source tracks must be in the same format (same field names and data types).
- The `StateParameters` structure for all the input source tracks must be in the same format (same field names and data types) as the `StateParameters` structure of the track fuser.

See Also

`objectTrack` | `trackerGNN` | `trackerJPDA` | `trackerPHD` | `trackerTOMHT`

External Websites

"Introduction to Track-To-Track Fusion"

Introduced in R2019b

deleteTrack

Delete existing track

Syntax

```
deleted = deleteTrack(obj,trackID)
```

Description

`deleted = deleteTrack(obj,trackID)` deletes the track specified by `trackID` in the tracker or track fuser object, `obj`.

Examples

Delete track

Create a track using detections in a GNN tracker.

```
tracker = trackerGNN;  
detection1 = objectDetection(0,[1;1;1]);  
detection2 = objectDetection(1,[1.1;1.2;1.1]);  
tracker(detection1,0);  
tracker(detection2,1)
```

```
ans =  
  objectTrack with properties:  
  
    TrackID: 1  
   BranchID: 0  
  SourceIndex: 0  
   UpdateTime: 1  
        Age: 2  
        State: [6x1 double]  
  StateCovariance: [6x6 double]  
  StateParameters: [1x1 struct]  
   ObjectClassID: 0  
   TrackLogic: 'History'  
  TrackLogicState: [1 1 0 0 0]  
   IsConfirmed: 1  
   IsCoasted: 0  
  IsSelfReported: 1  
  ObjectAttributes: [1x1 struct]
```

Delete the first track.

```
deleted1 = deleteTrack(tracker,1)  
  
deleted1 = logical  
         1
```

Uncomment the following to delete a nonexistent track. A warning will be issued.

```
% deleted2 = deleteTrack(tracker,2)
```

Input Arguments

obj — Tracker or fuser object

trackerTOMHT object | trackerJPDA object | trackerGNN object | trackerPHD object | trackFuser object

Tracker or fuser object, specified as a trackerTOMHT, trackerJPDA, trackerGNN, trackerPHD, or trackFuser object.

trackID — Track identifier

positive integer

Track identifier, specified as a positive integer.

Example: 21

Output Arguments

deleted — Indicate if track was successfully deleted

1 | 0

Indicate if the track was successfully deleted or not, returned as 1 or 0. If the track specified by the trackID input existed and was successfully deleted, it returns as 1. If the track did not exist, a warning is issued and it returns as 0.

Extended Capabilities

C/C++ Code Generation

Generate C and C++ code using MATLAB® Coder™.

See Also

trackFuser | trackerGNN | trackerJPDA | trackerPHD | trackerTOMHT

Introduced in R2020a

initializeTrack

Initialize new track

Syntax

```
trackID = initializeTrack(obj,track)
trackID = initializeTrack(obj,track,filter)
```

Description

`trackID = initializeTrack(obj,track)` initializes a new track in the tracker or track fuser object, `obj`. The tracker or fuser must be updated at least once before initializing a track. If the track is initialized successfully, the tracker or fuser assigns the output `trackID` to the track, sets the `UpdateTime` of the track equal to the last step time in the tracker, and synchronizes the data in the input `track` to the initialized track.

A warning is issued if the tracker or track fuser already maintains the maximum number of tracks specified by its `MaxNumTracks` property. In this case, the `trackID` is returned as `0`, which indicates a failure to initialize the track.

Note This syntax doesn't support using the `trackingGSF`, `trackingPF`, or `trackingIMM` filter object as the internal tracking filter for the tracker or track fuser. Use the second syntax in these cases.

`trackID = initializeTrack(obj,track,filter)` initializes a new track in the tracker or track fuser object, `obj`, using a specified tracking filter, `filter`.

Note

- If the tracking filter used in the tracker or track fuser is `trackingGSF`, `trackingPF`, or `trackingIMM`, you must use this syntax instead of the first syntax.
 - This syntax does not support using `trackFuser` as the `obj` input.
-

Examples

Initialize Track

Create a GNN tracker and update the tracker with detections at $t = 0$ and $t = 1$ second.

```
tracker = trackerGNN
```

```
tracker =  
    trackerGNN with properties:
```

```
    TrackerIndex: 0
```



```

    FilterInitializationFcn: 'initcvekf'
        Assignment: 'MatchPairs'
    AssignmentThreshold: [30 Inf]
    MaxNumTracks: 100
    MaxNumSensors: 20

    OOSMHandling: 'Terminate'

    TrackLogic: 'History'
    ConfirmationThreshold: [2 3]
    DeletionThreshold: [5 5]

    HasCostMatrixInput: false
    HasDetectableTrackIDsInput: false
    StateParameters: [1x1 struct]

    NumTracks: 0
    NumConfirmedTracks: 0

```

```

detection1 = objectDetection(0,[1;1;1]);
detection2 = objectDetection(1,[1.1;1.2;1.1]);
tracker(detection1,0);
currentTrack = tracker(detection2,1);

```

As seen from the NumTracks property, the tracker now maintains one track.

tracker

tracker =

trackerGNN with properties:

```

    TrackerIndex: 0
    FilterInitializationFcn: 'initcvekf'
        Assignment: 'MatchPairs'
    AssignmentThreshold: [30 Inf]
    MaxNumTracks: 100
    MaxNumSensors: 20

    OOSMHandling: 'Terminate'

    TrackLogic: 'History'
    ConfirmationThreshold: [2 3]
    DeletionThreshold: [5 5]

    HasCostMatrixInput: false
    HasDetectableTrackIDsInput: false
    StateParameters: [1x1 struct]

    NumTracks: 1
    NumConfirmedTracks: 1

```

Create a new track using the objectTrack object.

```
newTrack = objectTrack()
```

newTrack =

objectTrack with properties:

```
        TrackID: 1
        BranchID: 0
    SourceIndex: 1
    UpdateTime: 0
        Age: 1
        State: [6x1 double]
    StateCovariance: [6x6 double]
    StateParameters: [1x1 struct]
    ObjectClassID: 0
        TrackLogic: 'History'
    TrackLogicState: 1
        IsConfirmed: 1
        IsCoasted: 0
    IsSelfReported: 1
    ObjectAttributes: [1x1 struct]
```

Initialize a track in the GNN tracker object using the newly created track.

```
trackID = initializeTrack(tracker,newTrack)

trackID = uint32
    2
```

As seen from the NumTracks property, the tracker now maintains two tracks.

```
tracker

tracker =
    trackerGNN with properties:

        TrackerIndex: 0
    FilterInitializationFcn: 'initcvekf'
        Assignment: 'MatchPairs'
    AssignmentThreshold: [30 Inf]
        MaxNumTracks: 100
        MaxNumSensors: 20

        OOSMHandling: 'Terminate'

        TrackLogic: 'History'
    ConfirmationThreshold: [2 3]
    DeletionThreshold: [5 5]

        HasCostMatrixInput: false
    HasDetectableTrackIDsInput: false
        StateParameters: [1x1 struct]

        NumTracks: 2
    NumConfirmedTracks: 2
```

Input Arguments

obj — Tracker or fuser object

trackerTOMHT object | trackerJPDA object | trackerGNN object | trackFuser object

Tracker or fuser object, specified as a `trackerTOMHT`, `trackerJPDA`, `trackerGNN`, or `trackFuser` object.

track — New track to be initialized

`objectTrack` object | structure

New track to be initialized, specified as an `objectTrack` object or a structure. If specified as a structure, the name, variable type, and data size of the fields of the structure must be the same as the name, variable type, and data size of the corresponding properties of the `objectTrack` object.

Data Types: `struct` | `object`

filter — Filter object

`trackingKF` | `trackingEKF` | `trackingUKF` | `trackingABF` | `trackingCKF` | `trackingMSCEKF` | `trackingPF` | `trackingIMM` | `trackingGSF`

Filter object, specified as a `trackingKF`, `trackingEKF`, `trackingUKF`, `trackingABF`, `trackingCKF`, `trackingIMM`, `trackingGSF`, `trackingPF`, or `trackingMSCEKF` object.

Output Arguments

trackID — Track identifier

nonnegative integer

Track identifier, returned as a nonnegative integer. `trackID` is returned as 0 if the track is not initialized successfully.

Example: 2

Extended Capabilities

C/C++ Code Generation

Generate C and C++ code using MATLAB® Coder™.

See Also

`trackFuser` | `trackerGNN` | `trackerJPDA` | `trackerTOMHT`

Introduced in R2020a

sourceIndices

Fuser source indices

Syntax

```
indices = sourceIndices(fuser)
```

Description

`indices = sourceIndices(fuser)` returns the `SourceIndex` values of the `fuserSourceConfiguration` objects contained in the `SourceConfigurations` property of the track fuser.

Examples

Obtain Source Indices of Track Fuser

Define two sources using the `fuserSourceConfiguration` objects.

```
source1 = fuserSourceConfiguration(1, 'IsInternalSource', true);  
source2 = fuserSourceConfiguration(2, 'IsInternalSource', false);
```

Create a track fuser with the two sources.

```
fuser = trackFuser('FuserIndex', 3, 'SourceConfigurations', {source1; source2});
```

Obtain the source indices.

```
indices = sourceIndices(fuser)
```

```
indices = 1×2
```

```
    1    2
```

Input Arguments

fuser — Track fuser

`trackFuser` object

Track fuser, specified as a `trackFuser` object.

Output Arguments

indices — Indices of sources

row-vector of nonnegative integers

Indices of sources, return as a row-vector of nonnegative integers.

Extended Capabilities

C/C++ Code Generation

Generate C and C++ code using MATLAB® Coder™.

Introduced in R2021a

trackOSPAMetric

Optimal subpattern assignment (OSPA) metric

Description

`trackOSPAMetric` System object computes the optimal subpattern assignment metric between a set of tracks and the known truths. An OSPA metric contains three components:

- Localization error component — Accounts for state estimation errors between assigned tracks and truths
- Cardinality error component— Accounts for the number of unassigned tracks and truths
- Labelling error component — Accounts for the error of incorrect assignment

For more details, see “OSPA Metric” on page 3-434 and [2].

To use `trackOSPAMetric`:

- 1 Create the `trackOSPAMetric` object and set its properties.
- 2 Call the object with arguments, as if it were a function.

To learn more about how System objects work, see [What Are System Objects?](#).

Creation

Syntax

```
OSPAMetric = trackOSPAMetric  
OSPAMetric = trackOSPAMetric(Name,Value)
```

Description

`OSPAMetric = trackOSPAMetric` creates a `trackOSPAMetric` System object, `OSPAMetric`, with default property values.

`OSPAMetric = trackOSPAMetric(Name,Value)` sets properties for the `trackOSPAMetric` object using one or more name-value pairs. For example, `OSPAMetric = trackOSPAMetric('CutoffDistance',5)` creates a `trackOSPAMetric` object with the cut off distance equal to 5. Enclose property names in single quotes.

Properties

Unless otherwise indicated, properties are *nontunable*, which means you cannot change their values after calling the object. Objects lock when you call them, and the `release` function unlocks them.

If a property is *tunable*, you can change its value at any time.

For more information on changing property values, see System Design in MATLAB Using System Objects.

CutoffDistance — Threshold for cutoff distance between track and truth

30 (default) | real positive scalar

Threshold for cutoff distance between track and truth, specified as a real positive scalar. If the computed distance between a track and the assigned truth is higher than the threshold, the actual distance incorporated in the metric is reduced to the threshold.

Example: 40

Data Types: single | double

Order — Order of OSPA metric

2 (default) | positive integer

Order of OSPA metric, specified as a positive integer.

Example: 10

Data Types: single | double

LabelingError — Penalty for incorrect assignment

0 (default) | real scalar in [0, CutoffDistance]

Penalty for incorrect assignment of track to truth, specified as a real positive scalar. The function decides if an assignment is correct based on the provided known assignment input. If the assignment is not provided as an input, the last known "optimal" assignment is assumed to be correct.

Example: 5

Data Types: single | double

Distance — Distance type

'posnees' (default) | 'velnees' | 'posabserr' | 'velabserr'

Distance type, specified as 'posnees', 'velnees', 'posabserr', or 'velabserr'. The distance type specifies the physical quantity used for distance calculations:

- 'posnees' - Normalized estimation error squared (NEES) of track position
- 'velnees' - NEES error of track velocity
- 'posabserr' - Absolute error of track position
- 'velabserr' - Absolute error of track velocity
- 'custom' - Custom distance error

If you specify the Distance property as 'custom', you must also specify the distance function in the DistanceFcn property.

DistanceFcn — Custom distance function

function handle

Custom distance function, specified as a function handle. The function must support the following syntax:

```
d = myCustomFcn(Track, Truth)
```

where `Track` is a structure or an object of track information, `Truth` is a structure or an object of truth information, and `d` is the distance between the truth and the track. See `objectTrack` for an example on how to organize track information.

Example: `@myCustomFcn`

Dependencies

To enable this property, set the `Distance` property to `'custom'`.

MotionModel — Desired platform motion model

`'constvel'` (default) | `'constacc'` | `'constturn'` | `'singer'`

Desired platform motion model, specified as `'constvel'`, `'constacc'`, `'constturn'`, or `'singer'`. This property selects the motion model used by the `tracks` input.

The motion models expect the `'State'` field of the `tracks` to have a column vector containing these values:

- `'constvel'` — Position is in elements [1 3 5], and velocity is in elements [2 4 6].
- `'constacc'` — Position is in elements [1 4 7], velocity is in elements [2 5 8], and acceleration is in elements [3 6 9].
- `'constturn'` — Position is in elements [1 3 6], velocity is in elements [2 4 7], and yaw rate is in element 5.
- `'singer'` — Position is in elements [1 4 7], velocity is in elements [2 5 8], and acceleration is in elements [3 6 9].

The `'StateCovariance'` field of the `tracks` input must have position, velocity, and turn-rate covariances in the rows and columns corresponding to the position, velocity, and turn-rate of the `'State'` field of the `tracks` input.

TrackIdentifierFcn — Track identifier function

`@defaultTrackIdentifier` (default) | function handle

Track identifier function, specified as a function handle. The function extracts track ID from the track input. The function must support the following syntax:

```
Trackids = trackIdentifier(Tracks)
```

where `Tracks` is an array of structures or objects containing the information of tracks, and `Trackids` is a numeric array of the same size as `Tracks`. For an example of track object, see `objectTrack`. For the default identifier function, `defaultTrackIdentifier`, the track ID must be contained in `Tracks` as the value of the `TrackID` field or property.

Example: `@myTrackIdentifier`

TruthIdentifierFcn — Truth identifier function

`@defaultTruthIdentifier` (default) | function handle

Truth identifier function, specified as a function handle. The function extracts truth ID from truth input. The function must support the following syntax:

```
TruthIDs = truthIdentifier(Truths)
```

where `Truths` is an array of structures or objects containing the information of truths, and `TruthIDs` is a numeric array of the same size as `Truths`. For the use of the default identifier

function, `defaultTruthIdentifier`, the truth ID must be contained in `Truth` as a value of the `PlatformID` field or property.

Example: `@myTruthIdentifier`

HasAssignmentInput — Enable assignment input

false (default) | true

Enable assignment input, specified as true or false.

Data Types: logical

Usage

Syntax

```

OSPA = OSPAMetric(tracks,truths)
OSPA = OSPAMetric(tracks,truths,assignment)
[OSPA,localOSPA] = OSPAMetric(____)
[OSPA,localOSPA,cardOSPA] = OSPAMetric(____)
[OSPA,localOSPA,cardOSPA,labelOSPA] = OSPAMetric(____)

```

Description

`OSPA = OSPAMetric(tracks,truths)` returns the OSPA metric between the set of tracks and truths.

`OSPA = OSPAMetric(tracks,truths,assignment)` allows you to specify the known assignment between tracks and truths at the current time step. To use this syntax, specify the `HasAssignmentInput` property as true.

`[OSPA,localOSPA] = OSPAMetric(____)` also returns the localization error component of the OSPA metric. You can use any of the input combinations in the previous syntaxes as the input.

`[OSPA,localOSPA,cardOSPA] = OSPAMetric(____)` also returns the cardinality error component of the OSPA metric.

`[OSPA,localOSPA,cardOSPA,labelOSPA] = OSPAMetric(____)` also returns the labeling error component of the OSPA metric.

Input Arguments

tracks — Track information

array of structures | array of objects

Track information, specified as an array of structures or objects for noncustomized (built-in) distance functions. Each structure or object must contain `State` as a field or property. Additionally, if an NEES-based distance (`posnees` or `velnees`) is specified in the `Distance` property, each structure or object must also contain `StateCovariance` as a field or property. Moreover, if the default track identifier function is used in the `TrackIdentifierFcn` property, then each structure or object must also contain `TrackID` as a field or property.

Data Types: struct | object

truths — Truth information

array of structures | array of objects

Truth information, specified as an array of structures or objects for noncustomized (built-in) distance functions. Each structure or object must contain `Position` and `Velocity` as fields or properties. If the default truth identifier function is used in the `TruthIdentifierFcn` property, then each structure or object must also contain `PlatformID` as a field or property.

Data Types: `struct` | `object`**assignment — Known assignment***N*-by-2 matrix of nonnegative integers

Known assignment, specified as an *N*-by-2 matrix of nonnegative integers. The first column elements are track IDs, and the second column elements are truth IDs. The IDs in the same row are assigned to each other. If a track or truth is not assigned, specify 0 as the same row element.

Note that the assignment must be a unique assignment between tracks and truths. Redundant or false tracks should be treated as unassigned tracks by assigning them to the "0" TruthID.

Data Types: `single` | `double`**Output Arguments****OSPA — OSPA metric**

nonnegative real scalar

OSPA metric, returned as a nonnegative real scalar.

Example: 10.1

localOSPA — Localization error component

nonnegative real scalar

Localization error component, returned as a nonnegative real scalar.

Example: 8.5

cardOSPA — Cardinality error component

nonnegative real scalar

Cardinality error component, returned as a nonnegative real scalar.

Example: 6

labelOSPA — Labeling error component

nonnegative real scalar

Labeling error component, returned as a nonnegative real scalar.

Example: 7.5

Object Functions

To use an object function, specify the System object as the first input argument. For example, to release system resources of a System object named `obj`, use this syntax:

```
release(obj)
```

Common to All System Objects

step	Run System object algorithm
release	Release resources and allow changes to System object property values and input characteristics
reset	Reset internal states of System object
clone	Create duplicate System object

Examples

Evaluate Tracking Result Using trackOSPAMetric

Load prerecorded track data and truth data.

```
load trackmetricex tracklog truthlog
```

Construct a trackOSPAMetric object.

```
tom = trackOSPAMetric;
```

Initialize output variables.

```
ospa = zeros(numel(tracklog),1);
card0spa = zeros(numel(tracklog),1);
loc0spa = zeros(numel(tracklog),1);
```

Calculate three OSPA components in a loop.

```
for i = 1:numel(tracklog)
    tracks = tracklog{i};
    truths = truthlog{i};
    [ospa(i), loc0spa(i), card0spa(i)] = tom(tracks, truths);
end
```

Visualize the results.

```
figure()
plot(ospa, 'g');
hold on;
plot(loc0spa, 'r:');
plot(card0spa, 'b--');
legend('OSPA', 'Localization OSPA', 'Cardinality OSPA');
```

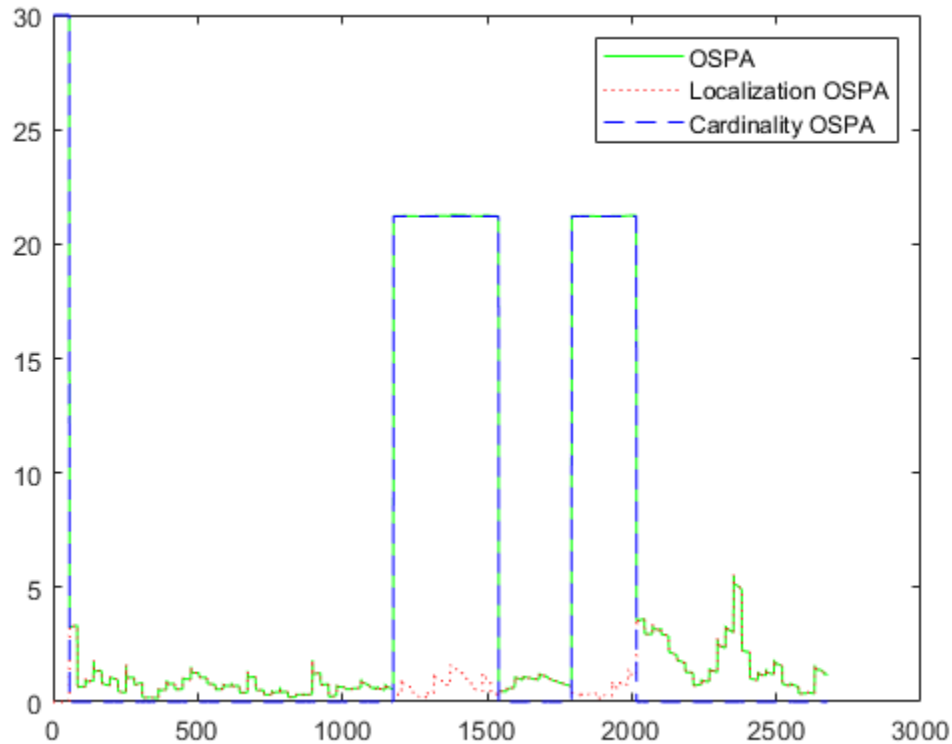

More About

OSPA Metric

At time t_k , a list of truths is:

$$X = [x_1, x_2, \dots, x_m]$$

At the same time, a tracker obtains a list of tracks:

$$Y = [y_1, y_2, \dots, y_n]$$

The OSPA metric (used to evaluate the tracking performance based on the truth) is:

$$OSPA = (d_{loc}^p + d_{card}^p + d_{lab}^p)^{1/p}$$

Assuming $m \leq n$, the three components (d_{loc} , d_{card} , and d_{lab}) are calculated as follows. The localization error component d_{loc} is computed as:

$$d_{loc} = \left\{ \frac{1}{n} \sum_{i=1}^m d_c^p(x_i, y_{\Pi(i)}) \right\}^{1/p}$$

where p is the order of the OSPA metric, d_c is the cutoff-based distance, and $y_{\Pi(i)}$ represents the track assigned to truth x_i . The cutoff-based distance d_c is defined as:

$$d_c(x, y) = \min\{d_b(x, y), c\}$$

where c is the cutoff distance threshold, and $d_b(x, y)$ is the base distance between track x and truth y calculated by the distance function. The cutoff based distance d_c takes the smaller value of d_b and c .

The cardinality error component d_{card} is:

$$d_{card} = \left\{ \frac{n - m}{n} c^p \right\}^{1/p}$$

The labeling error component d_{lab} is:

$$d_{lab} = \left\{ \frac{1}{n} \sum_{i=1}^m \alpha^p \gamma(L(x_i), L(y_{\Pi(i)})) \right\}^{1/p}$$

where α is the penalty for incorrect assignment, $L(x_i)$ represents the truth ID of x_i , and $L(y_{\pi(i)})$ represents the track ID of $y_{\pi(i)}$. The function $\gamma = 1$ if the IDs of the truth and track pair ($L(x_i)$ and $L(y_{\pi(i)})$) agree with the known assignment given by the `assignment` input, or agree with the assignment in the last update if the known assignment is not given. Otherwise, $\gamma = 0$.

If $m > n$, simply exchange m and n in the formulation to obtain the OSPA metric.

References

- [1] Schuhmacher, B., B. -T. Vo, and B. -N. Vo. "A Consistent Metric for Performance Evaluation of Multi-Object Filters." *IEEE Transactions on Signal Processing*, Vol, 56, No, 8, pp. 3447-3457, 2008.
- [2] Ristic, B., B. -N. Vo, D. Clark, and B. -T. Vo. "A Metric for Performance Evaluation of Multi-Target Tracking Algorithms." *IEEE Transactions on Signal Processing*, Vol, 59, No, 7, pp. 3452-3457, 2011.

Extended Capabilities

C/C++ Code Generation

Generate C and C++ code using MATLAB® Coder™.

See Also

`trackAssignmentMetrics` | `trackErrorMetrics` | `trackGOSPAMetric`

Introduced in R2019b

trackGOSPAMetric

Generalized optimal subpattern assignment (GOSPA) metric

Description

`trackGOSPAMetric` System object computes the generalized optimal subpattern assignment metric between a set of tracks and the known truths.

For more details, see “GOSPA Metric” on page 3-443 and [1].

To compute the generalized subpattern alignment metric:

- 1 Create the `trackGOSPAMetric` object and set its properties.
- 2 Call the object with arguments, as if it were a function.

To learn more about how System objects work, see [What Are System Objects?](#).

Creation

Syntax

```
GOSPAMetric = trackGOSPAMetric
GOSPAMetric = trackGOSPAMetric(Name,Value)
```

Description

`GOSPAMetric = trackGOSPAMetric` creates a `trackGOSPAMetric` System object with default property values.

`GOSPAMetric = trackGOSPAMetric(Name,Value)` sets properties for the `trackGOSPAMetric` object using one or more name-value pairs. For example, `GOSPAMetric = trackGOSPAMetric('CutoffDistance',5)` creates a `trackGOSPAMetric` object with the cutoff distance equal to 5. Enclose property names in quotes.

Properties

Unless otherwise indicated, properties are *nontunable*, which means you cannot change their values after calling the object. Objects lock when you call them, and the `release` function unlocks them.

If a property is *tunable*, you can change its value at any time.

For more information on changing property values, see [System Design in MATLAB Using System Objects](#).

CutoffDistance — Threshold for cutoff distance between track and truth

30 (default) | real positive scalar

Threshold for cutoff distance between track and truth, specified as a real positive scalar. A truth is assigned to a track only if the distance between the track and the known truth is less than this distance.

Example: 40

Data Types: `single` | `double`

Order — Order of GOSPA metric

2 (default) | positive integer

Order of GOSPA metric, specified as a positive integer.

Example: 1

Data Types: `single` | `double`

Alpha — Alpha parameter of GOSPA metric

2 (default) | positive scalar in range [0, 2]

Alpha parameter of GOSPA metric, specified as a positive scalar in the range [0, 2].

Example: 1

Data Types: `single` | `double`

SwitchingPenalty — Penalty for assignment switching

0 | nonnegative real scalar

Penalty for assignment switching, specified as a nonnegative real scalar.

Example: 1.2

Distance — Distance type

'posnees' (default) | 'velnees' | 'posabserr' | 'velabserr' | 'custom'

Distance type, specified as 'posnees', 'velnees', 'posabserr', 'velabserr', or 'custom'. This property specifies the physical quantity used for distance calculations:

- 'posnees' - Normalized estimation error squared (NEES) of track position
- 'velnees' - NEES error of track velocity
- 'posabserr' - Absolute error of track position
- 'velabserr' - Absolute error of track velocity
- 'custom' - Custom distance error

If you specify the Distance property as 'custom', you must also specify the distance function in the DistanceFcn property.

DistanceFcn — Custom distance function

function handle

Custom distance function, specified as a function handle. The function must support this syntax:

```
d = myCustomFcn(track, truth)
```

where `track` is a structure or an object of track information, `truth` is a structure or an object of truth information, and `d` is the distance between the truth and the track. See `objectTrack` for an example on how to organize information for estimated tracks and truth tracks.

Example: `@myCustomFcn`

Dependencies

To enable this property, set the `Distance` property to `'custom'`.

MotionModel — Desired platform motion model

`'constvel'` (default) | `'constacc'` | `'constturn'` | `'singer'`

Desired platform motion model, specified as `'constvel'`, `'constacc'`, `'constturn'`, or `'singer'`. This property selects the motion model used by the `tracks` input.

The motion models expect the `'State'` field of the `tracks` input to have a column vector containing these values:

- `'constvel'` — Constant velocity motion model of the form $[x;vx;y;vy;z;vz]$, where x , y , and z are position coordinates and vx , vy , vz are velocity coordinates.
- `'constacc'` — Constant acceleration motion model of the form $[x;vx;ax;y;vy;ay;z;vz;az]$, where x , y , and z are position coordinates, vx , vy , vz are velocity coordinates, and ax , ay , az are acceleration coordinates.
- `'constturn'` — Constant turn motion model of the form $[x;vx;y;vy;theta;z;vz]$, where x , y , and z are position coordinates, vx , vy , vz are velocity coordinates, and $theta$ is the yaw rate.
- `'singer'` — Singer acceleration motion model of the form $[x;vx;ax;y;vy;ay;z;vz;az]$, where x , y , and z are position coordinates, vx , vy , vz are velocity coordinates, and ax , ay , az are acceleration coordinates.

The `'StateCovariance'` field of the `tracks` input must have position, velocity, and turn-rate covariances in the rows and columns corresponding to the position, velocity, and turn-rate of the `'State'` field of the `tracks` input. `'StateCovariance'` is required only if `'posnees'` or `'velnees'` is selected in the `Distance` property.

TrackIdentifierFcn — Track identifier function

`@defaultTrackIdentifier` (default) | function handle

Track identifier function, specified as a function handle. The function extracts track ID from the `tracks` input. The function must support the following syntax:

```
trackids = trackIdentifier(tracks)
```

where

- `tracks` is an array of structures or objects containing the information of tracks.
- `trackids` is a numeric array of the same size as `tracks`.

For an example of a track object, see `objectTrack`. If you use the default identifier function, `defaultTrackIdentifier`, you must include track ID in `tracks` as the value of the `TrackID` field or property.

Example: `@myTrackIdentifier`

TruthIdentifierFcn — Truth identifier function

`@defaultTruthIdentifier` (default) | function handle

Truth identifier function, specified as a function handle. The function extracts truth ID from `truths` input. The function must support the following syntax:

```
truthIDs = truthIdentifier(truths)
```

where

- `truths` is an array of structures or objects containing the information of truths.
- `truthIDs` is a numeric array of the same size as `truths`.

If you the use of the default identifier function, `defaultTruthIdentifier`, you must include the truth ID in `truths` as a value of the `PlatformID` field or property.

Example: `@myTruthIdentifier`

HasAssignmentInput — Enable assignment input

`false` (default) | `true`

Enable assignment input, specified as `true` or `false`. This property enables providing the assignment input at each time step. The computed GOSPA metric uses the input assignment to compute the localization component.

Data Types: `logical`

Usage

Syntax

```
sGOSPA = GOSPAMetric(tracks,truths)
[sGOSPA,GOSPA,switching] = OSPAMetric(tracks,truths)
[ ___ ] = GOSPAMetric(tracks,truths,assignment)
[sGOSPA,GOSPA,switching,localization,missTarget,falseTrack] = GOSPAMetric( ___
)
```

Description

`sGOSPA = GOSPAMetric(tracks,truths)` returns the GOSPA metric between the set of tracks and truths, including the switching penalty. The value of the switching penalty included in the metric depends on the `SwitchingPenalty` property. By default, the metric uses the global nearest neighbor (GNN) assignments at the current and the previous step to decide if the tracks are switched.

`[sGOSPA,GOSPA,switching] = OSPAMetric(tracks,truths)` also returns the GOSPA component and the switching component.

`[___] = GOSPAMetric(tracks,truths,assignment)` allows you the specify the current assignments between tracks and truths used in the metric evaluation. You can return outputs as any of the previous syntaxes.

To use this syntax, set the `HasAssignmentInput` property to `true`.

`[sGOSPA,GOSPA,switching,localization,missTarget,falseTrack] = GOSPAMetric(___)` also returns the localization component, missed target component, and the false track component. You can use any of the input combinations in the previous syntaxes.

To use this syntax, set the value of the `Alpha` property to 2.

Input Arguments

tracks — Track information

array of structures | array of objects

Track information, specified as an array of structures or objects for built-in distance functions. Each structure or object must contain `State` as a field or property. Additionally, if a NEES-based distance (`posnees` or `velnees`) is specified in the `Distance` property, each structure or object must also contain `StateCovariance` as a field or property. Moreover, if the default track identifier function is used in the `TrackIdentifierFcn` property, then each structure or object must also contain `TrackID` as a field or property. See `objectTrack` for an example of track object.

Data Types: `struct` | `object`

truths — Truth information

array of structures | array of objects

Truth information, specified as an array of structures or objects for built-in distance functions. Each structure or object must contain `Position` and `Velocity` as fields or properties. If the default truth identifier function is used in the `TruthIdentifierFcn` property, then each structure or object must also contain `PlatformID` as a field or property.

Data Types: `struct` | `object`

assignment — Known current assignment

N -by-2 matrix of nonnegative integers

Known current assignment, specified as an N -by-2 matrix of nonnegative integers. The first column elements are track IDs, and the second column elements are truth IDs. The IDs in the same row are tracks and truths assigned to each other. If a track (or a truth) is not assigned, specify 0 as the same row element for the truth (or the track).

Note that the assignment must be a unique assignment between tracks and truths. Redundant or false tracks should be treated as unassigned tracks by assigning them to the "0" TruthID.

Data Types: `single` | `double`

Output Arguments

sGOSPA — GOSPA metric including switching component

nonnegative real scalar

GOSPA metric including switching component, returned as a nonnegative real scalar.

GOSPA — GOSPA metric

nonnegative real scalar

GOSPA metric, returned as a nonnegative real scalar.

switching — Switching component

nonnegative real scalar

Switching component, returned as a nonnegative real scalar.

localization — Localization component

nonnegative real scalar

Localization component, returned as a nonnegative real scalar.

missTarget — Missed target component

nonnegative real scalar

Missed target component, returned as a nonnegative real scalar.

falseTrack — False track component

nonnegative real scalar

False track component, returned as a nonnegative real scalar.

Object Functions

To use an object function, specify the System object as the first input argument. For example, to release system resources of a System object named `obj`, use this syntax:

```
release(obj)
```

Common to All System Objects

<code>step</code>	Run System object algorithm
<code>release</code>	Release resources and allow changes to System object property values and input characteristics
<code>reset</code>	Reset internal states of System object
<code>clone</code>	Create duplicate System object
<code>isLocked</code>	Determine if System object is in use

Examples

Evaluate Tracking Results Using GOSPA Metric

Load prerecorded data.

```
load trackmetricex tracklog truthlog;
```

Create a `trackGOSPAMetric` object and set the `SwitchingPenalty` to 5.

```
tgm = trackGOSPAMetric('SwitchingPenalty',5);
```

Create output variables.

```
lgospa = zeros(numel(tracklog),1);  
gospa = zeros(numel(tracklog),1);  
switching = zeros(numel(tracklog),1);  
localization = zeros(numel(tracklog),1);  
missTarget = zeros(numel(tracklog),1);  
falseTracks = zeros(numel(tracklog),1);
```

After extracting the tracks and ground truths, run the GOSPA metric.

```
for i = 1:numel(tracklog)  
    tracks = tracklog{i};  
    truths = truthlog{i};
```

```
[lgospa(i),gospa(i),switching(i),localization(i),missTarget(i),falseTracks(i)] = tgm(tracks,
end
```

Visualize the results.

```
plot([lgospa gospa switching localization missTarget falseTracks])
legend('Labeled GOSPA','GOSPA','Switching Component',...
'Localization Component','Missed Target Component','False Tracks Component')
```

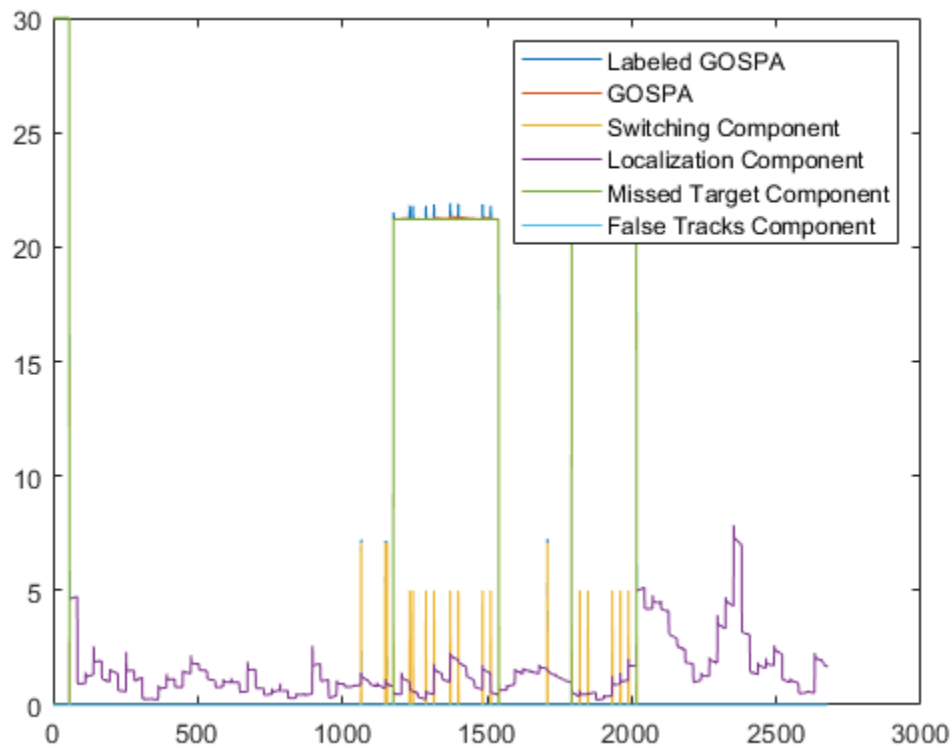

Algorithms

GOSPA Metric

At time t_k , a list of truths is:

$$X = [x_1, x_2, \dots, x_m]$$

At time t_k , a tracker obtains a list of tracks:

$$Y = [y_1, y_2, \dots, y_n]$$

In general, the GOSPA metric including the switching component (*SGOSPA*) is:

$$SGOSPA = (GOSPA^p + SC^p)^{1/p}$$

where p is the order of the metric, SC is the switching component, and *GOSPA* is the basic *GOSPA* metric.

Assuming $m \leq n$, *GOSPA* is:

$$GOSPA = \left[\sum_{i=0}^m d_c^p(x_i, y_{\Pi(i)}) + \frac{c^p}{\alpha}(n - m) \right]^{1/p}$$

where d_c is the cutoff-based distance and $y_{\Pi(i)}$ represents the track assigned to truth x_i . The cutoff-based distance d_c is defined as:

$$d_c(x, y) = \min\{d_b(x, y), c\}$$

where c is the cutoff distance threshold, and $d_b(x, y)$ is the base distance between track x and truth y calculated by the distance function. The cutoff based distance d_c is the smaller value of d_b and c . α is the alpha parameter.

The switching component SC is:

$$SC = SP \times n_s^{1/p}$$

where SP is the switching penalty and n_s is the number of switches. When a track switches assignment from one truth to another truth, the number of switching is counted as 1. When a track switches from assigned to unassigned or switches from unassigned to assigned, the number of switching is counted as 0.5. For example, as shown in the table, Tracks 1 and 2 both switched to

different truths, whereas Track 3 switched from assigned to unassigned. Therefore, the total number of switching is 2.5.

Track Switching Scenario

Previous		Current	
Tracks	Truths	Tracks	Truths
1	3	1	7
2	5	2	3
3	7	3	0

When $\alpha = 2$, the GOSPA metric can reduce to three components:

$$GOSPA = [loc^p + miss^p + false^p]^{1/p}$$

The localization component (loc) is calculated as:

$$loc = \left[\sum_{i=1}^h d_b^p(x_i, y_{\Pi(i)}) \right]^{1/p}$$

where h is the number of nontrivial assignments. A trivial assignment is when a track is assigned to no truth. The missed target component is calculated as:

$$miss = \frac{c}{2^{1/p}} (n_{miss})^{1/p}$$

where n_{miss} is the number of missed targets. The false track component is calculated as:

$$false = \frac{c}{2^{1/p}} (n_{false})^{1/p}$$

where n_{false} is the number of false tracks.

If $m > n$, simply exchange m and n in the formulation to obtain the GOSPA metric.

References

- [1] Rahmathullash, A. S., A. F. García-Fernández, and L. Svensson. "Generalized Optimal Sub-Pattern Assignment Metric." *20th International Conference on Information Fusion (Fusion)*, pp. 1-8, 2017.

Extended Capabilities

C/C++ Code Generation

Generate C and C++ code using MATLAB® Coder™.

See Also

[trackAssignmentMetrics](#) | [trackErrorMetrics](#) | [trackOSPAMetric](#)

Introduced in R2020a

trackerTOMHT

Multi-hypothesis, multi-sensor, multi-object tracker

Description

The trackerTOMHT System object is a multi-hypothesis tracker capable of processing detections of many targets from multiple sensors. The tracker initializes, confirms, predicts, corrects, and deletes tracks. Inputs to the tracker are detection reports generated by `objectDetection`, `fusionRadarSensor`, `irSensor`, or `sonarSensor` objects. The tracker estimates the state vector and state vector covariance matrix for each track. The tracker assigns detections based on a track-oriented, multi-hypothesis approach. Each detection is assigned to at least one track. If the detection cannot be assigned to any track, the tracker creates a track.

Any new track starts in a *tentative* state. If enough detections are assigned to a tentative track, its status changes to *confirmed*. If the detection already has a known classification (the `ObjectClassID` field of the returned track is nonzero), that track is confirmed immediately. When a track is confirmed, the multi-object tracker considers the track to represent a physical object. If detections are not assigned to the track within a specifiable number of updates, the track is deleted. For an overview of how the tracker functions, see “Algorithms” on page 3-458.

To track objects using the multi-hypothesis tracker:

- 1 Create the `trackerTOMHT` object and set its properties.
- 2 Call the object with arguments, as if it were a function.

To learn more about how System objects work, see [What Are System Objects?](#).

Creation

Syntax

```
tracker = trackerTOMHT
tracker = trackerTOMHT(Name,Value)
```

Description

`tracker = trackerTOMHT` creates a `trackerTOMHT` System object with default property values.

`tracker = trackerTOMHT(Name,Value)` sets properties for the multi-object tracker using one or more name-value pairs. For example, `trackerTOMHT('FilterInitializationFcn',@initcvukf,'MaxNumTracks',100)` creates a multi-object tracker that uses a constant-velocity, unscented Kalman filter and allows a maximum of 100 tracks. Enclose each property name in quotes.

Properties

Unless otherwise indicated, properties are *nontunable*, which means you cannot change their values after calling the object. Objects lock when you call them, and the `release` function unlocks them.

If a property is *tunable*, you can change its value at any time.

For more information on changing property values, see System Design in MATLAB Using System Objects.

TrackerIndex — Unique tracker identifier

0 (default) | nonnegative integer

Unique tracker identifier, specified as a nonnegative integer. This property is used as the `SourceIndex` in the tracker outputs, and distinguishes tracks that come from different trackers in a multiple-tracker system. You must specify this property as a positive integer to use the track outputs as inputs to a track fuser.

Example: 1

FilterInitializationFcn — Filter initialization function

@initcvckf (default) | function handle | character vector

Filter initialization function, specified as a function handle or as a character vector containing the name of a filter initialization function. The tracker uses a filter initialization function when creating new tracks.

Sensor Fusion and Tracking Toolbox supplies many initialization functions that you can use to specify `FilterInitializationFcn`.

Initialization Function	Function Definition
<code>initcvabf</code>	Initialize constant-velocity alpha-beta filter
<code>initcaabf</code>	Initialize constant-acceleration alpha-beta filter
<code>initcvekf</code>	Initialize constant-velocity extended Kalman filter.
<code>initcackf</code>	Initialize constant-acceleration cubature filter.
<code>initctckf</code>	Initialize constant-turn-rate cubature filter.
<code>initcvckf</code>	Initialize constant-velocity cubature filter.
<code>initcapf</code>	Initialize constant-acceleration particle filter.
<code>initctpf</code>	Initialize constant-turn-rate particle filter.
<code>initcvpf</code>	Initialize constant-velocity particle filter.
<code>initcvkf</code>	Initialize constant-velocity linear Kalman filter.
<code>initcvukf</code>	Initialize constant-velocity unscented Kalman filter.
<code>initcaekf</code>	Initialize constant-acceleration extended Kalman filter.
<code>initcakf</code>	Initialize constant-acceleration linear Kalman filter.

Initialization Function	Function Definition
<code>initcaukf</code>	Initialize constant-acceleration unscented Kalman filter.
<code>initctekf</code>	Initialize constant-turn-rate extended Kalman filter.
<code>initctukf</code>	Initialize constant-turn-rate unscented Kalman filter.
<code>initcvmscekf</code>	Initialize constant-velocity modified spherical coordinates extended Kalman filter.
<code>initrpekf</code>	Initialize constant-velocity range-parametrized extended Kalman filter.
<code>initapekf</code>	Initialize constant-velocity angle-parametrized extended Kalman filter.
<code>initekfimm</code>	Initialize tracking IMM filter.
<code>initsingerekf</code>	Initialize singer acceleration extended Kalman filter.

You can also write your own initialization function. The function must have the following syntax:

```
filter = filterInitializationFcn(detection)
```

The input to this function is a detection report like those created by `objectDetection`. The output of this function must be a filter object: `trackingKF`, `trackingEKF`, `trackingUKF`, `trackingCKF`, `trackingPF`, `trackingMSCEKF`, `trackingGSF`, `trackingIMM`, or `trackingABF`.

To guide you in writing this function, you can examine the details of the supplied functions from within MATLAB. For example:

```
type initcvekf
```

Data Types: `function_handle` | `char`

MaxNumTracks — Maximum number of tracks

100 (default) | positive integer

Maximum number of tracks that the tracker can maintain, specified as a positive integer.

Data Types: `single` | `double`

MaxNumSensors — Maximum number of sensors

20 (default) | positive integer

Maximum number of sensors that can be connected to the tracker, specified as a positive integer. `MaxNumSensors` must be greater than or equal to the largest value of `SensorIndex` found in all the detections used to update the tracker. `SensorIndex` is a property of an `objectDetection` object. The `MaxNumSensors` property determines how many sets of `ObjectAttributes` fields each output track can have.

Data Types: `single` | `double`

OOSMHandling — Handle out-of-sequence measurement (OOSM)

'Terminate' (default) | 'Neglect'

Handle out-of-sequence measurement (OOSM), specified as 'Terminate' or 'Neglect'. Each detection has a timestamp associated with it, t_d , and the tracker has its own timestamp, t_t , which is updated in each call. The tracker considers a measurement as an OOSM if $t_d < t_t$.

When the property is specified as

- 'Terminate' — The tracker stops running when it encounters any out-of-sequence measurements.
- 'Neglect' — The tracker neglects any out-of-sequence measurements and continue to run.

Tunable: Yes

StateParameters — Parameters of track state reference frame

struct([]) (default) | struct array

Parameters of the track state reference frame, specified as a structure or a structure array. The tracker passes its StateParameters property values to the StateParameters property of the generated tracks. You can use these parameters to define the reference frame in which the track is reported or other desirable attributes of the generated tracks.

For example, you can use the following structure to define a rectangular reference frame whose origin position is at [10 10 0] meters and whose origin velocity is [2 -2 0] meters per second with respect to the scenario frame.

Field Name	Value
Frame	"Rectangular"
Position	[10 10 0]
Velocity	[2 -2 0]

Tunable: Yes

Data Types: struct

MaxNumHypotheses — Maximum number of hypotheses to maintain

5 (default) | positive integer

Maximum number of hypotheses maintained by the tracks in cases of ambiguity, specified as a positive integer. Larger values increase the computational load.

Example: 10

Data Types: single | double

MaxNumTrackBranches — Maximum number of track branches per track

3 (default) | positive scalar

Set the maximum number of track branches (hypotheses) allowed for each track. Larger values increase the computational load.

Data Types: single | double

MaxNumHistoryScans — Maximum number of scans maintained in the branch history

4 (default) | positive integer

Maximum number of scans maintained in the branch history, specified as a positive integer. The number of track history scans is typically from 2 through 6. Larger values increase the computational load.

Example: 6

Data Types: `single` | `double`

AssignmentThreshold — Detection assignment threshold

30*[0.3 0.7 1 Inf] (default) | positive scalar | 1-by-3 vector of positive values | 1-by-4 vector of positive values

Detection assignment threshold, specified as a positive scalar, an 1-by-3 vector of non-decreasing positive values, $[C_1, C_2, C_3]$, or an 1-by-4 vector of non-decreasing positive values, $[C_1, C_2, C_3, C_4]$. If specified as a scalar, the specified value, *val*, will be expanded to $[0.3, 0.7, 1, \text{Inf}] * \text{val}$. If specified as $[C_1, C_2, C_3]$, it will be expanded as $[C_1, C_2, C_3, \text{Inf}]$.

The thresholds control (1) the assignment of a detection to a track, (2) the creation of a new branch from a detection, and (3) the creation of a new branch from an unassigned track. The threshold values must satisfy: $C_1 \leq C_2 \leq C_3 \leq C_4$.

- C_1 defines a distance such that if a track has an assigned detection with lower distance than C_1 , the track is no longer considered unassigned and does not create an unassigned track branch.
- C_2 defines a distance that if a detection has been assigned to a track with lower distance than C_2 , the detection is no longer considered unassigned and does not create a new track branch.
- C_3 defines the maximum distance for assigning a detection to a track.
- C_4 defines combinations of track and detection for which an accurate normalized cost calculation is performed. Initially, the tracker executes a coarse estimation for the normalized distance between all the tracks and detections. The tracker only calculates the accurate normalized distance for the combinations whose coarse normalized distance is less than C_4 .

Tips:

- Increase the value of C_3 if there are detections that should be assigned to tracks but are not. Decrease the value if there are detections that are assigned to tracks they should not be assigned to (too far away).
- Increasing the values C_1 and C_2 helps control the number of track branches that are created. However, doing so reduces the number of branches (hypotheses) each track has.
- Increase the value of C_4 if there are combinations of track and detection that should be calculated for assignment but are not. Decrease it if cost calculation takes too much time.

Data Types: `single` | `double`

ConfirmationThreshold — Minimum score required to confirm track

20 (default) | positive scalar

Minimum score required to confirm a track, specified as a positive scalar. Any track with a score higher than this threshold is confirmed.

Example: 12

Data Types: `single` | `double`

DeletionThreshold — Maximum score drop for track deletion

-7 (default) | scalar

The maximum score drop before a track is deleted, specified as a scalar. Any track with a score that falls by more than this parameter from the maximum score is deleted. Deletion threshold is affected by the probability of false alarm.

Example: 12

Data Types: `single` | `double`

DetectionProbability — Probability of detection used for track score

0.9 (default) | positive scalar between 0 and 1

Probability of detection, specified as a positive scalar between 0 and 1. This property is used to compute track score.

Example: 0.5

Data Types: `single` | `double`

FalseAlarmRate — Probability of false alarm used for track score

1e-6 (default) | scalar

The probability of false alarm, specified as a scalar. This property is used to compute track score.

Example: 1e-5

Data Types: `single` | `double`

Beta — Rate of new tracks per unit volume

1 (default) | positive scalar

The rate of new tracks per unit volume, specified as a positive scalar. The rate of new tracks is used in calculating the track score during track initialization.

Example: 2.5

Data Types: `single` | `double`

Volume — Volume of sensor measurement bin

1 (default) | positive scalar

The volume of a sensor measurement bin, specified as a positive scalar. For example, if a radar produces a 4-D measurement, which includes azimuth, elevation, range, and range rate, the 4-D volume is defined by the radar angular beam width, the range bin width and the range-rate bin width. Volume is used in calculating the track score when initializing and updating a track.

Example: 1.5

Data Types: `single` | `double`

MinBranchProbability — Minimum probability required to keep track

.001 (default) | positive scalar

Minimum probability required to keep a track, specified as a positive scalar less than one. Any track with lower probability is pruned. Typical values are 0.001 to 0.005.

Example: .003

Data Types: `single` | `double`

NScanPruning — N-scan pruning method

'None' (default) | 'Hypothesis'

N-scan pruning method, specified as 'None' or 'Hypothesis'. In N-scan pruning, branches that belong to the same track are pruned (deleted) if, in the N-scans history, they contradict the most likely branch for the same track. The most-likely branch is defined in one of two ways:

- 'None' - No N-scan pruning is performed.
- 'Hypothesis' - The chosen branch is in the most likely hypothesis.

Example: 'Hypothesis'

HasCostMatrixInput — Enable cost matrix input

false (default) | true

Enable a cost matrix, specified as false or true. If true, you can provide an assignment cost matrix as an input argument when calling the object.

Data Types: logical

HasDetectableBranchIDsInput — Enable input of detectable branch IDs

false (default) | true

Enable the input of detectable branch IDs at each object update, specified as false or true. Set this property to true if you want to provide a list of detectable branch IDs. This list tells the tracker of all branches that the sensors are expected to detect and, optionally, the probability of detection for each branch.

Data Types: logical

OutputRepresentation — Track output method

'Tracks' (default) | 'Hypothesis' | 'Clusters'

Track output method, specified as 'Tracks', 'Hypothesis', or 'Clusters'.

- 'Tracks' - Output the centroid of each track based on its track branches.
- 'Hypothesis' - Output branches that are in certain hypotheses. If you choose this option, list the hypotheses to output using the HypothesesToOutput property.
- 'Clusters' - Output the centroid of each cluster. Similar to 'Tracks' output, but includes all tracks within a cluster.

Data Types: char

HypothesesToOutput — Indices of hypotheses to output

1 (default) | positive integer | array of positive integers

Indices of hypotheses to output, specified as an array of positive integers. The indices must all be less than or equal to the maximum number of hypotheses provided by the tracker.

Tunable: Yes

Data Types: single | double

NumTracks — Number of tracks maintained by tracker

nonnegative integer

This property is read-only.

Number of tracks maintained by the tracker, returned as a nonnegative integer.

Data Types: double

NumConfirmedTracks — Number of confirmed tracks

nonnegative integer

This property is read-only.

Number of confirmed tracks, returned as a nonnegative integer. If the `IsConfirmed` field of an output track structure is `true`, the track is confirmed.

Data Types: double

Usage

To process detections and update tracks, call the tracker with arguments, as if it were a function (described here).

Syntax

```
confirmedTracks = tracker(detections,time)
confirmedTracks = tracker(detections,time,costMatrix)
confirmedTracks = tracker(___,detectableBranchIDs)
[confirmedTracks,tentativeTracks,allTracks] = tracker(___)
[confirmedTracks,tentativeTracks,allTracks,analysisInformation] = tracker(___)
)
```

Description

`confirmedTracks = tracker(detections,time)` returns a list of confirmed tracks that are updated from a list of detections, `detections`, at the update time, `time`. Confirmed tracks are corrected and predicted to the update time.

`confirmedTracks = tracker(detections,time,costMatrix)` also specifies a cost matrix, `costMatrix`.

To enable this syntax, set the `HasCostMatrixInput` property to `true`.

`confirmedTracks = tracker(___,detectableBranchIDs)` also specifies a list of expected detectable branches, `detectableBranchIDs`.

To enable this syntax, set the `HasDetectableBranchIDsInput` property to `true`.

`[confirmedTracks,tentativeTracks,allTracks] = tracker(___)` also returns a list of tentative tracks, `tentativeTracks`, and a list of all tracks, `allTracks`.

`[confirmedTracks,tentativeTracks,allTracks,analysisInformation] = tracker(___)` also returns information, `analysisInformation`, useful for track analysis.

Input Arguments**detections — Detection list**

cell array of `objectDetection` objects

Detection list, specified as a cell array of `objectDetection` objects. The `Time` property value of each `objectDetection` object must be less than or equal to the current update time, `time`, and

greater than the previous time value used to update the tracker. Also, the Time differences between different objectDetection objects in the cell array do not need to be equal.

time — Time of update

scalar

Time of update, specified as a scalar. The tracker updates all tracks to this time. Units are in seconds.

time must be greater than or equal to the largest Time property value of the objectDetection objects in the input detections list. time must increase in value with each update to the tracker.

Data Types: single | double

costMatrix — Cost matrix

real-valued N -by- M matrix

Cost matrix, specified as a real-valued N -by- M matrix, where N is the number of branches, and M is the number of current detections. The cost matrix rows must be in the same order as the list of branches. The columns must be in the same order as the list of detections. Obtain the correct order of the list of branches using the getBranches object function. Matrix columns correspond to the detections.

At the first update of the object or when the tracker has no previous tracks, specify the cost matrix to have a size of $[0, \text{numDetections}]$. Note that the cost must be calculated so that lower costs indicate a higher likelihood of assigning a detection to a track. To prevent certain detections from being assigned to certain tracks, set the appropriate cost matrix entry to Inf.

Dependencies

To enable this argument, set the HasCostMatrixInput property to true.

Data Types: double | single

detectableBranchIDs — Detectable branch IDs

real-valued M -by-1 vector | real-valued M -by-2 matrix

Detectable branch IDs, specified as a real-valued M -by-1 vector or M -by-2 matrix. Detectable branches are branches that the sensors expect to detect. The first column of the matrix contains a list of branch IDs of tracks reported in the branchID field of the track output arguments. The second column contains the detection probability for the branch. Sensors can report detection probability, but if not reported, detection probabilities are obtained from the DetectionProbability property.

Branches whose identifiers are not included in detectableBranchIDs are considered as undetectable. The track deletion logic does not count the lack of detection as a 'miss' for branch deletion purposes.

Dependencies

To enable this input argument, set the HasDetectableBranchIDs property to true.

Data Types: single | double

Output Arguments

confirmedTracks — Confirmed tracks

array of objectTrack objects | array of structures

Confirmed tracks, returned as an array of `objectTrack` objects in MATLAB, and returned as an array of structures in code generation. In code generation, the field names of the returned structure are same with the property names of `objectTrack`.

A track is confirmed if it satisfies the confirmation threshold specified in the `ConfirmationThreshold` property. In that case, the `IsConfirmed` property of the object or field of the structure is `true`.

Data Types: `struct` | `object`

tentativeTracks – Tentative tracks

array of `objectTrack` objects | array of structures

Tentative tracks, returned as an array of `objectTrack` objects in MATLAB, and returned as an array of structures in code generation. In code generation, the field names of the returned structure are same with the property names of `objectTrack`.

A track is tentative if it does not satisfy the confirmation threshold specified in the `ConfirmationThreshold` property. In that case, the `IsConfirmed` property of the object or field of the structure is `false`.

Data Types: `struct` | `object`

allTracks – All tracks

array of `objectTrack` objects | array of structures

All tracks, returned as an array of `objectTrack` objects in MATLAB, and returned as an array of structures in code generation. In code generation, the field names of the returned structure are same with the property names of `objectTrack`. All tracks consists of confirmed and tentative tracks.

Data Types: `struct` | `object`

analysisInformation – Additional information for analyzing track updates

structure

Additional information for analyzing track updates, returned as a structure. The fields of this structure are:

Field	Description
<code>BranchIDsAtStepBeginning</code>	Branch IDs when update began.
<code>CostMatrix</code>	Cost of assignment matrix.
<code>Assignments</code>	Assignments returned from <code>assignTOMHT</code> .
<code>UnassignedTracks</code>	IDs of unassigned branches returned from the tracker
<code>UnassignedDetections</code>	Indices of unassigned detections in the <code>detections</code> input.
<code>InitialBranchHistory</code>	Branch history after branching and before pruning.
<code>InitialBranchScores</code>	Branch scores before pruning.
<code>KeptBranchHistory</code>	Branch history after initial pruning.
<code>KeptBranchScores</code>	Branch scores after initial pruning.

Clusters	Logical array mapping branches to clusters. Branches belong in the same cluster if they share detections in their history or belong to the same track, either directly or through other branches. Such branches are incompatible.
TrackIncompatibility	Branch incompatibility matrix. The (i, j) element is true if the i -th and j -th branches have shared detections in their history or belong to the same track.
GlobalHypotheses	Logical matrix mapping branches to global hypotheses. Compatible branches can belong in the same hypotheses.
GlobalHypScores	Total score of global hypotheses.
PrunedBranches	Logical array of branches that the <code>pruneTrackBranches</code> function determines to be pruned.
GlobalBranchProbabilities	Global probability of each branch existing in the global hypotheses.
BranchesDeletedByPruning	Branches deleted by the tracker.
BranchIDsAtStepEnd	Branch IDs when the update ended.

Data Types: `struct`

Object Functions

To use an object function, specify the System object as the first input argument. For example, to release system resources of a System object named `obj`, use this syntax:

```
release(obj)
```

Specific to trackerTOMHT

<code>getTrackFilterProperties</code>	Obtain track filter properties
<code>setTrackFilterProperties</code>	Set track filter properties
<code>getBranches</code>	Lists track branches
<code>predictTrackToTime</code>	Predict track state
<code>initializeTrack</code>	Initialize new track
<code>deleteTrack</code>	Delete existing track
<code>initializeBranch</code>	Initialize new track branch
<code>deleteBranch</code>	Delete existing track branch

Common to All System Objects

<code>release</code>	Release resources and allow changes to System object property values and input characteristics
<code>reset</code>	Reset internal states of System object
<code>isLocked</code>	Determine if System object is in use
<code>clone</code>	Create duplicate System object

Examples

Track Two Objects Using trackerTOMHT

Create the trackerTOMHT System object with a constant-velocity Kalman filter initialization function, `initcvkf`.

```
tracker = trackerTOMHT('FilterInitializationFcn',@initcvkf, ...
    'ConfirmationThreshold',20, ...
    'DeletionThreshold',-7, ...
    'MaxNumHypotheses',10);
```

Update the tracker with two detections having nonzero `ObjectClassID`. The detections immediately create confirmed tracks.

```
detections = {objectDetection(1,[10;0],'SensorIndex',1, ...
    'ObjectClassID',5,'ObjectAttributes',{struct('ID',1)}); ...
    objectDetection(1,[0;10],'SensorIndex',1, ...
    'ObjectClassID',2,'ObjectAttributes',{struct('ID',2)}});
time = 2;
tracks = tracker(detections,time);
```

Find and display the positions and velocities.

```
positionSelector = [1 0 0 0; 0 0 1 0];
velocitySelector = [0 1 0 0; 0 0 0 1];
positions = getTrackPositions(tracks,positionSelector)
```

positions = 2×2

```
    10.0000     0
         0    10.0000
```

```
velocities = getTrackVelocities(tracks,velocitySelector)
```

velocities = 2×2

```
     0     0
     0     0
```

Algorithms

Tracker Logic Flow

When you process detections using the tracker, track creation and management follow these steps.

- 1 The tracker attempts to assign detections to existing tracks.
- 2 The track allows for multiple hypotheses about the assignment of detections to tracks.
- 3 Unassigned detections result in the creation of new tracks.
- 4 Assignments of detections to tracks create branches for the assigned tracks.
- 5 Tracks with no assigned detections are coasted (predicted).

- 6 All track branches are scored. Branches with low initial scores are pruned.
- 7 Clusters of branches that share detections (incompatible branches) in their history are generated.
- 8 Global hypotheses of compatible branches are formulated and scored.
- 9 Branches are scored based on their existence in the global hypotheses. Low-scored branches are pruned.
- 10 Additional pruning is performed based on N-scan history.
- 11 All tracks are corrected and predicted to the input time.

Assignment Thresholds for Multi-Hypothesis Tracker

Three assignment thresholds, C_1 , C_2 , and C_3 , control (1) the assignment of a detection to a track, (2) the creation of a new branch from a detection, and (3) the creation of a new branch from an unassigned track. The threshold values must satisfy: $C_1 \leq C_2 \leq C_3$.

If the cost of an assignment is $C = \text{costmatrix}(i, j)$, the following hypotheses are created based on comparing the cost to the values of the assignment thresholds. Below each comparison, there is a list of the possible hypotheses.

- Track
- Detection

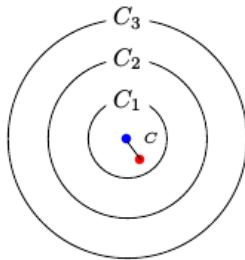

$$C \leq C_1$$

Single Hypothesis

- (1) Detection is assigned to track. A branch is created updating the track with this detection.

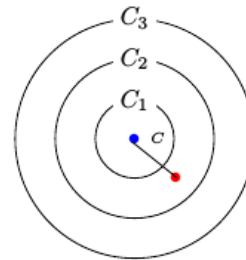

$$C_1 < C \leq C_2$$

Two Hypotheses

- (1) Detection is assigned to track. A branch is created updating the track with this detection.
- (2) Track is not assigned to detection and is coasted.

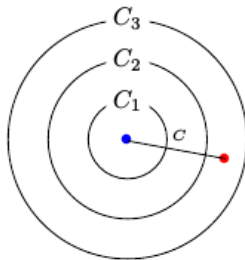

$$C_2 < C \leq C_3$$

Three Hypotheses

- (1) Detection is assigned to track. A branch is created updating the track with this detection.
- (2) Track is not assigned to detection and is coasted.
- (3) Detection is not assigned and creates a new track (branch).

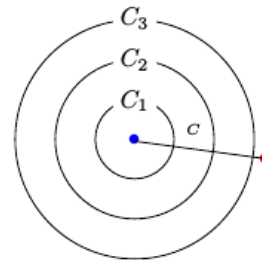

$$C_3 < C$$

Single Hypothesis

- (1) Detection is not assigned and creates a new track (branch).

Tips:

- Increase the value of C_3 if there are detections that should be assigned to tracks but are not. Decrease the value if there are detections that are assigned to tracks they should not be assigned to (too far away).
- Increasing the values C_1 and C_2 helps control the number of track branches that are created. However, doing so reduces the number of branches (hypotheses) each track has.
- To allow each track to be unassigned, set $C_1 = 0$.
- To allow each detection to be unassigned, set $C_2 = 0$.

Data Precision

All numeric inputs can be single or double precision, but they all must have the same precision.

References

- [1] Werthmann, J. R.. "Step-by-Step Description of a Computationally Efficient Version of Multiple Hypothesis Tracking." In *International Society for Optics and Photonics*, Vol. 1698, pp. 228-301, 1992.
- [2] Blackman, S., and R. Popoli. *Design and Analysis of Modern Tracking Systems*. Artech House Radar Library, Boston, 1999.

Extended Capabilities

C/C++ Code Generation

Generate C and C++ code using MATLAB® Coder™.

Usage notes and limitations:

- See "System Objects in MATLAB Code Generation" (MATLAB Coder).
- All the detections used with a multi-object tracker must have properties with the same sizes and types.
- If you use the `ObjectAttributes` field within an `objectDetection` object, you must specify this field as a cell containing a structure. The structure for all detections must have the same fields and the values in these fields must always have the same size and type. The form of the structure cannot change during simulation.
- If `ObjectAttributes` are contained in the detection, the `SensorIndex` value of the detection cannot be greater than 10.
- The first update to the multi-object tracker must contain at least one detection.

See Also

Functions

`getTrackPositions` | `getTrackVelocities`

Objects

`fusionRadarSensor` | `irSensor` | `objectDetection` | `objectTrack` | `sonarSensor` | `trackerGNN` | `trackingABF` | `trackingCKF` | `trackingEKF` | `trackingGSF` | `trackingIMM` | `trackingKF` | `trackingMSCEKF` | `trackingPF` | `trackingUKF`

Introduced in R2018b

deleteBranch

Delete existing track branch

Syntax

```
deleted = deleteTrack(tracker,branchID)
```

Description

`deleted = deleteTrack(tracker,branchID)` deletes the track branch specified by `branchID` in the tracker.

Input Arguments

tracker — TOMHT tracker

`trackerTOMHT` object

TOMHT tracker, specified as a `trackerTOMHT` object.

branchID — Track branch identifier

positive integer

Track branch identifier, specified as a positive integer.

Example: 21

Output Arguments

deleted — Indicate if track branch was successfully deleted

`true` | `false`

Indicate if the track branch was successfully deleted or not, returned as `true` or `false`. If the track branch specified by the `branchID` input existed and was successfully deleted, it returns as `true`. If the track branch did not exist, a warning is issued and it returns as `false`.

Extended Capabilities

C/C++ Code Generation

Generate C and C++ code using MATLAB® Coder™.

See Also

`trackFuser` | `trackerGNN` | `trackerJPDA` | `trackerTOMHT`

Introduced in R2020a

initializeBranch

Initialize new track branch

Syntax

```
branchID = initializeTrack(tracker,branch)
branchID = initializeTrack(tracker,branch,filter)
```

Description

`branchID = initializeTrack(tracker,branch)` initializes a new track branch in the tracker. The tracker must be updated at least once before initializing a track branch. If the track is initialized successfully, the tracker assigns the output `branchID` to the branch, set the `UpdateTime` of the branch equal to the last step time, and synchronizes the data in the input branch to the initialized branch.

A warning is issued if the tracker already maintains the maximum number of track branches specified by the `MaxNumTrackBranches` property of the tracker. In this case, the `branchID` is returned as zero, which indicates a failure to initialize the branch.

Note This syntax doesn't support using the `trackingGSF`, `trackingPF`, or `trackingIMM` filter object as the internal tracking filter for the tracker. Use the second syntax for these cases.

`branchID = initializeTrack(tracker,branch,filter)` initializes a new track branch in the tracker using a specified tracking filter, `filter`.

Note If the tracking filter used in the tracker is `trackingGSF`, `trackingPF`, or `trackingIMM`, you must use this syntax instead of the first syntax.

Input Arguments

tracker — TOMHT tracker

`trackerTOMHT` object

TOMHT tracker, specified a `trackerTOMHT` object.

branch — New track branch to be initialized

`objectTrack` | structure

New track to be initialized, specified as an `objectTrack` object or a structure. If specified as a structure, the name, variable type, and data size of the fields of the structure must be the same as the name, variable type, and data size of the corresponding properties of the `objectTrack` object outputted by the tracker.

Data Types: `struct` | `object`

filter — Filter object

trackingKF | trackingEKF | trackingUKF | trackingABF | trackingCKF | trackingMSCEKF | trackingPF | trackingIMM | trackingGSF

Filter object, specified as a trackingKF, trackingEKF, trackingUKF, trackingABF, trackingCKF, trackingIMM, trackingGSF, trackingPF, or trackingMSCEKF object.

Output Arguments

branchID — Track branch identifier

nonnegative integer

Track identifier, returned as a nonnegative integer. trackID is returned as 0 if the branch is not initialized successfully.

Example: 2

See Also

trackerTOMHT

Introduced in R2020a

getTrackFilterProperties

Obtain track filter properties

Syntax

```
filtervalues = getTrackFilterProperties(tracker,branchID,properties)
filtervalues = getTrackFilterProperties(tracker,trackID,properties)
```

Description

`filtervalues = getTrackFilterProperties(tracker,branchID,properties)` returns the values, `filtervalues`, of tracking filter properties, `properties`, for the specified branch, `branchID`.

This syntax applies when you create the tracker using `trackerTOMHT`.

`filtervalues = getTrackFilterProperties(tracker,trackID,properties)` returns the values, `filtervalues`, of tracking filter properties, `properties`, for the specified track, `trackID`.

This syntax applies when you create the tracker using `trackerGNN` or `trackerJPDA`.

Examples

Get Multi-Hypothesis Track Filter Properties

Create a track filter with default properties from one detection. Obtain the values of the `MeasurementNoise` and `ProcessNoise` track filter properties.

```
tracker = trackerTOMHT;
detection = objectDetection(0,[0;0;0]);
tracker(detection,0);
branches = getBranches(tracker);
branchID = branches(1).BranchID;
values = getTrackFilterProperties(tracker, branchID, ...
    'MeasurementNoise', 'ProcessNoise')
```

```
values=2×1 cell array
    {3×3 double}
    {3×3 double}
```

```
disp(values{1})
```

```
1    0    0
0    1    0
0    0    1
```

Get Global Nearest-Neighbor Track Filter Properties

Create a track filter from one detection. Assume default properties. Obtain the values of the MeasurementNoise and ProcessNoise track filter properties.

```
tracker = trackerGNN;  
detection = objectDetection(0,[0;0;0]);  
[~,tracks] = tracker(detection,0);  
values = getTrackFilterProperties(tracker,tracks.TrackID, ...  
    'MeasurementNoise','ProcessNoise')
```

```
values=2x1 cell array  
    {3x3 double}  
    {3x3 double}
```

```
disp(values{1})
```

```
    1    0    0  
    0    1    0  
    0    0    1
```

Input Arguments

tracker — Target tracker

trackerTOMHT object | trackerGNN object

Target tracker, specified as a trackerTOMHT or trackerGNN object.

branchID — Branch identifier

positive integer

Branch identifier, specified as a positive integer. The identifier must be a valid BranchID reported in the list of branches returned by the getBranches object function.

Example: 21

Dependencies

Data Types: uint32

trackID — Track identifier

positive integer

Track identifier, specified as a positive integer. trackID must be a valid track identifier as reported from the previous track update.

Example: 21

Data Types: uint32

properties — Filter properties

comma-delimited list of properties

Filter properties, specified as a comma-delimited list of valid tracker properties to obtain. Enclose each property in single quotes.

Example: 'MeasurementNoise','ProcessNoise'

Data Types: char

Output Arguments

filtervalues — Filter property values

cell array

Filter property values, returned as a cell array. Filter values are returned in the same order as the list of properties.

Introduced in R2018b

setTrackFilterProperties

Set track filter properties

Syntax

```
setTrackFilterProperties(tracker,branchID,'Name',Value)
setTrackFilterProperties(tracker,trackID,'Name',Value)
```

Description

`setTrackFilterProperties(tracker,branchID,'Name',Value)` sets the values of tracking filter properties of the tracker, `tracker`, for the branch specified by, `branchID`. Use valid Name-Value pairs to set properties for the branch. You can specify as many Name-Value pairs as you wish. Property names must match the names of public filter properties. This syntax applies when you create the tracker using `trackerTOMHT`.

`setTrackFilterProperties(tracker,trackID,'Name',Value)` sets the values of tracking filter properties of the tracker, `tracker`, for the track, `trackID`. Use Name-Value pairs to set properties for the track. You can specify as many Name-Value pairs as you wish. Property names must match the names of public filter properties. This syntax applies when you create the tracker using `trackerGNN` or `trackerJPDA`.

Examples

Set Multi-Hypothesis Tracking Filter Properties

Create a tracker using `trackerTOMHT`. Assign values to the `MeasurementNoise` and `ProcessNoise` properties and verify the assignment.

```
tracker = trackerTOMHT;
detection = objectDetection(0,[0;0;0]);
tracker(detection,0);
branches = getBranches(tracker);
branchID = branches(1).BranchID;
setTrackFilterProperties(tracker,branchID,'MeasurementNoise',2,'ProcessNoise',5);
values = getTrackFilterProperties(tracker,branchID,'MeasurementNoise','ProcessNoise');
```

Show the measurement noise.

```
disp(values{1})

    2.0000         0         0
         0    2.0000         0
         0         0    2.0000
```

Show the process noise.

```
disp(values{2})
```

```

5.0000    0    0
   0    5.0000    0
   0    0    5.0000

```

Set Global Nearest-Neighbor Track Filter Properties

Create a tracker using `trackerGNN`. Assign values to the `MeasurementNoise` and `ProcessNoise` properties and verify the assignment.

```

tracker = trackerGNN;
detection = objectDetection(0,[0;0;0]);
[~, tracks] = tracker(detection,0);
setTrackFilterProperties(tracker,1,'MeasurementNoise',2,'ProcessNoise',5);
values = getTrackFilterProperties(tracker,1,'MeasurementNoise','ProcessNoise');

```

Show the measurement noise.

```

disp(values{1})

2.0000    0    0
   0    2.0000    0
   0    0    2.0000

```

Show the process noise.

```

disp(values{2})

5.0000    0    0
   0    5.0000    0
   0    0    5.0000

```

Input Arguments

tracker — Target tracker

`trackerTOMHT` object | `trackerGNN` object

Target tracker, specified as a `trackerTOMHT` or `trackerGNN` object.

branchID — Branch identifier

positive integer

Branch identifier, specified as a positive integer. The identifier must be a valid `BranchID` reported in the list of branches returned by the `getBranches` object function.

Example: 21

Data Types: `uint32`

trackID — Track identifier

positive integer

Track identifier, specified as a positive integer. `trackID` must be a valid track identifier as reported from the previous track update.

Example: 21

Data Types: uint32

Introduced in R2018b

getBranches

Lists track branches

Syntax

```
branches = getBranches(tracker)
```

Description

`branches = getBranches(tracker)` returns a list of track branches maintained by the tracker. The tracker must be updated at least once before calling this object function. Use `isLocked(tracker)` to test whether the tracker has been updated.

Examples

Get Multi-Hypothesis Tracker Branches

Create a multi-hypothesis tracker with one detection and obtain its branches.

```
tracker = trackerTOMHT;
detection = objectDetection(0, [0;0;0]);
tracker(detection,0);
branches = getBranches(tracker)
```

```
branches =
  objectTrack with properties:
      TrackID: 1
      BranchID: 1
      SourceIndex: 0
      UpdateTime: 0
      Age: 1
      State: [6x1 double]
      StateCovariance: [6x6 double]
      StateParameters: [1x1 struct]
      ObjectClassID: 0
      TrackLogic: 'Score'
      TrackLogicState: [13.7102 13.7102]
      IsConfirmed: 0
      IsCoasted: 0
      IsSelfReported: 1
      ObjectAttributes: [1x1 struct]
```

Input Arguments

tracker — Target tracker

trackerTOMHT object | trackerGNN object

Target tracker, specified as a `trackerTOMHT` or `trackerGNN` object.

Output Arguments

branches — List of track branches

structure | array of structures

List of track branches, returned as an array of track structure or array of track structures.

Field	Description
TrackID	Integer that identifies the track.
BranchID	Unique integer that identifies the track branch (hypothesis).
UpdateTime	Time to which the track is updated.
Age	Number of times the track was updated with either a hit or a miss.
State	Value of state vector at update time.
StateCovariance	Uncertainty covariance matrix.
TrackLogic	The track logic used. Values are either 'History' or 'Score'.
TrackLogicState	The current state of the track logic. <ul style="list-style-type: none"> For 'History' track logic, a 1-by-Q logical array, where Q is the greater of N or R from the confirmation and deletion thresholds. For 'Score' track logic, a 1-by-2 numerical array in the form: [currentScore, maxScore].
IsConfirmed	True if the track is assumed to be of a real target.
IsCoasted	True if the track has been updated without a detection (predicted).
ObjectClassID	An integer value representing the object classification. Zero is reserved for 'unknown'.
ObjectAttributes	A cell array of cells. Each cell captures the object attributes reported by the corresponding sensor.

Data Types: struct

Introduced in R2018b

predictTracksToTime

Predict track state

Syntax

```

predictedtracks = predictTracksToTime(obj, trackid, time)
predictedtracks = predictTracksToTime(obj, category, time)
predictedtracks = predictTracksToTime(obj, type, id, time)
predictedtracks = predictTracksToTime(obj, type, category, time)
predictedtracks = predictTracksToTime( ____, 'WithCovariance', tf)

```

Description

`predictedtracks = predictTracksToTime(obj, trackid, time)` returns the predicted tracks, `predictedtracks`, of the tracker or fuser object, `obj`, at the specified time, `time`. Specify the track identifier, `trackid`. The tracker or fuser must be updated at least once before calling this object function. Use `isLocked(obj)` to test whether the tracker or fuser has been updated.

This syntax applies when you create the `obj` using `trackerGNN`, `trackerJPDA`, `trackerPHD`, `trackerGridRFS`, or `trackFuser`.

Note This function only outputs the predicted tracks and does not update the internal track states of the tracker or fuser.

`predictedtracks = predictTracksToTime(obj, category, time)` returns all predicted tracks for a specified category, `category`, of tracked objects.

This syntax applies when you create the `obj` using `trackerGNN`, `trackerJPDA`, `trackerPHD`, `trackerGridRFS`, or `trackFuser`.

`predictedtracks = predictTracksToTime(obj, type, id, time)` returns the predicted tracks or branches, `predictedtracks`, of the tracker or fuser object, `obj`, at the specified time, `time`. Specify the type, `type`, of tracked object and the object ID, `id`. The tracker or fuser must be updated at least once before calling this object function. Use `isLocked(trackObj)` to test whether the tracker or fuser has been updated.

This syntax applies when you create the `obj` using `trackerTOMHT`.

`predictedtracks = predictTracksToTime(obj, type, category, time)` returns all predicted tracks or branches for a specified category, `category`, of tracked objects.

This syntax applies when you create the `obj` using `trackerTOMHT`.

`predictedtracks = predictTracksToTime(____, 'WithCovariance', tf)` also allows you to specify whether to predict the state covariance of each track or not by setting the `tf` flag to `true` or `false`. Predicting the covariance slows down the prediction process and increases the computation cost, but it provides the predicted track state covariance in addition to the predicted state. The default is `false`.

Examples

Predict Track State

Create a track from a detection and predict its state later on.

```
tracker = trackerTOMHT;
detection = objectDetection(0,[0;0;0]);
tracker(detection,0);
branches = getBranches(tracker);
predictedtracks = predictTracksToTime(tracker, 'branch',1,1)
```

```
predictedtracks =
  objectTrack with properties:

    TrackID: 1
    BranchID: 1
    SourceIndex: 0
    UpdateTime: 1
    Age: 1
    State: [6x1 double]
    StateCovariance: [6x6 double]
    StateParameters: [1x1 struct]
    ObjectClassID: 0
    TrackLogic: 'Score'
    TrackLogicState: [13.7102 13.7102]
    IsConfirmed: 0
    IsCoasted: 0
    IsSelfReported: 1
    ObjectAttributes: [1x1 struct]
```

Input Arguments

obj — Tacker or fuser object

trackerTOMHT object | trackerJPDA object | trackerGNN object | trackerGridRFS object | trackerFuser object

Tracker or fuser object, specified as a trackerTOMHT, trackerJPDA object, trackerGNN object, trackerGridRFS object, or trackFuser object.

type — Tracked object type

'track' | 'branch'

Tracked object type, specified as 'track' or 'branch'.

id — Track or branch identifier

positive integer

Track or branch identifier, specified as a positive integer.

Example: 21

Data Types: single | double

trackid — Track identifier

positive integer

Track identifier, specified as a positive integer.

Example: 15

Data Types: single | double

time — Prediction time

scalar

Prediction time, specified as a scalar. The states of tracks are predicted to this time. The time must be greater than the time input to the tracker in the previous track update. Units are in seconds.

Example: 1.0

Data Types: single | double

category — Track categories

'all' | 'confirmed' | 'tentative'

Track categories, specified as 'all', 'confirmed', or 'tentative'. You can choose to predict all tracks, only confirmed tracks, or only tentative tracks.

Data Types: char

Output Arguments**predictedtracks — List of predicted track or branch states**

array of objectTrack objects | array of structures

List of tracks or branches, returned as an array of structures or an array of objectTrack objects. If the obj input is specified as a trackerGNN, trackerJPDA, or trackFuser object, it is returned as an array of objectTrack objects in MATLAB, and returned as an array of structures with field names same as the property names of objectTrack in code generation. If the obj input is specified as a trackerPHD object, it is returned as an array of structures, in which each structure contains the following fields:

Field	Description
TrackID	Unique integer that identifies the track.
SourceIndex	Unique identifier the tracker in a multiple tracker environment. The SourceIndex is exactly the same with the TrackerIndex.
UpdateTime	The time the track was updated.
Age	Number of times the track survived.
State	Value of state vector at the update time.
StateCovariance	Uncertainty covariance matrix.

Extent	Spatial extent estimate of the tracked object, returned as a d -by- d matrix, where d is the dimension of the object. This field is only returned when the tracking filter is specified as a <code>ggiwphd</code> filter.
MeasurementRate	Expected number of detections from the tracked object. This field is only returned when the tracking filter is specified as a <code>ggiwphd</code> filter.
IsConfirmed	True if the track is assumed to be of a real target.
IsCoasted	<code>trackerPHD</code> does not support the <code>IsCoasted</code> field. The value is always 0.
ObjectClassID	<code>trackerPHD</code> does not support the <code>ObjectClassID</code> field. The value is always 0.
StateParameters	Parameters about the track state reference frame specified in the <code>StateParameters</code> property of the PHD tracker.
IsSelfReported	Indicate if the track is reported by the tracker. This field is used in a track fusion environment. It is returned as <code>true</code> by default.

Data Types: `struct` | `object`

Introduced in R2018b

trackerGNN

Multi-sensor, multi-object tracker using GNN assignment

Description

The `trackerGNN` System object is a tracker capable of processing detections of many targets from multiple sensors. The tracker uses a global nearest-neighbor (GNN) assignment algorithm. The tracker initializes, confirms, predicts, corrects, and deletes tracks. Inputs to the tracker are detection reports generated by `objectDetection`, `fusionRadarSensor`, `irSensor`, or `sonarSensor` objects. The tracker estimates the state vector and state vector covariance matrix for each track. Each detection is assigned to at most one track. If the detection cannot be assigned to any track, the tracker initializes a new track.

Any new track starts in a *tentative* state. If enough detections are assigned to a tentative track, its status changes to *confirmed*. If the detection already has a known classification (the `ObjectClassID` field of the returned track is nonzero), that track is confirmed immediately. When a track is confirmed, the tracker considers the track to represent a physical object. If detections are not assigned to the track within a specifiable number of updates, the track is deleted.

To track objects using this object:

- 1 Create the `trackerGNN` object and set its properties.
- 2 Call the object with arguments, as if it were a function.

To learn more about how System objects work, see [What Are System Objects?](#).

Creation

Syntax

```
tracker = trackerGNN
tracker = trackerGNN(Name,Value)
```

Description

`tracker = trackerGNN` creates a `trackerGNN` System object with default property values.

`tracker = trackerGNN(Name,Value)` sets properties for the tracker using one or more name-value pairs. For example, `trackerGNN('FilterInitializationFcn',@initcvkf,'MaxNumTracks',100)` creates a multi-object tracker that uses a constant-velocity, unscented Kalman filter and allows a maximum of 100 tracks. Enclose each property name in quotes.

Properties

Unless otherwise indicated, properties are *nontunable*, which means you cannot change their values after calling the object. Objects lock when you call them, and the `release` function unlocks them.

If a property is *tunable*, you can change its value at any time.

For more information on changing property values, see System Design in MATLAB Using System Objects.

TrackerIndex — Unique tracker identifier

0 (default) | nonnegative integer

Unique tracker identifier, specified as a nonnegative integer. This property is used as the `SourceIndex` in the tracker outputs, and distinguishes tracks that come from different trackers in a multiple-tracker system. You must specify this property as a positive integer to use the track outputs as inputs to a track fuser.

Example: 1

FilterInitializationFcn — Filter initialization function

@initcvckf (default) | function handle | character vector

Filter initialization function, specified as a function handle or as a character vector containing the name of a filter initialization function. The tracker uses a filter initialization function when creating new tracks.

Sensor Fusion and Tracking Toolbox supplies many initialization functions that you can use to specify `FilterInitializationFcn`.

Initialization Function	Function Definition
<code>initcvabf</code>	Initialize constant-velocity alpha-beta filter
<code>initcaabf</code>	Initialize constant-acceleration alpha-beta filter
<code>initcvekf</code>	Initialize constant-velocity extended Kalman filter.
<code>initcackf</code>	Initialize constant-acceleration cubature filter.
<code>initctckf</code>	Initialize constant-turn-rate cubature filter.
<code>initcvckf</code>	Initialize constant-velocity cubature filter.
<code>initcapf</code>	Initialize constant-acceleration particle filter.
<code>initctpf</code>	Initialize constant-turn-rate particle filter.
<code>initcvpf</code>	Initialize constant-velocity particle filter.
<code>initcvkf</code>	Initialize constant-velocity linear Kalman filter.
<code>initcvukf</code>	Initialize constant-velocity unscented Kalman filter.
<code>initcaekf</code>	Initialize constant-acceleration extended Kalman filter.
<code>initcakf</code>	Initialize constant-acceleration linear Kalman filter.
<code>initcaukf</code>	Initialize constant-acceleration unscented Kalman filter.
<code>initctekf</code>	Initialize constant-turn-rate extended Kalman filter.

Initialization Function	Function Definition
<code>initctukf</code>	Initialize constant-turn-rate unscented Kalman filter.
<code>initcvmscekf</code>	Initialize constant-velocity modified spherical coordinates extended Kalman filter.
<code>initrpekf</code>	Initialize constant-velocity range-parametrized extended Kalman filter.
<code>initapekf</code>	Initialize constant-velocity angle-parametrized extended Kalman filter.
<code>initekfimm</code>	Initialize tracking IMM filter.
<code>initsingerekf</code>	Initialize singer acceleration extended Kalman filter.

You can also write your own initialization function. The function must have the following syntax:

```
filter = filterInitializationFcn(detection)
```

The input to this function is a detection report like those created by `objectDetection`. The output of this function must be a filter object: `trackingKF`, `trackingEKF`, `trackingUKF`, `trackingCKF`, `trackingPF`, `trackingMSCEKF`, `trackingGSF`, `trackingIMM`, or `trackingABF`.

To guide you in writing this function, you can examine the details of the supplied functions from within MATLAB. For example:

```
type initcvekf
```

Data Types: `function_handle` | `char`

Assignment — Assignment algorithm

`'MatchPairs'` (default) | `'Munkres'` | `'Jonker-Volgenant'` | `'Auction'` | `'Custom'`

Assignment algorithm, specified as `'MatchPairs'`, `'Munkres'`, `'Jonker-Volgenant'`, `'Auction'`, or `'Custom'`. Munkres is the only assignment algorithm that guarantees an optimal solution, but it is also the slowest, especially for large numbers of detections and tracks. The other algorithms do not guarantee an optimal solution but can be faster for problems with 20 or more tracks and detections. Use `'Custom'` to define your own assignment function and specify its name in the `CustomAssignmentFcn` property.

Example: `'Custom'`

Data Types: `char`

CustomAssignmentFcn — Custom assignment function

character vector

Custom assignment function name, specified as a character string. An assignment function must have the following syntax:

```
[assignment, unTrs, unDets] = f(cost, costNonAssignment)
```

For an example of an assignment function and a description of its arguments, see `assignmunkres`.

Dependencies

To enable this property, set the `Assignment` property to 'Custom'.

Data Types: `char`

AssignmentThreshold — Detection assignment threshold

`30*[1 Inf]` (default) | positive scalar | 1-by-2 vector of positive values

Detection assignment threshold (or gating threshold), specified as a positive scalar or an 1-by-2 vector of $[C_1, C_2]$, where $C_1 \leq C_2$. If specified as a scalar, the specified value, *val*, will be expanded to $[val, Inf]$.

Initially, the tracker executes a *coarse* estimation for the normalized distance between all the tracks and detections. The tracker only calculates the *accurate* normalized distance for the combinations whose *coarse* normalized distance is less than C_2 . Also, the tracker can only assign a detection to a track if their *accurate* normalized distance is less than C_1 . See the `distance` function used with tracking filters (for example, `trackingCKF` and `trackingEKF`) for an explanation of the distance calculation.

Tips:

- Increase the value of C_2 if there are combinations of track and detection that should be calculated for assignment but are not. Decrease it if cost calculation takes too much time.
- Increase the value of C_1 if there are detections that should be assigned to tracks but are not. Decrease it if there are detections that are assigned to tracks they should not be assigned to (too far away).

TrackLogic — Confirmation and deletion logic type

'History' (default) | 'Score'

Confirmation and deletion logic type, specified as 'History' or 'Score'.

- 'History' - Track confirmation and deletion is based on the number of times the track has been assigned to a detection in the latest tracker updates.
- 'Score' - Track confirmation and deletion is based on a log-likelihood track score. A high score means that the track is more likely to be valid. A low score means that the track is more likely to be a false alarm.

ConfirmationThreshold — Threshold for track confirmation

scalar | 1-by-2 vector

Threshold for track confirmation, specified as a scalar or a 1-by-2 vector. The threshold depends on the type of track confirmation and deletion logic you set using the `TrackLogic` property.

- History - Specify the confirmation threshold as 1-by-2 vector $[M N]$. A track is confirmed if it receives at least *M* detections in the last *N* updates. The default value is $[2, 3]$.
- Score - Specify the confirmation threshold as a scalar. A track is confirmed if its score is at least as high as the confirmation threshold. The default value is 20.

Data Types: `single` | `double`

DeletionThreshold — Minimum score required to delete track

$[5 5]$ or -7 (default) | scalar | real-valued 1-by-2 vector of positive values

Minimum score required to delete track, specified as a scalar or a real-valued 1-by-2 vector. The threshold depends on the type of track confirmation and deletion logic you set using the `TrackLogic` property:

- **History** - Specify the confirmation threshold as [P R]. If a confirmed track is not assigned to any detection P times in the last R tracker updates, then the track is deleted.
- **Score** - A track is deleted if its score decreases by at least the threshold from the maximum track score.

Example: 3

Data Types: `single` | `double`

DetectionProbability — Probability of detection used for track score

0.9 (default) | positive scalar between 0 and 1

Probability of detection, specified as a positive scalar between 0 and 1. This property is used to compute track score.

Example: 0.5

Data Types: `single` | `double`

FalseAlarmRate — Probability of false alarm used for track score

1e-6 (default) | scalar

The probability of false alarm, specified as a scalar. This property is used to compute track score.

Example: 1e-5

Data Types: `single` | `double`

Beta — Rate of new tracks per unit volume

1 (default) | positive scalar

The rate of new tracks per unit volume, specified as a positive scalar. The rate of new tracks is used in calculating the track score during track initialization.

Example: 2.5

Data Types: `single` | `double`

Volume — Volume of sensor measurement bin

1 (default) | positive scalar

The volume of a sensor measurement bin, specified as a positive scalar. For example, if a radar produces a 4-D measurement, which includes azimuth, elevation, range, and range rate, the 4-D volume is defined by the radar angular beam width, the range bin width and the range-rate bin width. Volume is used in calculating the track score when initializing and updating a track.

Example: 1.5

Data Types: `single` | `double`

MaxNumTracks — Maximum number of tracks

100 (default) | positive integer

Maximum number of tracks that the tracker can maintain, specified as a positive integer.

Data Types: `single` | `double`

MaxNumSensors — Maximum number of sensors

20 (default) | positive integer

Maximum number of sensors that can be connected to the tracker, specified as a positive integer. `MaxNumSensors` must be greater than or equal to the largest value of `SensorIndex` found in all the detections used to update the tracker. `SensorIndex` is a property of an `ObjectDetection` object. The `MaxNumSensors` property determines how many sets of `ObjectAttributes` fields each output track can have.

Data Types: `single` | `double`

OOSMHandling — Handle out-of-sequence measurement (OOSM)

'Terminate' (default) | 'Neglect'

Handle out-of-sequence measurement (OOSM), specified as 'Terminate' or 'Neglect'. Each detection has a timestamp associated with it, t_d , and the tracker has its own timestamp, t_t , which is updated in each call. The tracker considers a measurement as an OOSM if $t_d < t_t$.

When the property is specified as

- 'Terminate' — The tracker stops running when it encounters any out-of-sequence measurements.
- 'Neglect' — The tracker neglects any out-of-sequence measurements and continue to run.

Tunable: Yes

StateParameters — Parameters of track state reference frame

`struct([])` (default) | `struct` array

Parameters of the track state reference frame, specified as a structure or a structure array. The tracker passes its `StateParameters` property values to the `StateParameters` property of the generated tracks. You can use these parameters to define the reference frame in which the track is reported or other desirable attributes of the generated tracks.

For example, you can use the following structure to define a rectangular reference frame whose origin position is at [10 10 0] meters and whose origin velocity is [2 -2 0] meters per second with respect to the scenario frame.

Field Name	Value
Frame	"Rectangular"
Position	[10 10 0]
Velocity	[2 -2 0]

Tunable: Yes

Data Types: `struct`

HasDetectableTrackIDsInput — Enable input of detectable track IDs

false (default) | true

Enable the input of detectable track IDs at each object update, specified as `false` or `true`. Set this property to `true` if you want to provide a list of detectable track IDs. This list tells the tracker of all

tracks that the sensors are expected to detect and, optionally, the probability of detection for each track.

Data Types: `logical`

HasCostMatrixInput — Enable cost matrix input

`false` (default) | `true`

Enable a cost matrix, specified as `false` or `true`. If `true`, you can provide an assignment cost matrix as an input argument when calling the object.

Data Types: `logical`

NumTracks — Number of tracks maintained by tracker

nonnegative integer

This property is read-only.

Number of tracks maintained by the tracker, returned as a nonnegative integer.

Data Types: `double`

NumConfirmedTracks — Number of confirmed tracks

nonnegative integer

This property is read-only.

Number of confirmed tracks, returned as a nonnegative integer. If the `IsConfirmed` field of an output track structure is `true`, the track is confirmed.

Data Types: `double`

Usage

To process detections and update tracks, call the tracker with arguments, as if it were a function (described here).

Syntax

```
confirmedTracks = tracker(detections,time)
confirmedTracks = tracker(detections,time,costMatrix)
confirmedTracks = tracker(___,detectableTrackIDs)
[confirmedTracks,tentativeTracks,allTracks] = tracker(___)
[confirmedTracks,tentativeTracks,allTracks,analysisInformation] = tracker(___)
)
```

Description

`confirmedTracks = tracker(detections,time)` returns a list of confirmed tracks that are updated from a list of detections, `detections`, at the update time, `time`. Confirmed tracks are corrected and predicted to the update time.

`confirmedTracks = tracker(detections,time,costMatrix)` also specifies a cost matrix, `costMatrix`.

To enable this syntax, set the `HasCostMatrixInput` property to `true`.

`confirmedTracks = tracker(____, detectableTrackIDs)` also specifies a list of expected detectable tracks, `detectableTrackIDs`.

To enable this syntax, set the `HasDetectableTrackIDsInput` property to `true`.

`[confirmedTracks, tentativeTracks, allTracks] = tracker(____)` also returns a list of tentative tracks, `tentativeTracks`, and a list of all tracks, `allTracks`.

`[confirmedTracks, tentativeTracks, allTracks, analysisInformation] = tracker(____)` also returns information, `analysisInformation`, which can be used for track analysis.

Input Arguments

detections — Detection list

cell array of `objectDetection` objects

Detection list, specified as a cell array of `objectDetection` objects. The `Time` property value of each `objectDetection` object must be less than or equal to the current update time, `time`, and greater than the previous time value used to update the tracker. Also, the `Time` differences between different `objectDetection` objects in the cell array do not need to be equal.

time — Time of update

scalar

Time of update, specified as a scalar. The tracker updates all tracks to this time. Units are in seconds.

`time` must be greater than or equal to the largest `Time` property value of the `objectDetection` objects in the input `detections` list. `time` must increase in value with each update to the tracker.

Data Types: `single` | `double`

costMatrix — Cost matrix

real-valued N -by- M matrix

Cost matrix, specified as a real-valued N -by- M matrix, where N is the number of existing tracks, and M is the number of current detections. The cost matrix rows must be in the same order as the list of tracks. The columns must be in the same order as the list of detections. Obtain the correct order of the list of tracks from the third output argument, `allTracks`, when the tracker is updated.

At the first update of the object or when the tracker has no previous tracks, specify the cost matrix to have a size of `[0, numDetections]`. Note that the cost must be calculated so that lower costs indicate a higher likelihood of assigning a detection to a track. To prevent certain detections from being assigned to certain tracks, set the appropriate cost matrix entry to `Inf`.

Dependencies

To enable this argument, set the `HasCostMatrixInput` property to `true`.

Data Types: `double` | `single`

detectableTrackIDs — Detectable track IDs

real-valued M -by-1 vector | real-valued M -by-2 matrix

Detectable track IDs, specified as a real-valued M -by-1 vector or M -by-2 matrix. Detectable tracks are tracks that the sensors expect to detect. The first column of the matrix contains a list of track IDs that the sensors report as detectable. The second column contains the detection probability for the track.

The detection probability is either reported by a sensor or, if not reported, obtained from the `DetectionProbability` property.

Tracks whose identifiers are not included in `detectableTrackIDs` are considered as undetectable. The track deletion logic does not count the lack of detection as a 'missed detection' for track deletion purposes.

Dependencies

To enable this input argument, set the `detectableTrackIDs` property to `true`.

Data Types: `single` | `double`

Output Arguments

confirmedTracks — Confirmed tracks

array of `objectTrack` objects | array of structures

Confirmed tracks, returned as an array of `objectTrack` objects in MATLAB, and returned as an array of structures in code generation. In code generation, the field names of the returned structure are same with the property names of `objectTrack`.

A track is confirmed if it satisfies the confirmation threshold specified in the `ConfirmationThreshold` property. In that case, the `IsConfirmed` property of the object or field of the structure is `true`.

Data Types: `struct` | `object`

tentativeTracks — Tentative tracks

array of `objectTrack` objects | array of structures

Tentative tracks, returned as an array of `objectTrack` objects in MATLAB, and returned as an array of structures in code generation. In code generation, the field names of the returned structure are same with the property names of `objectTrack`.

A track is tentative if it does not satisfy the confirmation threshold specified in the `ConfirmationThreshold` property. In that case, the `IsConfirmed` property of the object or field of the structure is `false`.

Data Types: `struct` | `object`

allTracks — All tracks

array of `objectTrack` objects | array of structures

All tracks, returned as an array of `objectTrack` objects in MATLAB, and returned as an array of structures in code generation. In code generation, the field names of the returned structure are same with the property names of `objectTrack`. All tracks consists of confirmed and tentative tracks.

Data Types: `struct` | `object`

analysisInformation — Additional information for analyzing track updates

structure

Additional information for analyzing track updates, returned as a structure. The fields of this structure are:

Field	Description
TrackIDsAtStepBeginning	Track IDs when step began
CostMatrix	Cost of assignment matrix
Assignments	Assignments returned from the assignment function.
UnassignedTracks	IDs of unassigned tracks returned from the tracker
UnassignedDetections	Indices of unassigned detections in the detections input.
InitiatedTrackIDs	IDs of tracks initiated during the step
DeletedTrackIDs	IDs of tracks deleted during the step
TrackIDsAtStepEnd	Track IDs when the step ended

Data Types: struct

Object Functions

To use an object function, specify the System object as the first input argument. For example, to release system resources of a System object named `obj`, use this syntax:

```
release(obj)
```

Specific to trackerGNN

<code>getTrackFilterProperties</code>	Obtain track filter properties
<code>setTrackFilterProperties</code>	Set track filter properties
<code>predictTrackToTime</code>	Predict track state
<code>initializeTrack</code>	Initialize new track
<code>deleteTrack</code>	Delete existing track

Common to All System Objects

<code>release</code>	Release resources and allow changes to System object property values and input characteristics
<code>reset</code>	Reset internal states of System object
<code>isLocked</code>	Determine if System object is in use
<code>clone</code>	Create duplicate System object

Examples

Track Two Objects Using trackerGNN

Construct a `trackerGNN` object with the default 2-D constant-velocity Kalman filter initialization function, `initcvkf`.

```
tracker = trackerGNN('FilterInitializationFcn', @initcvkf, ...
    'ConfirmationThreshold', [4 5], ...
    'DeletionThreshold', 10);
```

Update the tracker with two detections both having nonzero `ObjectClassID`. These detections immediately create confirmed tracks.

```
detections = {objectDetection(1,[10;0], 'SensorIndex',1, ...
    'ObjectClassID',5, 'ObjectAttributes',{struct('ID',1)}); ...
    objectDetection(1,[0;10], 'SensorIndex',1, ...
    'ObjectClassID',2, 'ObjectAttributes',{struct('ID',2)});
time = 2;
tracks = tracker(detections,time);
```

Find the positions and velocities.

```
positionSelector = [1 0 0 0; 0 0 1 0];
velocitySelector = [0 1 0 0; 0 0 0 1];

positions = getTrackPositions(tracks,positionSelector)

positions = 2×2

    10     0
     0    10

velocities = getTrackVelocities(tracks,velocitySelector)

velocities = 2×2

     0     0
     0     0
```

Algorithms

Tracker Logic Flow

When a GNN tracker processes detections, track creation and management follow these steps.

- 1 The tracker divides detections by originating sensor.
- 2 For each sensor:
 - a The tracker calculates the distances from detections to existing tracks and forms a `costMatrix`.
 - b Based on the costs, the tracker performs global nearest neighbor assignment using the algorithm specified in the `Assignment` property.
 - c The assignment algorithm divides the detections and tracks into three groups:
 - Assigned one-to-one detection and track pairs
 - Unassigned detections
 - Unassigned tracks
- 3 Unassigned detections initialize new tracks. Using the unassigned detection, the tracker initializes a new track filter specified by the `FilterInitializationFcn` property. The track logic for the new track is initialized as well.

The tracker checks if any of the unassigned detections from other sensors can be assigned to the new track. If so, the tracker updates the new track with the assigned detections from the other sensors. As a result, these detections no longer initialize new tracks.

- 4 The pairs of assigned tracks and detections are used to update each track. The track filter is updated using the `correct` method provided by the specified tracking filter. Also, the track logic is updated with a 'hit'. The tracker checks if the track meets the criteria for confirmation. If so, the tracker confirms the track and sets the `IsCoasted` property to `false`.
- 5 Unassigned tracks are updated with a 'miss' and their `IsCoasted` flag is set to `true`. The tracker checks if the track meets the criteria for deletion. If so, the tracker removes the track from the maintained track list.
- 6 All tracks are predicted to the latest time value (either the time input if provided, or the latest mean cluster time stamp).

References

- [1] Blackman, S., and R. Popoli. *Design and Analysis of Modern Tracking Systems*. Artech House Radar Library, Boston, 1999.

Extended Capabilities

C/C++ Code Generation

Generate C and C++ code using MATLAB® Coder™.

Usage notes and limitations:

- See “System Objects in MATLAB Code Generation” (MATLAB Coder).
- All the detections used with a multi-object tracker must have properties with the same sizes and types.
- If you use the `ObjectAttributes` field within an `objectDetection` object, you must specify this field as a cell containing a structure. The structure for all detections must have the same fields, and the values in these fields must always have the same size and type. The form of the structure cannot change during simulation.
- If `ObjectAttributes` are contained in the detection, the `SensorIndex` value of the detection cannot be greater than 10.
- The first update to the multi-object tracker must contain at least one detection.

See Also

Functions

`assignTOMHT` | `assignauction` | `assignjv` | `assignkbest` | `assignkbestsd` | `assignmunkres` | `assignsd` | `clusterTrackBranches` | `compatibleTrackBranches` | `fusecovint` | `fusecovunion` | `fusexcov` | `getTrackPositions` | `getTrackVelocities` | `pruneTrackBranches` | `triangulateLOS`

Objects

`objectDetection` | `objectTrack` | `staticDetectionFuser` | `trackHistoryLogic` | `trackScoreLogic` | `trackerJPDA` | `trackerTOMHT` | `trackingABF` | `trackingCKF` | `trackingEKF` | `trackingGSF` | `trackingIMM` | `trackingKF` | `trackingMSCEKF` | `trackingPF` | `trackingUKF`

Topics

“Introduction to Multiple Target Tracking”

“Introduction to Assignment Methods in Tracking Systems”

Introduced in R2018b

trackerGridRFS

Grid-based multi-object tracker

Description

The `trackerGridRFS` System object is a tracker capable of processing detections of multiple targets from multiple sensors in a 2-D environment. The tracker tracks dynamic objects around an autonomous system using high resolution sensor data such as point clouds and radar detections. The tracker uses the random finite set (RFS) based approach combined with Dempster-Shafer approximations defined in [1] to estimate the dynamic characteristics of the grid cells. To extract objects from the grid, the tracker uses a cell-to-track association scheme [2]. For more details, see “Algorithms” on page 3-505.

To track targets using this object:

- 1 Create the `trackerGridRFS` object and set its properties.
- 2 Call the object with arguments, as if it were a function.

To learn more about how System objects work, see [What Are System Objects?](#).

Creation

Syntax

```
tracker = trackerGridRFS  
tracker = trackerGridRFS(Name,Value)
```

Description

`tracker = trackerGridRFS` creates a `trackerGridRFS` System object with default property values.

`tracker = trackerGridRFS(Name,Value)` sets properties for the tracker using one or more name-value pairs. For example, `trackerGridRFS('MaxNumTracks',100)` creates a grid-based multi-object tracker that allows a maximum of 100 tracks. Enclose each property name in quotes.

Properties

Unless otherwise indicated, properties are *nontunable*, which means you cannot change their values after calling the object. Objects lock when you call them, and the `release` function unlocks them.

If a property is *tunable*, you can change its value at any time.

For more information on changing property values, see [System Design in MATLAB Using System Objects](#).

Tracker Configuration

TrackerIndex — Unique tracker identifier

0 (default) | nonnegative integer

Unique tracker identifier, specified as a nonnegative integer. This property is used as the `SourceIndex` in the tracker outputs, and distinguishes tracks that come from different trackers in a multiple-tracker system. You must specify this property as a positive integer to use the track outputs as inputs to a track fuser.

Example: 1

SensorConfigurations — Configurations of tracking sensors

cell array of `trackingSensorConfiguration` objects

Configuration of tracking sensors, specified as a cell array of `trackingSensorConfiguration` objects. This property provides the tracking sensor configuration information, such as sensor detection limits, sensor resolution, and sensor mounting, to the tracker. There are no default values for the `SensorConfigurations` property, and you must specify the `SensorConfigurations` property before using the tracker. You can update the configuration, if the `HasSensorConfigurationsInput` property is set to `true`, by specifying the configuration input argument `configs`.

When specifying the `trackingSensorConfiguration` object, the following properties must be specified with these formats:

Property Name	Format
<code>SensorIndex</code>	Unique identifier of the sensor, specified as a positive integer.
<code>IsValidTime</code>	Indicate if the sensor data should be used to update tracks, specified as <code>true</code> or <code>false</code> .
<code>SensorTransformParameters</code>	Parameters of sensor transform function, specified as a p -element array of measurement parameter structures. p is the number of sensors. The structure should contain fields with the same names as the measurement parameters used in a measurement function, such as the <code>cvmeas</code> function. The first structure must describe the transformation from the autonomous system to the sensor coordinates. The subsequent structure describes the transformation from the autonomous system to the tracking coordinate frame. If only one structure is provided, the tracker assumes tracking is performed in the coordinate frame of the autonomous system.
<code>SensorLimits</code>	Sensor detection limits, specified as a 2-by-2 matrix of scalars. The first row specifies the lower and upper limits of the azimuth angle in degrees. The second row specifies the lower and upper limits of the detection range in meters.

The tracker ignores the `FilterInitializationFcn`, `SensorTransformFcn`, and `MaxNumDetsPerObject` properties of the `trackingSensorConfiguration` object.

HasSensorConfigurationsInput — Enable updating sensor configurations with time

`false` (default) | `true`

Enable updating sensor configurations with time, specified as `false` or `true`. Set this property to `true` if you want the configurations of the sensors updated with time. When this property is set to `true`, you must specify the configuration input `configs` when using this object.

Data Types: `logical`

StateParameters — Parameters of track state reference frame

`struct([])` (default) | `struct array`

Parameters of the track state reference frame, specified as a structure or a structure array. The tracker passes its `StateParameters` property values to the `StateParameters` property of the generated tracks. You can use these parameters to define the reference frame in which the track is reported or other desirable attributes of the generated tracks.

For example, you can use the following structure to define a rectangular reference frame whose origin position is at `[10 10 0]` meters and whose origin velocity is `[2 -2 0]` meters per second with respect to the scenario frame.

Field Name	Value
Frame	"Rectangular"
Position	[10 10 0]
Velocity	[2 -2 0]

Tunable: Yes

Data Types: `struct`

MaxNumSensors — Maximum number of sensors

20 (default) | positive integer

Maximum number of sensors that can be connected to the tracker, specified as a positive integer. `MaxNumSensors` must be greater than or equal to the largest value of `SensorIndex` found in all the sensor data and configurations used to update the tracker.

Data Types: `single` | `double`

MaxNumTracks — Maximum number of tracks

100 (default) | positive integer

Maximum number of tracks that the tracker can maintain, specified as a positive integer.

Data Types: `single` | `double`

Grid Definition

GridLength — x-direction dimension of grid

100 (default) | positive scalar

x-direction dimension of the grid in the local coordinates, specified as a positive scalar in meters.

GridWidth — y-direction dimension of grid

100 (default) | positive scalar

y-direction dimension of the grid in the local coordinates, specified as a positive scalar in meters.

GridResolution — Resolution of grid

1 (default) | positive scalar

Resolution of the grid, specified as a positive scalar. `GridResolution` represents the number of cells per meter of the grid for both the x- and y-direction of the grid.

GridOriginInLocal — Location of grid origin in local coordinate frame

[-50 -50] (default) | two-element vector of scalar

Location of the grid origin in the local coordinate frame, specified as a two-element vector of scalars in meters. The grid origin represents the bottom-left corner of the grid.

Particle Filtering

MotionModel — Motion model for tracking

'constant-velocity' (default) | 'constant-acceleration' | 'constant-turn-rate'

Motion model for tracking, specified as 'constant-velocity', 'constant-acceleration', or 'constant-turn-rate'. The particle state and object state for each motion model are:

MotionModel	Particle State	Object State
'constant-velocity'	[x; vx; y; vy]	[x; vx; y; vy; yaw; L; W]
'constant-acceleration'	[x; vx; ax; y; vy; ay]	[x; vx; ax; y; vy; ay; yaw; L; W]
'constant-turn-rate'	[x; vx; y; vy; w]	[x; vx; y; vy; w; yaw; L; W]

where:

- x — Position of the object in the x direction of the local tracking frame (m)
- y — Position of the object in the y direction of the local tracking frame (m)
- vx — Velocity of the object in the x direction of the local tracking frame (m/s)
- vy — Velocity of the object in the y direction of the local tracking frame (m/s)
- ax — Acceleration of the object in the x direction of the local tracking frame (m/s²)
- ay — Acceleration of the object in the y direction of the local tracking frame (m/s²)
- w — Yaw-rate of the object in the local tracking frame (degree/s)
- yaw — Yaw angle of the object in the local tracking frame (deg)
- L — Length of the object (m)
- W — Width of the object (m)

VelocityLimits — Minimum and maximum velocity of objects

[-10 10; -10 10] (default) | 2-by-2 matrix of scalar

Minimum and maximum velocity of objects, specified as a 2-by-2 matrix of scalars in m/s. The first row specifies the lower and upper velocity limits in the x-direction and the second row specifies the

lower and upper velocity limits in the y-direction. The tracker uses these limits to sample new particles in the grid using a uniform distribution.

AccelerationLimits — Minimum and maximum acceleration of objects

`[-5 5; -5 5]` (default) | 2-by-2 matrix of scalar

Minimum and maximum acceleration of objects, specified as a 2-by-2 matrix of scalars in m/s². The first row specifies the lower and upper acceleration limits in the x-direction and the second row specifies the lower and upper acceleration limits in the y-direction. The tracker uses these limits to sample new particles in the grid using a uniform distribution.

This property is only active when the `MotionModel` property is set to `'constant-acceleration'`.

TurnrateLimits — Minimum and maximum turn rate of objects

`[-5; 5]` (default) | two-element vector of scalar

Minimum and maximum turn rate of objects, specified a two-element vector of scalars in degree/s. The first element defines the minimum turn rate and the second element defines the maximum turn-rate.

This property is only active when the `MotionModel` property is set to `'constant-turnrate'`.

ProcessNoise — Process noise covariance

N-by-*N* identity matrix (default) | *N*-by-*N* matrix of scalar

Process noise covariance, specified as an *N*-by-*N* matrix of scalars. This property specifies the process noise for positions of particles and the geometric centers of targets.

- When the `HasAdditiveProcessNoise` property is set to `true`, the process directly adds to the prediction model. In this case, *N* is equal to the dimension of the particle state.
- When the `HasAdditiveProcessNoise` property is set to `false`, define the process noise according to the selected motion model. The process noise is added to the higher order terms, such as the acceleration for the `'constant-acceleration'` model.

MotionModel	Number of Terms (N)	Meaning of Terms
<code>'constant-velocity'</code>	2	Acceleration in the x and y directions
<code>'constant-acceleration'</code>	2	Jerk in the x and y directions
<code>'constant-turn-rate'</code>	3	Acceleration in the x and y directions as well as the angular acceleration

Example: `[1.0 0.05; 0.05 2]`

Tunable: Yes

HasAdditiveProcessNoise — Enable to model process noise as additive

`false` (default) | `true`

Enable to model process noise as additive, specified as `true` or `false`. When this property is `true`, process noise is added directly to the state vector. Otherwise, noise is incorporated in the motion model.

Example: `true`

NumParticles – Number of particles per grid

10000 (default) | positive integer

Number of particles per grid, specified as a positive integer. A higher number of particles can improve estimation quality, but can increase computational cost.

NumBirthParticles – Number of newborn particles per time step

1000 (default) | positive scalar

Number of newborn (initialized) particles per time step, specified as a positive integer. The tracker determines the locations of these new-born particles by using the mismatch between the predicted and the updated occupancy belief masses and the BirthProbability property. A reasonable value of the NumBirthParticles property is approximately ten percent of the number of particles specified by the NumParticles property.

BirthProbability – Probability of target birth in a cell per step

0.01 (default) | scalar in [0 1)

Probability of target birth in a cell per step, specified as a scalar in the range [0 1). The birth probability controls the probability that new particles are generated in a cell.

Example: 1e-4

DeathRate – Death rate of particles per unit time

1e-3 (default) | positive scalar

Death rate of particles per unit time, specified as a positive scalar. Death rate indicates the possibility that a particle or target vanishes after one time step. Death rate influences the survival probability (P_s) of a component between successive time steps as:

$$P_s = (1 - P_d)^{\Delta T}$$

where ΔT is the time step.

Example: 1e-4

Tunable: Yes

FreeSpaceDiscountFactor – Confidence in free space prediction

0.8 (default) | scalar

Confidence in free space prediction, specified as a scalar. In the prediction stage of the tracker, the belief mass of a cell to be in the "free" (unoccupied) state is reduced by the FreeSpaceDiscountFactor:

$$m_k | k - 1(F) = \alpha^{\Delta T} m_{k - 1}(F)$$

where k is the time step index, m is the belief mass, α is the free space discount factor, and ΔT is the time step.

Tunable: Yes

Track Initialization

Clustering – Clustering method used for new object extraction

'DBSCAN' (default) | 'Custom'

Clustering method used for new object extraction, specified as 'DBSCAN' or 'Custom'.

- 'DBSCAN' — Cluster unassigned dynamic grid cells using the density-based spatial clustering of applications with noise (DBSCAN) algorithm. You can configure the DBSCAN algorithm by specifying the `ClusteringThreshold` and `MinNumCellsPerCluster` properties of the tracker.
- 'Custom' — Cluster unassigned dynamic grid cells using a custom clustering function specified in the `CustomClusteringFcn` property of the tracker.

ClusteringThreshold – Threshold for DBSCAN clustering

5 (default) | positive scalar

Threshold for DBSCAN clustering, specified as a positive scalar.

To enable this property, set the `Clustering` property to 'DBSCAN'.

CustomClusteringFcn – Custom function for clustering unassigned grid cells

function handle

Custom function for clustering unassigned grid cells, specified as a function handle. The function must support this signature:

```
function indices = myFunction(dynamicGridCells)
```

where `dynamicGridCells` is a structure defining a set of grid cells initializing the track. It must have these fields:

Field	Description
Width	Width of the cell, specified as a positive scalar.
GridIndices	Indices of the grid cells, specified as an N -by-2 array, where N is the number of unassigned cells. The first element specifies the grid index in the x -direction and the second element specifies the grid index in the y -direction.
State	States of the grid cells, specified as a P -by- N array of scalars, where P is the dimension of the state and N is the number of unassigned cells.

Field	Description
StateCovariance	State covariances of the grid cells, specified as a P -by- P -by- N array of scalars, where P is the dimension of the state and N is the number of unassigned cells.
OccupancyMass	Occupancy belief mass of the cells, specified as an N -element array of scalars, where N is the number of unassigned cells.
FreeMass	Free belief mass of the cells, specified as an N -element array of scalars, where N is the number of unassigned cells.

`indices` must be returned as an N -element vector of indices defining the cluster index for each dynamic grid cell.

To enable this property, set the `Clustering` property to 'Custom'.

MinNumCellsPerCluster – Minimum number of cells per cluster for DBSCAN

2 (default) | positive integer

Minimum number of cells per cluster for DBSCAN, specified as a positive scalar. This property affects whether a point is a core point in the DBSCAN algorithm.

To enable this property, set the `Clustering` property to 'DBSCAN'.

TrackInitializationFcn – Function to initialize new track

'trackerGridRFS.defaultTrackInitialization' (default) | function handle

Function to initialize new tracks, specified as a function handle. The initialization function initiates a track from a set of dynamic grid cells.

The default initialization function merges the Gaussian estimate from each cell to describe the state of the object. The orientation of the object is aligned with the direction of its mean velocity. With a defined orientation, the length and width of the object are extracted using the geometric properties of the cells. The object calculates uncertainties in length, width, and orientation estimates are calculated using linear approximations.

If you choose to customize your own initialization function, the function must support the following signature:

```
function track = myFunction(dynamicGridCells)
```

where `dynamicGridCells` is a structure defining a set of grid cells initializing the track. It has the following fields:

Field	Description
Width	Width of the cell, specified as a positive scalar.

Field	Description
GridIndices	Indices of the grid cells, specified as an N -by-2 array, where N is the number of unassigned cells. The first element specifies the grid index in the x -direction and the second element specifies the grid index in the y -direction.
State	States of the grid cells, specified as a P -by- N array of scalars, where P is the dimension of the state and N is the number of unassigned cells.
StateCovariance	State covariances of the grid cells, specified as a P -by- P -by- N array of scalars, where P is the dimension of the state and N is the number of unassigned cells.
OccupancyMass	Occupancy belief mass of the cells, specified as an N -element array of scalars, where N is the number of unassigned cells.
FreeMass	Free belief mass of the cells, specified as an N -element array of scalars, where N is the number of unassigned cells.

track must be returned as an objectTrack object or a structure whose field names are the same as the property names of an objectTrack object. The dimension of the state must be the same as the state dimension specified in the MotionModel property.

Track Management

TrackUpdateFcn — Function to update existing track

'trackerGridRFS.defaultTrackUpdate' (default) | function handle

Function to update an existing track using its associated set of dynamic grid cells, specified as a function handle.

The default update function updates the State and StateCovariance properties of the track using the new estimate from the dynamic grid cells associated with the track. The update process is similar to the initialization process for the TrackInitializationFcn property. The tracker does not apply filtering to the state and state covariance.

If you choose to customize your own update function, the function must support this signature:

```
function updatedTrack = TrackUpdateFcn(predictedTrack,dynamicGridCells)
```

where:

- predictedTrack is the predicted track of an object, specified as an objectTrack object.
- dynamicGridCells is a structure defining a set of dynamic grid cells associated to the track. The structure has these fields:

Field	Description
Width	Width of the cell, specified as a positive scalar.

Field	Description
GridIndices	Indices of the grid cells, specified as an N -by-2 array, where N is the number of unassigned cells. The first element specifies the grid index in the x -direction and the second element specifies the grid index in the y -direction.
State	States of the grid cells, specified as a P -by- N array of scalars, where P is the dimension of the state and N is the number of unassigned cells.
StateCovariance	State covariances of the grid cells, specified as a P -by- P -by- N array of scalars, where P is the dimension of the state and N is the number of unassigned cells.
OccupancyMass	Occupancy belief mass of the cells, specified as an N -element array of scalars, where N is the number of unassigned cells.
FreeMass	Free belief mass of the cells, specified as an N -element array of scalars, where N is the number of unassigned cells.

- `updatedTrack` is the updated track, returned as an `objectTrack` object or a structure whose field names are the same as the property names of an `objectTrack` object.

AssignmentThreshold – Threshold for assigning dynamic grid cells to tracks

30 (default) | positive scalar

Threshold for assigning dynamic grid cells to tracks, specified as a positive scalar. A dynamic grid cell can only be associated to a track if its distance (represented by the negative log-likelihood) to the track is less than the `AssignmentThreshold` value.

- Increase the threshold if a dynamic cell is not being assigned to a track that it should be assigned to.
- Decrease the threshold if there are dynamic cells being assigned to a track that they should be not assigned to.

Example: 18.1

ConfirmationThreshold – Threshold for track confirmation

[2 3] (default) | 2-element vector of scalar

Threshold for track confirmation, specified as a 2-element vector of scalars [M N]. A track is confirmed if it has been assigned to any dynamic grid cell in at least M updates of the last N updates.

DeletionThreshold – Threshold for track deletion

[5 5] (default) | 2-element vector of scalar

Threshold for track deletion, specified as a 2-element vector of scalars [P R]. A track is deleted if has not been assigned to any dynamic grid cell in at least P updates of the last R updates.

Example: 0.01

Data Types: single | double

NumTracks — Number of tracks maintained by tracker

nonnegative integer

This property is read-only.

Number of tracks maintained by the tracker, returned as a nonnegative integer.

Data Types: double

NumConfirmedTracks — Number of confirmed tracks

nonnegative integer

This property is read-only.

Number of confirmed tracks, returned as a nonnegative integer. If the `IsConfirmed` property of an output track object is `true`, the track is confirmed.

Data Types: double

UseGPU — Enable using GPU for estimation of dynamic grid map`false` (default) | `true`

This property is read-only.

Enable using GPU for estimation of the dynamic grid map, specified as `true` or `false`. Enabling GPU computation requires the Parallel Computing Toolbox.

Usage

Syntax

```
confirmedTracks = tracker(sensorData,time)
confirmedTracks = tracker(sensorData,configs,time)
[confirmedTracks,tentativeTracks,allTracks] = tracker( ___ )
[confirmedTracks,tentativeTracks,allTracks,map] = tracker( ___ )
```

Description

`confirmedTracks = tracker(sensorData,time)` returns a list of confirmed tracks that are updated from a list of sensor data `sensorData` at the update time `time`. Confirmed tracks are corrected and predicted to the update time.

`confirmedTracks = tracker(sensorData,configs,time)` also specifies the configurations of sensors `configs`. To enable this syntax, set the `HasSensorConfigurationsInput` property to `true`.

`[confirmedTracks,tentativeTracks,allTracks] = tracker(___)` also returns a list of tentative tracks `tentativeTracks` and a list of all tracks `allTracks`. You can use any combination of input arguments from previous syntaxes.

`[confirmedTracks,tentativeTracks,allTracks,map] = tracker(___)` additionally returns the evidential grid map maintained in the tracker. You can use the returned map to obtain details on the estimates.

Input Arguments

sensorData — Sensor data

N-element array of structure

Sensor data, specified as an *N*-element array of structures. Each structure must define the measurement from a high resolution sensor using the these fields:

Fields	Description
Time	Time at which the sensor reports the data, specified as a nonnegative scalar.
SensorIndex	Unique identifier of the sensor, specified as a positive integer.
Measurement	Measurements of the sensor, specified a <i>K</i> -by- <i>M</i> matrix of scalars. <i>K</i> is the dimension of measurements, and <i>M</i> is the number of measurements. Each measurement defines the positional aspects of the detection in a rectangular or spherical frame.
MeasurementParameters	Measurement parameters, specified as a structure describing the transformation from the particle state to measurement. See “Object Detections” on page 3-304 for more details.

The `Time` value must be less than or equal to the current update time, `time`, and greater than the previous time value used to update the tracker.

time — Time of update

scalar

Time of update, specified as a scalar. The tracker updates all tracks to this time. Units are in seconds.

`time` must be greater than or equal to the largest `Time` field value of the `sensorData` structures. `time` must increase in value with each update to the tracker.

Data Types: `single` | `double`

configs — Sensor configurations

array of structures | cell array of structures | cell array of `trackingSensorConfiguration` objects

Sensor configurations, specified as an array of structures, a cell array of structures, or a cell array of `trackingSensorConfiguration` objects. If you specify the value using an array of structures or a cell array of structures, you must include `SensorIndex` as a field in each structure. The other optional fields in each structure must have the same names as the `trackingSensorConfiguration` object properties. You only need to specify sensor configurations that need to be updated. For example, if you want to update the `IsValidTime` property for only the fifth sensor, specify `configs` as `struct('SensorIndex',5,'IsValidTime',false)`.

Dependencies

To enable this argument, set the `HasSensorConfigurationsInput` property to `true`.

Output Arguments

confirmedTracks – Confirmed tracks

array of `objectTrack` objects

Confirmed tracks updated to the current time, returned as an array of `objectTrack` objects, where each element represents the track of an object. The state form of each track follows the form specified in the `MotionModel` property.

tentativeTracks – Tentative tracks

array of `objectTrack` objects

Tentative tracks, returned as an array of `objectTrack` objects, where each element represents the track of an object. The state form of each track follows the form specified in the `MotionModel` property.

allTracks – All tracks

structure | array of objects

All tracks, returned as an array of `objectTrack` objects, where each element represents the track of an object. The state form of each track follows the form specified in the `MotionModel` property.

map – Dynamic evidential grid map

`dynamicEvidentialGridMap` object

Dynamic evidential grid map, returned as a `dynamicEvidentialGridMap` object.

Object Functions

To use an object function, specify the System object as the first input argument. For example, to release system resources of a System object named `obj`, use this syntax:

```
release(obj)
```

Specific to trackerGridRFS

<code>predictTracksToTime</code>	Predict track state
<code>predictMapToTime</code>	Predict dynamic map to a time stamp
<code>showDynamicMap</code>	Plot dynamic occupancy grid map

Common to All System Objects

<code>step</code>	Run System object algorithm
<code>release</code>	Release resources and allow changes to System object property values and input characteristics
<code>isLocked</code>	Determine if System object is in use
<code>clone</code>	Create duplicate System object
<code>reset</code>	Reset internal states of System object

Examples

Track Targets Using Grid-Based Tracker

Create a tracking scenario.

```
scene = trackingScenario('UpdateRate',5,'StopTime',5);
rng(2021); % For reproducible results
```

Add a platform with a mounted lidar sensor to the tracking scenario.

```
plat = platform(scene);
lidar = monostaticLidarSensor(1,'DetectionCoordinates','Body','HasOrganizedOutput',false);
```

Add two targets with random positions and velocities to the scenario. Also, define the trajectory, mesh, and dimension of each platform.

```
for i = 1:2
    target = platform(scene);
    x = 50*(2*rand - 1);
    y = 50*(2*rand - 1);
    vx = 5*(2*rand - 1);
    vy = 5*(2*rand - 1);
    target.Trajectory.Position = [x y 0];
    target.Trajectory.Velocity = [vx vy 0];
    % Align the orientation of the target with the direction of motion.
    target.Trajectory.Orientation = quaternion([atan2d(vy,vx),0,0],'eulerd','ZYX','frame');
    target.Mesh = extendedObjectMesh('sphere');
    target.Dimensions = struct('Length',4,'Width',4,'Height',2,'OriginOffset',[0 0 0]);
end
```

Define the configuration of the lidar sensor.

```
config = trackingSensorConfiguration(1,...
    'SensorLimits',[-180 180;0 100],...
    'SensorTransformParameters',struct,...
    'IsValidTime',true);
```

Create a grid-based tracker.

```
tracker = trackerGridRFS('SensorConfigurations',config,...
    'AssignmentThreshold',5,...
    'MinNumCellsPerCluster',4,...
    'ClusteringThreshold',3);
```

Define a theaterPlot object and two associated plotters for visualizing the tracking scene.

```
tp = theaterPlot('XLimits',[-50 50],'YLimits',[-50 50]);
trkPlotter = trackPlotter(tp,'DisplayName','Tracks','MarkerFaceColor','g');
tthPlotter = platformPlotter(tp,'DisplayName','Truths','MarkerFaceColor','r','ExtentAlpha',0.2);
```

Advance the scenario and run the tracker with the lidar data.

```
while advance(scene)

    time = scene.SimulationTime;

    % Generate point cloud.
    tgtMeshes = targetMeshes(plat);
    [ptCloud, config] = lidar(tgtMeshes, time);
```

```
% Format the data for the tracker.
sensorData = struct('Time',time,...
    'SensorIndex',1,...
    'Measurement',ptCloud',...
    'MeasurementParameters',struct...
    );

% Update the tracker using the sensor data.
tracks = tracker(sensorData, time);

% Visualize tracks.
pos = zeros(numel(tracks),3);
vel = zeros(numel(tracks),3);
orient = quaternion.ones(numel(tracks),1);
dim = repmat(plat.Dimensions,numel(tracks),1);
ids = string([tracks.TrackID]);

for i = 1:numel(tracks)
    vel(i,:) = [tracks(i).State(2);tracks(i).State(4);0];
    pos(i,:) = [tracks(i).State(1);tracks(i).State(3);0];
    dim(i).Length = tracks(i).State(6);
    dim(i).Width = tracks(i).State(7);
    orient(i) = quaternion([tracks(i).State(5) 0 0], 'eulerd', 'ZYX', 'frame');
end
trkPlotter.plotTrack(pos,dim,orient,ids);

% Visualize platforms.
pos = vertcat(tgtMeshes.Position);
meshes = vertcat(tgtMeshes.Mesh);
orient = vertcat(tgtMeshes.Orientation);
tthPlotter.plotPlatform(pos,meshes,orient);
end
```

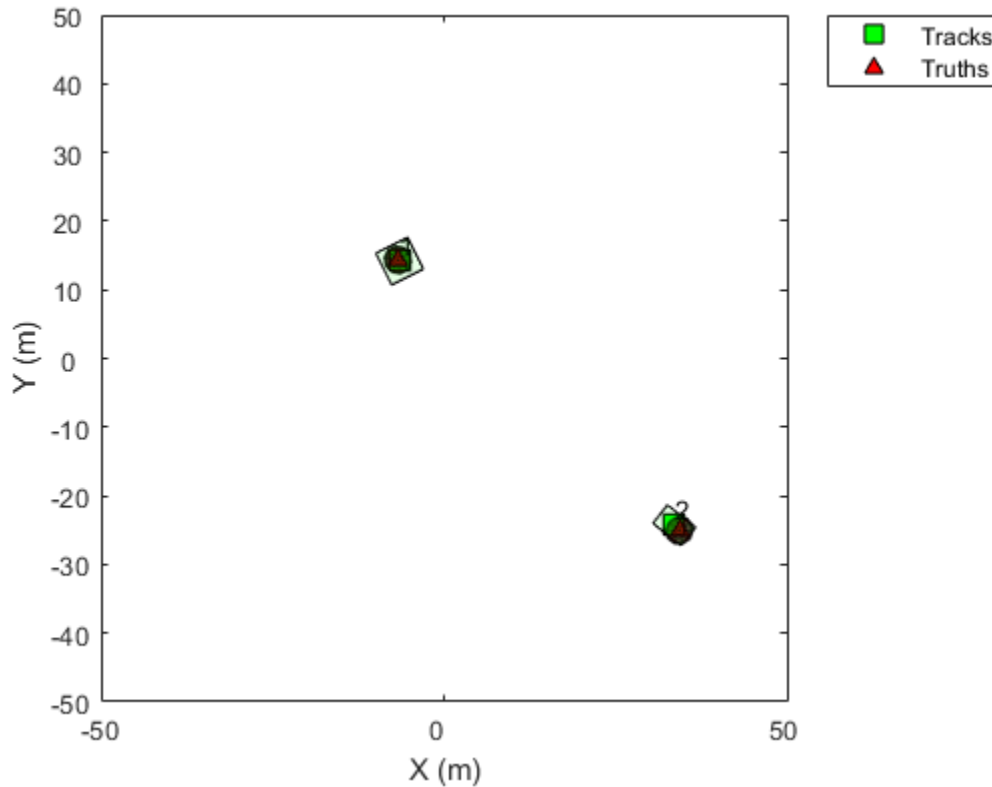

Algorithms

Tracker Logic Flow

The `trackerGridRFS` system object initializes, confirms, and deletes tracks automatically by using this algorithm:

- 1 The tracker projects sensor data from all sensors on a two-dimensional grid map to represent the occupancy and free evidence in a Dempster-Shafer framework.
- 2 The tracker uses a particle-based approach to estimate the dynamic state of the 2-D grid. This helps the tracker to classify each cell as dynamic or static.
- 3 The tracker manage tracks based on this logic:
 - a The tracker associates each dynamic grid cell with the existing tracks using a gated nearest-neighbor approach.
 - b The tracker initializes new tracks using unassigned dynamic grid cells. A track is created with a `Tentative` status, and the status will change to `Confirmed` after enough updates. For more information, see the `ConfirmationThreshold` property.
 - c Alternatively, the tracker confirms a track immediately if the `ObjectClassID` of the track is set to a positive value after track initialization. For more information, see the `TrackInitializationFcn` property.

- d The tracker performs coasting, predicting unassigned tracks to the current time, and deletes tracks with more misses than allowed. For more information, see the `DeletionThreshold` property.

References

- [1] Nuss, D., Reuter, S., Thom, M., Yuan, T., Krehl, G., Maile, M., Gern, A. and Dietmayer, K., 2018. A random finite set approach for dynamic occupancy grid maps with real-time application. *The International Journal of Robotics Research*, 37(8), pp.841-866.
- [2] Steyer, Sascha, Georg Tanzmeister, and Dirk Wollherr. "Object tracking based on evidential dynamic occupancy grids in urban environments." *In 2017 IEEE Intelligent Vehicles Symposium (IV)*, pp. 1064-1070. IEEE, 2017.

Extended Capabilities

C/C++ Code Generation

Generate C and C++ code using MATLAB® Coder™.

See Also

`trackerPHD` | `trackingSensorConfiguration`

Introduced in R2020b

showDynamicMap

Plot dynamic occupancy grid map

Syntax

```
showDynamicMap(tracker)
showDynamicMap(tracker,Name,Value)
```

Description

`showDynamicMap(tracker)` plots the dynamic occupancy grid map in the local coordinates. The static cells are shown using grayscale images, in which the grayness represents the occupancy probability of the cell. The dynamic cells are shown using HSV (hue, saturation, and value) values on an RGB colormap:

- Hue — The orientation angle of the velocity vector divided by 360. As hue increases from 0 to 1, the color changes in the order of red to orange, yellow, green, cyan, blue, magenta, and back to red.
- Saturation — The Mahalanobis distance (d) between the velocity distribution of the grid cell and the zero velocity. A cell with $d > 4$ is drawn with full saturation.
- Value — The occupancy probability of the cell.

`showDynamicMap(tracker,Name,Value)` specifies options using one or more name-value pair arguments. Enclose each Name in quotes. For example, `showDynamicMap(myTracker,"PlotVelocity",true)` plots the dynamic map for `myTracker` with velocity plotting enabled.

Examples

Track Targets Using trackerGridRFS and Show Dynamic Map

Create a tracking scenario.

```
scene = trackingScenario('UpdateRate',5,'StopTime',5);
rng(2021); % For reproducible results
```

Add a platform with a mounted lidar sensor to the tracking scenario.

```
plat = platform(scene);
lidar = monostaticLidarSensor(1,'DetectionCoordinates','Body','HasOrganizedOutput',false);
```

Add two targets with random positions and velocities to the scenario. Also, define the trajectory, mesh, and dimension of each platform.

```
for i = 1:2
    target = platform(scene);
    x = 50*(2*rand - 1);
    y = 50*(2*rand - 1);
    vx = 5*(2*rand - 1);
```

```
vy = 5*(2*rand - 1);
target.Trajectory.Position = [x y 0];
target.Trajectory.Velocity = [vx vy 0];
% Align the orientation of the target with the direction of motion.
target.Trajectory.Orientation = quaternion([atan2d(vy,vx),0,0], 'eulerd', 'ZYX', 'frame');
target.Mesh = extendedObjectMesh('sphere');
target.Dimensions = struct('Length',4,'Width',4,'Height',2,'OriginOffset',[0 0 0]);
end
```

Define the configuration of the lidar sensor.

```
config = trackingSensorConfiguration(1,...
    'SensorLimits',[-180 180;0 100],...
    'SensorTransformParameters',struct,...
    'IsValidTime',true);
```

Create a grid-based tracker.

```
tracker = trackerGridRFS('SensorConfigurations',config,...
    'AssignmentThreshold',5,...
    'MinNumCellsPerCluster',4,...
    'ClusteringThreshold',3);
```

Advance the scenario and run the tracker with the lidar data.

```
while advance(scene)

    time = scene.SimulationTime;

    % Generate point cloud.
    tgtMeshes = targetMeshes(plat);
    [ptCloud, config] = lidar(tgtMeshes, time);

    % Format the data for the tracker.
    sensorData = struct('Time',time,...
        'SensorIndex',1,...
        'Measurement',ptCloud,...
        'MeasurementParameters',struct...
    );
    % Update the tracker using the sensor data.
    tracks = tracker(sensorData, time);
end
```

Show the dynamic map.

```
showDynamicMap(tracker)
xlabel('x (m)');
ylabel('y (m)');
```

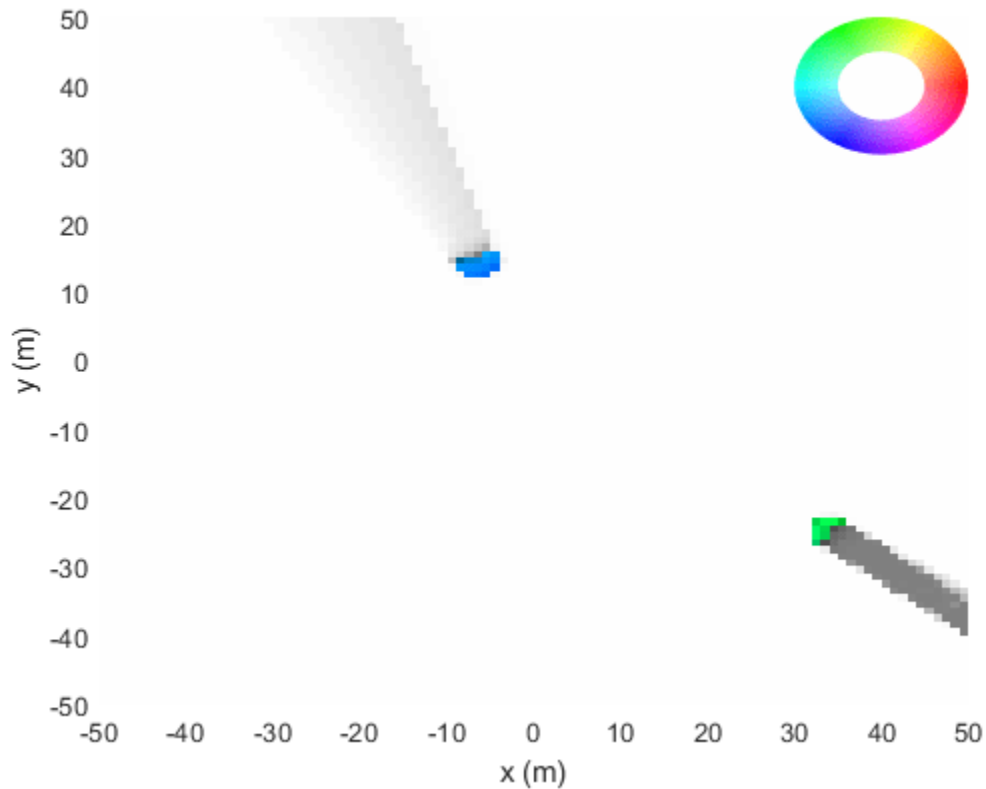

Input Arguments

tracker — Grid-based RFS tracker

trackerGridRFS object

Grid-based RFS tracker, specified as a trackerGridRFS object.

Name-Value Pair Arguments

Specify optional comma-separated pairs of Name, Value arguments. Name is the argument name and Value is the corresponding value. Name must appear inside quotes. You can specify several name and value pair arguments in any order as Name1, Value1, ..., NameN, ValueN.

Example: showDynamicMap(myTracker, "PlotVelocity", false) plots the dynamic map for myTracker with velocity plotting enabled.

PlotVelocity — Enable velocity plotting

false (default) | true

Enable velocity plotting, specified as true or false. When specified as true, the velocity vector for each dynamic cell is plotted at the center of the grid cell. The length of the plotted vector represents the magnitude of the velocity.

Parent — Parent axes

gca | Axes handle

Parent axes on which to plot the map, specified as an Axes handle.

FastUpdate — Enable updating from previous map

`true` (default) | `false`

Enable updating from previous map, specified as `true` or `false`. When specified as `true`, the function plots the map via a lightweight update to the previous map in the figure. When specified as `false`, the function plots a new map on the figure every time.

InvertColors — Enable inverted colors

`false` (default) | `true`

Enable inverted colors on the map, specified as `true` or `false`. When specified as `false`, the function plots empty space in white and occupied space in black. When specified as `true`, the function plots empty space in black and occupied space in white.

See Also

`trackerGridRFS`

Introduced in R2020b

predictMapToTime

Predict dynamic map to a time stamp

Syntax

```
map = predictMapToTime(tracker,time)
___ = predictMapToTime( ____, 'WithStateAndCovariance', tf)
```

Description

`map = predictMapToTime(tracker,time)` returns the map of the tracker predicted to the specified time.

Note This function only outputs the predicted map and does change the results when calling the `step` method of the tracker. Use these three tunable properties (`FreeSpaceDiscountFactor`, `DeathRate`, and `ProcessNoise`) of the tracker to control how uncertainties impact the prediction of the map.

`___ = predictMapToTime(____, 'WithStateAndCovariance', tf)` additionally specifies whether the function predicts the state and state covariance of the map. If `tf` is specified as `false`, only the evidences and occupancy of the map is predicted. The state, state covariance, and classification of a cell as static or dynamic are not predicted. Specifying `tf` as `false` allows you to predict the occupancy of the environment faster.

Examples

Predict Grid Map in trackerGridRFS

Create a tracking scenario.

```
rng(2021);% For reproducible results
scene = trackingScenario('UpdateRate',5,'StopTime',15);
```

Add a platform. Mount a lidar sensor on the platform.

```
plat = platform(scene);
lidar = monostaticLidarSensor(1,'DetectionCoordinates','Body');
```

Add two targets and define their position, velocity, orientation, dimension, and meshes.

```
for i = 1:2
    target = platform(scene);
    xStart = 50*(2*rand-1);
    xFinal = 50*(2*rand-1);
    yStart = 50*(2*rand-1);
    yFinal = 50*(2*rand-1);
    target.Trajectory = waypointTrajectory([xStart yStart 0;xFinal yFinal 0],[0 15]);
    target.Mesh = extendedObjectMesh('sphere');
```

```
target.Dimensions = struct('Length',4, ...
    'Width',4, ...
    'Height',2, ...
    'OriginOffset',[0 0 0]);
end
```

Define the configuration of the sensor.

```
config = trackingSensorConfiguration(1, ...
    'SensorLimits',[-180 180;0 100], ...
    'SensorTransformParameters',struct, ...
    'IsValidTime',true);
```

Create a grid-based tracker.

```
tracker = trackerGridRFS('SensorConfigurations',config, ...
    'AssignmentThreshold',5, ...
    'MinNumCellsPerCluster',4, ...
    'ClusteringThreshold',3);
```

Advance scenario and run the tracker based on the lidar data.

```
while advance(scene)
    time = scene.SimulationTime;
    % Generate point cloud
    tgtMeshes = targetMeshes(plat);
    [ptCloud,config] = lidar(tgtMeshes,time);

    % Format the data for the tracker
    sensorData = struct('Time',time, ...
        'SensorIndex',1, ...
        'Measurement',ptCloud', ...
        'MeasurementParameters',struct ...
        );

    % Call tracker using sensorData to obtain the map in addition
    % to tracks
    [tracks,~,~,map] = tracker(sensorData,time);
end
```

Show the final map.

```
figure
show(map)
```

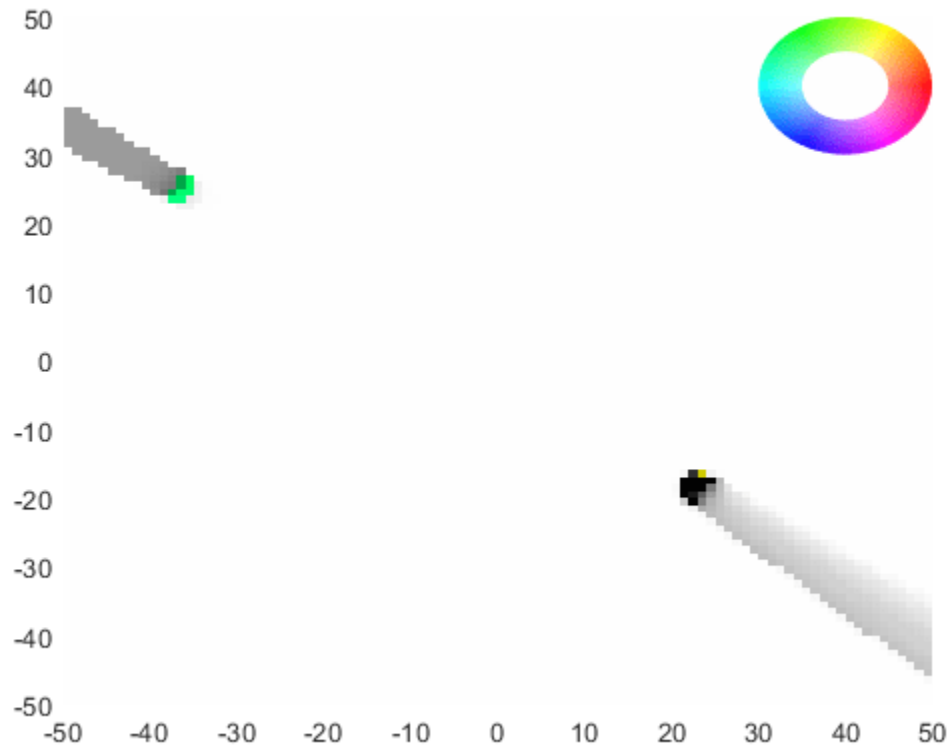

Make a few assumptions before predicting the map.

```
% Assume free space remains free during prediction
```

```
f = tracker.FreeSpaceDiscountFactor;
tracker.FreeSpaceDiscountFactor = 1;
```

```
% Assume no targets die during prediction
```

```
d = tracker.DeathRate;
tracker.DeathRate = 0;
```

```
% Assume no process noise during prediction
```

```
q = tracker.ProcessNoise;
tracker.ProcessNoise = zeros(size(q));
```

Predict the map 1 second forward and show the predicted map.

```
figure
predictedMap = predictMapToTime(tracker,16)
```

```
predictedMap =
dynamicEvidentialGridMap with properties:
```

```
    NumStateVariables: 4
        MotionModel: 'constant-velocity'
        GridLength: 100
        GridWidth: 100
    GridResolution: 1
```

```
GridOriginInLocal: [-50 -50]
```

```
show(predictedMap)
```

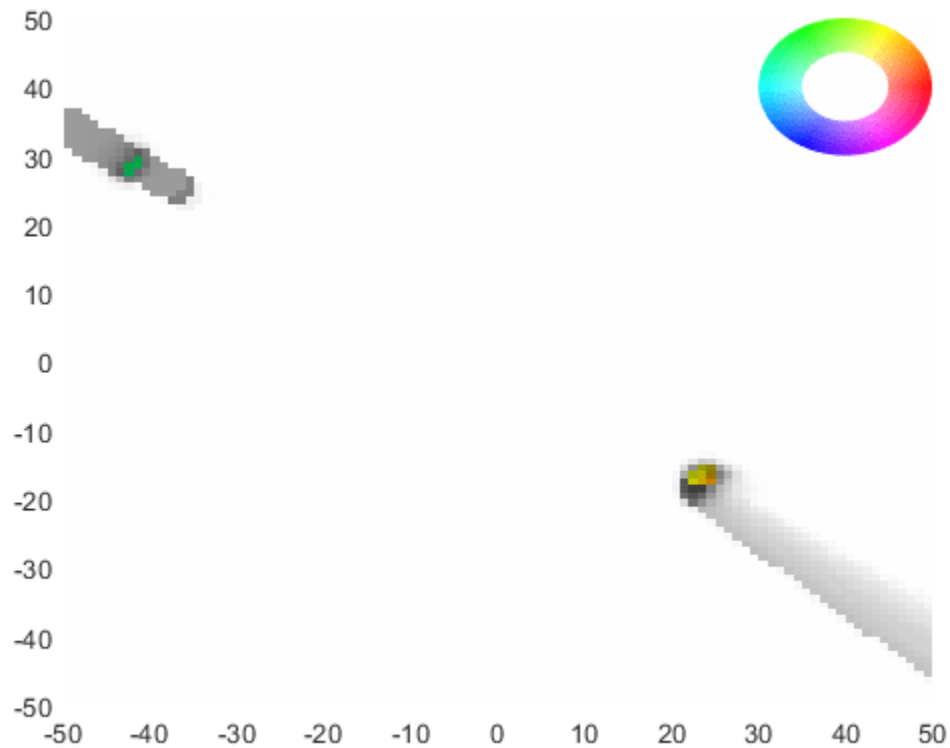

Restore property values for the tracker.

```
tracker.FreeSpaceDiscountFactor = f;  
tracker.DeathRate = d;  
tracker.ProcessNoise = q;
```

Input Arguments

tracker — Grid-based RFS tracker

trackerGridRFS object

Grid-based RFS tracker, specified as a trackerGridRFS object.

time — Prediction time

positive scalar

Prediction time, specified as a positive scalar. The dynamic map of the tracker is predicted to this time. The time must be greater than the time input to the tracker in the previous track update. Units are in seconds.

Example: 1.0

Data Types: `single` | `double`

tf — Enable state and state covariance prediction

`true` (default) | `false`

Enable state and state covariance prediction, specified as `true` or `false`. Specifying it as `false` allows you to predict the occupancy of the environment faster.

Data Types: `logical`

Output Arguments

map — Map after prediction

`dynamicEvidentialGridMap` object

Map after prediction, returned as a `dynamicEvidentialGridMap` object.

See Also

`dynamicEvidentialGridMap` | `trackerGridRFS`

Introduced in R2021a

trackerPHD

Multi-sensor, multi-object PHD tracker

Description

The `trackerPHD` System object is a tracker capable of processing detections of multiple targets from multiple sensors. The tracker uses a multi-target probability hypothesis density (PHD) filter to estimate the states of point targets and extended objects. PHD is a function defined over the state-space of the tracking system, and its value at a state is defined as the expected number of targets per unit state-space volume. The PHD is represented by a weighted summation (mixture) of probability density functions, and peaks in the PHD correspond to possible targets. For an overview of how the tracker functions, see “Algorithms” on page 3-527.

By default, the `trackerPHD` can track extended objects using the `ggiwphd` filter, which models detections from an extended object as a parse points cloud. You can also use `trackerPHD` with the `gmphd` filters, which tracks point targets and extended objects with designated shapes. Inputs to the tracker are detection reports generated by `objectDetection`, `fusionRadarSensor`, `irSensor`, or `sonarSensor` objects. The tracker outputs all maintained tracks and their analysis information.

To track targets using this object:

- 1 Create the `trackerPHD` object and set its properties.
- 2 Call the object with arguments, as if it were a function.

To learn more about how System objects work, see [What Are System Objects?](#).

Creation

Syntax

```
tracker = trackerPHD  
tracker = trackerPHD(Name, Value)
```

Description

`tracker = trackerPHD` creates a `trackerPHD` System object with default property values.

`tracker = trackerPHD(Name, Value)` sets properties for the tracker using one or more name-value pairs. For example, `trackerPHD('MaxNumTracks', 100)` creates a PHD tracker that allows a maximum of 100 tracks. Enclose each property name in quotes.

Properties

Unless otherwise indicated, properties are *nontunable*, which means you cannot change their values after calling the object. Objects lock when you call them, and the `release` function unlocks them.

If a property is *tunable*, you can change its value at any time.

For more information on changing property values, see System Design in MATLAB Using System Objects.

TrackerIndex — Unique tracker identifier

0 (default) | nonnegative integer

Unique tracker identifier, specified as a nonnegative integer. This property is used as the `SourceIndex` in the tracker outputs, and distinguishes tracks that come from different trackers in a multiple-tracker system. You must specify this property as a positive integer to use the track outputs as inputs to a track fuser.

Example: 1

SensorConfigurations — Configurations of tracking sensors

cell array of `trackingSensorConfiguration` objects

Configuration of tracking sensors, specified as a cell array of `trackingSensorConfiguration` objects. This property provides the tracking sensor configuration information, such as sensor detection limits and sensor resolution, to the tracker. Note that there are no default values for the `SensorConfigurations` property, and you must specify the `SensorConfigurations` property before using the tracker. However, you can update the configuration by setting the `HasSensorConfigurationsInput` property to `true` and specifying the configuration input, `config`. If you set the `MaxDetsPerObject` property of the `trackingSensorConfiguration` object to 1, the tracker creates only one partition, such that at most one detection can be assigned to each target.

PartitioningFcn — Function to partition detections into detection cells

@partitionDetections (default) | function handle | character vector

Function to partition detections into detection cells, specified as a function handle or as a character vector. When each sensor can report more than one detection per object, a partition function is required. The partition function reports all possible partitions of the detections from a sensor. In each partition, the detections are separated into mutually exclusive detection cells, assuming that each detection cell belongs to one extended object.

You can also specify your own detections partition function. For guidance in writing this function, you can examine the details of the default partitioning function, `partitionDetections`, using the `type` command as:

```
type partitionDetections
```

Example: @myfunction or 'myfunction'

Data Types: `function_handle` | `char`

BirthRate — Birth rate of new targets in the density

1e-3 (default) | positive real scalar

Birth rate of new targets in the density, specified as a scalar. Birth rate indicates the expected number of targets added in the density per unit time. The birth density is created by using the `FilterInitializationFcn` of the `trackingSensorConfiguration` used with the tracker. In general, the tracker adds components to the density function in two ways:

- 1 Predictive birth density - density initialized by `FilterInitializationFcn` function when called with no inputs.

- Adaptive birth density - density initialized by `FilterInitializationFcn` function when called with detections inputs. The detections are chosen by the tracker based on their log-likelihood of association with the current estimates of the targets.

Note that the value for the `BirthRate` property represents the summation of both predictive birth density and adaptive birth density for each time step.

Example: 0.01

Data Types: `single` | `double`

DeathRate – Death rate of components in the density

1e-6 (default) | positive real scalar

Death rate of components in the density, specified as a scalar. Death rate indicates the rate at which a component vanishes in the density after one time step. Death rate (P_d) relates to the survival probability (P_s) of a component between successive time steps by

$$P_s = (1 - P_d)^{\Delta T}$$

where ΔT is the time step.

Example: 1e-4

Data Types: `single` | `double`

AssignmentThreshold – Threshold of selecting detections for component initialization

25 (default) | real positive scalar

Threshold of selecting detections for component initialization, specified as a positive scalar. During correction, the tracker calculates the likelihood of association between existing tracks and detection cells. If the association likelihood (given by negative log-likelihood) of a detection cell to all existing tracks is higher than the threshold (which means the detection cell has low likelihood of association to existing tracks), the detection cell is used to initialize new components in the adaptive birth density.

Example: 18.1

Data Types: `single` | `double`

ExtractionThreshold – Threshold for initializing tentative track

0.5 (default) | real positive scalar

Threshold for initializing a tentative track, specified as a scalar. If the weight of a component is higher than the threshold specified by the `ExtractionThreshold` property, the component is labeled as a 'Tentative' track and given a `TrackID`.

Example: 0.45

Data Types: `single` | `double`

ConfirmationThreshold — Threshold for track confirmation

0.8 (default) | real positive scalar

Threshold for track confirmation, specified as a scalar. In a trackerPHD object, a track can have multiple components sharing the same TrackID. If the weight summation of a tentative track's components is higher than the threshold specified by the ConfirmationThreshold property, the track's status is marked as 'Confirmed'.

Example: 0.85

Data Types: single | double

DeletionThreshold — Threshold for component deletion

1e-3 (default) | real positive scalar

Threshold for component deletion, specified as a scalar. In the PHD tracker, if the weight of a component is lower than the value specified by the DeletionThreshold property, the component is deleted.

Example: 0.01

Data Types: single | double

MergingThreshold — Threshold for components merging

25 (default) | real positive scalar

Threshold for components merging, specified as a real positive scalar. In the PHD tracker, if the Kullback-Leibler distance between components with the same TrackID is smaller than the value specified by the MergingThreshold property, then these components are merged into one component. The merged weight of the new component is equal to the summation of the weights of the pre-merged components. Moreover, if the merged weight is higher than the first threshold specified in the LabelingThresholds property, the merged weight is truncated to the first threshold. Note that components with TrackID equal to 0 can also be merged with each other.

Example: 30

Data Types: single | double

LabelingThresholds — Thresholds for label management

[1.1 1 0.8] (default) | 1-by-3 vector of positive values

Labeling thresholds, specified as an 1-by-3 vector of decreasing positive values, $[C_1, C_2, C_3]$. Based on the LabelingThresholds property, the tracker manages components in the density using these rules:

- 1 The weight of any component that is higher than the first threshold C_1 is reduced to C_1 .
- 2 For all components with the same TrackID, if the largest weight among these components is greater than C_2 , then the component with the largest weight is preserved to retain the TrackID, while all other components are deleted.
- 3 For all components with the same TrackID, if the ratio of the largest weight to the weight summation of all these components is greater than C_3 , then the component with the largest weight is preserved to retain the TrackID, while all other components are deleted.
- 4 If neither condition 2 nor condition 3 is satisfied, then the component with the largest weight retains the TrackID, while the labels of all other components are set to 0. When this occurs, it essentially means that some components may represent other objects. This treatment keeps the possibility for these unreserved components to be extracted again in the future.

Data Types: `single` | `double`

HasSensorConfigurationsInput — Enable updating sensor configurations with time

`false` (default) | `true`

Enable updating sensor configurations with time, specified as `false` or `true`. Set this property to `true` if you want the configurations of the sensor updated with time. Also, when this property is set to `true`, the tracker must be called with the configuration input, `config`, as shown in the usage syntax.

Data Types: `logical`

StateParameters — Parameters of track state reference frame

`struct([])` (default) | `struct array`

Parameters of the track state reference frame, specified as a structure or a structure array. The tracker passes its `StateParameters` property values to the `StateParameters` property of the generated tracks. You can use these parameters to define the reference frame in which the track is reported or other desirable attributes of the generated tracks.

For example, you can use the following structure to define a rectangular reference frame whose origin position is at `[10 10 0]` meters and whose origin velocity is `[2 -2 0]` meters per second with respect to the scenario frame.

Field Name	Value
Frame	"Rectangular"
Position	[10 10 0]
Velocity	[2 -2 0]

Tunable: Yes

Data Types: `struct`

NumTracks — Number of tracks maintained by tracker

nonnegative integer

This property is read-only.

Number of tracks maintained by the tracker, returned as a nonnegative integer.

Data Types: `double`

NumConfirmedTracks — Number of confirmed tracks

nonnegative integer

This property is read-only.

Number of confirmed tracks, returned as a nonnegative integer. If the `IsConfirmed` field of an output track structure is `true`, the track is confirmed.

Data Types: `double`

MaxNumSensors — Maximum number of sensors

20 (default) | positive integer

Maximum number of sensors that can be connected to the tracker, specified as a positive integer. `MaxNumSensors` must be greater than or equal to the largest value of `SensorIndex` found in all the detections used to update the tracker. `SensorIndex` is a property of an `objectDetection` object.

Data Types: `single` | `double`

MaxNumTracks – Maximum number of tracks

100 (default) | positive integer

Maximum number of tracks that the tracker can maintain, specified as a positive integer.

Data Types: `single` | `double`

Usage

To process detections and update tracks, call the tracker with arguments, as if it were a function (described here).

Syntax

```
confirmedTracks = tracker(detections,time)
confirmedTracks = tracker(detections,config,time)
[confirmedTracks,tentativeTracks,allTracks] = tracker(____)
[confirmedTracks,tentativeTracks,allTracks,analysisInformation] = tracker(____)
)
```

Description

`confirmedTracks = tracker(detections,time)` returns a list of confirmed tracks that are updated from a list of detections, `detections`, at the update time, `time`. Confirmed tracks are corrected and predicted to the update time.

`confirmedTracks = tracker(detections,config,time)` also specifies a sensor configuration input, `config`. Use this syntax when the configurations of sensors are changing with time. To enable this syntax, set the `HasSensorConfigurationsInput` property to `true`.

`[confirmedTracks,tentativeTracks,allTracks] = tracker(____)` also returns a list of tentative tracks, `tentativeTracks`, and a list of all tracks, `allTracks`. You can use this output syntax with any of the previous input syntaxes.

`[confirmedTracks,tentativeTracks,allTracks,analysisInformation] = tracker(____)` also returns the analysis information, `analysisInformation`, which can be used for track analysis. You can use this output syntax with any of the previous input syntaxes.

Input Arguments

detections – Detection list

cell array of `objectDetection` objects

Detection list, specified as a cell array of `objectDetection` objects. The `Time` property value of each `objectDetection` object must be less than or equal to the current update time, `time`, and greater than the previous time value used to update the tracker. Also, the `Time` differences between different `objectDetection` objects in the cell array do not need to be equal.

time — Time of update

scalar

Time of update, specified as a scalar. The tracker updates all tracks to this time. Units are in seconds.

`time` must be greater than or equal to the largest `Time` property value of the `objectDetection` objects in the input `detections` list. `time` must increase in value with each update to the tracker.

Data Types: `single` | `double`**config — Sensor configurations**array of structs | cell array of structs | cell array of `trackingSensorConfiguration` objects

Sensor configurations, specified as an array of structs, a cell array of structs, or a cell array of `trackingSensorConfiguration` objects. If you specify the value using an array of structs or a cell array of structs, you must include `SensorIndex` as a field for each struct. The other optional fields in each struct must have the same name as one of the properties of the `trackingSensorConfiguration` object. Note that you only need to specify sensor configurations that need to be updated. For example, if you only want to update the `IsValidTime` property for the fifth sensor, provide the value for `config` as `struct('SensorIndex',5,'IsValidTime',false)`.

Dependencies

To enable this argument, set the `HasSensorConfigurationsInput` property to `true`.

Output Arguments**confirmedTracks — Confirmed tracks**

structure | array of structures

Confirmed tracks updated to the current time, returned as a structure or an array of structures. Each structure corresponds to a track. A track is confirmed if the weight summation of its components is above the threshold specified by the `ConfirmationThreshold` property. If a track is confirmed, the `IsConfirmed` field of the structure is `true`. The fields of the confirmed tracks structure are defined in “Track Structure” on page 3-526.

Data Types: `struct`**tentativeTracks — Tentative tracks**

structure | array of structures

Tentative tracks, returned as a structure or an array of structures. Each structure corresponds to a track. A track is tentative if the weight summation of its components is above the threshold specified by the `ExtractionThreshold` property, but below the threshold specified by the `ConfirmationThreshold` property. In that case, the `IsConfirmed` field of the structure is `false`. The fields of the structure are defined in “Track Structure” on page 3-526.

Data Types: `struct`**allTracks — All tracks**

structure | array of structures

All tracks, returned as a structure or an array of structures. Each structure corresponds to a track. The set of all tracks consists of confirmed and tentative tracks. The fields of the structure are defined in “Track Structure” on page 3-526.

Data Types: `struct`

analysisInformation – Additional information for analyzing track updates

structure

Additional information for analyzing track updates, returned as a structure. The fields of this structure are:

Field	Description
CorrectionOrder	The order in which sensors are used for state estimate correction, returned as a row vector of <code>SensorIndex</code> . For example, [1 3 2 4].
TrackIDsAtStepBeginning	Track IDs when step began.
DeletedTrackIDs	IDs of tracks deleted during the step.
TrackIDsAtStepEnd	Track IDs when the step ended.
SensorAnalysisInfo	Cell array of sensor analysis information.

The `SensorAnalysisInfo` field can include multiple sensor information reports. Each report is a structure containing:

Field	Description
SensorIndex	Sensor index.
DetectionCells	Detection cells, returned as a logical matrix. Each column of the matrix denotes a detection cell. In each column, if the i th element is 1, then the i th detection belongs to the detection cell denoted by that column.
DetectionLikelihoods	The association likelihoods between components in the density function and detection cells, returned as an N -by- P matrix. N is the number of components in the density function, and P is the number of detection cells.
IsBirthCells	Indicates if the detection cells listed in <code>DetectionCells</code> give birth to new tracks, returned as a 1-by- P logical vector, where P is the number of detection cells.
NumPartitions	Number of partitions.
DetectionProbability	Probability of existing tracks being detected by the sensor, specified as a 1-by- N row vector, where N is the number of components in the density function.
LabelsBeforeCorrection	Labels of components in the density function before correction, return as a 1-by- M_b row vector. M_b is the number of components maintained in the tracker before correction. Each element of the vector is a <code>TrackID</code> . For example, [1 1 2 0 0]. Note that multiple components can share the same <code>TrackID</code> .

LabelsAfterCorrection	Labels of components in the density function after correction, returned as a 1-by- M_a row vector. M_a is the number of components maintained in the tracker after correction. Each element of the vector is a TrackID. For example, [1 1 1 2 2 0 0]. Note that multiple components can share the same TrackID.
WeightsBeforeCorrection	Weights of components in the density function before correction, returned as a 1-by- M_b row vector. M_b is the number of components maintained in the tracker before correction. Each element of the vector is the weight of the corresponding component given in LabelsBeforeCorrection. For example, [0.1 0.5 0.7 0.3 0.2].
WeightsAfterCorrection	Weights of components in the density function after correction, returned as a 1-by- M_a row vector. M_a is the number of components maintained in the tracker after correction. Each element of the vector is the weight of the corresponding component given in LabelsAfterCorrection. For example, [0.1 0.4 0.2 0.6 0.3 0.2 0.2].

Data Types: struct

Object Functions

To use an object function, specify the System object as the first input argument. For example, to release system resources of a System object named `obj`, use this syntax:

```
release(obj)
```

Specific to trackerPHD

<code>predictTracksToTime</code>	Predict track state
<code>deleteTrack</code>	Delete existing track
<code>initializeTrack</code>	Initialize new track
<code>sensorIndices</code>	List of sensor indices

Common to All System Objects

<code>step</code>	Run System object algorithm
<code>release</code>	Release resources and allow changes to System object property values and input characteristics
<code>isLocked</code>	Determine if System object is in use
<code>clone</code>	Create duplicate System object
<code>reset</code>	Reset internal states of System object

Examples

Track Two Objects Using trackerPHD

Set up the sensor configuration, create a PHD tracker, and feed the tracker with detections.

```
% Create sensor configuration. Specify clutter density of the sensor and
% set the IsValidTime property to true.
configuration = trackingSensorConfiguration(1);
configuration.ClutterDensity = 1e-7;
configuration.IsValidTime = true;

% Create a PHD tracker.
tracker = trackerPHD('SensorConfigurations',configuration);

% Create detections near points [5;-5;0] and [-5;5;0] at t=0, and
% update the tracker with these detections.
detections = cell(20,1);
for i = 1:10
    detections{i} = objectDetection(0,[5;-5;0] + 0.2*randn(3,1));
end
for j = 11:20
    detections{j} = objectDetection(0,[-5;5;0] + 0.2*randn(3,1));
end

tracker(detections,0);
```

Update the tracker again after 0.1 seconds by assuming that targets move at a constant velocity of [1;2;0] unit per second.

```
dT = 0.1;
for i = 1:20
    detections{i}.Time = detections{i}.Time + dT;
    detections{i}.Measurement = detections{i}.Measurement + [1;2;0]*dT;
end
[confTracks,tentTracks,allTracks] = tracker(detections,dT);
```

Visualize detections and confirmed tracks.

```
% Obtain measurements from detections.
d = [detections{:}];
measurements = [d.Measurement];

% Extract positions of confirmed tracking using getTrackPositions function.
% Note that we used the default sensor configuration
% FilterInitializationFcn, initcvggiwphd, which uses a constant velocity
% model and defines the states as [x;vx;y;vy;z;vy].
positionSelector = [1 0 0 0 0 0;0 0 1 0 0 0;0 0 0 0 1 0];
positions = getTrackPositions(confTracks,positionSelector);

figure()
plot(measurements(1,:),measurements(2,:), 'x', 'MarkerSize',5, 'MarkerEdgeColor', 'b');
hold on;
plot(positions(1,1),positions(1,2), 'v', 'MarkerSize',5, 'MarkerEdgeColor', 'r' );
hold on;
plot(positions(2,1),positions(2,2), '^', 'MarkerSize',5, 'MarkerEdgeColor', 'r' );
legend('Detections', 'Track 1', 'Track 2')
xlabel('x')
ylabel('y')
```

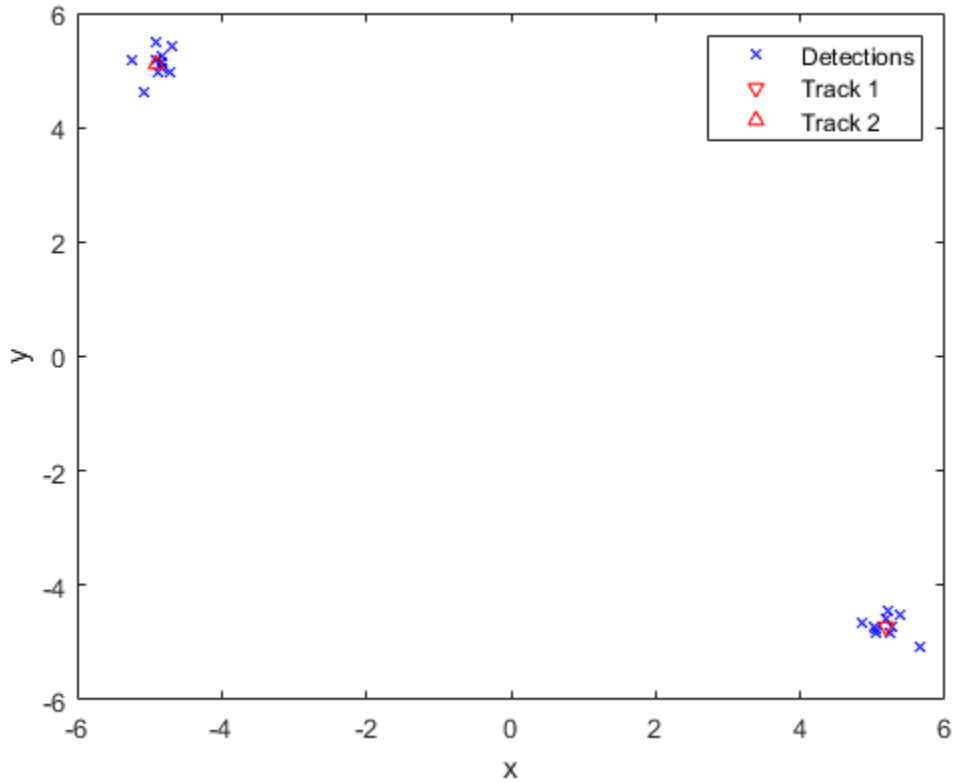

More About

Track Structure

Track information is returned as an array of structures having the following fields:

Field	Description
TrackID	Unique integer that identifies the track.
SourceIndex	Unique identifier of the tracker in a multiple tracker environment. The SourceIndex is exactly the same with the TrackerIndex.
UpdateTime	The time the track was updated.
Age	Number of times the track survived.
State	Value of state vector at the update time.
StateCovariance	Uncertainty covariance matrix.
Extent	Spatial extent estimate of the tracked object, returned as a d -by- d matrix, where d is the dimension of the object. This field is only returned when the tracking filter is specified as a <code>ggiwphd</code> filter.

MeasurementRate	Expected number of detections from the tracked object. This field is only returned when the tracking filter is specified as a <code>ggiwphd</code> filter.
IsConfirmed	True if the track is assumed to be of a real target.
IsCoasted	<code>trackerPHD</code> does not support the <code>IsCoasted</code> field. The value is always 0.
ObjectClassID	<code>trackerPHD</code> does not support the <code>ObjectClassID</code> field. The value is always 0.
StateParameters	Parameters about the track state reference frame specified in the <code>StateParameters</code> property of the PHD tracker.
IsSelfReported	Indicate if the track is reported by the tracker. This field is used in a track fusion environment. It is returned as <code>true</code> by default.

Algorithms

Tracker Logic Flow

`trackerPHD` adopts an iterated-corrector approach to update the probability hypothesis density by processing detection information from multiple sensors sequentially. The workflow of `trackerPHD` follows these steps:

- 1 The tracker sorts sensors according to their detection reporting time and determines the order of correction accordingly.
- 2 The tracker considers two separate densities: current density and birth density. The current density is the density of targets propagated from the previous time step. The birth density is the density of targets expected to be born in the current time step.
- 3 For each sensor:
 - a The tracker predicts the current density to sensor time-stamp using the survival probability calculated from `DeathRate` and the elapsed time from the last prediction.
 - b The tracker adds new components to the birth density using the `FilterInitializationFcn` with no inputs. This corresponds to the predictive birth density.
 - c The tracker creates partitions of the detections from the current sensor using the function specified by the `PartitioningFcn` property. Each partition is a possible segmentation of detections into detection cells for each object. If the `SensorConfiguration` specifies the `MaxNumDetsPerObject` as 1, the tracker generates only 1 partition, in which each detection is a standalone cell.
 - d Each detection cell is evaluated against the current density, and a log-likelihood value is computed for each detection cell.
 - e Using the log-likelihood values, the tracker calculates the probability of each partition.
 - f The tracker corrects the current density using each detection cell.
 - g For detection cells with high negative log-likelihood (greater than `AssignmentThreshold`), the tracker adds new components to the birth density using `FilterInitializationFcn`. This corresponds to the adaptive birth density.

- 4 After correcting the current density with each sensor, the tracker adds the birth density to the current density. The tracker makes sure that number of possible targets in the birth density is equal to $\text{BirthRate} \times dT$, where dT is the time step.
- 5 The current density is then predicted to the current update time.

Probability Hypothesis Density

Probability hypothesis density (PHD) is a function defined over the state-space of the tracking system, and its value at a state is defined as the expected number of targets per unit state-space volume. The PHD is usually approximated by a mixture of components, and each component corresponds to an estimate of the state. The commonly used approximations of PHD are Gaussian mixture, SMC mixture, GGIW mixture, and GIW mixture.

To understand PHD, take the Gaussian mixture as an example. The Gaussian mixture can be represented by

$$D(x) = \sum_{i=1}^M w_i N(x | m_i, P_i)$$

where M is the total number of components, $N(x|m_i, P_i)$ is a normal distribution with mean m_i and covariance P_i , and w_i is the weight of the i th component. The weight w_i denotes the number, which can be fractional, of targets represented by the i th component. Integration of $D(x)$ over a state-space region results in the expected number of targets in that region. Integrating $D(x)$ over the whole state space results in the total expected number of targets ($\sum w_i$), since the integration of a normal distribution over the whole state space is 1. The x -coordinates of the peaks (local maximums) of $D(x)$ represent the most likely states of targets.

For example, the following figure illustrates a PHD function given by $D(x) = N(x|-4,2) + 0.5N(x|3,0.4) + 0.5N(x|4,0.4)$. The weight summation of these components is 2, which means that two targets probably exist. From the peaks of $D(x)$, the possible positions of these targets are at $x = -4$, $x = 3$, and $x = 4$. Notice that the last two components are very close to each other, which means that these two components can possibly be attributed to one object.

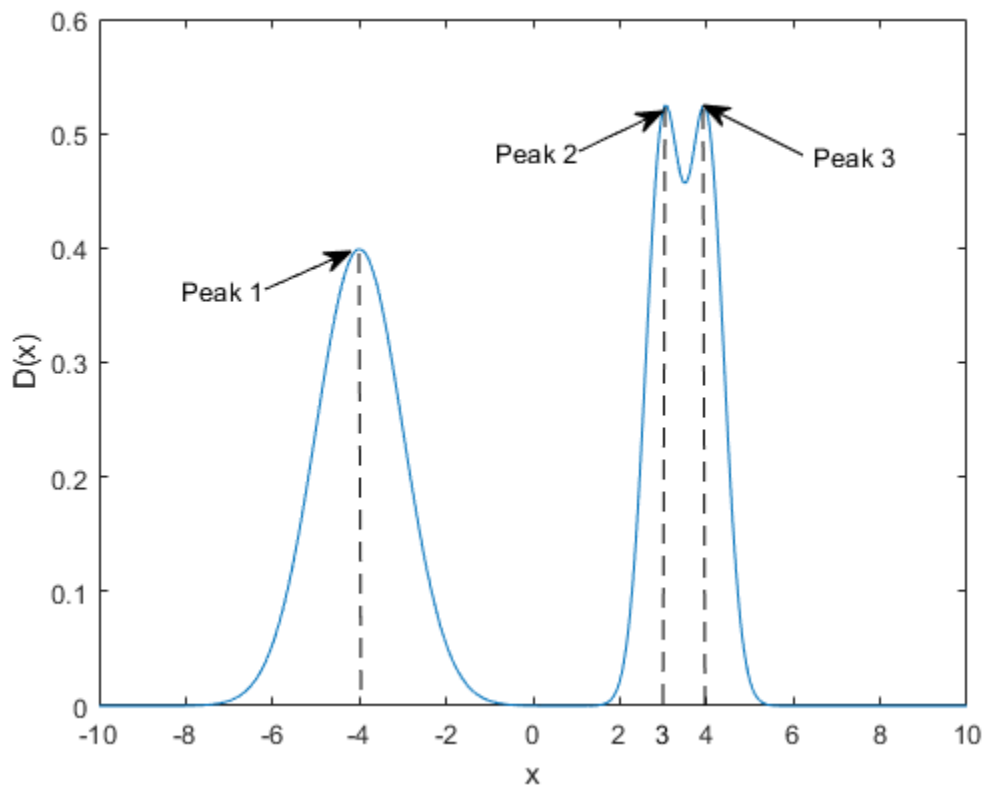

References

- [1] Granstorm, K., C. Lundquist, and O. Orguner. "Extended target tracking using a Gaussian-mixture PHD filter." *IEEE Transactions on Aerospace and Electronic Systems*. Vol. 48, Number 4, 2012, pp. 3268-3286.
- [2] Granstorm, K., and O. Orguner. "A PHD filter for tracking multiple extended targets using random matrices." *IEEE Transactions on Signal Processing*. Vol. 60, Number 11, 2012, pp. 5657-5671.
- [3] Granstorm, K., and A. Natale, P. Braca, G. Ludeno, and F. Serafino. "Gamma Gaussian inverse Wishart probability hypothesis density for extended target tracking using X-band marine radar data." *IEEE Transactions on Geoscience and Remote Sensing*. Vol. 53, Number 12, 2015, pp. 6617-6631.

Extended Capabilities

C/C++ Code Generation

Generate C and C++ code using MATLAB® Coder™.

Usage notes and limitations:

- See "System Objects in MATLAB Code Generation" (MATLAB Coder).
- All the detections must have properties with the same sizes and types.

See Also

Functions

getTrackPositions | getTrackVelocities | partitionDetections | predictTracksToTime

Objects

objectDetection | trackingSensorConfiguration

Objects

staticDetectionFuser | trackerGNN | trackerJPDA | trackerTOMHT

Introduced in R2019a

initializeTrack

Initialize new track

Syntax

```
trackID = initializeTrack(tracker, track)
trackID = initializeTrack(tracker, track, filter)
```

Description

`trackID = initializeTrack(tracker, track)` initializes a new track in the PHD tracker. The tracker must be updated at least once before initializing a track. If the track is initialized successfully, the tracker or fuser assigns the output `trackID` to the track, set the `UpdateTime` of the track equal to the last step time in the tracker, and synchronizes the data in the input track to the initialized track.

A warning is issued if the tracker or track fuser already maintains the maximum number of tracks specified by the `MaxNumTracks` property of the PHD tracker. In this case, the `trackID` is returned as 0, which indicates a failure to initialize the track.

Note You can only use this syntax if the internal probability hypothesis density filter of the PHD tracker is `gmphd`. If the internal filter is `ggiwphd`, use the second syntax.

`trackID = initializeTrack(tracker, track, filter)` initializes a new track in the PHD tracker using a specified probability hypothesis density filter, `filter`.

Note

- If the internal probability hypothesis density filter used in the tracker is a `ggiwphd` filter, you must use this syntax instead of the first syntax.
-

Examples

Initialize a Track in trackerPHD

Create a PHD tracker after setting up the tracking sensor configuration. Update the tracker with ten detections. The tracker maintains one track.

```
configuration = trackingSensorConfiguration(1);
configuration.ClutterDensity = 1e-7;
configuration.IsValidTime = true;
tracker = trackerPHD('SensorConfigurations', configuration);

dt = 0.1;
for i = 1:10
    detections = objectDetection(i*dt, [5; -5; 0] + 0.2*randn(3, 1));
```

```
    tracker(detections,i*dt);  
end
```

As seen from the NumTracks property, the tracker now maintains one track.

tracker

```
tracker =  
  trackerPHD with properties:  
  
    TrackerIndex: 0  
    SensorConfigurations: {[1x1 trackingSensorConfiguration]}  
    PartitioningFcn: 'partitionDetections'  
    MaxNumSensors: 20  
    MaxNumTracks: 1000  
  
    AssignmentThreshold: 25  
    BirthRate: 1.0000e-03  
    DeathRate: 1.0000e-06  
  
    ExtractionThreshold: 0.5000  
    ConfirmationThreshold: 0.8000  
    DeletionThreshold: 1.0000e-03  
    MergingThreshold: 25  
    LabelingThresholds: [1.1000 1 0.8000]  
  
    StateParameters: [1x1 struct]  
    HasSensorConfigurationsInput: false  
    NumTracks: 1  
    NumConfirmedTracks: 1
```

Create a new track using the objectTrack object.

```
newTrack = objectTrack();
```

Initialize a track in the PHD tracker using the newly created track.

```
trackID = initializeTrack(tracker,newTrack,ggiwphd)  
  
trackID = uint32  
        2
```

As seen from the NumTracks property, the tracker now maintains two tracks.

tracker

```
tracker =  
  trackerPHD with properties:  
  
    TrackerIndex: 0  
    SensorConfigurations: {[1x1 trackingSensorConfiguration]}  
    PartitioningFcn: 'partitionDetections'  
    MaxNumSensors: 20  
    MaxNumTracks: 1000  
  
    AssignmentThreshold: 25  
    BirthRate: 1.0000e-03  
    DeathRate: 1.0000e-06
```

```

    ExtractionThreshold: 0.5000
    ConfirmationThreshold: 0.8000
    DeletionThreshold: 1.0000e-03
    MergingThreshold: 25
    LabelingThresholds: [1.1000 1 0.8000]

    StateParameters: [1x1 struct]
    HasSensorConfigurationsInput: false
    NumTracks: 2
    NumConfirmedTracks: 2

```

Input Arguments

tracker — PHD tracker

trackerPHD object

Probability hypothesis density tracker, specified as a trackerPHD object.

track — New track to be initialized

objectTrack object | structure

New track to be initialized, specified as an objectTrack object or a structure. If specified as a structure, the name, variable type, and data size of the fields of the structure must be the same as the name, variable type, and data size of the corresponding properties of the objectTrack object.

Data Types: struct | object

filter — Probability hypothesis density filter

gmphd | ggiwphd

Probability hypothesis density filter, specified as a gmphd or ggiwphd object.

Output Arguments

trackID — Track identifier

nonnegative integer

Track identifier, returned as a nonnegative integer. trackID is returned as 0 if the track is not initialized successfully.

Example: 2

Extended Capabilities

C/C++ Code Generation

Generate C and C++ code using MATLAB® Coder™.

See Also

trackerPHD

Introduced in R2020a

sensorIndices

List of sensor indices

Syntax

```
indices = sensorIndices(tracker)
```

Description

`indices = sensorIndices(tracker)` returns the `SensorIndex` values of the `trackingSensorConfiguration` objects contained in the `SensorConfigurations` property of the tracker.

Examples

Obtain Sensor Indices of PHD Tracker

Define two `trackingSensorConfiguration` objects.

```
config1 = trackingSensorConfiguration(1);
config2 = trackingSensorConfiguration(2);
```

Create a PHD tracker with `config1` and `config2`.

```
tracker = trackerPHD('SensorConfigurations',{config1;config2});
```

Obtain the sensor indices.

```
indices = sensorIndices(tracker)
```

```
indices = 1x2 uint32 row vector
```

```
    1    2
```

Input Arguments

tracker — PHD tracker

trackerPHD object

PHD tracker, specified as a trackerPHD object.

Output Arguments

indices — Indices of sensors

row-vector of nonnegative integers

Indices of sensors, return as a row-vector of nonnegative integers.

Extended Capabilities

C/C++ Code Generation

Generate C and C++ code using MATLAB® Coder™.

See Also

Introduced in R2020b

trackerJPDA

Joint probabilistic data association tracker

Description

The `trackerJPDA` System object is a tracker capable of processing detections of multiple targets from multiple sensors. The tracker uses joint probabilistic data association to assign detections to each track. The tracker applies a soft assignment where multiple detections can contribute to each track. The tracker initializes, confirms, corrects, predicts (performs coasting), and deletes tracks. Inputs to the tracker are detection reports generated by `objectDetection`, `fusionRadarSensor`, `irSensor`, or `sonarSensor` objects. The tracker estimates the state vector and state estimate error covariance matrix for each track. Each detection is assigned to at least one track. If the detection cannot be assigned to any existing track, the tracker creates a new track.

Any new track starts in a *tentative* state. If enough detections are assigned to a tentative track, its status changes to *confirmed* (see the `ConfirmationThreshold` property). If the detection already has a known classification (i.e., the `ObjectClassID` field of the returned track is nonzero), that corresponding track is confirmed immediately. When a track is confirmed, the tracker considers the track to represent a physical object. If detections are not assigned to the track within a specifiable number of updates, the track is deleted.

To track targets using this object:

- 1 Create the `trackerJPDA` object and set its properties.
- 2 Call the object with arguments, as if it were a function.

To learn more about how System objects work, see [What Are System Objects?](#).

Creation

Syntax

```
tracker = trackerJPDA
tracker = trackerJPDA(Name,Value)
```

Description

`tracker = trackerJPDA` creates a `trackerJPDA` System object with default property values.

`tracker = trackerJPDA(Name,Value)` sets properties for the tracker using one or more name-value pairs. For example, `trackerJPDA('FilterInitializationFcn',@initcvukf,'MaxNumTracks',100)` creates a multi-object tracker that uses a constant-velocity, unscented Kalman filter and allows a maximum of 100 tracks. Enclose each property name in quotes.

Properties

Unless otherwise indicated, properties are *nontunable*, which means you cannot change their values after calling the object. Objects lock when you call them, and the `release` function unlocks them.

If a property is *tunable*, you can change its value at any time.

For more information on changing property values, see *System Design in MATLAB Using System Objects*.

TrackerIndex — Unique tracker identifier

0 (default) | nonnegative integer

Unique tracker identifier, specified as a nonnegative integer. This property is used as the `SourceIndex` in the tracker outputs, and distinguishes tracks that come from different trackers in a multiple-tracker system. You must specify this property as a positive integer to use the track outputs as inputs to a track fuser.

Example: 1

FilterInitializationFcn — Filter initialization function

@initcvkf (default) | function handle | character vector

Filter initialization function, specified as a function handle or as a character vector containing the name of a valid filter initialization function. The tracker uses a filter initialization function when creating new tracks.

Sensor Fusion and Tracking Toolbox supplies many initialization functions that you can use to specify `FilterInitializationFcn` for a `trackerJPDA` object.

Initialization Function	Function Definition
<code>initcvkf</code>	Initialize constant-velocity linear Kalman filter.
<code>initcakf</code>	Initialize constant-acceleration linear Kalman filter.
<code>initcvabf</code>	Initialize constant-velocity alpha-beta filter
<code>initcaabf</code>	Initialize constant-acceleration alpha-beta filter
<code>initcvekf</code>	Initialize constant-velocity extended Kalman filter.
<code>initcaekf</code>	Initialize constant-acceleration extended Kalman filter.
<code>initrpekf</code>	Initialize constant-velocity range-parametrized extended Kalman filter.
<code>initapekf</code>	Initialize constant-velocity angle-parametrized extended Kalman filter.
<code>initctekf</code>	Initialize constant-turn-rate extended Kalman filter.
<code>initcackf</code>	Initialize constant-acceleration cubature filter.
<code>initctckf</code>	Initialize constant-turn-rate cubature filter.
<code>initcvckf</code>	Initialize constant-velocity cubature filter.

Initialization Function	Function Definition
<code>initcvukf</code>	Initialize constant-velocity unscented Kalman filter.
<code>initcaukf</code>	Initialize constant-acceleration unscented Kalman filter.
<code>initctukf</code>	Initialize constant-turn-rate unscented Kalman filter.
<code>initcvmscekf</code>	Initialize constant-velocity extended Kalman filter in modified spherical coordinates.
<code>initekfimm</code>	Initialize tracking IMM filter.

You can also write your own initialization function using the following syntax:

```
filter = filterInitializationFcn(detection)
```

The input to this function is a detection report like those created by `objectDetection`. The output of this function must be a filter object: `trackingKF`, `trackingEKF`, `trackingUKF`, `trackingCKF`, `trackingGSF`, `trackingIMM`, `trackingMSCEKF`, or `trackingABF`.

For guidance in writing this function, use the `type` command to examine the details of built-in MATLAB functions. For example:

```
type initcvekf
```

Note `trackerJPDA` does not accept all filter initialization functions in Sensor Fusion and Tracking Toolbox. The full list of filter initialization functions available in Sensor Fusion and Tracking Toolbox are given in the **Initialization** section of “Estimation Filters”.

Data Types: `function_handle` | `char`

MaxNumEvents — Value of k for k-best JPDA

`Inf` (default) | positive integer

Value of `k` for k-best JPDA, specified as a positive integer. This property defines the maximum number of feasible joint events for the track and detection association of each cluster. Setting this property to a finite value enables you to run a k-best JPDA tracker, which generates a maximum of `k` events per cluster.

Data Types: `single` | `double`

EventGenerationFcn — Feasible joint events generation function

`@jpdEvents` (default) | function handle | character vector

Feasible joint events generation function, specified as a function handle or as a character vector containing the name of a feasible joint events generation function. A generation function generates feasible joint event matrices from admissible events (usually given by a validation matrix or a likelihood matrix) of a scenario. For details, see `jpadEvents`.

You can also write your own generation function.

- If the `MaxNumEvents` property is set to `Inf`, the function must have the following syntax:

```
FJE = myfunction(ValidationMatrix)
```

The input and out of this function must exactly follow the formats used in `jpdaEvents`.

- If the `MaxNumEvents` property is set to a finite value, the function must have the following syntax:

```
[FJE,FJEProbs] = myfunction(likelihoodMatrix,k)
```

The input and out of this function must exactly follow the formats used in `jpdaEvents`.

For guidance in writing this function, use the `type` command to examine the details of `jpdaEvents`:

```
type jpdaEvents
```

Example: `@myfunction` or `'myfunction'`

Data Types: `function_handle` | `char`

MaxNumTracks — Maximum number of tracks

100 (default) | positive integer

Maximum number of tracks that the tracker can maintain, specified as a positive integer.

Data Types: `single` | `double`

MaxNumSensors — Maximum number of sensors

20 (default) | positive integer

Maximum number of sensors that can be connected to the tracker, specified as a positive integer. `MaxNumSensors` must be greater than or equal to the largest value of `SensorIndex` found in all the detections used to update the tracker. `SensorIndex` is a property of an `objectDetection` object. The `MaxNumSensors` property determines how many sets of `ObjectAttributes` each track can have.

Data Types: `single` | `double`

OOSMHandling — Handle out-of-sequence measurement (OOSM)

'Terminate' (default) | 'Neglect'

Handle out-of-sequence measurement (OOSM), specified as `'Terminate'` or `'Neglect'`. Each detection has a timestamp associated with it, t_d , and the tracker has its own timestamp, t_t , which is updated in each call. The tracker considers a measurement as an OOSM if $t_d < t_t$.

When the property is specified as

- `'Terminate'` — The tracker stops running when it encounters any out-of-sequence measurements.
- `'Neglect'` — The tracker neglects any out-of-sequence measurements and continues to run.

Note The tracker requires all input “detections” on page 3-0 that share the same `SensorIndex` have their `Time` differences bounded by the “`TimeTolerance`” on page 3-0 property. When you set the `OOSMHandling` property to `'Neglect'`, you must make sure that the out-of-sequence detections have timestamps strictly less than the previous timestamp when running the tracker.

Tunable: Yes

StateParameters — Parameters of track state reference frame

`struct([])` (default) | `struct` array

Parameters of the track state reference frame, specified as a structure or a structure array. The tracker passes its `StateParameters` property values to the `StateParameters` property of the generated tracks. You can use these parameters to define the reference frame in which the track is reported or other desirable attributes of the generated tracks.

For example, you can use the following structure to define a rectangular reference frame whose origin position is at `[10 10 0]` meters and whose origin velocity is `[2 -2 0]` meters per second with respect to the scenario frame.

Field Name	Value
Frame	"Rectangular"
Position	[10 10 0]
Velocity	[2 -2 0]

Tunable: Yes

Data Types: `struct`

AssignmentThreshold — Detection assignment threshold

`30*[1 Inf]` (default) | positive scalar | 1-by-2 vector of positive values

Detection assignment threshold (or gating threshold), specified as a positive scalar or 1-by-2 vector of $[C_1, C_2]$, where $C_1 \leq C_2$. If specified as a scalar, the specified value, *val*, is expanded to $[val, Inf]$.

Initially, the tracker executes a coarse estimation for the normalized distance between all the tracks and detections. The tracker only calculates the accurate normalized distance for the combinations whose coarse normalized distance is less than C_2 . Also, the tracker can only assign a detection to a track if the accurate normalized distance between them is less than C_1 . See the `distance` function used with tracking filters (such as `trackingCKF` and `trackingEKF`) for explanation of the distance calculation.

Tips:

- Increase the value of C_2 if there are track and detection combinations that should be calculated for assignment but are not. Decrease this value if cost calculation takes too much time.
- Increase the value of C_1 if there are detections that should be assigned to tracks but are not. Decrease this value if there are detections that are assigned to tracks they should not be assigned to (too far away).

DetectionProbability — Probability of detection

0.9 (default) | scalar in the range [0,1]

Probability of detection, specified as a scalar in the range [0,1]. This property is used in calculations of the marginal posterior probabilities of association and the probability of track existence when initializing and updating a track.

Example: 0.85

Data Types: `single` | `double`

InitializationThreshold — Threshold to initialize a track

0 (default) | scalar in the range [0,1]

The probability threshold to initialize a new track, specified as a scalar in the range [0,1]. If the probabilities of associating a detection with any of the existing tracks are all smaller than `InitializationThreshold`, the detection will be used to initialize a new track. This allows detections that are within the validation gate of a track but have an association probability lower than the initialization threshold to spawn a new track.

Example: `0.1`

Data Types: `single` | `double`

TrackLogic – Track confirmation and deletion logic type

'History' (default) | 'Integrated'

Confirmation and deletion logic type, specified as:

- 'History' - Track confirmation and deletion is based on the number of times the track has been assigned to a detection in the latest tracker updates.
- 'Integrated' - Track confirmation and deletion is based on the probability of track existence, which is integrated in the assignment function.

ConfirmationThreshold – Threshold for track confirmation

scalar | 1-by-2 vector

Threshold for track confirmation, specified as a scalar or a 1-by-2 vector. The threshold depends on the type of track confirmation and deletion logic you set with the `TrackLogic` property:

- 'History' - Specify the confirmation threshold as 1-by-2 vector $[M\ N]$. A track is confirmed if it recorded at least M hits in the last N updates. The `trackerJPDA` registers a hit on a track's history logic according to the `HitMissThreshold`. The default value is $[2\ 3]$.
- 'Integrated' - Specify the confirmation threshold as a scalar. A track is confirmed if its probability of existence is greater than or equal to the confirmation threshold. The default value is `0.95`.

Data Types: `single` | `double`

DeletionThreshold – Threshold for track deletion

scalar | real-valued 1-by-2 vector

Threshold for track deletion, specified as a scalar or a real-valued 1-by-2 vector. The threshold depends on the type of track confirmation and deletion logic you set with the `TrackLogic` property:

- 'History' - Specify the confirmation threshold as $[P\ R]$. If, in P of the last R tracker updates, a confirmed track is not assigned to any detection that has a likelihood greater than the `HitMissThreshold` property, then that track is deleted. The default value is $[5\ 5]$.
- 'Integrated' - Specify the deletion threshold as a scalar. A track is deleted if its probability of existence drops below the threshold. The default value is `0.1`.

Example: `0.2` or $[5,6]$

Data Types: `single` | `double`

HitMissThreshold – Threshold for registering hit or miss

`0.2` (default) | scalar in the range [0,1]

Threshold for registering a hit or miss, specified as a scalar in the range [0,1]. The track history logic will register a miss and the track will be coasted if the sum of the marginal probabilities of assignments is below the `HitMissThreshold`. Otherwise, the track history logic will register a hit.

Example: 0.3

Dependencies

To enable this argument, set the `TrackLogic` property to 'History'.

Data Types: single | double

ClutterDensity — Spatial density of clutter measurements

1e-6 (default) | positive scalar

Spatial density of clutter measurements, specified as a positive scalar. The clutter density describes the expected number of false positive detections per unit volume. It is used as the parameter of a Poisson clutter model. When `TrackLogic` is set to 'Integrated', `ClutterDensity` is also used in calculating the initial probability of track existence.

Example: 1e-5

Data Types: single | double

NewTargetDensity — Spatial density of new targets

1e-5 (default) | positive scalar

Spatial density of new targets, specified as a positive scalar. The new target density describes the expected number of new tracks per unit volume in the measurement space. It is used in calculating the probability of track existence during track initialization.

Example: 1e-3

Dependencies

To enable this argument, set the `TrackLogic` property to 'Integrated'.

Data Types: single | double

DeathRate — Time rate of target deaths

0.01 (default) | scalar in the range [0,1]

Time rate of target deaths, specified as a scalar in the range [0,1]. `DeathRate` describes the probability with which true targets disappear. It is related to the propagation of the probability of track existence (*PTE*):

$$PTE(t + \delta t) = (1 - DeathRate)^{\delta t} PTE(t)$$

where δt is the time interval since the previous update time t .

Dependencies

To enable this argument, set the `TrackLogic` property to 'Integrated'.

Data Types: single | double

InitialExistenceProbability — Initial probability of track existence

0.9 (default) | scalar in the range [0,1]

This property is read-only.

Initial probability of track existence, specified as a scalar in the range [0,1] and calculated as $\text{InitialExistenceProbability} = \frac{\text{NewTargetDensity} * \text{DetectionProbability}}{(\text{ClutterDensity} + \text{NewTargetDensity} * \text{DetectionProbability})}$.

Dependencies

To enable this property, set the `TrackLogic` property to 'Integrated'. When the `TrackLogic` property is set to 'History', this property is not available.

Data Types: `single` | `double`

HasCostMatrixInput — Enable cost matrix input

`false` (default) | `true`

Enable a cost matrix, specified as `false` or `true`. If `true`, you can provide an assignment cost matrix as an input argument when calling the object.

Data Types: `logical`

HasDetectableTrackIDsInput — Enable input of detectable track IDs

`false` (default) | `true`

Enable the input of detectable track IDs at each object update, specified as `false` or `true`. Set this property to `true` if you want to provide a list of detectable track IDs. This list informs the tracker of all tracks that the sensors are expected to detect and, optionally, the probability of detection for each track.

Data Types: `logical`

NumTracks — Number of tracks maintained by tracker

nonnegative integer

This property is read-only.

Number of tracks maintained by the tracker, returned as a nonnegative integer.

Data Types: `single` | `double`

NumConfirmedTracks — Number of confirmed tracks

nonnegative integer

This property is read-only.

Number of confirmed tracks, returned as a nonnegative integer. If the `IsConfirmed` field of an output track structure is `true`, the track is confirmed.

Data Types: `single` | `double`

TimeTolerance — Absolute time tolerance between detections

`1e-5` (default) | positive scalar

Absolute time tolerance between detections for the same sensor, specified as a positive scalar. Ideally, `trackerJPDA` expects detections from a sensor to have identical time stamps. However, if the time stamps differences between detections of a sensor are within the margin specified by `TimeTolerance`, these detections will be used to update the track estimate based on the average time of these detections.

Data Types: double

Usage

To process detections and update tracks, call the tracker with arguments, as if it were a function (described here).

Syntax

```
confirmedTracks = tracker(detections,time)
confirmedTracks = tracker(detections,time,costMatrix)
confirmedTracks = tracker( ___,detectableTrackIDs)
[confirmedTracks,tentativeTracks,allTracks] = tracker( ___ )
[confirmedTracks,tentativeTracks,allTracks,analysisInformation] = tracker( ___ )
```

Description

`confirmedTracks = tracker(detections,time)` returns a list of confirmed tracks that are updated from a list of detections at the update time. Confirmed tracks are corrected and predicted to the update time, `time`.

`confirmedTracks = tracker(detections,time,costMatrix)` also specifies a cost matrix.

To enable this syntax, set the `HasCostMatrixInput` property to `true`.

`confirmedTracks = tracker(___,detectableTrackIDs)` also specifies a list of expected detectable tracks given by `detectableTrackIDs`. This argument can be used with any of the previous input syntaxes.

To enable this syntax, set the `HasDetectableTrackIDsInput` property to `true`.

`[confirmedTracks,tentativeTracks,allTracks] = tracker(___)` also returns a list of tentative tracks and a list of all tracks. You can use any of the input arguments in the previous syntaxes.

`[confirmedTracks,tentativeTracks,allTracks,analysisInformation] = tracker(___)` also returns analysis information that can be used for track analysis. You can use any of the input arguments in the previous syntaxes.

Input Arguments

detections — Detection list

cell array of `objectDetection` objects

Detection list, specified as a cell array of `objectDetection` objects. The `Time` property value of each `objectDetection` object must be less than or equal to the current update time, `time`, and greater than the previous time value used to update the tracker. Also, the `Time` differences between different `objectDetection` objects in the cell array do not need to be equal.

time — Time of update

scalar

Time of update, specified as a scalar. The tracker updates all tracks to this time. Units are in seconds.

`time` must be greater than or equal to the largest `Time` property value of the `objectDetection` objects in the input `detections` list. `time` must increase in value with each update to the tracker.

Data Types: `single` | `double`

costMatrix — Cost matrix

real-valued M -by- N matrix

Cost matrix, specified as a real-valued M -by- N matrix, where M is the number of existing tracks in the previous update, and N is the number of current detections. The cost matrix rows must be in the same order as the list of tracks, and the columns must be in the same order as the list of detections. Obtain the correct order of the list of tracks from the third output argument, `allTracks`, when the tracker is updated.

At the first update of the tracker or when the tracker has no previous tracks, specify the cost matrix to be empty with a size of `[0, numDetections]`. Note that the cost must be given so that lower costs indicate a higher likelihood of assigning a detection to a track. To prevent certain detections from being assigned to certain tracks, you can set the appropriate cost matrix entry to `Inf`.

Dependencies

To enable this argument, set the `HasCostMatrixInput` property to `true`.

Data Types: `double` | `single`

detectableTrackIDs — Detectable track IDs

real-valued M -by-1 vector | real-valued M -by-2 matrix

Detectable track IDs, specified as a real-valued M -by-1 vector or M -by-2 matrix. Detectable tracks are tracks that the sensors expect to detect. The first column of the matrix contains a list of track IDs that the sensors report as detectable. The optional second column allows you to add the detection probability for each track.

Tracks whose identifiers are not included in `detectableTrackIDs` are considered undetectable. In this case, the track deletion logic does not count the lack of detection for that track as a missed detection for track deletion purposes.

Dependencies

To enable this input argument, set the `detectableTrackIDs` property to `true`.

Data Types: `single` | `double`

Output Arguments

confirmedTracks — Confirmed tracks

array of `objectTrack` objects | array of structures

Confirmed tracks, returned as an array of `objectTrack` objects in MATLAB, and returned as an array of structures in code generation. In code generation, the field names of the returned structure are same with the property names of `objectTrack`.

A track is confirmed if it satisfies the confirmation threshold specified in the `ConfirmationThreshold` property. In that case, the `IsConfirmed` property of the object or field of the structure is `true`.

Data Types: `struct` | `object`

tentativeTracks – Tentative tracksarray of `objectTrack` objects | array of structures

Tentative tracks, returned as an array of `objectTrack` objects in MATLAB, and returned as an array of structures in code generation. In code generation, the field names of the returned structure are same with the property names of `objectTrack`.

A track is tentative if it does not satisfy the confirmation threshold specified in the `ConfirmationThreshold` property. In that case, the `IsConfirmed` property of the object or field of the structure is `false`.

Data Types: `struct` | `object`**allTracks – All tracks**array of `objectTrack` objects | array of structures

All tracks, returned as an array of `objectTrack` objects in MATLAB, and returned as an array of structures in code generation. In code generation, the field names of the returned structure are same with the property names of `objectTrack`. All tracks consists of confirmed and tentative tracks.

Data Types: `struct` | `object`**analysisInformation – Additional information for analyzing track updates**

structure

Additional information for analyzing track updates, returned as a structure. The fields of this structure are:

Field	Description
<code>TrackIDsAtStepBeginning</code>	Track IDs when step began.
<code>CostMatrix</code>	Cost matrix for assignment.
<code>UnassignedTracks</code>	IDs of unassigned tracks.
<code>UnassignedDetections</code>	Indices of unassigned detections in the <code>detections</code> input.
<code>Clusters</code>	Cell array of cluster reports.
<code>InitiatedTrackIDs</code>	IDs of tracks initiated during the step.
<code>DeletedTrackIDs</code>	IDs of tracks deleted during the step.
<code>TrackIDsAtStepEnd</code>	Track IDs when the step ended.

The `Clusters` field can include multiple cluster reports. Each cluster report is a structure containing:

Field	Description
<code>DetectionIndices</code>	Indices of clustered detections.
<code>TrackIDs</code>	Track IDs of clustered tracks.
<code>ValidationMatrix</code>	Validation matrix of the cluster. See <code>jpadEvents</code> for more details.
<code>SensorIndex</code>	Index of the originating sensor of the clustered detections.

TimeStamp	Mean time stamp of clustered detections.
MarginalProbabilities	Matrix of marginal posterior joint association probabilities.

Data Types: struct

Object Functions

To use an object function, specify the System object as the first input argument. For example, to release system resources of a System object named `obj`, use this syntax:

```
release(obj)
```

Specific to trackerJPDA

<code>predictTracksToTime</code>	Predict track state
<code>getTrackFilterProperties</code>	Obtain track filter properties
<code>setTrackFilterProperties</code>	Set track filter properties
<code>initializeTrack</code>	Initialize new track
<code>deleteTrack</code>	Delete existing track

Common to All System Objects

<code>step</code>	Run System object algorithm
<code>release</code>	Release resources and allow changes to System object property values and input characteristics
<code>isLocked</code>	Determine if System object is in use
<code>clone</code>	Create duplicate System object
<code>reset</code>	Reset internal states of System object

Examples

Track Two Objects Using trackerJPDA

Construct a `trackerJPDA` object with a default constant velocity Extended Kalman Filter and 'History' track logic. Set `AssignmentThreshold` to 100 to allow tracks to be jointly associated.

```
tracker = trackerJPDA('TrackLogic','History', 'AssignmentThreshold',100,...
    'ConfirmationThreshold', [4 5], ...
    'DeletionThreshold', [10 10]);
```

Specify the true initial positions and velocities of the two objects.

```
pos_true = [0 0 ; 40 -40 ; 0 0];
V_true = 5*[cosd(-30) cosd(30) ; sind(-30) sind(30) ;0 0];
```

Create a theater plot to visualize tracks and detections.

```
tp = theaterPlot('XLimits',[-1 150],'YLimits',[-50 50]);
trackP = trackPlotter(tp,'DisplayName','Tracks','MarkerFaceColor','g','HistoryDepth',0);
detectionP = detectionPlotter(tp,'DisplayName','Detections','MarkerFaceColor','r');
```

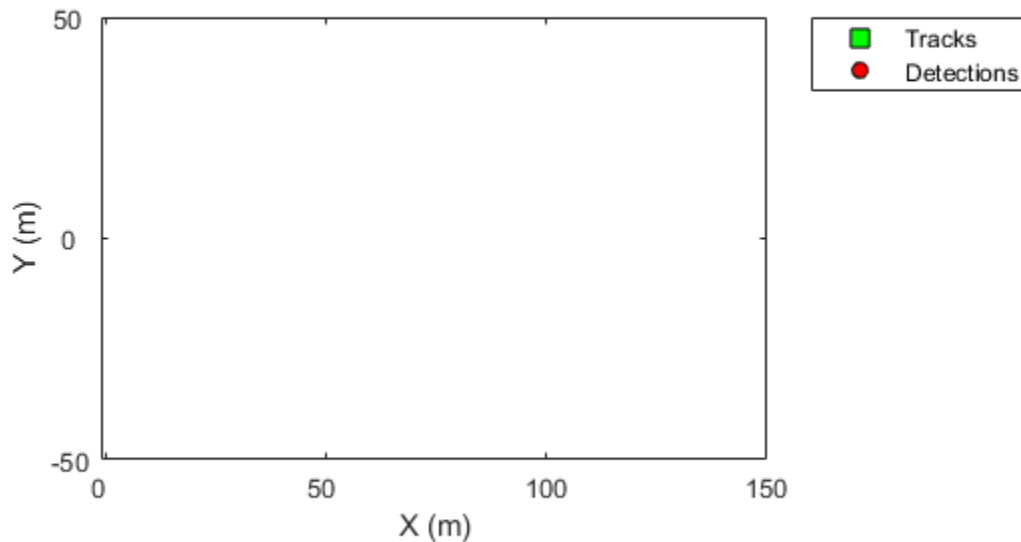

To obtain the position and velocity, create position and velocity selectors.

```
positionSelector = [1 0 0 0 0 0; 0 0 1 0 0 0; 0 0 0 0 0 0]; % [x, y, 0]
velocitySelector = [0 1 0 0 0 0; 0 0 0 1 0 0; 0 0 0 0 0 0]; % [vx, vy, 0]
```

Update the tracker with detections, display cost and marginal probability of association information, and visualize tracks with detections.

```
dt = 0.2;
for time = 0:dt:30
    % Update the true positions of objects.
    pos_true = pos_true + V_true*dt;

    % Create detections of the two objects with noise.
    detection(1) = objectDetection(time,pos_true(:,1)+1*randn(3,1));
    detection(2) = objectDetection(time,pos_true(:,2)+1*randn(3,1));

    % Step the tracker through time with the detections.
    [confirmed,tentative,alltracks,info] = tracker(detection,time);

    % Extract position, velocity and label info.
    [pos,cov] = getTrackPositions(confirmed,positionSelector);
    vel = getTrackVelocities(confirmed,velocitySelector);
    meas = cat(2,detection.Measurement);
    measCov = cat(3,detection.MeasurementNoise);

    % Update the plot if there are any tracks.
    if numel(confirmed)>0
```

```

        labels = arrayfun(@(x)num2str([x.TrackID]),confirmed,'UniformOutput',false);
        trackP.plotTrack(pos,vel,cov,labels);
    end
    detectionP.plotDetection(meas',measCov);
    drawnow;

    % Display the cost and marginal probability of distribution every eight
    % seconds.
    if time>0 && mod(time,8) == 0
        disp(['At time t = ' num2str(time) ' seconds,']);
        disp('The cost of assignment was: ');
        disp(info.CostMatrix);
        disp(['Number of clusters: ' num2str(numel(info.Clusters))]);
        if numel(info.Clusters) == 1
            disp('The two tracks were in the same cluster.')
            disp('Marginal probabilities of association:')
            disp(info.Clusters{1}.MarginalProbabilities)
        end
        disp('-----')
    end
end
end

```

At time t = 8 seconds,

The cost of assignment was:

1.0e+03 *

0.0020	1.1523
1.2277	0.0053

Number of clusters: 2

At time t = 16 seconds,

The cost of assignment was:

1.3968	4.5123
2.0747	1.9558

Number of clusters: 1

The two tracks were in the same cluster.

Marginal probabilities of association:

0.8344	0.1656
0.1656	0.8344
0.0000	0.0000

At time t = 24 seconds,

The cost of assignment was:

1.0e+03 *

```

0.0018    1.2962
1.2664    0.0013

```

Number of clusters: 2

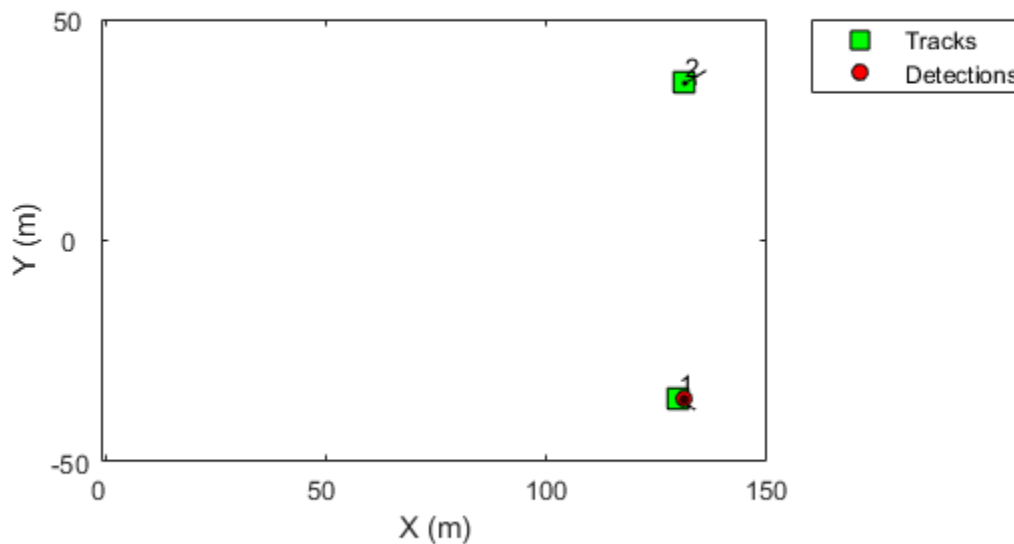

Algorithms

Tracker Logic Flow

When a JPDA tracker processes detections, track creation and management follow these steps.

- 1 The tracker divides detections into multiple groups by originating sensor.
- 2 For each sensor:
 - a The tracker calculates the distances from detections to existing tracks and forms a `costMatrix`.
 - b The tracker creates a validation matrix based on the assignment threshold (or gate threshold) of the existing tracks. A validation matrix is a binary matrix listing all possible detections-to-track associations. For details, see “Feasible Joint Events” on page 3-552.
 - c Tracks and detections are then separated into clusters. A cluster can contain one track or multiple tracks if these tracks share common detections within their validation gates. A validation gate is a spatial boundary, in which the predicted detection of the track has a high likelihood to fall. For details, see “Feasible Joint Events” on page 3-552.

- 3 Update all clusters following the order of the mean detection time stamp within the cluster. For each cluster, the tracker:
 - a Generates all feasible joint events. For details, see `jpdaEvents`.
 - b Calculates the posterior probability of each joint event.
 - c Calculates the marginal probability of each individual detection-track pair in the cluster.
 - d Reports weak detections. Weak detections are the detections that are within the validation gate of at least one track, but have probability association to all tracks less than the `InitializationThreshold`.
 - e Updates tracks in the cluster using `correctjpda`.
- 4 Unassigned detections (these are not in any cluster) and weak detections spawn new tracks.
- 5 The tracker checks all tracks for deletion. Tracks are deleted based on the number of scans without association using 'History' logic or based on their probability of existence using 'Integrated' track logic.
- 6 All tracks are predicted to the latest time value (either the time input if provided, or the latest mean cluster time stamp).

Feasible Joint Events

In the typical workflow for a tracking system, the tracker needs to determine if a detection can be associated with any of the existing tracks. If the tracker only maintains one track, the assignment can be done by evaluating the validation gate around the predicted measurement and deciding if the measurement falls within the *validation gate*. In the measurement space, the validation gate is a spatial boundary, such as a 2-D ellipse or a 3-D ellipsoid, centered at the predicted measurement. The validation gate is defined using the probability information (state estimation and covariance, for example) of the existing track, such that the correct or ideal detections have high likelihood (97% probability, for example) of falling within this validation gate.

However, if a tracker maintains multiple tracks, the data association process becomes more complicated, because one detection can fall within the validation gates of multiple tracks. For example, in the following figure, tracks T_1 and T_2 are actively maintained in the tracker, and each of them has its own validation gate. Since the detection D_2 is in the intersection of the validation gates of both T_1 and T_2 , the two tracks (T_1 and T_2) are connected and form a *cluster*. A cluster is a set of connected tracks and their associated detections.

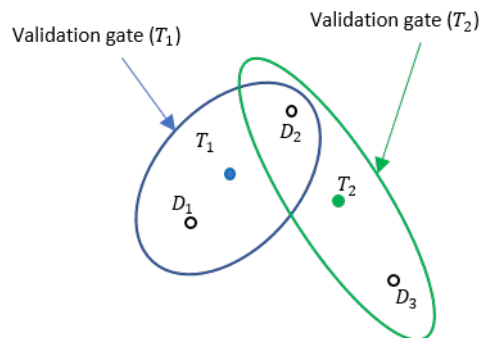

To represent the association relationship in a cluster, the validation matrix is commonly used. Each row of the validation matrix corresponds to a detection while each column corresponds to a track. To account for the eventuality of each detection being clutter, a first column is added and usually referred to as "Track 0" or T_0 . If detection D_i is inside the validation gate of track T_j , then the $(j, i+1)$

entry of the validation matrix is 1. Otherwise, it is zero. For the cluster shown in the figure, the validation matrix Ω is

$$\Omega = \begin{bmatrix} 1 & 1 & 0 \\ 1 & 1 & 1 \\ 1 & 0 & 1 \end{bmatrix}$$

Note that all the elements in the first column of Ω are 1, because any detection can be clutter or false alarm. One important step in the logic of joint probabilistic data association (JPDA) is to obtain all the feasible independent joint events in a cluster. Two assumptions for the feasible joint events are:

- A detection cannot be emitted by more than one track.
- A track cannot be detected more than once by the sensor during a single scan.

Based on these two assumptions, feasible joint events (FJEs) can be formulated. Each FJE is mapped to an FJE matrix Ω_p from the initial validation matrix Ω . For example, with the validation matrix Ω , eight FJE matrices can be obtained:

$$\begin{aligned} \Omega_1 &= \begin{bmatrix} 1 & 0 & 0 \\ 1 & 0 & 0 \\ 1 & 0 & 0 \end{bmatrix}, \quad \Omega_2 = \begin{bmatrix} 0 & 1 & 0 \\ 1 & 0 & 0 \\ 1 & 0 & 0 \end{bmatrix}, \quad \Omega_3 = \begin{bmatrix} 1 & 0 & 0 \\ 0 & 1 & 0 \\ 1 & 0 & 0 \end{bmatrix}, \quad \Omega_4 = \begin{bmatrix} 1 & 0 & 0 \\ 0 & 0 & 1 \\ 1 & 0 & 0 \end{bmatrix} \\ \Omega_5 &= \begin{bmatrix} 0 & 1 & 0 \\ 0 & 0 & 1 \\ 1 & 0 & 0 \end{bmatrix}, \quad \Omega_6 = \begin{bmatrix} 1 & 0 & 0 \\ 1 & 0 & 0 \\ 0 & 0 & 1 \end{bmatrix}, \quad \Omega_7 = \begin{bmatrix} 0 & 1 & 0 \\ 1 & 0 & 0 \\ 0 & 0 & 1 \end{bmatrix}, \quad \Omega_8 = \begin{bmatrix} 1 & 0 & 0 \\ 0 & 1 & 0 \\ 0 & 0 & 1 \end{bmatrix} \end{aligned}$$

As a direct consequence of the two assumptions, the Ω_p matrices have exactly one "1" value per row. Also, except for the first column which maps to clutter, there can be at most one "1" per column. When the number of connected tracks grows in a cluster, the number of FJE increases rapidly. The `jpdaEvents` function uses an efficient depth-first search algorithm to generate all the feasible joint event matrices.

References

- [1] Fortmann, T., Y. Bar-Shalom, and M. Scheffe. "Sonar Tracking of Multiple Targets Using Joint Probabilistic Data Association." *IEEE Journal of Ocean Engineering*. Vol. 8, Number 3, 1983, pp. 173-184.
- [2] Musicki, D., and R. Evans. "Joint Integrated Probabilistic Data Association: JIPDA." *IEEE transactions on Aerospace and Electronic Systems*. Vol. 40, Number 3, 2004, pp 1093-1099.

Extended Capabilities

C/C++ Code Generation

Generate C and C++ code using MATLAB® Coder™.

Usage notes and limitations:

- See "System Objects in MATLAB Code Generation" (MATLAB Coder).
- All the detections used with a multi-object tracker must have properties with the same sizes and types.

- If you use the `ObjectAttributes` field within an `objectDetection` object, you must specify this field as a cell containing a structure. The structure for all detections must have the same fields, and the values in these fields must always have the same size and type. The form of the structure cannot change during simulation.
- If `ObjectAttributes` are contained in the detection, the `SensorIndex` value of the detection cannot be greater than 10.
- The first update to the multi-object tracker must contain at least one detection.

See Also

Functions

`correctjpda` | `getTrackPositions` | `getTrackVelocities` | `jpdaEvents` | `predictTracksToTime`

Objects

`objectDetection` | `objectTrack` | `staticDetectionFuser` | `trackHistoryLogic` | `trackerGNN` | `trackerTOMHT` | `trackingABF` | `trackingCKF` | `trackingEKF` | `trackingIMM` | `trackingKF` | `trackingUKF`

Introduced in R2019a

trackingArchitecture

Tracking system-of-system architecture

Description

The `trackingArchitecture` System object enables you to systematically model the architecture of a tracking system consisting of trackers and track fusers.

To build and run a tracking architecture:

- 1 Create the `trackingArchitecture` object and set its properties.
- 2 Call the object with arguments, as if it were a function.

To learn more about how System objects work, see [What Are System Objects?](#).

Creation

Syntax

```
ta = trackingArchitecture
```

Description

`ta = trackingArchitecture` creates a `trackingArchitecture` System object that enables you to design a tracking system-of-system composed of sensors, trackers, and track fusers.

- Use the `addTracker` function to add trackers to the architecture and connect the added tracker with architecture inputs.
- Use the `addTrackFuser` function to add track fusers to the architecture and connect the added track fuser with trackers and architecture inputs.
- Use the `summary` function to list all the trackers and fusers in the architecture and show how they are connected with architecture inputs and outputs.
- Use the `show` function to visualize the architecture.

Properties

Unless otherwise indicated, properties are *nontunable*, which means you cannot change their values after calling the object. Objects lock when you call them, and the `release` function unlocks them.

If a property is *tunable*, you can change its value at any time.

For more information on changing property values, see [System Design in MATLAB Using System Objects](#).

Trackers — List of trackers

cell array of trackers

List of trackers, specified as a cell array of trackers. Each cell element is one of these tracker objects:

- `trackerGNN`
- `trackerJPDA`
- `trackerTOMHT`
- `trackerPHD`

You can also use a customized tracker inheriting from the `fusion.trackingArchitecture.Tracker` class.

TrackFusers — List of track fusers

cell array of `trackFuser` objects

List of track fusers, specified as a cell array of `trackFuser` objects.

You can also use a customized track fuser inheriting from the `fusion.trackingArchitecture.TrackFuser` class.

Usage

Syntax

```
[tracks1,...,tracksN] = ta(detections,sourceTracks,time)
```

Description

`[tracks1,...,tracksN] = ta(detections,sourceTracks,time)` runs the `trackingArchitecture` object, `ta`, and returns the confirmed tracks.

Input Arguments

detections — Detection list

array of `objectDetection` objects | cell array of `objectDetection` objects | array of object detection structures

Detection list, specified as an array of `objectDetection` objects, a cell array of `objectDetection` objects, or an array of structures. If specified as structures, the field names of each structure must be the same as the property names of the `objectDetection` object. The architecture routes a detection to the tracker whose corresponding `ArchitectureInputs` values in the architecture contain the `SensorIndex` value of the detection.

sourceTracks — Source tracks

array of `objectTrack` objects | array of structures

Source tracks, specified as an array of `objectTrack` objects or an array of structures. If specified as structures, the field names of each structure must be the same as the property names of the `objectTrack` object. The architecture routes a source track to the fuser whose corresponding `FuserInputs` values in the architecture contain the `SourceIndex` value of the track.

Use the `SourceConfigurations` property of the `trackFuser` to specify the input sources of the fuser.

time — Time of update

scalar

Time of update, specified as a scalar. The architecture updates all trackers and fusers to this time. Units are in seconds.

`time` must be greater than or equal to the largest `Time` value in the arrays of `detections` and `sourceTracks` inputs. `time` must increase in value with each update to the architecture.

Output Arguments**tracksN — Tracks from the Nth architecture output**array of `objectTrack` objects | array of structures

Tracks from the Nth architecture output, returned as an array of `objectTrack` objects in MATLAB, and returned as an array of structures in code generation. In code generation, the field names of the returned structure are the same as the property names of `objectTrack`. `tracksN` is generated from the tracker or track fuser whose corresponding `ArchitectureOutput` value in the architecture is equal to `N`.

Data Types: `struct` | `object`

Object Functions

To use an object function, specify the `System` object as the first input argument. For example, to release system resources of a `System` object named `obj`, use this syntax:

```
release(obj)
```

Specific to trackingArchitecture

<code>addTracker</code>	Add tracker to tracking architecture
<code>addTrackFuser</code>	Add track fuser to tracking architecture
<code>summary</code>	Display tabular summary of tracking architecture
<code>show</code>	Show tracking architecture in figure

Common to All System Objects

<code>step</code>	Run <code>System</code> object algorithm
<code>release</code>	Release resources and allow changes to <code>System</code> object property values and input characteristics
<code>isLocked</code>	Determine if <code>System</code> object is in use
<code>clone</code>	Create duplicate <code>System</code> object
<code>reset</code>	Reset internal states of <code>System</code> object

Examples**Create and Show trackingArchitecture**

Create a tracking architecture.

```
ta = trackingArchitecture;
```

Create a `trackerGNN` object. The tracker takes detection inputs from sensors 1 and 2. Add the tracker to the tracking architecture.

```
tracker1 = trackerGNN('TrackerIndex',1);
addTracker(ta,tracker1,'SensorIndices',[1,2]);
```

Create a `trackerPHD` object. The tracker takes detection inputs from sensors 3 and 4. Add the tracker to the tracking architecture and disable its direct output.

```
tracker2 = trackerPHD('TrackerIndex',2,'SensorConfigurations',...
    {trackingSensorConfiguration(3),trackingSensorConfiguration(4)});
addTracker(ta,tracker2,'ToOutput',false); % Disable output
```

Create a `trackFuser` object. The track fuser takes track inputs from the two trackers.

```
fuser = trackFuser('FuserIndex',3,'SourceConfigurations',...
    {fuserSourceConfiguration(1),fuserSourceConfiguration(2)});
addTrackFuser(ta,fuser);
```

Display the summary of the tracking architecture.

```
sum = summary(ta)
```

```
sum=3x4 table
      System      ArchitectureInputs      FuserInputs      ArchitectureOutput
      _____      _____      _____      _____
      {'T1:trackerGNN'}      {'1 2' }      {'Not applicable'}      {[      1]}
      {'T2:trackerPHD'}      {'3 4' }      {'Not applicable'}      {0x0 double}
      {'F3:trackFuser'}      {0x0 char}      {'1 2'      }      {[      2]}
```

Show the tracking architecture.

```
show(ta)
```

Tracking Architecture: ta

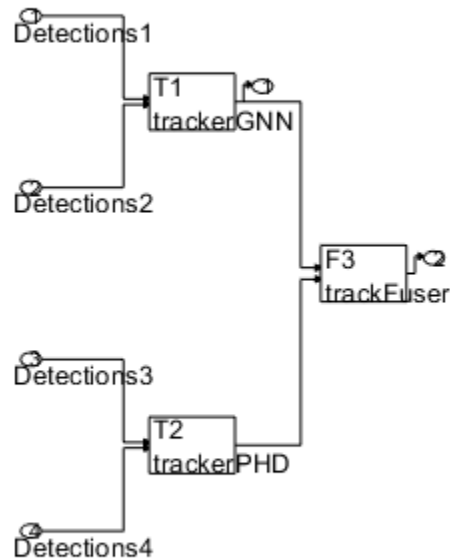

Create and Run trackingArchitecture

This architecture has two trackers:

- Tracker 1: a trackerGNN that receives detections from sensors 1 and 2.
- Tracker 2: a trackerJPDA that receives detections from sensor 3.

Both trackers pass tracks to a trackFuser that also receives tracks directly from a tracking sensor 4.

Create a trackingArchitecture object. Add two trackers with the specified sensor indices.

```
ta = trackingArchitecture;
addTracker(ta,trackerGNN('TrackerIndex',1),'SensorIndices',[1 2]);
addTracker(ta,trackerJPDA('TrackerIndex',2),'SensorIndices',3);
```

Create a trackFuser. Specify its sources using the SourceConfigurations property. Add the fuser to the tracking architecture.

```
fuser = trackFuser('FuserIndex',3,'MaxNumSources',3, ...
    'SourceConfigurations',{fuserSourceConfiguration(1); ...
    fuserSourceConfiguration(2); fuserSourceConfiguration(4)});
addTrackFuser(ta,fuser);
```

Review the architecture summary.

```
disp(summary(ta))
```

System	ArchitectureInputs	FuserInputs	ArchitectureOutput
{'T1:trackerGNN' }	{'1 2'}	{'Not applicable'}	1
{'T2:trackerJPDA' }	{'3' }	{'Not applicable'}	2
{'F3:trackFuser' }	{'4' }	{'1 2' }	3

Show the architecture in a figure.

```
figure
show(ta)
```

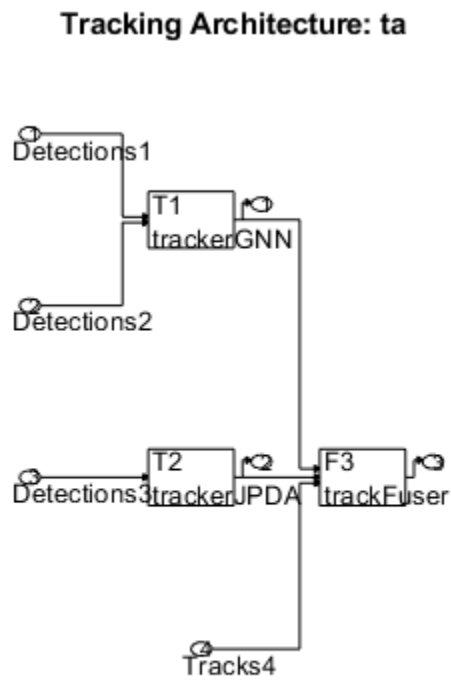

Create a display using theaterPlot to visualize the tracks generated by the trackingArchitecture later.

```
figure
ax1 = subplot(3,1,1);
p1 = theaterPlot('Parent',ax1,'XLimits',[-100 150],'YLimits',[-5 15]);
view(2)
title('GNN tracks')
t1 = trackPlotter(p1,'ConnectHistory','on','ColorizeHistory','on','DisplayName','Tracks');

ax2 =subplot(3,1,2);
p2 = theaterPlot('Parent',ax2,'XLimits',[-100 150],'YLimits',[-5 15]);
t2 = trackPlotter(p2,'ConnectHistory','on','ColorizeHistory','on','DisplayName','Tracks');
view(2)
```

```

title('JPDA tracks')

ax3 =subplot(3,1,3);
p3 = theaterPlot('Parent',ax3,'XLimits',[-100 150],'YLimits',[-5 15]);
t3 = trackPlotter(p3,'ConnectHistory','on','ColorizeHistory','on','DisplayName','Tracks');
view(2)
title('Fused tracks')

```

Load sample data into the workspace, then running it through the tracking architecture.

```

load('archInputs','detections','tracks');
positionSelector = [1 0 0 0 0 0; 0 0 1 0 0 0; 0 0 0 0 1 0];
for i = 1:numel(detections)
    [gnnTrks,jpdaTrks,fusedTrks] = ta(detections{i},tracks{i},i);
    plotTrack(t1, getTrackPositions(gnnTrks,positionSelector),string([gnnTrks.TrackID]));
    plotTrack(t2, getTrackPositions(jpdaTrks,positionSelector),string([jpdaTrks.TrackID]));
    plotTrack(t3, getTrackPositions(fusedTrks,positionSelector),string([fusedTrks.TrackID]));
end

```

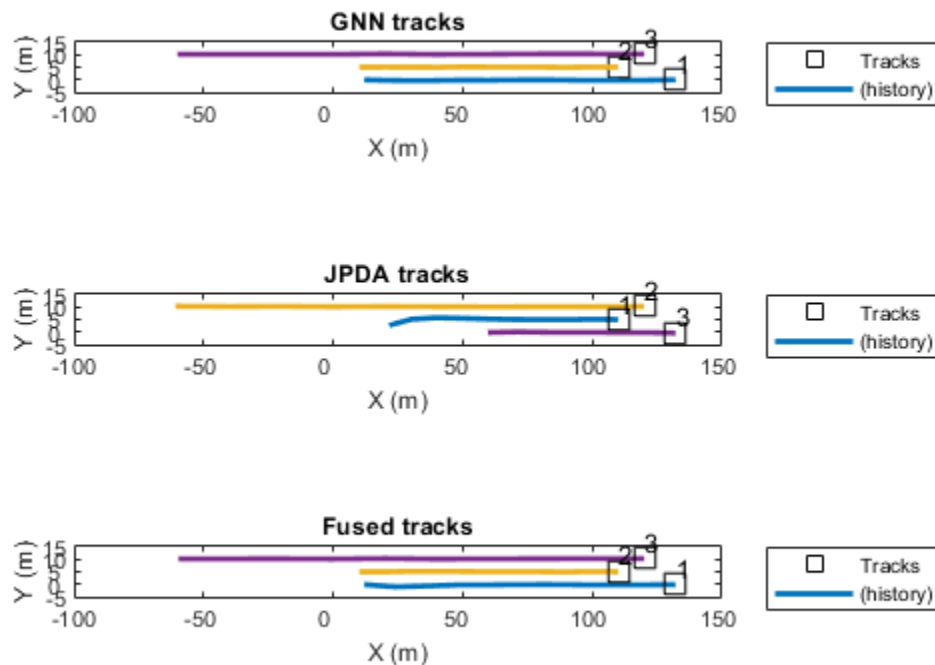

See Also

[fusion.trackingArchitecture.TrackFuser](#) | [fusion.trackingArchitecture.Tracker](#) | [objectDetection](#) | [objectTrack](#) | [trackerGNN](#) | [trackerJPDA](#) | [trackerPHD](#) | [trackerTOMHT](#)

Introduced in R2021a

addTracker

Add tracker to tracking architecture

Syntax

```
addTracker(ta,tracker)
addTracker(ta,tracker,'SensorIndices',indices)
addTracker( ____, 'ToOutput',tf)
addTracker( ____, 'Name',name)
s = addTracker( ____ )
```

Description

`addTracker(ta,tracker)` adds a tracker object `tracker` to the `trackingArchitecture` object `ta`. Use this syntax if the tracker object implements the `sensorIndices` object function. For example, `trackerPHD` implements the `sensorIndices` object function.

`addTracker(ta,tracker,'SensorIndices',indices)` specifies the indices of sensors that report detections to the `tracker`. Use this syntax if the tracker object does not implement the `sensorIndices` object function. For example, `trackerGNN`, `trackerJPDA`, and `trackerTOMHT` do not implement this object function.

`addTracker(____, 'ToOutput',tf)` specifies if the output of the added `tracker` appears in the output of tracking architecture. Specify `tf` as `true` or `false`. The default value is `true`.

`addTracker(____, 'Name',name)` enables you to specify the name of the added tracker. The specified name is shown in the outputs of the `summary` and `show` object functions.

`s = addTracker(____)` returns the summary of the tracking architecture after adding the `tracker`.

Examples

Create and Show trackingArchitecture

Create a tracking architecture.

```
ta = trackingArchitecture;
```

Create a `trackerGNN` object. The tracker takes detection inputs from sensors 1 and 2. Add the tracker to the tracking architecture.

```
tracker1 = trackerGNN('TrackerIndex',1);
addTracker(ta,tracker1,'SensorIndices',[1,2]);
```

Create a `trackerPHD` object. The tracker takes detection inputs from sensors 3 and 4. Add the tracker to the tracking architecture and disable its direct output.

```

tracker2 = trackerPHD('TrackerIndex',2,'SensorConfigurations',...
    {trackingSensorConfiguration(3),trackingSensorConfiguration(4)});
addTracker(ta,tracker2,'ToOutput',false); % Disable output

```

Create a trackFuser object. The track fuser takes track inputs from the two trackers.

```

fuser = trackFuser('FuserIndex',3,'SourceConfigurations',...
    {fuserSourceConfiguration(1),fuserSourceConfiguration(2)});
addTrackFuser(ta,fuser);

```

Display the summary of the tracking architecture.

```
sum = summary(ta)
```

```

sum=3x4 table
      System      ArchitectureInputs      FuserInputs      ArchitectureOutput
      _____      _____      _____      _____
{'T1:trackerGNN'}      {'1 2' }      {'Not applicable'}      {[      1]}
{'T2:trackerPHD'}      {'3 4' }      {'Not applicable'}      {0x0 double}
{'F3:trackFuser'}      {0x0 char}      {'1 2' }      {[      2]}

```

Show the tracking architecture.

```
show(ta)
```

Tracking Architecture: ta

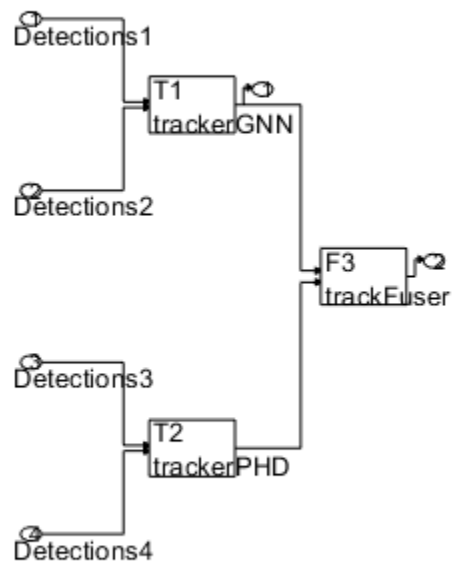

Input Arguments

ta — Tracking architecture

trackingArchitecture object

Tracking architecture, specified as a trackingArchitecture object.

tracker — Multi-object tracker

tracker object

Multi-object tracker, specified as one of these tracker objects:

- trackerGNN
- trackerJPDA
- trackerTOMHT
- trackerPHD

You can also use a customized tracker inheriting from the fusion.trackingArchitecture.Tracker class.

indices — Sensor indices

vector of positive integers

Sensor indices, specified as a vector of positive integers. The integer values must be valid sensor index values.

Example: [1 3]

tf — Enable tracker output

true (default) | false

Enable tracker output in the tracking architecture, specified as true or false.

name — Name of added tracker

string scalar | character vector

Name of the added tracker, specified as a string scalar or a character vector.

Example: 'Tracker 1'

Output Arguments

s — Tracking architecture summary

table

Tracking architecture summary, returned as a table. The number of rows of the table is equal to the total number of trackers and track fusers in the tracking architecture. The table contain these columns:

- System — A description of the system organized as 'T' or 'F' for tracker or fuser, respectively, followed by the tracker or fuser index and the class of the system. For example, 'T1: trackerJPDA' is a tracker with index 1 and class of trackerJPDA.

- **ArchitectureInputs** — The indices of inputs of the tracking architectures that report detections to the specific tracker or track fuser, shown as a cell containing a character vector. Each integer is an index of the architecture input.
- **FuserInputs** — The indices of track inputs to the specific fuser in the tracking architecture, shown as a cell containing a character vector. Each integer is the index of a tracker or track fuser in the architecture.
- **ArchitectureOutput** — The output index of the specific tracker or track fuser, shown as an integer. Each integer is the index of an output in the architecture.

See Also

[addTrackFuser](#) | [show](#) | [summary](#)

Introduced in R2021a

addTrackFuser

Add track fuser to tracking architecture

Syntax

```
addTrackFuser(ta,fuser)
addTrackFuser( ____, 'ToOutput', tf)
addTrackFuser( ____, 'Name', name)
s = addTrackFuser( ____ )
```

Description

`addTrackFuser(ta, fuser)` adds a track fuser object to the `trackingArchitecture` object `ta`.

`addTrackFuser(____, 'ToOutput', tf)` specifies if the output of the added track fuser appears in the output of the tracking architecture. Specify `tf` as `true` or `false`. The default value is `true`.

`addTrackFuser(____, 'Name', name)` enables you to specify the name of the added track fuser. The specified name is shown in the outputs of the `summary` and `show` object functions.

`s = addTrackFuser(____)` returns the summary of the tracking architecture after adding the fuser.

Examples

Create and Show trackingArchitecture

Create a tracking architecture.

```
ta = trackingArchitecture;
```

Create a `trackerGNN` object. The tracker takes detection inputs from sensors 1 and 2. Add the tracker to the tracking architecture.

```
tracker1 = trackerGNN('TrackerIndex',1);
addTracker(ta,tracker1,'SensorIndices',[1,2]);
```

Create a `trackerPHD` object. The tracker takes detection inputs from sensors 3 and 4. Add the tracker to the tracking architecture and disable its direct output.

```
tracker2 = trackerPHD('TrackerIndex',2,'SensorConfigurations',...
    {trackingSensorConfiguration(3),trackingSensorConfiguration(4)});
addTracker(ta,tracker2,'ToOutput',false); % Disable output
```

Create a `trackFuser` object. The track fuser takes track inputs from the two trackers.

```
fuser = trackFuser('FuserIndex',3,'SourceConfigurations',...
    {fuserSourceConfiguration(1),fuserSourceConfiguration(2)});
addTrackFuser(ta,fuser);
```

Display the summary of the tracking architecture.

```
sum = summary(ta)
```

```
sum=3x4 table
```

System	ArchitectureInputs	FuserInputs	ArchitectureOutput
{'T1:trackerGNN'}	{'1 2' }	{'Not applicable'}	{[1]}
{'T2:trackerPHD'}	{'3 4' }	{'Not applicable'}	{0x0 double}
{'F3:trackFuser'}	{0x0 char}	{'1 2' }	{[2]}

Show the tracking architecture.

```
show(ta)
```

Tracking Architecture: ta

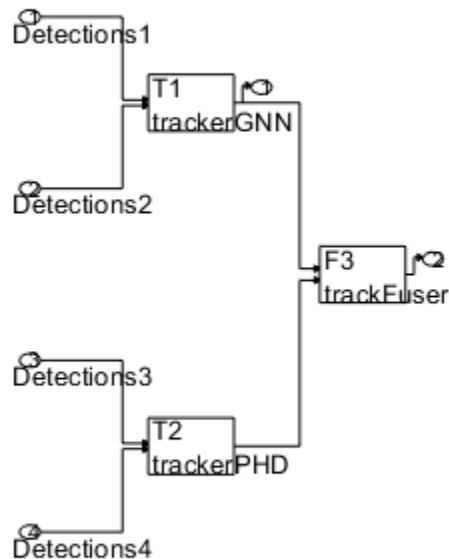

Input Arguments

ta — Tracking architecture

trackingArchitecture object

Tracking architecture, specified as a trackingArchitecture object.

fuser — Track fuser

trackFuser object

Track fuser, specified as a trackFuser object.

You can also use a customized track fuser inheriting from the `fusion.trackingArchitecture.TrackFuser` class.

tf — Enable fuser output

`true` (default) | `false`

Enable fuser output in the tracking architecture, specified as `true` or `false`.

name — Name of added track fuser

string scalar | character vector

Name of the added track fuser, specified as a string scalar or a character vector.

Example: 'Tracker 1'

Output Arguments

s — Tracking architecture summary

table

Tracking architecture summary, returned as a table. The number of rows of the table is equal to the total number of trackers and track fusers in the tracking architecture. The table contain these columns:

- **System** — A description of the system organized as 'T' or 'F' for tracker or fuser, respectively, followed by the tracker or fuser index and the class of the system. For example, 'T1: trackerJPDA' is a tracker with index 1 and class of `trackerJPDA`.
- **ArchitectureInputs** — The indices of inputs of the tracking architectures that report detections to the specific tracker or track fuser, shown as a cell containing a character vector. Each integer is an index of the architecture input.
- **FuserInputs** — The indices of track inputs to the specific fuser in the tracking architecture, shown as a cell containing a character vector. Each integer is the index of a tracker or track fuser in the architecture.
- **ArchitectureOutput** — The output index of the specific tracker or track fuser, shown as an integer. Each integer is the index of an output in the architecture.

See Also

`addTracker` | `show` | `summary`

Introduced in R2021a

summary

Display tabular summary of tracking architecture

Syntax

```
s = summary(ta)
```

Description

`s = summary(ta)` returns a summary of the `trackingArchitecture` object `ta` in a tabular form.

Examples

Create and Show trackingArchitecture

Create a tracking architecture.

```
ta = trackingArchitecture;
```

Create a `trackerGNN` object. The tracker takes detection inputs from sensors 1 and 2. Add the tracker to the tracking architecture.

```
tracker1 = trackerGNN('TrackerIndex',1);
addTracker(ta,tracker1,'SensorIndices',[1,2]);
```

Create a `trackerPHD` object. The tracker takes detection inputs from sensors 3 and 4. Add the tracker to the tracking architecture and disable its direct output.

```
tracker2 = trackerPHD('TrackerIndex',2,'SensorConfigurations',...
    {trackingSensorConfiguration(3),trackingSensorConfiguration(4)});
addTracker(ta,tracker2,'ToOutput',false); % Disable output
```

Create a `trackFuser` object. The track fuser takes track inputs from the two trackers.

```
fuser = trackFuser('FuserIndex',3,'SourceConfigurations',...
    {fuserSourceConfiguration(1),fuserSourceConfiguration(2)});
addTrackFuser(ta,fuser);
```

Display the summary of the tracking architecture.

```
sum = summary(ta)
```

```
sum=3x4 table
      System      ArchitectureInputs      FuserInputs      ArchitectureOutput
    _____  _____  _____  _____
    {'T1:trackerGNN'}      {'1 2' }      {'Not applicable'}      {[      1]}
    {'T2:trackerPHD'}      {'3 4' }      {'Not applicable'}      {0x0 double}
    {'F3:trackFuser'}      {0x0 char}      {'1 2' }      {[      2]}
```

Show the tracking architecture.

show(ta)

Tracking Architecture: ta

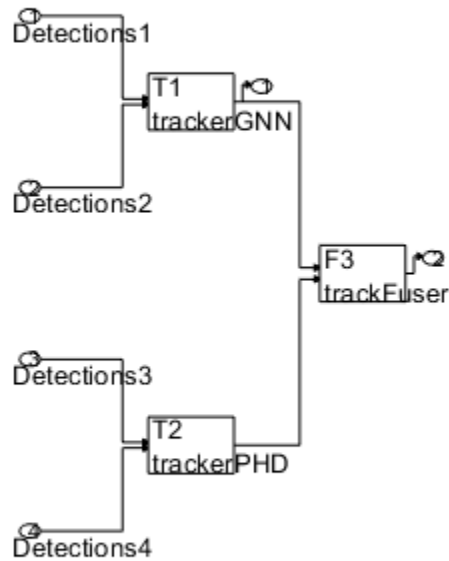

Input Arguments

ta — Tracking architecture

trackingArchitecture object

Tracking architecture, specified as a trackingArchitecture object.

Output Arguments

s — Tracking architecture summary

table

Tracking architecture summary, returned as a table. The number of rows of the table is equal to the total number of trackers and track fusers in the tracking architecture. The table contain these columns:

- System — A description of the system organized as 'T' or 'F' for tracker or fuser, respectively, followed by the tracker or fuser index and the class of the system. For example, 'T1: trackerJPDA' is a tracker with index 1 and class of trackerJPDA.
- ArchitectureInputs — The indices of inputs of the tracking architectures that report detections to the specific tracker or track fuser, shown as a cell containing a character vector. Each integer is an index of the architecture input.

- **FuserInputs** — The indices of track inputs to the specific fuser in the tracking architecture, shown as a cell containing a character vector. Each integer is the index of a tracker or track fuser in the architecture.
- **ArchitectureOutput** — The output index of the specific tracker or track fuser, shown as an integer. Each integer is the index of an output in the architecture.

See Also

`addTrackFuser` | `addTracker` | `show`

Introduced in R2021a

show

Show tracking architecture in figure

Syntax

```
show(ta)
show(ta, 'Parent', ax)
ah = show( ___ )
```

Description

`show(ta)` shows the tracking architecture `ta` in a figure.

`show(ta, 'Parent', ax)` specifies the axes `ax` on which to plot the tracking architecture.

`ah = show(___)` additionally returns the handle of the axes on which the tracking architecture is plotted.

Examples

Create and Show trackingArchitecture

Create a tracking architecture.

```
ta = trackingArchitecture;
```

Create a `trackerGNN` object. The tracker takes detection inputs from sensors 1 and 2. Add the tracker to the tracking architecture.

```
tracker1 = trackerGNN('TrackerIndex',1);
addTracker(ta,tracker1,'SensorIndices',[1,2]);
```

Create a `trackerPHD` object. The tracker takes detection inputs from sensors 3 and 4. Add the tracker to the tracking architecture and disable its direct output.

```
tracker2 = trackerPHD('TrackerIndex',2,'SensorConfigurations',...
    {trackingSensorConfiguration(3),trackingSensorConfiguration(4)});
addTracker(ta,tracker2,'ToOutput',false); % Disable output
```

Create a `trackFuser` object. The track fuser takes track inputs from the two trackers.

```
fuser = trackFuser('FuserIndex',3,'SourceConfigurations',...
    {fuserSourceConfiguration(1),fuserSourceConfiguration(2)});
addTrackFuser(ta,fuser);
```

Display the summary of the tracking architecture.

```
sum = summary(ta)
```

```
sum=3x4 table
      System      ArchitectureInputs      FuserInputs      ArchitectureOutput
```

```

{'T1:trackerGNN'}      {'1 2' }      {'Not applicable'}      {[      1]}
{'T2:trackerPHD'}     {'3 4' }      {'Not applicable'}     {0x0 double}
{'F3:trackFuser'}     {0x0 char}   {'1 2' }               {[      2]}

```

Show the tracking architecture.

```
show(ta)
```

Tracking Architecture: ta

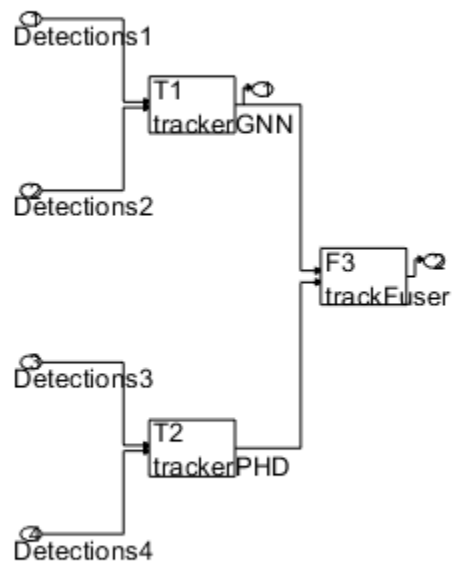

Input Arguments

ta – Tracking architecture

trackingArchitecture object

Tracking architecture, specified as a trackingArchitecture object.

ax – Axes on which to plot tracking architecture

axes handle

Axes on which to plot the tracking architecture, specified as an axes handle.

Output Arguments

ah — Axes on which tracking architecture is plotted

axes handle

Axes on which the tracking architecture is plotted, returned as an axes handle.

See Also

[addTrackFuser](#) | [addTracker](#) | [summary](#)

Introduced in R2021a

fusion.trackingArchitecture.Tracker class

Interface definition for trackingArchitecture tracker

Description

The `fusion.trackingArchitecture.Tracker` abstract class defines the interface for a tracker used in the `trackingArchitecture` System object. To custom a tracker class used in the `trackingArchitecture` System object, create a class that inherits from the `fusion.trackingArchitecture.Tracker` class. The class definition must have this format,

```
classdef customTrackerClass < fusion.trackingArchitecture.Tracker
```

where `customTrackerClass` is the name of your custom tracker class.

The custom class must implement these “Properties” on page 3-575 and “Methods” on page 3-576. To add the customized tracker to a tracking architecture, use the `addTracker` function.

The `fusion.trackingArchitecture.Tracker` class is a `handle` class.

Class Attributes

Abstract	true
----------	------

For information on class attributes, see “Class Attributes”.

Properties

TrackerIndex — Unique index of the tracker

positive integer

Unique index of the tracker in the tracking architecture, specified as positive integer.

Example: 2

Attributes:

Abstract	true
----------	------

Methods

Public Methods

step	<p><code>confirmedTracks = step(trackerObj,detections,time)</code></p> <p>runs the tracker based on the <code>detections</code> input and the simulation <code>time</code> input. It also returns the confirmed tracks.</p> <ul style="list-style-type: none"> • <code>trackerObj</code> — The tracker object. • <code>detections</code> — Object detections, specified as an array of <code>objectDetection</code> objects, a cell array of <code>objectDetection</code> objects, or an array of structures. If specified as structures, the field names of each structure must be the same as the property names of the <code>objectDetection</code> object. • <code>time</code> — Simulation time, specified as a nonnegative scalar. The tracker predicts all tracks to the specified <code>time</code>. <table border="1" data-bbox="865 934 1474 976"> <tr> <td>Abstract</td> <td>true</td> </tr> </table>	Abstract	true
Abstract	true		
isLocked	<p><code>tf = isLocked(trackerObj)</code></p> <p>determines if the tracker is in use.</p> <ul style="list-style-type: none"> • <code>trackerObj</code> — The tracker object. • <code>tf</code> — Indicate if the tracker is stepped, returned as <code>true</code> or <code>false</code>. <table border="1" data-bbox="865 1218 1474 1260"> <tr> <td>Abstract</td> <td>true</td> </tr> </table>	Abstract	true
Abstract	true		
reset	<p><code>reset(trackerObj)</code></p> <p>resets the internal states of the tracker object <code>trackerObj</code>.</p> <table border="1" data-bbox="865 1402 1474 1444"> <tr> <td>Abstract</td> <td>true</td> </tr> </table>	Abstract	true
Abstract	true		
release	<p><code>release(trackerObj)</code></p> <p>releases system resources such as memory, file handles, or hardware connections, and allows you to change properties and input characteristics of the tracker object <code>trackerObj</code>.</p> <table border="1" data-bbox="865 1648 1474 1690"> <tr> <td>Abstract</td> <td>true</td> </tr> </table>	Abstract	true
Abstract	true		

clone	clonedTracker = clone(trackerObj) creates a copy clonedTracker that has the same property values and states as the tracker object trackerObj.	
	Abstract	true

See Also

[addTracker](#) | [fusion.trackingArchitecture.TrackFuser](#) | [trackingArchitecture](#)

Introduced in R2021a

fusion.trackingArchitecture.TrackFuser class

Interface definition for trackingArchitecture track fuser

Description

The `fusion.trackingArchitecture.TrackFuser` abstract class defines the interface for a track fuser used in the `trackingArchitecture` System object. To custom a track fuser class used in the `trackingArchitecture` System object, create a class that inherits from the `fusion.trackingArchitecture.TrackFuser` class. The class definition must have this format,

```
classdef customTrackFuserClass < fusion.trackingArchitecture.TrackFuser
```

where `customTrackFuserClass` is the name of your custom track fuser class.

The custom class must implement these “Properties” on page 3-578 and “Methods” on page 3-579. To add the customized track fuser to a tracking architecture, use the `addTrackFuser` function.

The `fusion.trackingArchitecture.TrackFuser` class is a `handle` class.

Class Attributes

Abstract	true
----------	------

For information on class attributes, see “Class Attributes”.

Properties

FuserIndex — Unique index of the track fuser

positive integer

Unique index of the track fuser in the tracking architecture, specified as positive integer.

Example: 2

Attributes:

Abstract	true
----------	------

Methods

Public Methods

step	<p><code>confirmedTracks = step(fuserObj, localTracks, time)</code></p> <p>runs the fuser based on the <code>localTracks</code> input and the simulation <code>time</code> input. It also returns the confirmed tracks.</p> <ul style="list-style-type: none"> • <code>fuserObj</code> — The track fuser object. • <code>localTracks</code> — Local or source tracks, specified as an array of <code>objectTrack</code> objects or an array of structures. If specified as structures, the field names of each structure must be the same as the property names of the <code>objectTrack</code> object. • <code>time</code> — Simulation time, specified as a nonnegative scalar. The tracker predicts all tracks to the specified <code>time</code>. <table border="1" data-bbox="865 905 1472 951"> <tr> <td>Abstract</td> <td>true</td> </tr> </table>	Abstract	true
Abstract	true		
isLocked	<p><code>tf = isLocked(fuserObj)</code></p> <p>determines if the track fuser is in use.</p> <ul style="list-style-type: none"> • <code>fuserObj</code> — The fuser object. • <code>tf</code> — Indicate if the fuser is in use, returned as <code>true</code> or <code>false</code>. <table border="1" data-bbox="865 1188 1472 1234"> <tr> <td>Abstract</td> <td>true</td> </tr> </table>	Abstract	true
Abstract	true		
reset	<p><code>reset(fuserObj)</code></p> <p>resets the internal states of the track fuser object <code>fuserObj</code>.</p> <table border="1" data-bbox="865 1373 1472 1419"> <tr> <td>Abstract</td> <td>true</td> </tr> </table>	Abstract	true
Abstract	true		
release	<p><code>release(fuserObj)</code></p> <p>releases system resources such as memory, file handles, or hardware connections, and allows you to change properties and input characteristics of the track fuser object <code>fuserObj</code>.</p> <table border="1" data-bbox="865 1621 1472 1667"> <tr> <td>Abstract</td> <td>true</td> </tr> </table>	Abstract	true
Abstract	true		
clone	<p><code>clonedFuser = clone(fuserObj)</code></p> <p>creates a copy <code>clonedFuser</code> that has the same property values and states as the track fuser object <code>fuserObj</code>.</p> <table border="1" data-bbox="865 1831 1472 1877"> <tr> <td>Abstract</td> <td>true</td> </tr> </table>	Abstract	true
Abstract	true		

sourceIndices	indices = sourceIndices(fuserObj)	
	returns the indices of sources to the track fuser object fuserObj. indices lists the indices of sources to the fuser, returned as a vector of nonnegative integers.	
	Abstract	true

See Also

addTrackFuser | fusion.trackingArchitecture.Tracker | trackingArchitecture

Introduced in R2021a

imuSensor

IMU simulation model

Description

The `imuSensor` System object models receiving data from an inertial measurement unit (IMU).

To model an IMU:

- 1 Create the `imuSensor` object and set its properties.
- 2 Call the object with arguments, as if it were a function.

To learn more about how System objects work, see [What Are System Objects?](#).

Creation

Syntax

```
IMU = imuSensor
IMU = imuSensor('accel-gyro')
IMU = imuSensor('accel-mag')
IMU = imuSensor('accel-gyro-mag')
IMU = imuSensor( ___, 'ReferenceFrame', RF)
IMU = imuSensor( ___, Name, Value)
```

Description

`IMU = imuSensor` returns a System object, `IMU`, that computes an inertial measurement unit reading based on an inertial input signal. `IMU` has an ideal accelerometer and gyroscope.

`IMU = imuSensor('accel-gyro')` returns an `imuSensor` System object with an ideal accelerometer and gyroscope. `imuSensor` and `imuSensor('accel-gyro')` are equivalent creation syntaxes.

`IMU = imuSensor('accel-mag')` returns an `imuSensor` System object with an ideal accelerometer and magnetometer.

`IMU = imuSensor('accel-gyro-mag')` returns an `imuSensor` System object with an ideal accelerometer, gyroscope, and magnetometer.

`IMU = imuSensor(___, 'ReferenceFrame', RF)` returns an `imuSensor` System object that computes an inertial measurement unit reading relative to the reference frame `RF`. Specify `RF` as `'NED'` (North-East-Down) or `'ENU'` (East-North-Up). The default value is `'NED'`.

`IMU = imuSensor(___, Name, Value)` sets each property `Name` to the specified `Value`. Unspecified properties have default values. This syntax can be used in combination with any of the previous input arguments.

Properties

Unless otherwise indicated, properties are *nontunable*, which means you cannot change their values after calling the object. Objects lock when you call them, and the `release` function unlocks them.

If a property is *tunable*, you can change its value at any time.

For more information on changing property values, see System Design in MATLAB Using System Objects.

IMUType — Type of inertial measurement unit

'accel-gyro' (default) | 'accel-mag' | 'accel-gyro-mag'

Type of inertial measurement unit, specified as a 'accel-gyro', 'accel-mag', or 'accel-gyro-mag'.

The type of inertial measurement unit specifies which sensor readings to model:

- 'accel-gyro' -- Accelerometer and gyroscope
- 'accel-mag' -- Accelerometer and magnetometer
- 'accel-gyro-mag' -- Accelerometer, gyroscope, and magnetometer

You can specify `IMUType` as a value-only argument during creation or as a Name, Value pair.

Data Types: char | string

SampleRate — Sample rate of sensor (Hz)

100 (default) | positive scalar

Sample rate of the sensor model in Hz, specified as a positive scalar.

Data Types: single | double

Temperature — Temperature of IMU (°C)

25 (default) | real scalar

Operating temperature of the IMU in degrees Celsius, specified as a real scalar.

When the object calculates temperature scale factors and environmental drift noises, 25 °C is used as the nominal temperature.

Tunable: Yes

Data Types: single | double

MagneticField — Magnetic field vector in local navigation coordinate system (μT)

[27.5550 -2.4169 -16.0849] (default) | real scalar

Magnetic field vector in microtesla, specified as a three-element row vector in the local navigation coordinate system.

The default magnetic field corresponds to the magnetic field at latitude zero, longitude zero, and altitude zero.

Tunable: Yes

Data Types: single | double

Accelerometer — Accelerometer sensor parameters

accelparams object (default)

Accelerometer sensor parameters, specified by an accelparams object.

Tunable: Yes**Gyroscope — Gyroscope sensor parameters**

gyroparams object (default)

Gyroscope sensor parameters, specified by a gyroparams object.

Tunable: Yes**Magnetometer — Magnetometer sensor parameters**

magparams object (default)

Magnetometer sensor parameters, specified by a magparams object.

Tunable: Yes**RandomStream — Random number source**

'Global stream' (default) | 'mt19937ar with seed'

Random number source, specified as a character vector or string:

- 'Global stream' -- Random numbers are generated using the current global random number stream.
- 'mt19937ar with seed' -- Random numbers are generated using the mt19937ar algorithm with the seed specified by the Seed property.

Data Types: char | string

Seed — Initial seed

67 (default) | nonnegative integer scalar

Initial seed of an mt19937ar random number generator algorithm, specified as a real, nonnegative integer scalar.

Dependencies

To enable this property, set RandomStream to 'mt19937ar with seed'.

Data Types: single | double | int8 | int16 | int32 | int64 | uint8 | uint16 | uint32 | uint64

Usage**Syntax**

```
[accelReadings,gyroReadings] = IMU(acc,angVel)
[accelReadings,gyroReadings] = IMU(acc,angVel,orientation)
```

```
[accelReadings,magReadings] = IMU(acc,angVel)
[accelReadings,magReadings] = IMU(acc,angVel,orientation)
```

```
[accelReadings,gyroReadings,magReadings] = IMU(acc,angVel)
[accelReadings,gyroReadings,magReadings] = IMU(acc,angVel,orientation)
```

Description

[accelReadings,gyroReadings] = IMU(acc,angVel) generates accelerometer and gyroscope readings from the acceleration and angular velocity inputs.

This syntax is only valid if IMUType is set to 'accel-gyro' or 'accel-gyro-mag'.

[accelReadings,gyroReadings] = IMU(acc,angVel,orientation) generates accelerometer and gyroscope readings from the acceleration, angular velocity, and orientation inputs.

This syntax is only valid if IMUType is set to 'accel-gyro' or 'accel-gyro-mag'.

[accelReadings,magReadings] = IMU(acc,angVel) generates accelerometer and magnetometer readings from the acceleration and angular velocity inputs.

This syntax is only valid if IMUType is set to 'accel-mag'.

[accelReadings,magReadings] = IMU(acc,angVel,orientation) generates accelerometer and magnetometer readings from the acceleration, angular velocity, and orientation inputs.

This syntax is only valid if IMUType is set to 'accel-mag'.

[accelReadings,gyroReadings,magReadings] = IMU(acc,angVel) generates accelerometer, gyroscope, and magnetometer readings from the acceleration and angular velocity inputs.

This syntax is only valid if IMUType is set to 'accel-gyro-mag'.

[accelReadings,gyroReadings,magReadings] = IMU(acc,angVel,orientation) generates accelerometer, gyroscope, and magnetometer readings from the acceleration, angular velocity, and orientation inputs.

This syntax is only valid if IMUType is set to 'accel-gyro-mag'.

Input Arguments

acc — Acceleration of IMU in local navigation coordinate system (m/s²)

N-by-3 matrix

Acceleration of the IMU in the local navigation coordinate system, specified as a real, finite *N*-by-3 array in meters per second squared. *N* is the number of samples in the current frame.

Data Types: single | double

angVel — Angular velocity of IMU in local navigation coordinate system (rad/s)

N-by-3 matrix

Angular velocity of the IMU in the local navigation coordinate system, specified as a real, finite *N*-by-3 array in radians per second. *N* is the number of samples in the current frame.

Data Types: single | double

orientation — Orientation of IMU in local navigation coordinate system

N-element quaternion column vector | 3-by-3-by-*N*-element rotation matrix

Orientation of the IMU with respect to the local navigation coordinate system, specified as a quaternion N -element column vector or a 3-by-3-by- N rotation matrix. Each quaternion or rotation matrix represents a frame rotation from the local navigation coordinate system to the current IMU sensor body coordinate system. N is the number of samples in the current frame.

Data Types: `single` | `double` | `quaternion`

Output Arguments

accelReadings — Accelerometer measurement of IMU in sensor body coordinate system (m/s^2)

N -by-3 matrix

Accelerometer measurement of the IMU in the sensor body coordinate system, specified as a real, finite N -by-3 array in meters per second squared. N is the number of samples in the current frame.

Data Types: `single` | `double`

gyroReadings — Gyroscope measurement of IMU in sensor body coordinate system (rad/s)

N -by-3 matrix

Gyroscope measurement of the IMU in the sensor body coordinate system, specified as a real, finite N -by-3 array in radians per second. N is the number of samples in the current frame.

Data Types: `single` | `double`

magReadings — Magnetometer measurement of IMU in sensor body coordinate system (μT)

N -by-3 matrix (default)

Magnetometer measurement of the IMU in the sensor body coordinate system, specified as a real, finite N -by-3 array in microtesla. N is the number of samples in the current frame.

Data Types: `single` | `double`

Object Functions

To use an object function, specify the System object as the first input argument. For example, to release system resources of a System object named `obj`, use this syntax:

```
release(obj)
```

Specific to `imuSensor`

`loadparams` Load sensor parameters from JSON file

Common to All System Objects

<code>step</code>	Run System object algorithm
<code>release</code>	Release resources and allow changes to System object property values and input characteristics
<code>reset</code>	Reset internal states of System object

Examples

Create Default imuSensor System object

The `imuSensor` System object™ enables you to model the data received from an inertial measurement unit consisting of a combination of gyroscope, accelerometer, and magnetometer.

Create a default `imuSensor` object.

```
IMU = imuSensor

IMU =
  imuSensor with properties:

    IMUType: 'accel-gyro'
    SampleRate: 100
    Temperature: 25
    Accelerometer: [1x1 accelparams]
    Gyroscope: [1x1 gyroparams]
    RandomStream: 'Global stream'
```

The `imuSensor` object, `IMU`, contains an idealized gyroscope and accelerometer. Use dot notation to view properties of the gyroscope.

`IMU.Gyroscope`

```
ans =
  gyroparams with properties:

    MeasurementRange: Inf          rad/s
    Resolution: 0                 (rad/s)/LSB
    ConstantBias: [0 0 0]         rad/s
    AxesMisalignment: [0 0 0]     %

    NoiseDensity: [0 0 0]        (rad/s)/√Hz
    BiasInstability: [0 0 0]     rad/s
    RandomWalk: [0 0 0]          (rad/s)*√Hz

    TemperatureBias: [0 0 0]     (rad/s)/°C
    TemperatureScaleFactor: [0 0 0] %/°C
    AccelerationBias: [0 0 0]    (rad/s)/(m/s²)
```

Sensor properties are defined by corresponding parameter objects. For example, the gyroscope model used by the `imuSensor` is defined by an instance of the `gyroparams` class. You can modify properties of the gyroscope model using dot notation. Set the gyroscope measurement range to 4.3 rad/s.

```
IMU.Gyroscope.MeasurementRange = 4.3;
```

You can also set sensor properties to preset parameter objects. Create an `accelparams` object to mimic specific hardware, and then set the `IMU Accelerometer` property to the `accelparams` object. Display the `Accelerometer` property to verify the properties are correctly set.

```
SpecSheet1 = accelparams( ...
    'MeasurementRange',19.62, ...
    'Resolution',0.00059875, ...
    'ConstantBias',0.4905, ...
    'AxesMisalignment',2, ...
```

```

    'NoiseDensity',0.003924, ...
    'BiasInstability',0, ...
    'TemperatureBias', [0.34335 0.34335 0.5886], ...
    'TemperatureScaleFactor', 0.02);

IMU.Accelerometer = SpecSheet1;

IMU.Accelerometer

ans =
  accelparams with properties:

    MeasurementRange: 19.62                m/s2
      Resolution: 0.00059875              (m/s2)/LSB
    ConstantBias: [0.4905 0.4905 0.4905]  m/s2
  AxesMisalignment: [2 2 2]              %

    NoiseDensity: [0.003924 0.003924 0.003924] (m/s2)/√Hz
  BiasInstability: [0 0 0]                m/s2
    RandomWalk: [0 0 0]                  (m/s2)*√Hz

    TemperatureBias: [0.34335 0.34335 0.5886] (m/s2)/°C
  TemperatureScaleFactor: [0.02 0.02 0.02]  %/°C

```

Generate Ideal IMU Data from Stationary Input

Use the `imuSensor` System object™ to model receiving data from a stationary ideal IMU containing an accelerometer, gyroscope, and magnetometer.

Create an ideal IMU sensor model that contains an accelerometer, gyroscope, and magnetometer.

```

IMU = imuSensor('accel-gyro-mag')

IMU =
  imuSensor with properties:

    IMUType: 'accel-gyro-mag'
    SampleRate: 100
    Temperature: 25
  MagneticField: [27.5550 -2.4169 -16.0849]
  Accelerometer: [1x1 accelparams]
    Gyroscope: [1x1 gyroparams]
  Magnetometer: [1x1 magparams]
  RandomStream: 'Global stream'

```

Define the ground-truth, underlying motion of the IMU you are modeling. The acceleration and angular velocity are defined relative to the local NED coordinate system.

```

numSamples = 1000;
acceleration = zeros(numSamples,3);
angularVelocity = zeros(numSamples,3);

```

Call `IMU` with the ground-truth acceleration and angular velocity. The object outputs accelerometer readings, gyroscope readings, and magnetometer readings, as modeled by the properties of the

imuSensor System object. The accelerometer readings, gyroscope readings, and magnetometer readings are relative to the IMU sensor body coordinate system.

```
[accelReading,gyroReading,magReading] = IMU(acceleration,angularVelocity);
```

Plot the accelerometer readings, gyroscope readings, and magnetometer readings.

```
t = (0:(numSamples-1))/IMU.SampleRate;  
subplot(3,1,1)  
plot(t,accelReading)  
legend('X-axis','Y-axis','Z-axis')  
title('Accelerometer Readings')  
ylabel('Acceleration (m/s^2)')  
  
subplot(3,1,2)  
plot(t,gyroReading)  
legend('X-axis','Y-axis','Z-axis')  
title('Gyroscope Readings')  
ylabel('Angular Velocity (rad/s)')  
  
subplot(3,1,3)  
plot(t,magReading)  
legend('X-axis','Y-axis','Z-axis')  
title('Magnetometer Readings')  
xlabel('Time (s)')  
ylabel('Magnetic Field (uT)')
```

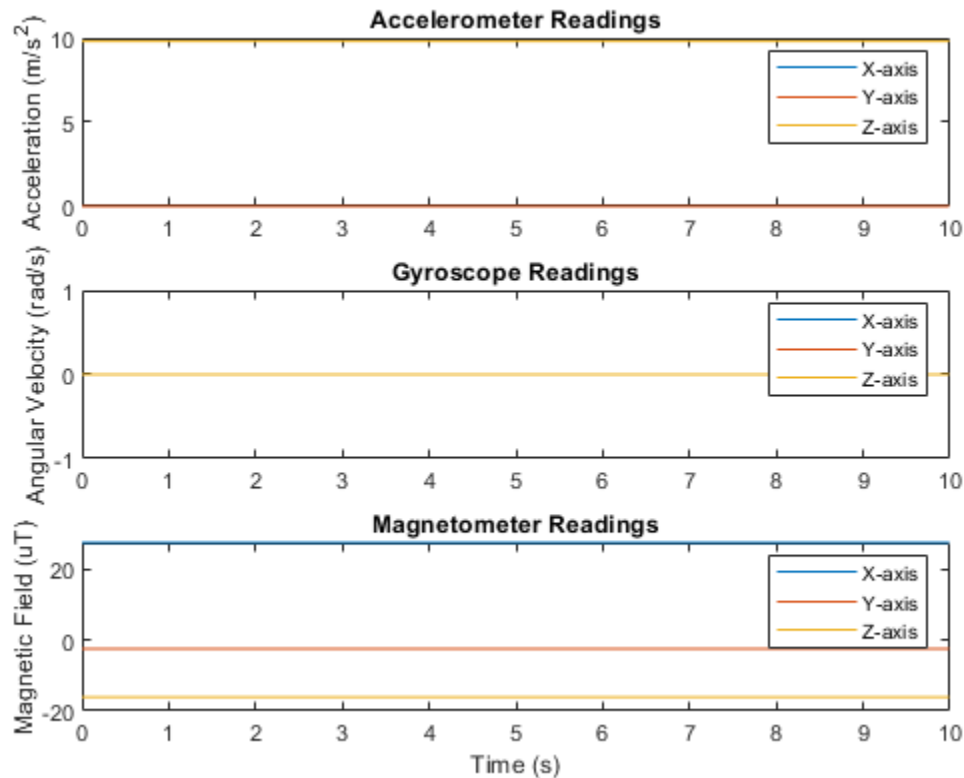

Orientation is not specified and the ground-truth motion is stationary, so the IMU sensor body coordinate system and the local NED coordinate system overlap for the entire simulation.

- Accelerometer readings: The z-axis of the sensor body corresponds to the Down-axis. The 9.8 m/s^2 acceleration along the z-axis is due to gravity.
- Gyroscope readings: The gyroscope readings are zero along each axis, as expected.
- Magnetometer readings: Because the sensor body coordinate system is aligned with the local NED coordinate system, the magnetometer readings correspond to the `MagneticField` property of `imuSensor`. The `MagneticField` property is defined in the local NED coordinate system.

Model Rotating Six-Axis IMU Data

Use `imuSensor` to model data obtained from a rotating IMU containing an ideal accelerometer and an ideal magnetometer. Use `kinematicTrajectory` to define the ground-truth motion. Fuse the `imuSensor` model output using the `ecompass` function to determine orientation over time.

Define the ground-truth motion for a platform that rotates 360 degrees in four seconds, and then another 360 degrees in two seconds. Use `kinematicTrajectory` to output the orientation, acceleration, and angular velocity in the NED coordinate system.

```
fs = 100;
firstLoopNumSamples = fs*4;
secondLoopNumSamples = fs*2;
totalNumSamples = firstLoopNumSamples + secondLoopNumSamples;

traj = kinematicTrajectory('SampleRate',fs);

accBody = zeros(totalNumSamples,3);
angVelBody = zeros(totalNumSamples,3);
angVelBody(1:firstLoopNumSamples,3) = (2*pi)/4;
angVelBody(firstLoopNumSamples+1:end,3) = (2*pi)/2;

[~,orientationNED,~,accNED,angVelNED] = traj(accBody,angVelBody);
```

Create an `imuSensor` object with an ideal accelerometer and an ideal magnetometer. Call `IMU` with the ground-truth acceleration, angular velocity, and orientation to output accelerometer readings and magnetometer readings. Plot the results.

```
IMU = imuSensor('accel-mag','SampleRate',fs);

[accelReadings,magReadings] = IMU(accNED,angVelNED,orientationNED);

figure(1)
t = (0:(totalNumSamples-1))/fs;
subplot(2,1,1)
plot(t,accelReadings)
legend('X-axis','Y-axis','Z-axis')
ylabel('Acceleration (m/s^2)')
title('Accelerometer Readings')

subplot(2,1,2)
plot(t,magReadings)
legend('X-axis','Y-axis','Z-axis')
```

```
ylabel('Magnetic Field (\u03bcT)')
xlabel('Time (s)')
title('Magnetometer Readings')
```

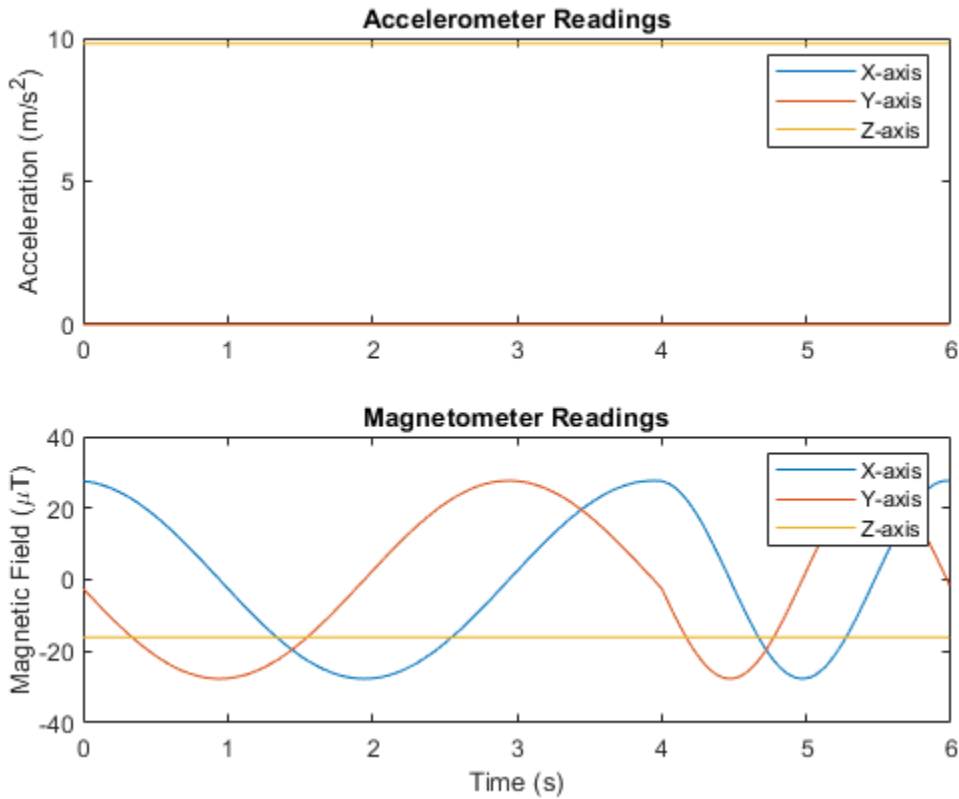

The accelerometer readings indicate that the platform has no translation. The magnetometer readings indicate that the platform is rotating around the z-axis.

Feed the accelerometer and magnetometer readings into the `ecompass` function to estimate the orientation over time. The `ecompass` function returns orientation in quaternion format. Convert orientation to Euler angles and plot the results. The orientation plot indicates that the platform rotates about the z-axis only.

```
orientation = ecompass(accelReadings,magReadings);
orientationEuler = eulerd(orientation,'ZYX','frame');

figure(2)
plot(t,orientationEuler)
legend('Z-axis','Y-axis','X-axis')
xlabel('Time (s)')
ylabel('Rotation (degrees)')
title('Orientation')
```

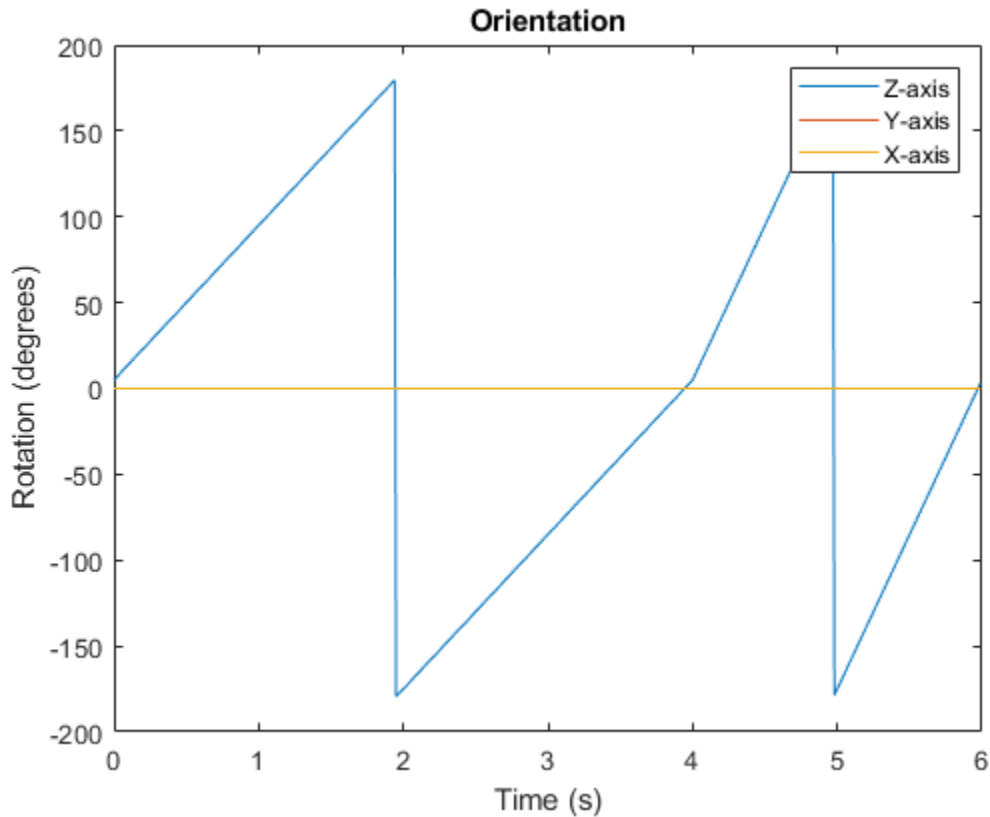
Model Rotating Six-Axis IMU Data with Noise

Use `imuSensor` to model data obtained from a rotating IMU containing a realistic accelerometer and a realistic magnetometer. Use `kinematicTrajectory` to define the ground-truth motion. Fuse the `imuSensor` model output using the `ecompass` function to determine orientation over time.

Define the ground-truth motion for a platform that rotates 360 degrees in four seconds, and then another 360 degrees in two seconds. Use `kinematicTrajectory` to output the orientation, acceleration, and angular velocity in the NED coordinate system.

```
fs = 100;
firstLoopNumSamples = fs*4;
secondLoopNumSamples = fs*2;
totalNumSamples = firstLoopNumSamples + secondLoopNumSamples;

traj = kinematicTrajectory('SampleRate',fs);

accBody = zeros(totalNumSamples,3);
angVelBody = zeros(totalNumSamples,3);
angVelBody(1:firstLoopNumSamples,3) = (2*pi)/4;
angVelBody(firstLoopNumSamples+1:end,3) = (2*pi)/2;

[~,orientationNED,~,accNED,angVelNED] = traj(accBody,angVelBody);
```

Create an `imuSensor` object with a realistic accelerometer and a realistic magnetometer. Call `IMU` with the ground-truth acceleration, angular velocity, and orientation to output accelerometer readings and magnetometer readings. Plot the results.

```
IMU = imuSensor('accel-mag','SampleRate',fs);

IMU.Accelerometer = accelparams( ...
    'MeasurementRange',19.62, ...           % m/s^2
    'Resolution',0.0023936, ...           % m/s^2 / LSB
    'TemperatureScaleFactor',0.008, ...    % % / degree C
    'ConstantBias',0.1962, ...           % m/s^2
    'TemperatureBias',0.0014715, ...      % m/s^2 / degree C
    'NoiseDensity',0.0012361);           % m/s^2 / Hz^(1/2)

IMU.Magnetometer = magparams( ...
    'MeasurementRange',1200, ...          % uT
    'Resolution',0.1, ...                 % uT / LSB
    'TemperatureScaleFactor',0.1, ...     % % / degree C
    'ConstantBias',1, ...                 % uT
    'TemperatureBias',[0.8 0.8 2.4], ... % uT / degree C
    'NoiseDensity',[0.6 0.6 0.9]/sqrt(100)); % uT / Hz^(1/2)

[accelReadings,magReadings] = IMU(accNED,angVelNED,orientationNED);

figure(1)
t = (0:(totalNumSamples-1))/fs;
subplot(2,1,1)
plot(t,accelReadings)
legend('X-axis','Y-axis','Z-axis')
ylabel('Acceleration (m/s^2)')
title('Accelerometer Readings')

subplot(2,1,2)
plot(t,magReadings)
legend('X-axis','Y-axis','Z-axis')
ylabel('Magnetic Field (\u03bcT)')
xlabel('Time (s)')
title('Magnetometer Readings')
```

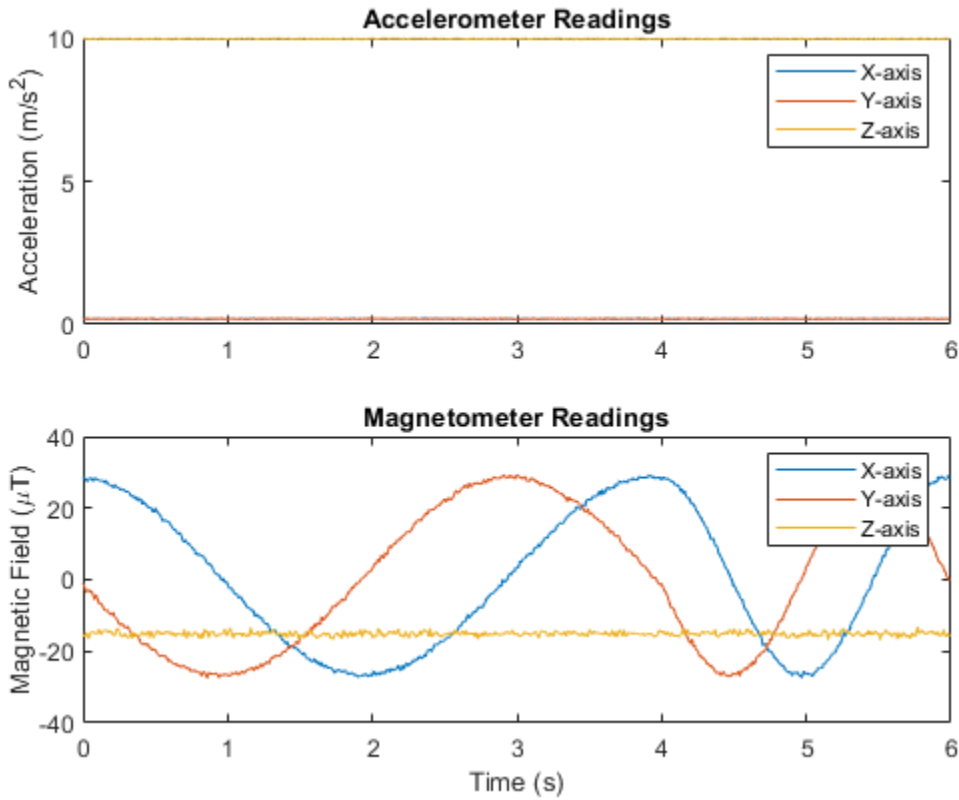

The accelerometer readings indicate that the platform has no translation. The magnetometer readings indicate that the platform is rotating around the z-axis.

Feed the accelerometer and magnetometer readings into the `ecompass` function to estimate the orientation over time. The `ecompass` function returns orientation in quaternion format. Convert orientation to Euler angles and plot the results. The orientation plot indicates that the platform rotates about the z-axis only.

```
orientation = ecompass(accelReadings,magReadings);

orientationEuler = eulerd(orientation,'ZYX','frame');

figure(2)
plot(t,orientationEuler)
legend('Z-axis','Y-axis','X-axis')
xlabel('Time (s)')
ylabel('Rotation (degrees)')
title('Orientation')
```

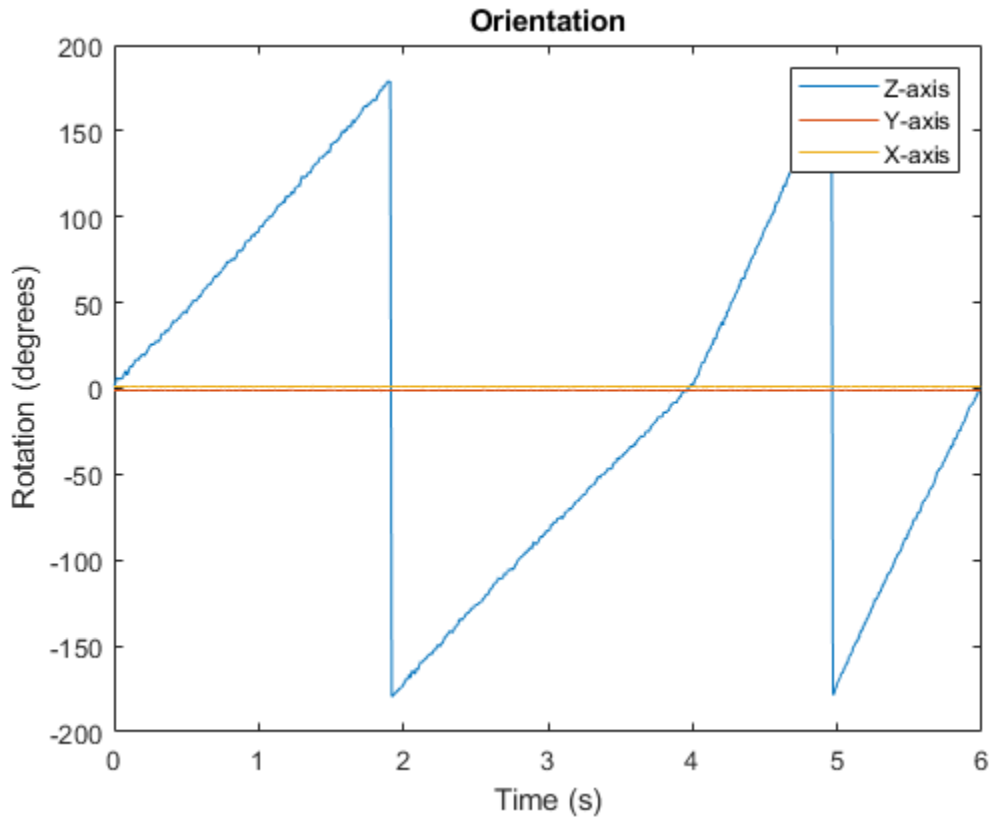

%

Model Tilt Using Gyroscope and Accelerometer Readings

Model a tilting IMU that contains an accelerometer and gyroscope using the `imuSensor` System object™. Use ideal and realistic models to compare the results of orientation tracking using the `imuFilter` System object.

Load a struct describing ground-truth motion and a sample rate. The motion struct describes sequential rotations:

- 1 yaw: 120 degrees over two seconds
- 2 pitch: 60 degrees over one second
- 3 roll: 30 degrees over one-half second
- 4 roll: -30 degrees over one-half second
- 5 pitch: -60 degrees over one second
- 6 yaw: -120 degrees over two seconds

In the last stage, the motion struct combines the 1st, 2nd, and 3rd rotations into a single-axis rotation. The acceleration, angular velocity, and orientation are defined in the local NED coordinate system.

```
load y120p60r30.mat motion fs
accNED = motion.Acceleration;
angVelNED = motion.AngularVelocity;
orientationNED = motion.Orientation;
```

```
numSamples = size(motion.Orientation,1);
t = (0:(numSamples-1)).'/fs;
```

Create an ideal IMU sensor object and a default IMU filter object.

```
IMU = imuSensor('accel-gyro', 'SampleRate', fs);
```

```
aFilter = imufilter('SampleRate', fs);
```

In a loop:

- 1 Simulate IMU output by feeding the ground-truth motion to the IMU sensor object.
- 2 Filter the IMU output using the default IMU filter object.

```
orientation = zeros(numSamples,1, 'quaternion');
for i = 1:numSamples
    [accelBody, gyroBody] = IMU(accNED(i,:), angVelNED(i,:), orientationNED(i,:));
    orientation(i) = aFilter(accelBody, gyroBody);
```

```
end
release(aFilter)
```

Plot the orientation over time.

```
figure(1)
plot(t, eulerd(orientation, 'ZYX', 'frame'))
xlabel('Time (s)')
ylabel('Rotation (degrees)')
title('Orientation Estimation -- Ideal IMU Data, Default IMU Filter')
legend('Z-axis', 'Y-axis', 'X-axis')
```

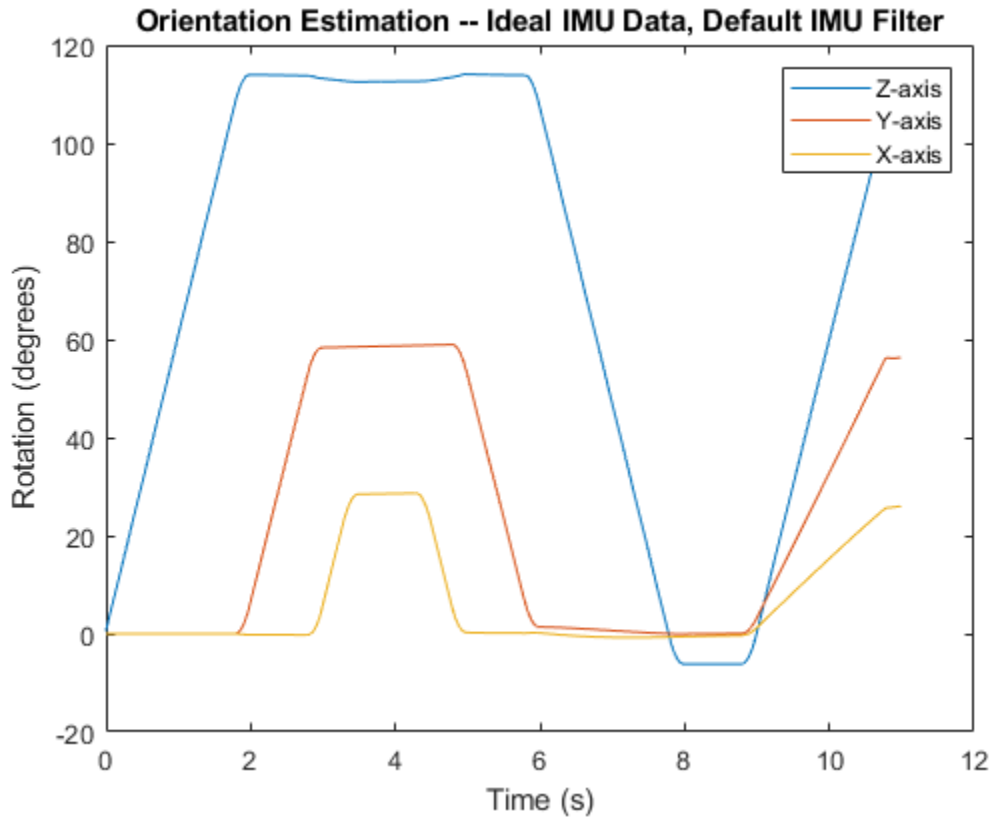

Modify properties of your `imuSensor` to model real-world sensors. Run the loop again and plot the orientation estimate over time.

```

IMU.Accelerometer = accelparams( ...
    'MeasurementRange',19.62, ...
    'Resolution',0.00059875, ...
    'ConstantBias',0.4905, ...
    'AxesMisalignment',2, ...
    'NoiseDensity',0.003924, ...
    'BiasInstability',0, ...
    'TemperatureBias', [0.34335 0.34335 0.5886], ...
    'TemperatureScaleFactor',0.02);
IMU.Gyroscope = gyroparams( ...
    'MeasurementRange',4.3633, ...
    'Resolution',0.00013323, ...
    'AxesMisalignment',2, ...
    'NoiseDensity',8.7266e-05, ...
    'TemperatureBias',0.34907, ...
    'TemperatureScaleFactor',0.02, ...
    'AccelerationBias',0.00017809, ...
    'ConstantBias',[0.3491,0.5,0]);

orientationDefault = zeros(numSamples,1,'quaternion');
for i = 1:numSamples

    [accelBody,gyroBody] = IMU(accNED(i,:),angVelNED(i,:),orientationNED(i,:));

```

```

    orientationDefault(i) = aFilter(accelBody,gyroBody);
end
release(aFilter)

figure(2)
plot(t,eulerd(orientationDefault,'ZYX','frame'))
xlabel('Time (s)')
ylabel('Rotation (degrees)')
title('Orientation Estimation -- Realistic IMU Data, Default IMU Filter')
legend('Z-axis','Y-axis','X-axis')

```

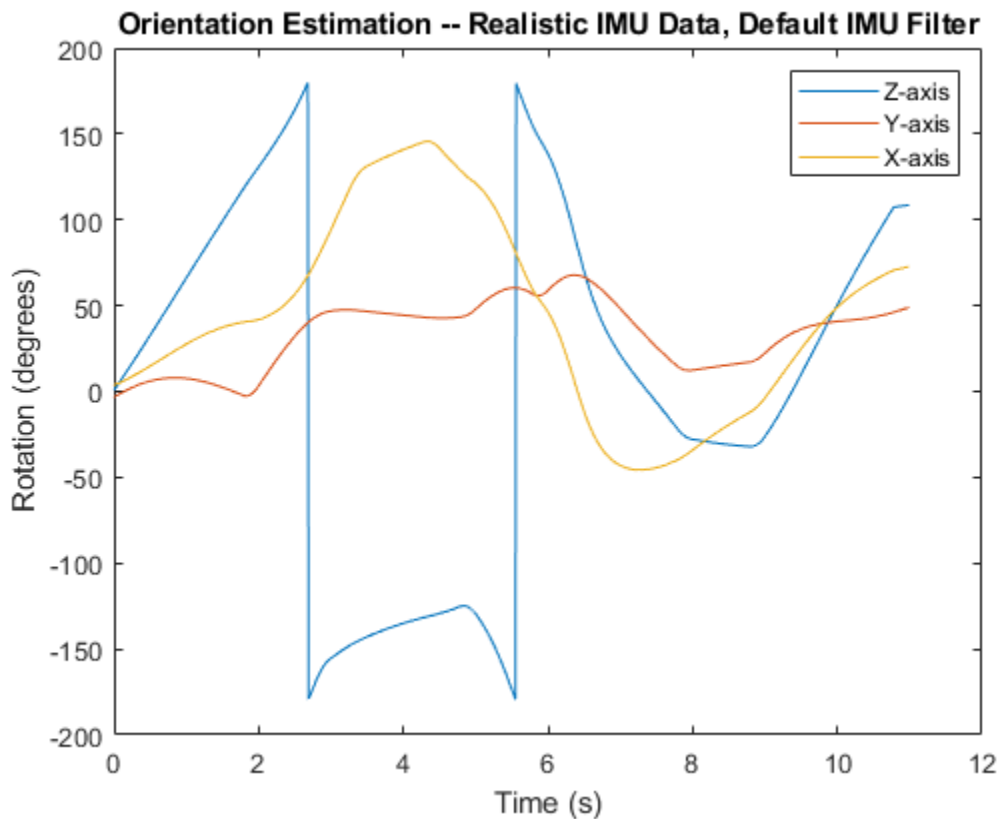

The ability of the `imufilter` to track the ground-truth data is significantly reduced when modeling a realistic IMU. To improve performance, modify properties of your `imufilter` object. These values were determined empirically. Run the loop again and plot the orientation estimate over time.

```

aFilter.GyroscopeNoise      = 7.6154e-7;
aFilter.AccelerometerNoise  = 0.0015398;
aFilter.GyroscopeDriftNoise = 3.0462e-12;
aFilter.LinearAccelerationNoise = 0.00096236;
aFilter.InitialProcessNoise = aFilter.InitialProcessNoise*10;

orientationNondefault = zeros(numSamples,1,'quaternion');
for i = 1:numSamples
    [accelBody,gyroBody] = IMU(accNED(i,:),angVelNED(i,:),orientationNED(i,:));

    orientationNondefault(i) = aFilter(accelBody,gyroBody);
end

```

```

end
release(aFilter)

figure(3)
plot(t,eulerd(orientationNondefault,'ZYX','frame'))
xlabel('Time (s)')
ylabel('Rotation (degrees)')
title('Orientation Estimation -- Realistic IMU Data, Nondefault IMU Filter')
legend('Z-axis','Y-axis','X-axis')

```

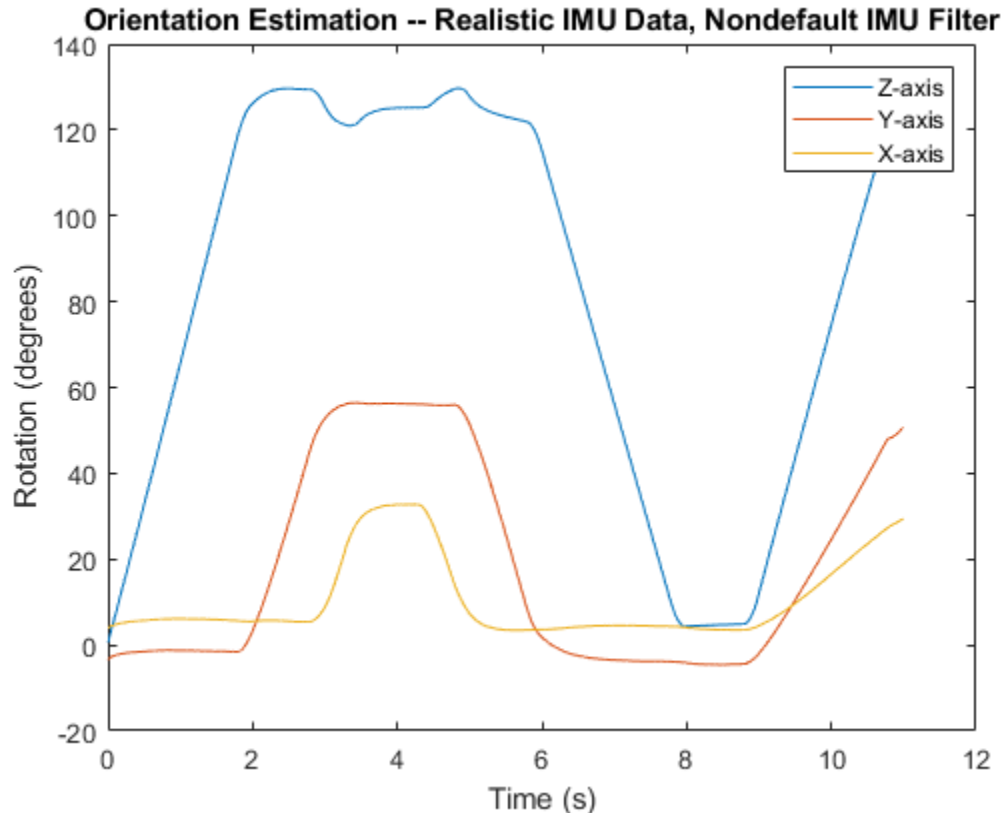

To quantify the improved performance of the modified `imufilter`, plot the quaternion distance between the ground-truth motion and the orientation as returned by the `imufilter` with default and nondefault properties.

```

qDistDefault = rad2deg(dist(orientationNED,orientationDefault));
qDistNondefault = rad2deg(dist(orientationNED,orientationNondefault));

```

```

figure(4)
plot(t,[qDistDefault,qDistNondefault])
title('Quaternion Distance from True Orientation')
legend('Realistic IMU Data, Default IMU Filter', ...
       'Realistic IMU Data, Nondefault IMU Filter')
xlabel('Time (s)')
ylabel('Quaternion Distance (degrees)')

```

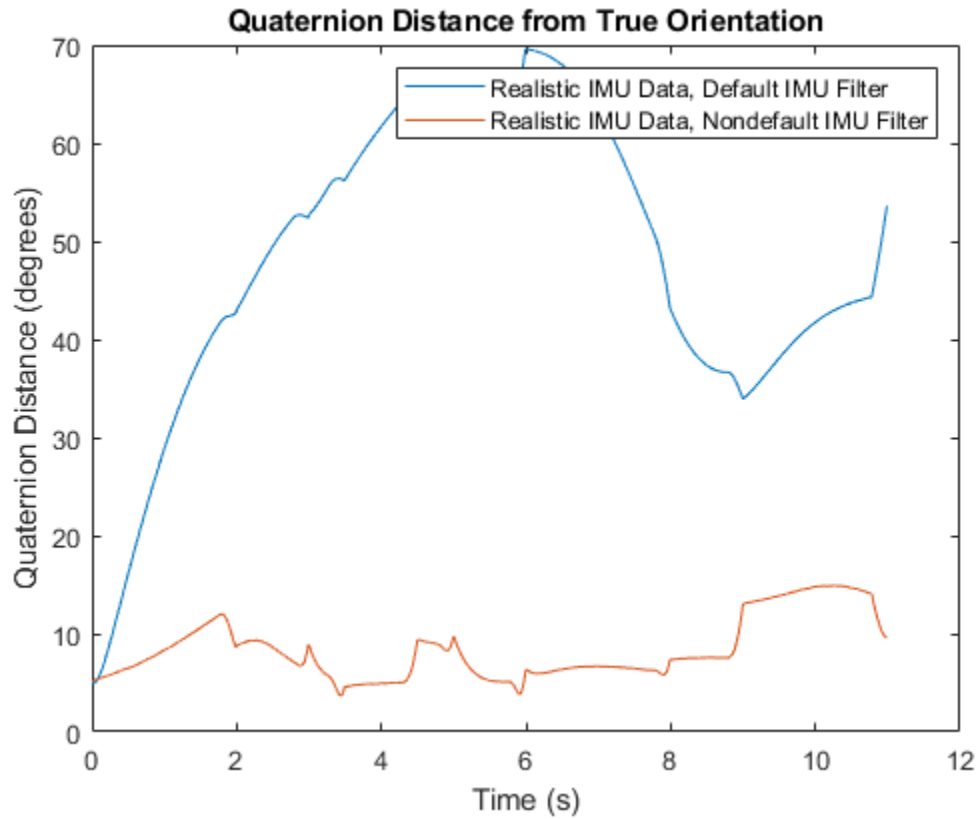
Algorithms

Accelerometer

The accelerometer model uses the ground-truth orientation and acceleration inputs and the `imuSensor` and `accelParams` properties to model accelerometer readings.

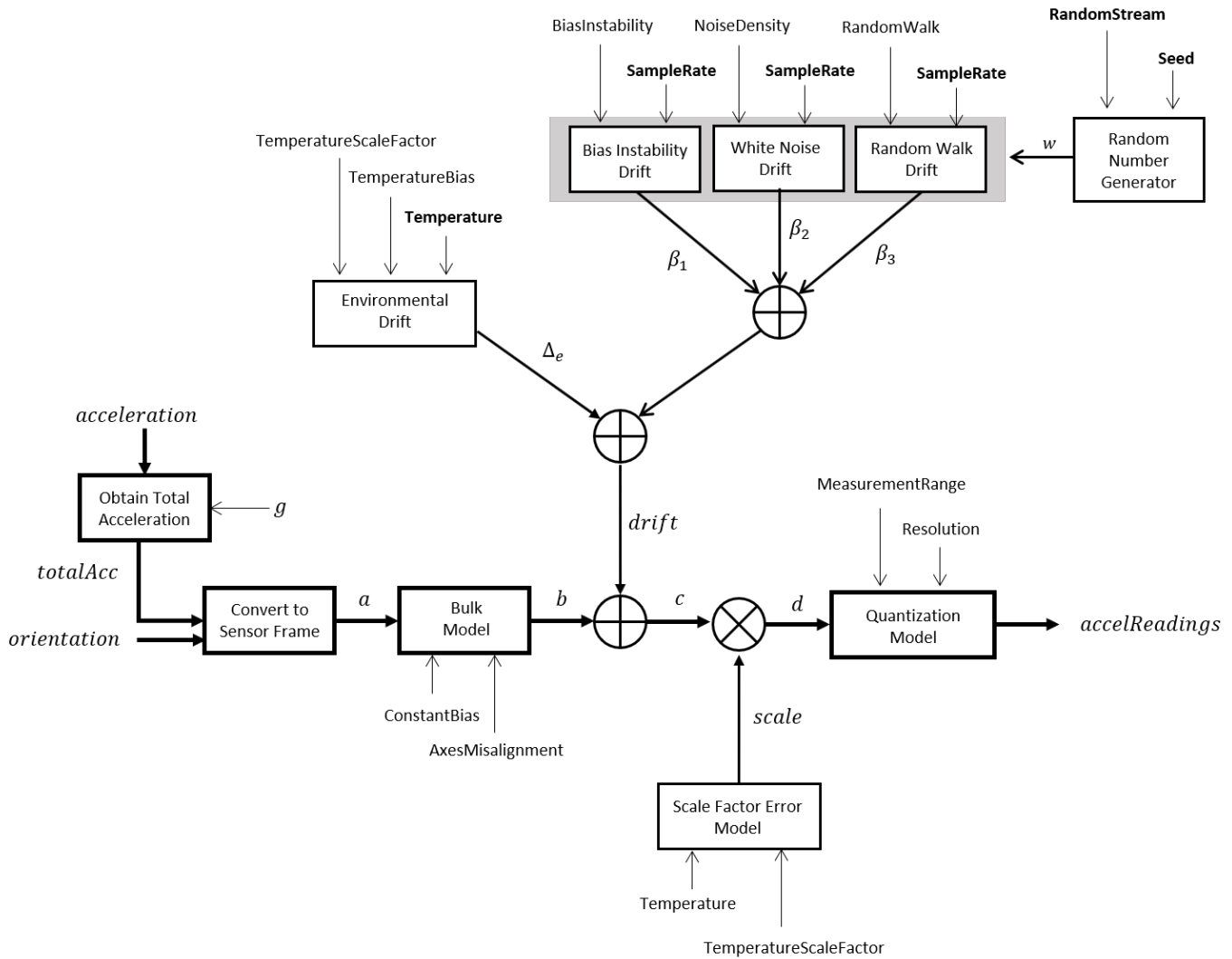

Obtain Total Acceleration

To obtain the total acceleration (*totalAcc*), the acceleration is preprocessed by negating and adding the gravity constant vector ($g = [0; 0; 9.8]$ m/s²) as:

$$totalAcc = -acceleration + g$$

Convert to Sensor Frame

Then the total acceleration is converted from the local navigation frame to the sensor frame using:

$$a = (orientation)(totalAcc)^T$$

If the orientation is input in quaternion form, it is converted to a rotation matrix before processing.

Bulk Model

The ground-truth acceleration in the sensor frame, a , passes through the bulk model, which adds axes misalignment and bias:

$$b = \left(\begin{bmatrix} 1 & \frac{\alpha_2}{100} & \frac{\alpha_3}{100} \\ \frac{\alpha_1}{100} & 1 & \frac{\alpha_3}{100} \\ \frac{\alpha_1}{100} & \frac{\alpha_2}{100} & 1 \end{bmatrix} (a^T) \right)^T + \text{ConstantBias}$$

where ConstantBias is a property of `accelparams`, and α_1 , α_2 , and α_3 are given by the first, second, and third elements of the AxesMisalignment property of `accelparams`.

Bias Instability Drift

The bias instability drift is modeled as white noise biased and then filtered:

$$\beta_1 = h_1 * (w)(\text{BiasInstability})$$

where BiasInstability is a property of `accelparams`, and h_1 is a filter defined by the SampleRate property:

$$H_1(z) = \frac{1}{1 - \frac{1}{2}z^{-1}}$$

White Noise Drift

White noise drift is modeled by multiplying elements of the white noise random stream by the standard deviation:

$$\beta_2 = (w) \left(\sqrt{\frac{\text{SampleRate}}{2}} \right) (\text{NoiseDensity})$$

where SampleRate is an `imuSensor` property, and NoiseDensity is an `accelparams` property. Elements of w are random numbers given by settings of the `imuSensor` random stream.

Random Walk Drift

The random walk drift is modeled by biasing elements of the white noise random stream and then filtering:

$$\beta_3 = h_2 * (w) \left(\frac{\text{RandomWalk}}{\sqrt{\frac{\text{SampleRate}}{2}}} \right)$$

where RandomWalk is a property of `accelparams`, SampleRate is a property of `imuSensor`, and h_2 is a filter defined as:

$$H_2(z) = \frac{1}{1 - z^{-1}}$$

Environmental Drift Noise

The environmental drift noise is modeled by multiplying the temperature difference from a standard with the temperature bias:

$$\Delta_e = (\text{Temperature} - 25)(\text{TemperatureBias})$$

where `Temperature` is a property of `imuSensor`, and `TemperatureBias` is a property of `accelParams`. The constant 25 corresponds to a standard temperature.

Scale Factor Error Model

The temperature scale factor error is modeled as:

$$scaleFactorError = 1 + \left(\frac{Temperature - 25}{100} \right) (TemperatureScaleFactor)$$

where `Temperature` is a property of `imuSensor`, and `TemperatureScaleFactor` is a property of `accelParams`. The constant 25 corresponds to a standard temperature.

Quantization Model

The quantization is modeled by first saturating the continuous signal model:

$$e = \begin{cases} \text{MeasurementRange} & \text{if } d > \text{MeasurementRange} \\ -\text{MeasurementRange} & \text{if } -d > \text{MeasurementRange} \\ d & \text{else} \end{cases}$$

and then setting the resolution:

$$accelReadings = (\text{Resolution}) \left(\text{round} \left(\frac{e}{\text{Resolution}} \right) \right)$$

where `MeasurementRange` is a property of `accelParams`.

Gyroscope

The gyroscope model uses the ground-truth orientation, acceleration, and angular velocity inputs, and the `imuSensor` and `gyroParams` properties to model accelerometer readings.

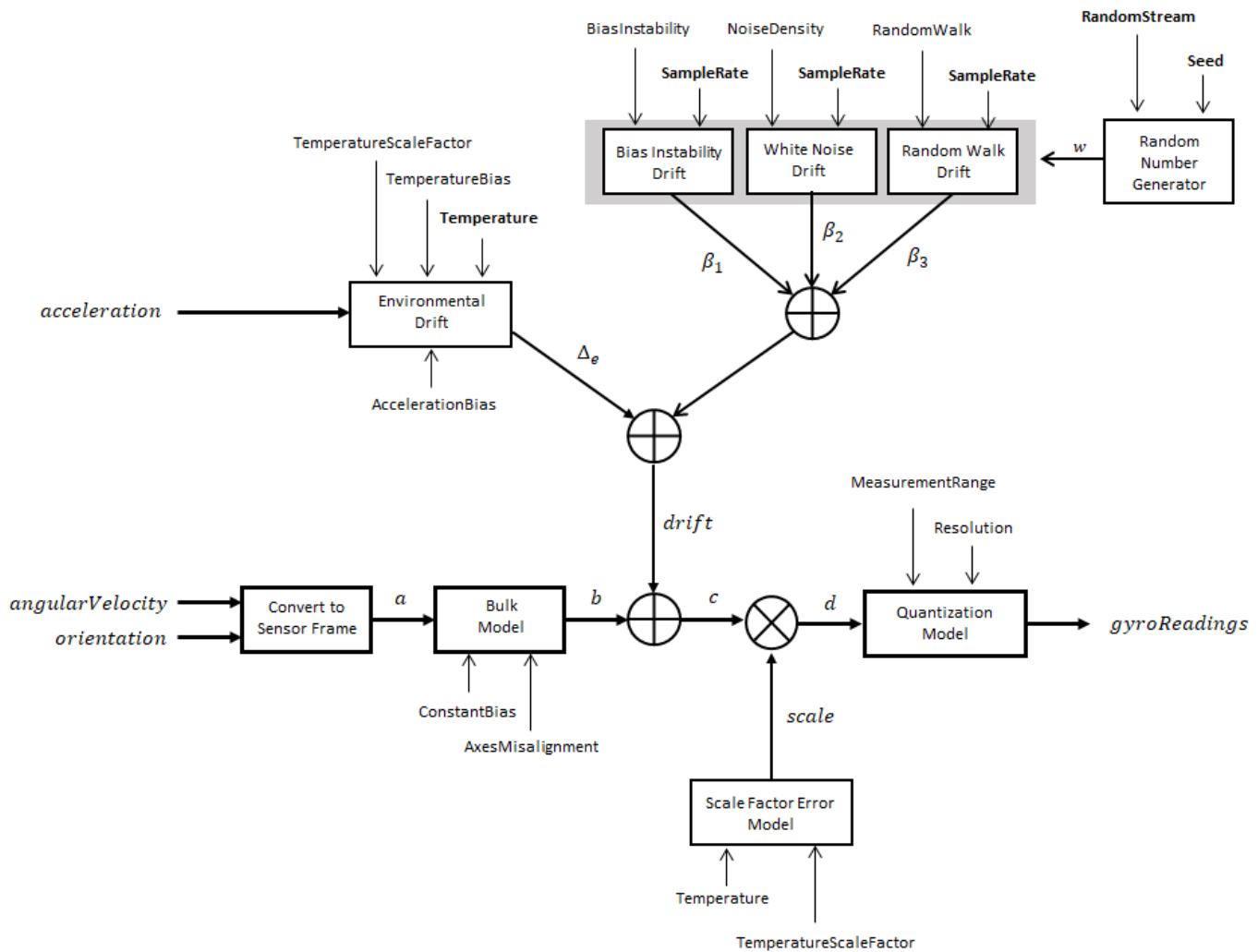

Convert to Sensor Frame

The ground-truth angular velocity is converted from the local frame to the sensor frame using the ground-truth orientation:

$$a = (\textit{orientation})(\textit{angularVelocity})^T$$

If the orientation is input in quaternion form, it is converted to a rotation matrix before processing.

Bulk Model

The ground-truth angular velocity in the sensor frame, *a*, passes through the bulk model, which adds axes misalignment and bias:

$$b = \left(\begin{bmatrix} 1 & \frac{\alpha_2}{100} & \frac{\alpha_3}{100} \\ \frac{\alpha_1}{100} & 1 & \frac{\alpha_3}{100} \\ \frac{\alpha_1}{100} & \frac{\alpha_2}{100} & 1 \end{bmatrix} (a^T) \right)^T + \text{ConstantBias}$$

where ConstantBias is a property of `gyroparams`, and α_1 , α_2 , and α_3 are given by the first, second, and third elements of the AxesMisalignment property of `gyroparams`.

Bias Instability Drift

The bias instability drift is modeled as white noise biased and then filtered:

$$\beta_1 = h_1 * (w)(\text{BiasInstability})$$

where BiasInstability is a property of `gyroparams` and h_1 is a filter defined by the SampleRate property:

$$H_1(z) = \frac{1}{1 - \frac{1}{2}z^{-1}}$$

White Noise Drift

White noise drift is modeled by multiplying elements of the white noise random stream by the standard deviation:

$$\beta_2 = (w) \left(\sqrt{\frac{\text{SampleRate}}{2}} \right) (\text{NoiseDensity})$$

where SampleRate is an `imuSensor` property, and NoiseDensity is an `gyroparams` property. The elements of w are random numbers given by settings of the `imuSensor` random stream.

Random Walk Drift

The random walk drift is modeled by biasing elements of the white noise random stream and then filtering:

$$\beta_3 = h_2 * (w) \left(\frac{\text{RandomWalk}}{\sqrt{\frac{\text{SampleRate}}{2}}} \right)$$

where RandomWalk is a property of `gyroparams`, SampleRate is a property of `imuSensor`, and h_2 is a filter defined as:

$$H_2(z) = \frac{1}{1 - z^{-1}}$$

Environmental Drift Noise

The environmental drift noise is modeled by multiplying the temperature difference from a standard with the temperature bias:

$$\Delta_e = (\text{Temperature} - 25)(\text{TemperatureBias})$$

where `Temperature` is a property of `imuSensor`, and `TemperatureBias` is a property of `gyroParams`. The constant 25 corresponds to a standard temperature.

Scale Factor Error Model

The temperature scale factor error is modeled as:

$$scaleFactorError = 1 + \left(\frac{Temperature - 25}{100} \right) (TemperatureScaleFactor)$$

where `Temperature` is a property of `imuSensor`, and `TemperatureScaleFactor` is a property of `gyroParams`. The constant 25 corresponds to a standard temperature.

Quantization Model

The quantization is modeled by first saturating the continuous signal model:

$$e = \begin{cases} \text{MeasurementRange} & \text{if } d > \text{MeasurementRange} \\ -\text{MeasurementRange} & \text{if } -d > \text{MeasurementRange} \\ d & \text{else} \end{cases}$$

and then setting the resolution:

$$gyroReadings = (\text{Resolution}) \left(\text{round} \left(\frac{e}{\text{Resolution}} \right) \right)$$

where `MeasurementRange` is a property of `gyroParams`.

Magnetometer

The magnetometer model uses the ground-truth orientation and acceleration inputs, and the `imuSensor` and `magParams` properties to model magnetometer readings.

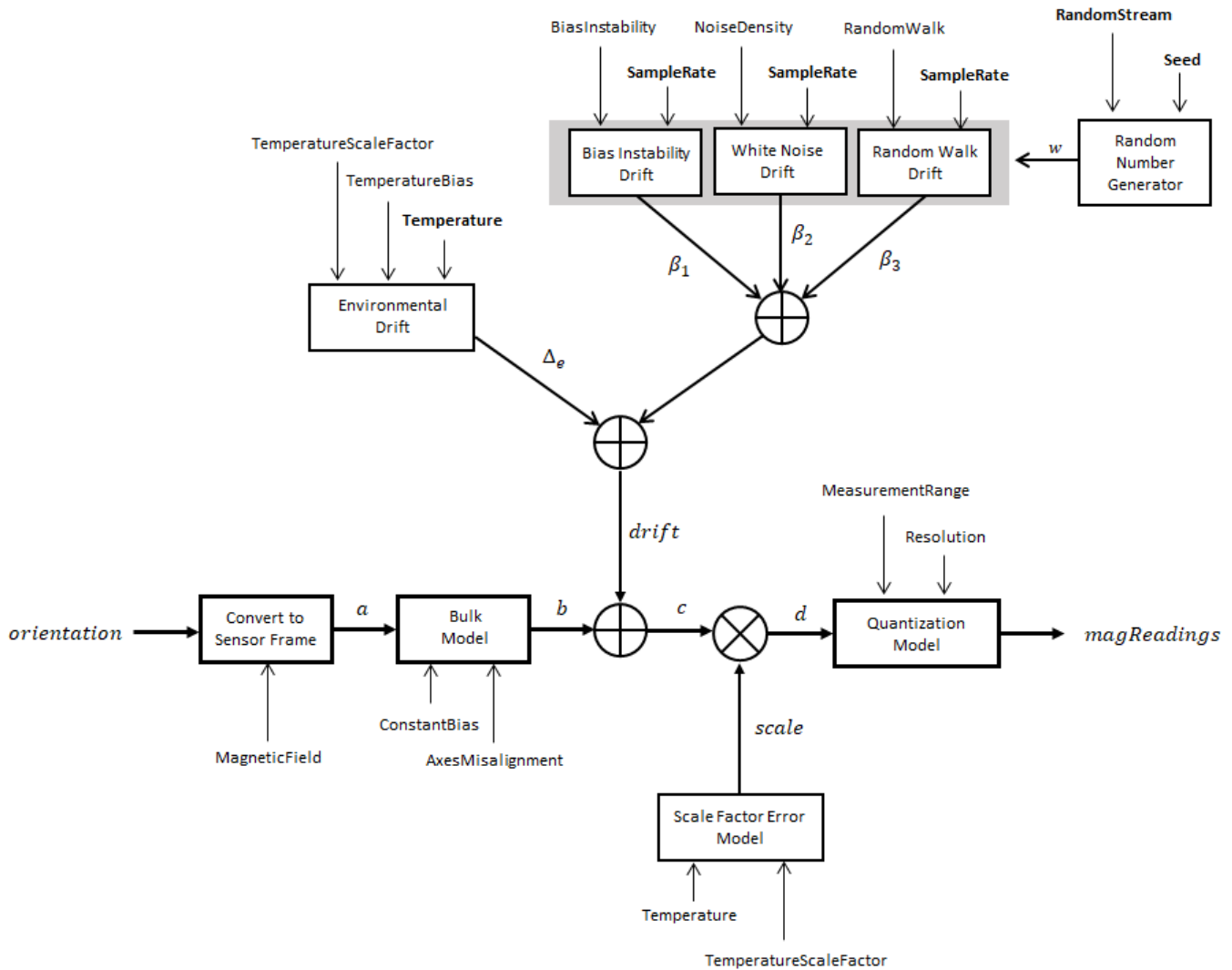

Convert to Sensor Frame

The ground-truth acceleration is converted from the local frame to the sensor frame using the ground-truth orientation:

$$a = (orientation)(totalAcc)^T$$

If the orientation is input in quaternion form, it is converted to a rotation matrix before processing.

Bulk Model

The ground-truth acceleration in the sensor frame, *a*, passes through the bulk model, which adds axes misalignment and bias:

$$b = \left(\begin{bmatrix} 1 & \frac{\alpha_2}{100} & \frac{\alpha_3}{100} \\ \frac{\alpha_1}{100} & 1 & \frac{\alpha_3}{100} \\ \frac{\alpha_1}{100} & \frac{\alpha_2}{100} & 1 \end{bmatrix} (a^T) \right)^T + \text{ConstantBias}$$

where ConstantBias is a property of magparams, and α_1 , α_2 , and α_3 are given by the first, second, and third elements of the AxesMisalignment property of magparams.

Bias Instability Drift

The bias instability drift is modeled as white noise biased and then filtered:

$$\beta_1 = h_1 * (w)(\text{BiasInstability})$$

where BiasInstability is a property of magparams and h_1 is a filter defined by the SampleRate property:

$$H_1(z) = \frac{1}{1 - \frac{1}{2}z^{-1}}$$

White Noise Drift

White noise drift is modeled by multiplying elements of the white noise random stream by the standard deviation:

$$\beta_2 = (w) \left(\sqrt{\frac{\text{SampleRate}}{2}} \right) (\text{NoiseDensity})$$

where SampleRate is an imuSensor property, and NoiseDensity is an magparams property. The elements of w are random numbers given by settings of the imuSensor random stream.

Random Walk Drift

The random walk drift is modeled by biasing elements of the white noise random stream and then filtering:

$$\beta_3 = h_2 * (w) \left(\frac{\text{RandomWalk}}{\sqrt{\frac{\text{SampleRate}}{2}}} \right)$$

where RandomWalk is a property of magparams, SampleRate is a property of imuSensor, and h_2 is a filter defined as:

$$H_2(z) = \frac{1}{1 - z^{-1}}$$

Environmental Drift Noise

The environmental drift noise is modeled by multiplying the temperature difference from a standard with the temperature bias:

$$\Delta_e = (\text{Temperature} - 25)(\text{TemperatureBias})$$

where `Temperature` is a property of `imuSensor`, and `TemperatureBias` is a property of `magparams`. The constant 25 corresponds to a standard temperature.

Scale Factor Error Model

The temperature scale factor error is modeled as:

$$scaleFactorError = 1 + \left(\frac{Temperature - 25}{100} \right) (TemperatureScaleFactor)$$

where `Temperature` is a property of `imuSensor`, and `TemperatureScaleFactor` is a property of `magparams`. The constant 25 corresponds to a standard temperature.

Quantization Model

The quantization is modeled by first saturating the continuous signal model:

$$e = \begin{cases} \text{MeasurementRange} & \text{if } d > \text{MeasurementRange} \\ -\text{MeasurementRange} & \text{if } -d > \text{MeasurementRange} \\ d & \text{else} \end{cases}$$

and then setting the resolution:

$$magReadings = (\text{Resolution}) \left(\text{round} \left(\frac{e}{\text{Resolution}} \right) \right)$$

where `MeasurementRange` is a property of `magparams`.

Extended Capabilities

C/C++ Code Generation

Generate C and C++ code using MATLAB® Coder™.

Usage notes and limitations:

See “System Objects in MATLAB Code Generation” (MATLAB Coder).

See Also

Classes

`accelparams` | `gyroparams` | `magparams`

Objects

`gpsSensor` | `insSensor`

Topics

“Model IMU, GPS, and INS/GPS”

Introduced in R2018b

loadparams

Load sensor parameters from JSON file

Syntax

```
loadparams(sensor, file, PN)
```

Description

loadparams(sensor, file, PN) configures the imuSensor object, sensor, to match the parameters in the PN part of a JSON file, File.

Examples

Load Pre-defined Parameters in imuSensor

Create an imuSensor system object.

```
s = imuSensor;
```

Load a JSON file.

```
fn = fullfile(matlabroot, 'toolbox', 'shared', ...
    'positioning', 'positioningdata', 'generic.json');
```

Here is a screen shot of the JSON file with some parts collapsed.

```
{
  "GenericLowCost9Axis":
  {
    "Accelerometer":
    {
      "MeasurementRange": 19.6133,
      "Resolution": 0.0023928,
      "ConstantBias": [0.19,0.19,0.19],
      "AxesMisalignment": [0,0,0],
      "NoiseDensity": [0.0012356,0.0012356,0.0012356],
      "BiasInstability": [0,0,0],
      "RandomWalk": [0,0,0],
      "TemperatureBias": [0,0,0],
      "TemperatureScaleFactor": [0,0,0]
    },
    "Gyroscope":
    { [collapsed] },
    "Magnetometer":
    { [collapsed] }
  },
  "GenericLowCost6Axis":
  { [collapsed] }
}
```

Configure the object as a 6-axis sensor.

```
loadparams(s, fn, 'GenericLowCost6Axis')
s
s =
  imuSensor with properties:
    IMUType: 'accel-gyro'
    SampleRate: 100
    Temperature: 25
    Accelerometer: [1x1 accelparams]
    Gyroscope: [1x1 gyroparams]
    RandomStream: 'Global stream'
```

Configure the object as a 9-axis sensor.

```
loadparams(s, fn, 'GenericLowCost9Axis')
s
s =
  imuSensor with properties:
    IMUType: 'accel-gyro-mag'
    SampleRate: 100
    Temperature: 25
    MagneticField: [27.5550 -2.4169 -16.0849]
    Accelerometer: [1x1 accelparams]
    Gyroscope: [1x1 gyroparams]
    Magnetometer: [1x1 magparams]
    RandomStream: 'Global stream'
```

Input Arguments

sensor – IMU sensor

imuSensor object

IMU sensor, specified as an imuSensor system object.

file – JSON file

.json file

JavaScript Object Notation (JSON) format file, specified as a .json file.

PN – Part name

string

Part name in a JSON file, specified as a string.

See Also

imuSensor

Introduced in R2020a

trackBranchHistory

Track-oriented MHT branching and branch history

Description

The `trackBranchHistory` System object is a track-oriented, multi-hypothesis tracking (MHT) branch history manager. The object maintains a history of track branches (hypotheses) that are based on the results of an assignment algorithm, such as the algorithm used by the `assignTOMHT` function. Given the most recent scan of a set of sensors, the assignment algorithm results include:

- The assignments of sensor detections to specific track branches
- The unassigned track branches
- The unassigned detections

The `trackBranchHistory` object creates, updates, and deletes track branches as needed and maintains the track branch history for a specified number of scans. Each track and branch stored in the object has a unique ID. To view a table of track branches for the current history, use the `getHistory` function. To compute branch clusters and incompatible branches, specify the track branch history as an input to the `clusterTrackBranches` function.

To create a branch history manager and update the branch history:

- 1 Create the `trackBranchHistory` object and set its properties.
- 2 Call the object with arguments, as if it were a function.

To learn more about how System objects work, see [What Are System Objects?](#).

Creation

Syntax

```
branchHistoryMgr = trackBranchHistory  
branchHistoryMgr = trackBranchHistory(Name,Value)
```

Description

`branchHistoryMgr = trackBranchHistory` creates a `trackBranchHistory` System object, `branchHistoryMgr`, with default property values.

`branchHistoryMgr = trackBranchHistory(Name,Value)` sets properties for the `trackBranchHistory` object by using one or more name-value pairs. For example, `branchHistoryMgr = trackBranchHistory('MaxNumTracks',250,'MaxNumTrackBranches',5)` creates a `trackBranchHistory` object that can maintain a maximum of 250 tracks and 5 track branches per track. Enclose property names in quotes. Specified property values can be any numeric data type, but they must all be of the same data type.

Properties

Unless otherwise indicated, properties are *nontunable*, which means you cannot change their values after calling the object. Objects lock when you call them, and the `release` function unlocks them.

If a property is *tunable*, you can change its value at any time.

For more information on changing property values, see System Design in MATLAB Using System Objects.

MaxNumSensors — Maximum number of sensors

20 (default) | positive integer

Maximum number of sensors, specified as a positive integer.

MaxNumHistoryScans — Maximum number of scans maintained in branch history

4 (default) | positive integer

Maximum number of scans maintained in the branch history, specified as a positive integer. Typical values are from 2 to 6. Higher values increase the computational load.

MaxNumTracks — Maximum number of tracks

200 (default) | positive integer

Maximum number of tracks that the branch history manager can maintain, specified as a positive integer.

MaxNumTrackBranches — Maximum number of branches per track

3 (default) | positive integer

Maximum number of branches per track that the branch history manager can maintain, specified as a positive integer.

Usage

Syntax

```
history = branchHistoryMgr(assignments,unassignedTracks,unassignedDetections,  
originatingSensor)
```

Description

`history = branchHistoryMgr(assignments,unassignedTracks,unassignedDetections,originatingSensor)` returns the branch history based on the results of an assignment algorithm. Specify the assignments of detections to branches, the lists of unassigned tracks and unassigned detections, and the IDs of the sensors from which the detections originated. The inputs can be of any numeric data type.

The `assignTOMHT` function returns assignment results as `uint32` values, but the inputs to `branchHistoryMgr` can be of any numeric data type.

Input Arguments

assignments — Assignment of track branches to detections

P-by-2 matrix of integers

Assignment of track branches to detections, specified as a *P*-by-2 matrix of integers, where *P* is the number of assignments. The first column lists the track branch indices. The second column lists the detection indices. The same branch can be assigned to multiple detections. The same detection can be assigned to multiple branches.

For example, if `assignments = [1 1; 1 2; 2 1; 2 2]`, the rows of `assignments` specify these assignments:

- [1 1] — Branch 1 was assigned to detection 1.
- [1 2] — Branch 1 was assigned to detection 2.
- [2 1] — Branch 2 was assigned to detection 1.
- [2 2] — Branch 2 was assigned to detection 2.

unassignedTracks — Indices of unassigned track branches

Q-by-1 vector of integers

Indices of unassigned track branches, specified as a *Q*-by-1 vector of integers, where *Q* is the number of unassigned track branches. Each element of `unassignedTracks` must correspond to the indices of a track branch currently stored in the `trackBranchHistory` System object.

unassignedDetections — Indices of unassigned detections

R-by-1 vector of integers

Indices of unassigned detections, specified as an *R*-by-1 vector of integers, where *R* is the number of unassigned detections. Each unassigned detection results in a new track branch.

originatingSensor — Indices of sensors from which each detection originated

1-by-*L* vector of integers

Indices of sensors from which each detection originated, specified as a 1-by-*L* vector of integers, where *L* is the number of detections. The *i*th element of `originatingSensor` corresponds to the `SensorIndex` property value of `objectDetection` object *i*.

Output Arguments

history — Branch history

matrix of integers

Branch history, returned as a matrix of integers.

Each row of `history` represents a unique track branch. `history` has $3+(D \times S)$ columns, where *D* is the number of maintained scans (the history depth) and *S* is the maximum number of maintained sensors. The first three columns represent the following information about each track branch:

- **TrackID** — ID of the track that is associated with the branch. Track branches that are assumed to have originated from the same target have the same track ID. If a branch originates from an unassigned detection, that branch gets a new track ID.
- **ParentID** — ID of the parent branch, that is, the branch from which the current branch originated. Branches that were created from the same parent have the same `ParentID`. A

ParentID of 0 indicates a new track. These tracks are created from hypotheses corresponding to unassigned detections.

- **BranchID** — Unique ID of track branch. Every branch created from an unassigned detection or assignment gets a new branch ID.

The remaining $D \times S$ columns contain the IDs of the detections assigned to each branch. A branch can be assigned to at most one detection per scan and per sensor. The table shows the organization of these columns with sample detections. N is the number of scans. A value of 0 means that the sensor at that scan does not have a detection assigned to it.

Scan N				Scan $N - 1$...	Scan $N - D$			
Senso $r - 1$	Senso $r - 2$...	Senso $r - S$	Senso $r - 1$	Senso $r - 2$...	Senso $r - S$...	Senso $r - 1$	Senso $r - 2$...	Senso $r - S$
1	0	...	0	1	2	...	0	...	0	0	...	0

Object Functions

To use an object function, specify the System object as the first input argument. For example, to release system resources of a System object named `obj`, use this syntax:

```
release(obj)
```

Specific to trackBranchHistory

`getHistory` Get branch history of maintained tracks

Common to All System Objects

`step` Run System object algorithm
`release` Release resources and allow changes to System object property values and input characteristics
`reset` Reset internal states of System object

Examples

Branch Tracks Based on Assignment Results

Apply the results of an assignment algorithm to a track-oriented, multi-hypothesis tracking (MHT) branch history manager. View the resulting track branches (hypotheses).

Create the MHT branch history manager, which is a `trackBranchHistory` System object™. Set the object to maintain a history of four sensors and two scans.

```
branchHistoryMgr = trackBranchHistory('MaxNumSensors',4,'MaxNumHistoryScans',2)
```

```
branchHistoryMgr =  
    trackBranchHistory with properties:
```

```
        MaxNumSensors: 4  
        MaxNumHistoryScans: 2  
        MaxNumTracks: 200  
        MaxNumTrackBranches: 3
```

Update the branch history. Because the first update has no previous branches, the branch history manager contains only unassigned detections.

```
emptyAssignment = zeros(0,2,'uint32');
emptyUnassignment = zeros(0,1,'uint32');
unassignedDetections = uint32([1;2;3]);
originatingSensor = [1 1 2];
history = branchHistoryMgr(emptyAssignment,emptyUnassignment, ...
    unassignedDetections,originatingSensor);
```

View the current branch history by using the `getHistory` function. Each detection is assigned to a separate track.

```
getHistory(branchHistoryMgr)
```

ans=3x5 table

TrackID	ParentID	BranchID	Scan2				Sensor1	Sensor2	Sensor3	Sensor4
1	0	1	1	0	0	0	0	0	0	
2	0	2	2	0	0	0	0	0	0	
3	0	3	0	3	0	0	0	0	0	

Specify multiple branch assignments and multiple unassigned track branches and detections.

- Assign branch 1 to detections 1 and 2.
- Assign branch 2 to detections 1 and 2.
- Consider track branches 1 and 3 unassigned.
- Consider detections 1, 2, and 3 unassigned.

```
assignments = uint32([1 1; 1 2; 2 1; 2 2]);
unassignedTracks = uint32([1;3]);
unassignedDetections = uint32([1;2;3]);
```

Update the branch history manager with the assignments and unassigned tracks and detections.

```
history = branchHistoryMgr(assignments,unassignedTracks, ...
    unassignedDetections,originatingSensor);
```

View the updated branch history.

```
getHistory(branchHistoryMgr)
```

ans=9x5 table

TrackID	ParentID	BranchID	Scan2				Sensor1	Sensor2	Sensor3	Sensor4
1	1	1	0	0	0	0	0	0	1	
3	3	3	0	0	0	0	0	0	0	
4	0	4	1	0	0	0	0	0	0	
5	0	5	2	0	0	0	0	0	0	
6	0	6	0	3	0	0	0	0	0	
1	1	7	1	0	0	0	0	0	1	
1	1	8	2	0	0	0	0	0	1	

2	2	9	1	0	0	0	2
2	2	10	2	0	0	0	2

Inspect the branch history.

- The most recent scan is Scan 2. The previous scan is Scan 1, which was Scan 2 in the previous assignment update. The history has shifted one scan to the right.
- Branches 1 and 3 are the branches for the unassigned tracks.
- Branch 2 is no longer in the history because it was not considered to be unassigned. Its assignment to detections 1 and 2 created branches 9 and 10.
- Branches 4-6 are branches created for the unassigned detections.
- Branches 7-10 are branches created for the track assignments.

References

- [1] Werthmann, John R. "A Step-by-Step Description of a Computationally Efficient Version of Multiple Hypothesis Tracking." In *Proceedings of SPIE Vol. 1698, Signal and Processing of Small Targets*. 1992, pp. 288-300. doi: 10.1117/12.139379.

See Also

Functions

`assignTOMHT` | `clusterTrackBranches` | `trackerTOMHT`

Introduced in R2018b

getHistory

Get branch history of maintained tracks

Syntax

```
history = getHistory(branchHistoryMgr)
history = getHistory(branchHistoryMgr, format)
```

Description

`history = getHistory(branchHistoryMgr)` returns a table containing the track branch history maintained by the input `trackBranchHistory` System object, `branchHistoryMgr`.

`history = getHistory(branchHistoryMgr, format)` returns the branch history in the specified format: 'table' or 'matrix'.

Examples

Branch Tracks Based on Assignment Results

Apply the results of an assignment algorithm to a track-oriented, multi-hypothesis tracking (MHT) branch history manager. View the resulting track branches (hypotheses).

Create the MHT branch history manager, which is a `trackBranchHistory` System object™. Set the object to maintain a history of four sensors and two scans.

```
branchHistoryMgr = trackBranchHistory('MaxNumSensors',4,'MaxNumHistoryScans',2)
```

```
branchHistoryMgr =  
    trackBranchHistory with properties:
```

```
    MaxNumSensors: 4  
    MaxNumHistoryScans: 2  
    MaxNumTracks: 200  
    MaxNumTrackBranches: 3
```

Update the branch history. Because the first update has no previous branches, the branch history manager contains only unassigned detections.

```
emptyAssignment = zeros(0,2,'uint32');  
emptyUnassignment = zeros(0,1,'uint32');  
unassignedDetections = uint32([1;2;3]);  
originatingSensor = [1 1 2];  
history = branchHistoryMgr(emptyAssignment,emptyUnassignment, ...  
    unassignedDetections,originatingSensor);
```

View the current branch history by using the `getHistory` function. Each detection is assigned to a separate track.

```
getHistory(branchHistoryMgr)
```

```

ans=3x5 table
  TrackID  ParentID  BranchID  Sensor1  Scan2  Sensor3  Sensor4  Sensor1  Sen
-----
      1      0      1      1      0      0      0      0
      2      0      2      2      0      0      0      0
      3      0      3      0      3      0      0      0

```

Specify multiple branch assignments and multiple unassigned track branches and detections.

- Assign branch 1 to detections 1 and 2.
- Assign branch 2 to detections 1 and 2.
- Consider track branches 1 and 3 unassigned.
- Consider detections 1, 2, and 3 unassigned.

```

assignments = uint32([1 1; 1 2; 2 1; 2 2]);
unassignedTracks = uint32([1;3]);
unassignedDetections = uint32([1;2;3]);

```

Update the branch history manager with the assignments and unassigned tracks and detections.

```

history = branchHistoryMgr(assignments,unassignedTracks, ...
    unassignedDetections,originatingSensor);

```

View the updated branch history.

```

getHistory(branchHistoryMgr)

```

```

ans=9x5 table
  TrackID  ParentID  BranchID  Sensor1  Scan2  Sensor3  Sensor4  Sensor1  Sen
-----
      1      1      1      0      0      0      0      1
      3      3      3      0      0      0      0      0
      4      0      4      1      0      0      0      0
      5      0      5      2      0      0      0      0
      6      0      6      0      3      0      0      0
      1      1      7      1      0      0      0      1
      1      1      8      2      0      0      0      1
      2      2      9      1      0      0      0      2
      2      2     10      2      0      0      0      2

```

Inspect the branch history.

- The most recent scan is Scan 2. The previous scan is Scan 1, which was Scan 2 in the previous assignment update. The history has shifted one scan to the right.
- Branches 1 and 3 are the branches for the unassigned tracks.
- Branch 2 is no longer in the history because it was not considered to be unassigned. Its assignment to detections 1 and 2 created branches 9 and 10.
- Branches 4-6 are branches created for the unassigned detections.
- Branches 7-10 are branches created for the track assignments.

Input Arguments

branchHistoryMgr — Input branch history manager

trackBranchHistory System object

Input branch history manager, specified as a trackBranchHistory System object.

format — Format of output branch history

'table' (default) | 'matrix'

Format of the output branch history, specified as one of the following:

- 'table' (default) — Return branch history in a table.
- 'matrix' — Return branch history in a matrix. This output is equivalent to the output returned when calling the trackBranchHistory System object.

Output Arguments

history — Branch history

table of integers | matrix of integers

Branch history, returned as a table of integers or as a matrix of integers.

Each row of `history` represents a unique track branch. `history` has $3+(D \times S)$ columns, where D is the number of maintained scans (the history depth) and S is the maximum number of maintained sensors. The first three columns represent the following information about each track branch:

- **TrackID** — ID of the track that is associated with the branch. Track branches that are assumed to have originated from the same target have the same track ID. If a branch originates from an unassigned detection, that branch gets a new track ID.
- **ParentID** — ID of the parent branch, that is, the branch from which the current branch originated. Branches that were created from the same parent have the same **ParentID**. A **ParentID** of 0 indicates a new track. These tracks are created from hypotheses corresponding to unassigned detections.
- **BranchID** — Unique ID of track branch. Every branch created from an unassigned detection or assignment gets a new branch ID.

The remaining $D \times S$ columns contain the IDs of the detections assigned to each branch. A branch can be assigned to at most one detection per scan and per sensor. The table shows the organization of these columns with sample detections. N is the number of scans. A value of 0 means that the sensor at that scan does not have a detection assigned to it.

Scan N				Scan $N - 1$...	Scan $N - D$			
Senso $r - 1$	Senso $r - 2$...	Senso $r - S$	Senso $r - 1$	Senso $r - 2$...	Senso $r - S$...	Senso $r - 1$	Senso $r - 2$...	Senso $r - S$
1	0	...	0	1	2	...	0	...	0	0	...	0

See Also

trackBranchHistory

Introduced in R2018b

staticDetectionFuser

Static fusion of synchronous sensor detections

Description

`staticDetectionFuser` System object creates a static detection fuser object to fuse angle-only sensor detections.

To obtain the fuser:

- 1 Create the `staticDetectionFuser` object and set its properties.
- 2 Call the object with arguments, as if it were a function.

To learn more about how System objects work, see [What Are System Objects?](#).

Creation

Syntax

```
fuser = staticDetectionFuser()  
fuser = staticDetectionFuser(Name,Value)
```

Description

`fuser = staticDetectionFuser()` creates a default three-sensor static detection fuser object to fuse angle-only sensor detections.

`fuser = staticDetectionFuser(Name,Value)` sets properties using one or more name-value pairs. For example, `fuser = staticDetectionFuser('FalseAlarmRate',1e-6,'MaxNumSensors',12)` creates a fuser that has a maximum of 12 sensors and a false alarm rate of $1e-6$. Enclose each property name in quotes.

Properties

Unless otherwise indicated, properties are *nontunable*, which means you cannot change their values after calling the object. Objects lock when you call them, and the `release` function unlocks them.

If a property is *tunable*, you can change its value at any time.

For more information on changing property values, see [System Design in MATLAB Using System Objects](#).

FuserSensorIndex — Sensor index of composite detections

1 (default) | positive integer

Sensor index of the composite detections reported by the fuser, specified as a positive integer. This index becomes the `SensorIndex` of `objectDetection` objects returned by the fuser.

Example: 5

Data Types: double

MeasurementFusionFcn — Function for fusing multiple sensor detections

'triangulateLOS' (default) | char | string | function handle

Function for fusing multiple sensor detections, specified as a character vector, string, or function handle. The function fuses multiple detections into one and returns the fused measurement and measurement noise. Any fusing function combines at most one detection from each sensor. The syntax of the measurement fuser function is:

```
[fusedMeasurement, fusedMeasurementNoise] = MeasurementFusionFcn(detections)
```

where the input and output functions arguments are

- `detections` - cell array of `objectDetection` measurements.
- `fusedMeasurement` - an N -by-1 vector of fused measurements.
- `fusedMeasurementNoise` - an N -by- N matrix of fused measurements noise.

The value of N depends on the `MeasurementFormat` property.

MeasurementFormat Property	N
'Position'	1, 2, and 3
'Velocity'	1, 2, and 3
'PositionAndVelocity'	2, 4, and 6
'Custom'	Any

Data Types: char | string | function_handle

MeasurementFormat — Format of the fused measurement

'Position' (default) | 'Velocity' | 'PositionAndVelocity' | 'Custom'

Format of the fused measurement, specified as 'Position', 'Velocity', 'PositionAndVelocity', or 'Custom'. The formats are

- 'Position' - the fused measurement is the position of the target in the global coordinate frame.
- 'Velocity' - the fused measurement is the velocity of the target in the global coordinate frame.
- 'PositionAndVelocity' - the fused measurement is the position and velocity of the target in the global coordinate frame defined according to the format $[x; vx; y; vy; z; vz]$.
- 'Custom' - custom fused measurement. To enable this format, specify a function using the `MeasurementFcn`.

Example: 'PositionAndVelocity'

MeasurementFcn — Custom measurement function

char | string | function handle

Custom measurement function, specified as a character vector, string, or function handle. Specify the function that transforms fused measurements into sensor measurements. The function must have the following signature:

```
sensorMeas = MeasurementFcn(fusedMeas, measParameters)
```

Dependencies

To enable this property, set the `MeasurementFormat` property to 'Custom'.

Data Types: `char` | `string` | `function_handle`

MaxNumSensors — Maximum number of sensors in surveillance region

3 (default) | positive integer greater than one

Maximum number of sensors in surveillance region, specified as a positive integer greater than one.

Data Types: `double`

Volume — Volume of sensor detection bin

1e-2 (default) | positive scalar | *N*-length vector of positive scalars

Volume of sensors detection bins, specified as a positive scalar or *N*-length vector of positive scalars. *N* is the number of sensors. If specified as a scalar, each sensor is assigned the same volume. If a sensor produces an angle-only measurement, for example, azimuth and elevation, the volume is defined as the solid angle subtended by one bin.

Data Types: `double`

DetectionProbability — Probabilities of a target detection

0.9 (default) | positive scalar | *N*-length vector of positive scalars

Probability of detection of a target by each sensor, specified as a scalar or *N*-length vector of positive scalars in the range (0,1). *N* is the number of sensors. If specified as a scalar, each sensor is assigned the same detection probability. The probability of detection is used in calculating the cost of fusing a "one" (target was detected) or "zero" (target was not detected) detections from each sensor.

Example: 0.99

Data Types: `double`

FalseAlarmRate — Rate of false positives generated by sensors

1e-6 (default) | positive scalar | *N*-length vector of positive scalars

Rate at which false positives are reported by sensor in each bin, specified as a scalar or *N*-length vector of positive scalars. *N* is the number of sensors. If specified as a scalar, each sensor is assigned the same false alarm rate. The false alarm rate is used to calculate the likelihood of clutter in the detections reported by each sensor.

Example: 1e-5

Data Types: `double`

UseParallel — Option to use parallel computing resources

false (default) | true

Option to use parallel computing resources, specified as `false` or `true`. The `staticDetectionFuser` calculates the cost of fusing detections from each sensor as an *n*-D assignment problem. The fuser spends most of the time in computing the cost matrix for the assignment problem. If Parallel Computing Toolbox is installed, this option lets the fuser use the parallel pool of workers to compute the cost matrix.

Data Types: `logical`

TimeTolerance — Absolute tolerance between timestamps of detections

1e-6 (default) | nonnegative scalar

Absolute tolerance between timestamps of detections, specified as a nonnegative scalar. The `staticDetectionFuser` assumes that sensors are synchronous. This property defines the allowed tolerance value between detection time-stamps to still be considered synchronous.

Example: 1e-3

Data Types: double

Usage**Syntax**

```
compositeDets = fuser(dets)
[compositeDets,analysisInfo] = fuser(dets)
```

Description

`compositeDets = fuser(dets)` returns the fused detections, `compositeDets`, of input detections, `dets`.

`[compositeDets,analysisInfo] = fuser(dets)` also returns analysis information, `analysisInfo`.

Input Arguments**dets — Pre-fused detections**cell array of `objectDetection` objects

Pre-fused detections, specified as a cell array of `objectDetection` objects.

Output Arguments**compositeDets — Fused detections**cell array of `objectDetection` objects

Pre-fused detections, returned as a cell array of `objectDetection` objects.

analysisInfo — Analysis information

structure

Analysis information, returned as a structure. The fields of the structure are:

- `CostMatrix` - N -dimensional cost matrix providing the cost of association of detections, where N is the number of sensors. The cost is the negative log-likelihood of the association and can be interpreted as the negative score of the track that will be generated by the fused measurement.
- `Assignments` - A P -by- N list of assignments, where P is the number of composite detections.
- `FalseAlarms` - A Q -by-1 list of indices of detections declared as false alarms by association.

Data Types: struct

Object Functions

To use an object function, specify the System object as the first input argument. For example, to release system resources of a System object named `obj`, use this syntax:

```
release(obj)
```

Common to All System Objects

<code>release</code>	Release resources and allow changes to System object property values and input characteristics
<code>reset</code>	Reset internal states of System object
<code>isLocked</code>	Determine if System object is in use
<code>clone</code>	Create duplicate System object

Examples

Fuse Detections from ESM Sensors

Fuse angle-only detections from three ESM sensors.

Load stored detections from the sensors.

```
load('angleOnlyDetectionFusion.mat','detections');
```

Visualize angle-only detections for plotting the direction vector.

```
rPlot = 5000;
plotData = zeros(3,numel(detections)*3);
for i = 1:numel(detections)
    az = detections{i}.Measurement(1);
    el = detections{i}.Measurement(2);
    [xt,yt,zt] = sph2cart(deg2rad(az),deg2rad(el),rPlot);
    % The sensor is co-located at platform center, therefore use
    % the position from the second measurement parameter
    originPos = detections{i}.MeasurementParameters(2).OriginPosition;
    positionData(:,i) = originPos(:);
    plotData(:,3*i-2) = [xt;yt;zt] + originPos(:);
    plotData(:,3*i-1) = originPos(:);
    plotData(:,3*i) = [NaN;NaN;NaN];
end
plot3(plotData(1,:),plotData(2,:),plotData(3,),'r-')
hold on
plot3(positionData(1,:),positionData(2,:),positionData(3,),'o','MarkerSize',12,'MarkerFaceColor'
```

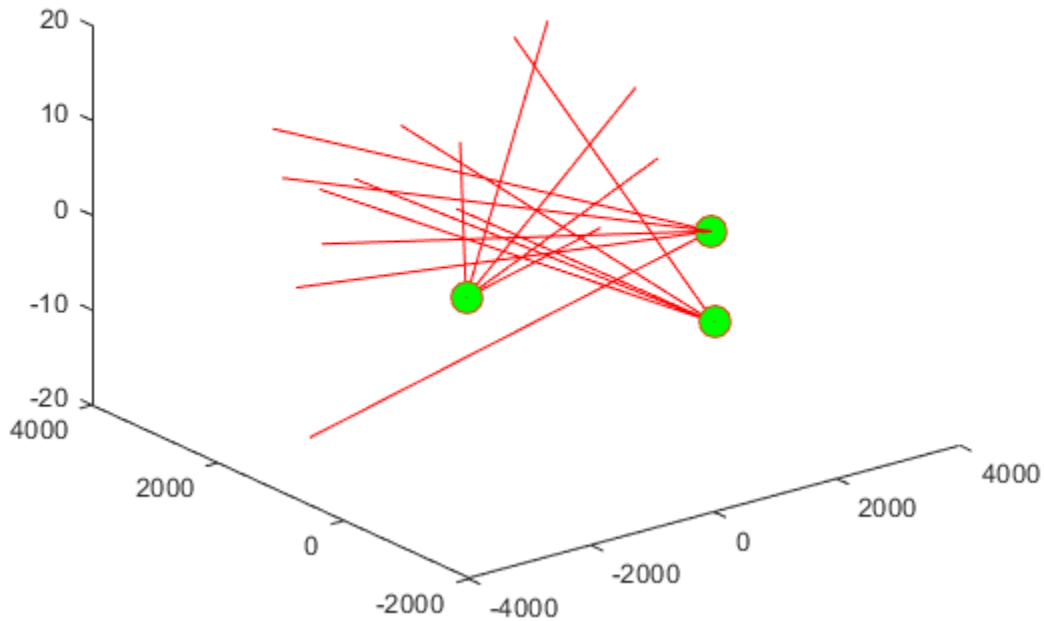

Create a `staticDetectionFuser` to fuse angle-only detections using the measurement fusion function `triangulateLOS`.

```
fuser = staticDetectionFuser('MeasurementFusionFcn','triangulateLOS','MaxNumSensors',3)
```

```
fuser =
  staticDetectionFuser with properties:
    FusedSensorIndex: 1
    MeasurementFusionFcn: 'triangulateLOS'
    MeasurementFormat: 'Position'
    MaxNumSensors: 3
    Volume: [3x1 double]
    DetectionProbability: [3x1 double]
    FalseAlarmRate: [3x1 double]
    TimeTolerance: 1.0000e-06
    UseParallel: false
```

Create the fused detections and obtain the analysis information.

```
[fusedDetections, analysisInfo] = fuser(detections);
fusedPositions = zeros(3,numel(fusedDetections));
for i = 1:numel(fusedDetections)
    fusedPositions(:,i) = fusedDetections{i}.Measurement;
end
```

```

plot3(fusedPositions(1,:),fusedPositions(2,:),fusedPositions(3,:),'ko', ...
      'MarkerSize',12, 'MarkerFaceColor','k')
legend('Angle-only Detections','Sensor Positions','Fused Target Measurements')
title('Angle-only Detection Fusion')
xlabel('x [m]')
ylabel('y [m]')
view(2)

```

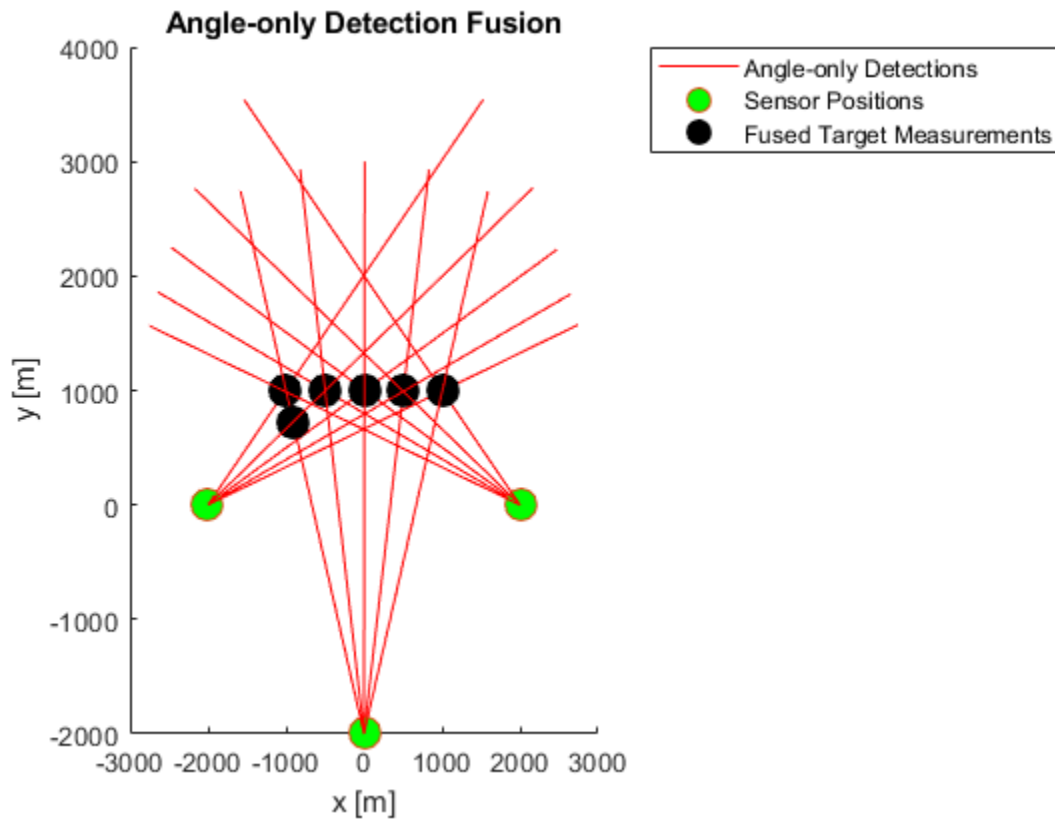

Use the analysisInfo output to check the assignments.

```
analysisInfo.Assignments
```

```
ans = 6x3 uint32 matrix
```

```

0  10  14
1   6  11
2   7  12
3   8  13
4   9   0
5   0  15

```

Algorithms

Detection Fusion Workflow

The static detection fuser:

- Calculates the cost of fusing or matching detections from each sensor to one another.
- Solves a 2-D or S-D assignment problem, where S is the number of sensors, to associate or match detections from one sensor to others.
- Fuses the measurement and measurement covariance of the associated detection n-tuples to generate a list of composite or fused detections.
- Declares unassigned detections from each sensor as false alarms.

The `staticDetectionFuser` assumes that all sensors are synchronous and generate detections simultaneously. The `staticDetectionFuser` also assumes that the sensors share a common surveillance region. Associating n detections from m sensors indicates $m - n$ missed detections or false alarms.

References

- [1] Bar-Shalom, Yaakov, Peter K. Willett, and Xin Tian. *Tracking and data fusion*. Storrs, CT, USA:: YBS publishing, 2011.

Extended Capabilities

C/C++ Code Generation

Generate C and C++ code using MATLAB® Coder™.

Usage notes and limitations:

See “System Objects in MATLAB Code Generation” (MATLAB Coder).

See Also

Functions

`triangulateLOS`

Objects

`fusionRadarSensor` | `irSensor` | `objectDetection` | `sonarSensor`

Introduced in R2018b

timescope

Display time-domain signals

Description

The timescope object displays signals in the time domain.

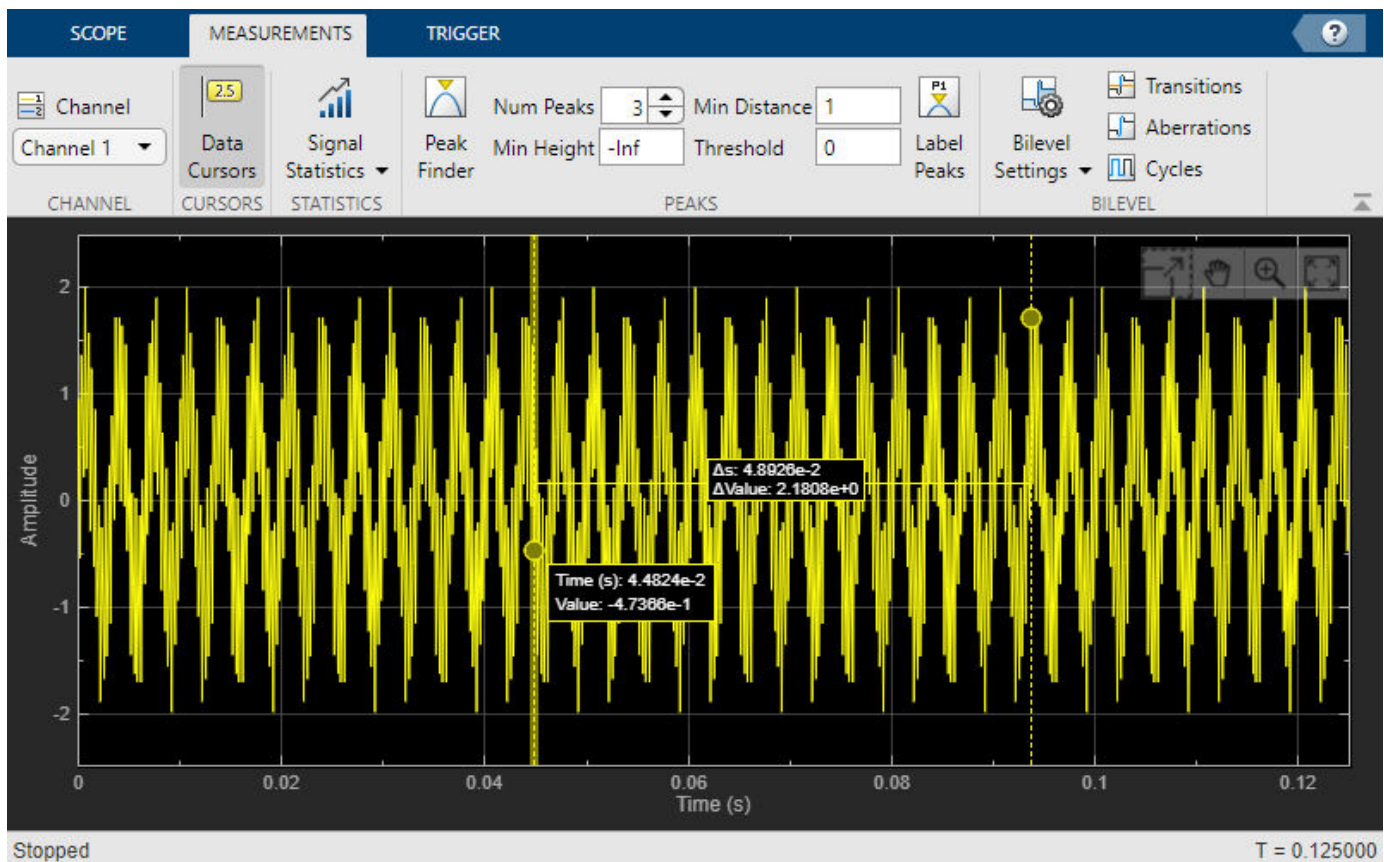

Scope features:

- “Data Cursors” — Measure signal values using vertical and horizontal cursors.
- “Signal Statistics” — Display the maximum, minimum, peak-to-peak difference, mean, median, and RMS values of a selected signal.
- “Peak Finder” — Find maxima, showing the x-axis values at which they occur.
- “Bilevel Measurements” — Measure transitions, overshoots, undershoots, and cycles.
- “Triggers” — Set triggers to sync repeating signals and pause the display when events occur.

Use “Object Functions” on page 3-637 to show, hide, and determine visibility of the scope window.

Creation

Syntax

```
scope = timescope
scope = timescope(Name,Value)
```

Description

`scope = timescope` returns a `timescope` object, `scope`. This object displays real- and complex-valued floating and fixed-point signals in the time domain.

`scope = timescope(Name,Value)` returns a `timescope` object with properties set to the specified value. Specify properties and their values in quotes, separated by commas. You can specify name-value pair arguments in any order.

Properties

Most properties can be changed from the `timescope` UI.

Frequently Used

SampleRate — Sample rate of inputs

1 (default) | finite numeric scalar | vector

Sampling rate of the input signal, in hertz, specified as a finite numeric scalar or vector of scalars.

The inverse of the sample rate determines the x-axis (time axis) spacing between points in the displayed signal. When the value of `NumInputPorts` is greater than 1 and the sample rate is scalar, the object uses the same sample rate for all inputs. To specify different sample rates for each input, use a vector.

You can only set this property when creating the object or after calling `release`.

UI Use

On the **Scope** tab, click **Settings**. Under **Data and Axes**, set **Sample Rate**.

Data Types: `single` | `double` | `int8` | `int16` | `int32` | `int64` | `uint8` | `uint16` | `uint32` | `uint64`

TimeSpanSource — Source of time span

'auto' (default) | 'property'

Source of the time span for frame-based input signals, specified as one of the following:

- 'property' - The object derives the x-axis limits from the `TimeDisplayOffset` and `TimeSpan` properties.
- 'auto' - The x-axis limits are derived from the `TimeDisplayOffset` property, `SampleRate` property, and the number of rows in each input signal (`FrameSize` in the equations below). The limits are calculated as:
 - Minimum time-axis limit = `TimeDisplayOffset`
 - Maximum time-axis limit = `TimeDisplayOffset + max(1/SampleRate.*FrameSize)`

UI Use

On the **Scope** tab, click **Settings**. Under **Data and Axes**, set **Time Span**.

Data Types: char | string

TimeSpan — Time span

10 (default) | positive scalar

Time span, in seconds, specified as a positive, numeric scalar value. The time-axis limits are calculated as:

- Minimum time-axis limit = TimeDisplayOffset
- Maximum time-axis limit = TimeDisplayOffset + TimeSpan

Dependencies

To enable this property, set TimeSpanSource to 'property'.

UI Use

On the **Scope** tab, click **Settings**. Under **Data and Axes**, edit **Time Span**.

Data Types: single | double | int8 | int16 | int32 | int64 | uint8 | uint16 | uint32 | uint64

TimeSpanOverrunAction — Data overrun behavior

'scroll' (default) | 'wrap'

Specify how the scope displays new data beyond the visible time span as either:

- 'scroll' — In this mode, the scope scrolls old data to the left to make room for new data on the right of the scope display. This mode is beneficial for debugging and monitoring time-varying signals.
- 'wrap' — In this mode, the scope adds data to the left of the plot after overrunning the right of the plot.

UI Use

On the **Scope** tab, click **Settings**. Under **Data and Axes**, set **Overrun Action**.

Data Types: char | string

PlotType — Type of plot

'line' (default) | 'stairs'

Type of plot, specified as either:

- 'line' — Line graph, similar to the line or plot function.
- 'stairs' — Stair-step graph, similar to the stairs function. Stair-step graphs are useful for drawing time history graphs of digitally sampled data.

UI Use

On the **Scope** tab, click **Settings**. Under **Data and Axes**, set **Plot Type**.

Data Types: char | string

AxesScaling — Axes scaling mode`'onceatstop' (default) | 'auto' | 'manual' | 'updates'`

When this property is set to:

- `'onceatstop'` -- The limits are updated once at the end of the simulation (when `release` is called).
- `'auto'` -- The scope attempts to always keep the data in the display while minimizing the number of updates to the axes limits.
- `'manual'` -- The scope takes no action unless specified by the user.
- `'updates'` -- The scope scales the axes once and only once after 100 updates to the visualization.

You can set this property only when creating the object.

Data Types: `char` | `string`

Advanced**LayoutDimensions — Display layout grid dimensions**`[1,1] (default) | [numberOfRows, numberOfColumns]`

Specify the layout grid dimensions as a two-element vector: `[numberOfRows, numberOfColumns]`. The grid can have a maximum of 4 rows and 4 columns.

If you create a grid of multiple axes, to modify the settings of individual axes, use the `ActiveDisplay`.

Example: `scope.LayoutDimensions = [2,4]`

UI Use

On the **Scope** tab, click **Display Grid** () and select a specific number of rows and columns from the grid.

Data Types: `single` | `double` | `int8` | `int16` | `int32` | `int64` | `uint8` | `uint16` | `uint32` | `uint64`

TimeUnits — Units of x-axis`'seconds' (default) | 'none' | 'metric'`

Specify the units used to describe the x-axis (time axis). You can select one of the following options:

- `'seconds'` —The scope always displays the units on the x-axis as seconds. The scope shows the word `Time(s)` on the x-axis.
- `'none'` — The scope does not display any units on the x-axis. The scope only shows the word `Time` on the x-axis.
- `'metric'` — The scope displays the units on the x-axis as `Time (s)` changing the units to day, weeks, months, or years as you plot more data points.

UI Use

On the **Scope** tab, click **Settings**. Under **Data and Axes**, set **Time Units**.

Data Types: `char` | `string`

TimeDisplayOffset — Offset x-axis limits

0 (default) | scalar | vector

Specify, in seconds, how far to move the data on the x-axis. The signal value does not change, only the limits displayed on the x-axis change.

If you specify this property as a scalar, then that value is the time display offset for all channels. If you specify this property as a vector, each input channel can be a different time display offset

UI Use

On the **Scope** tab, click **Settings**. Under **Data and Axes**, set **Time Offset**.

TimeAxisLabels — Time-axis labels

'all' (default) | 'bottom' | 'none'

Time-axis labels, specified as:

- 'all' — Time-axis labels appear in all displays.
- 'bottom' — Time-axis labels appear in the bottom display of each column.
- 'none' — No labels appear in any display.

UI Use

On the **Scope** tab, click **Settings**. Under **Data and Axes**, set **Time Labels**.

Data Types: char | string

MaximizeAxes — Maximize axes control

'auto' (default) | 'on' | 'off'

Specify whether to display the scope in the maximized-axes mode. In this mode, the axes are expanded to fit into the entire display. To conserve space, labels do not appear in each display. Instead, the tick-marks and their values appear on top of the plotted data. You can select one of the following options:

- 'auto' — The axes appear maximized in all displays only if the **Title** and **YLabel** properties are empty for every display. If you enter any value in any display for either of these properties, the axes are not maximized.
- 'on' — The axes appear maximized in all displays. Any values entered into the **Title** and **YLabel** properties are hidden.
- 'off' — None of the axes appear maximized.

UI Use

On the scope window, click on  to maximize axes, hiding all labels and inseting the axes values.

Data Types: char | string

BufferLength — Buffer length

50000 (default) | positive integer

Specify the length of the buffer used for each input signal as a positive integer.

You can set this property only when creating the object.

UI Use

On the **Scope** tab, click **Settings**. Under **Data and Axes**, set **Buffer Length**.

Data Types: `single` | `double` | `int8` | `int16` | `int32` | `int64` | `uint8` | `uint16` | `uint32` | `uint64`

Visualization**Name — Window name**

'Time Scope' (default) | character vector | string scalar

Specify the name of the scope as a character vector or string scalar. This name appears as the title of the scope's figure window. To specify a title of a scope plot, use the `Title` property.

Data Types: `char` | `string`

Position — Window position

screen center (default) | [`left bottom width height`]

Scope window position in pixels, specified by the size and location of the scope window as a four-element vector of the form [`left bottom width height`]. You can place the scope window in a specific position on your screen by modifying the values of this property.

By default, the window appears in the center of your screen with a width of 800 pixels and height of 500 pixels. The exact values of the position depend on your screen resolution.

ChannelNames — Channel names

{ ' ' } (default) | cell array of character vectors

Specify the input channel names as a cell array of character vectors. The channel names appear in the legend, and on the **Measurements** tab under **Select Channel**. If you do not specify names, the channels are labeled as `Channel 1`, `Channel 2`, etc.

Dependency

To enable this property, set `ShowLegend` to `true`.

Data Types: `char`

ActiveDisplay — Active display for setting properties

1 (default) | integer

Active display used to set properties, specified by the integer display number. The number of a display corresponds to the display's row-wise placement index. Setting this property controls which display is used for the following properties: `YLimits`, `YLabel`, `ShowLegend`, `ShowGrid`, `Title`, and `PlotAsMagnitudePhase`.

UI Use

On the **Scope** tab, click **Settings**. Under **Display and Labels**, set **Active Display**.

Title — Display title

' ' (default) | character vector | string scalar

Specify the display title as a character vector or a string scalar.

Dependency

When you set this property, `ActiveDisplay` controls the display that is updated.

UI Use

On the **Scope** tab, click **Settings**. Under **Display and Labels**, set **Title**.

Data Types: `char` | `string`

YLabel — y-axis label

'Amplitude' (default) | character vector | string scalar

Specify the text for the scope to display to the left of the y-axis.

Dependencies

This property applies only when `PlotAsMagnitudePhase` is `false`. When `PlotAsMagnitudePhase` is `true`, the two y-axis labels are read-only values "Magnitude" and "Phase", for the magnitude plot and the phase plot, respectively.

When you set this property, `ActiveDisplay` controls the display that is updated.

UI Use

On the **Scope** tab, click **Settings**. Under **Display and Labels**, set **YLabel**.

Data Types: `char` | `string`

YLimits — y-axis limits

[-10,10] (default) | [ymin, ymax]

Specify the y-axis limits as a two-element numeric vector, [ymin, ymax].

- If `PlotAsMagnitudePhase` is `false`, the default is [-10, 10].
- If `PlotAsMagnitudePhase` is `true`, the default is [0, 10]. This property specifies the y-axis limits of only the magnitude plot. The y-axis limits of the phase plot are always [-180, 180]

Dependency

When you set this property, `ActiveDisplay` controls the display that is updated.

UI Use

On the **Scope** tab, click **Settings**. Under **Display and Labels**, set **Y-Axis Limits**.

ShowLegend — Show legend

false (default) | true

To show a legend with the input names, set this property to `true`.

From the legend, you can control which signals are visible. In the scope legend, click a signal name to hide the signal in the scope. To show the signal, click the signal name again.

UI Use

On the **Scope** tab, click **Settings**. Under **Display and Labels**, select **Show Legend**.

Data Types: `logical`

ShowGrid — Grid visibility`true (default) | false`

Set this property to `true` to show grid lines on the plot.

UI Use

On the **Scope** tab, click **Settings**. Under **Display and Labels**, select **Show Grid**.

PlotAsMagnitudePhase — Plot signal as magnitude and phase`false (default) | true`

Plot signal as magnitude and phased, specified as either:

- `true` - The scope plots the magnitude and phase of the input signal on two separate axes within the same active display.
- `false` - The scope plots the real and imaginary parts of the input signal on two separate axes within the same active display.

This property is useful for complex-valued input signals. Turning on this property affects the phase for real-valued input signals. When the amplitude of the input signal is nonnegative, the phase is 0 degrees. When the amplitude of the input signal is negative, the phase is 180 degrees.

UI Use

On the **Scope** tab, click **Settings**. Under **Display and Labels**, select **Magnitude Phase Plot**.

Object Functions

To use an object function, specify the object as the first input argument.

<code>hide</code>	Hide scope window
<code>show</code>	Display scope window
<code>isVisible</code>	Determine visibility of scope
<code>generateScript</code>	Generate MATLAB script to create scope with current settings
<code>step</code>	Run System object algorithm
<code>release</code>	Release resources and allow changes to System object property values and input characteristics
<code>reset</code>	Reset internal states of System object

Examples**View Sine Wave on Time Scope**

Create a time-domain sinusoidal signal. Display the signal by calling the time scope object.

Create a sinusoidal signal with two tones, one at 0.3 kHz and the other at 3 kHz.

```
t = (0:1000)'/8e3;
xin = sin(2*pi*0.3e3*t)+sin(2*pi*3e3*t);
```

Create a `timescope` object and view the sinusoidal signal by calling the time scope object `scope`.

```
scope = timescope('SampleRate', 8e3, ...
    'TimeSpanSource', 'property', ...
```

```
'TimeSpan', 0.1);  
scope(xin)
```

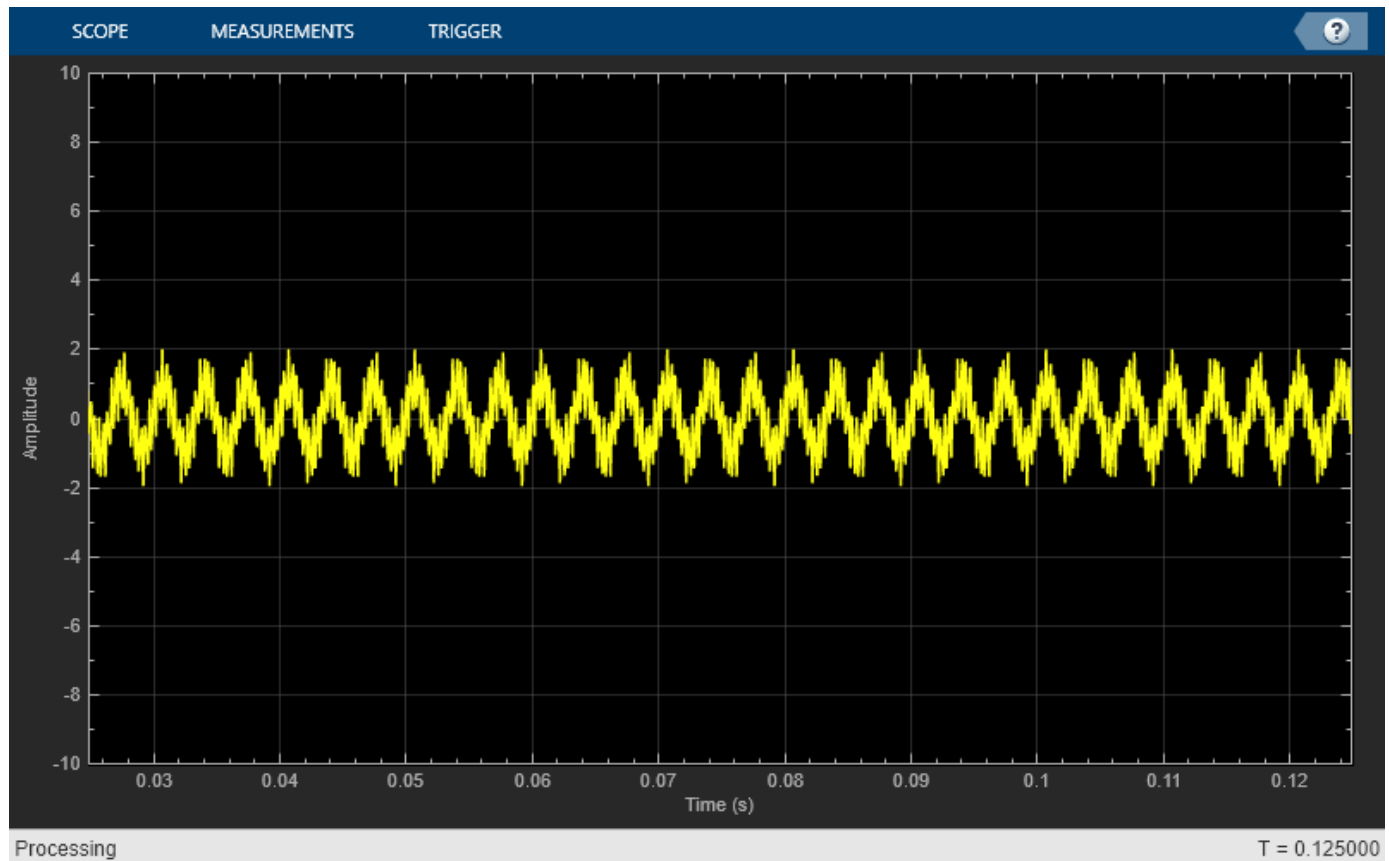

Run `release` to allow changes to property values and input characteristics. The scope automatically scales the axes.

```
release(scope);
```

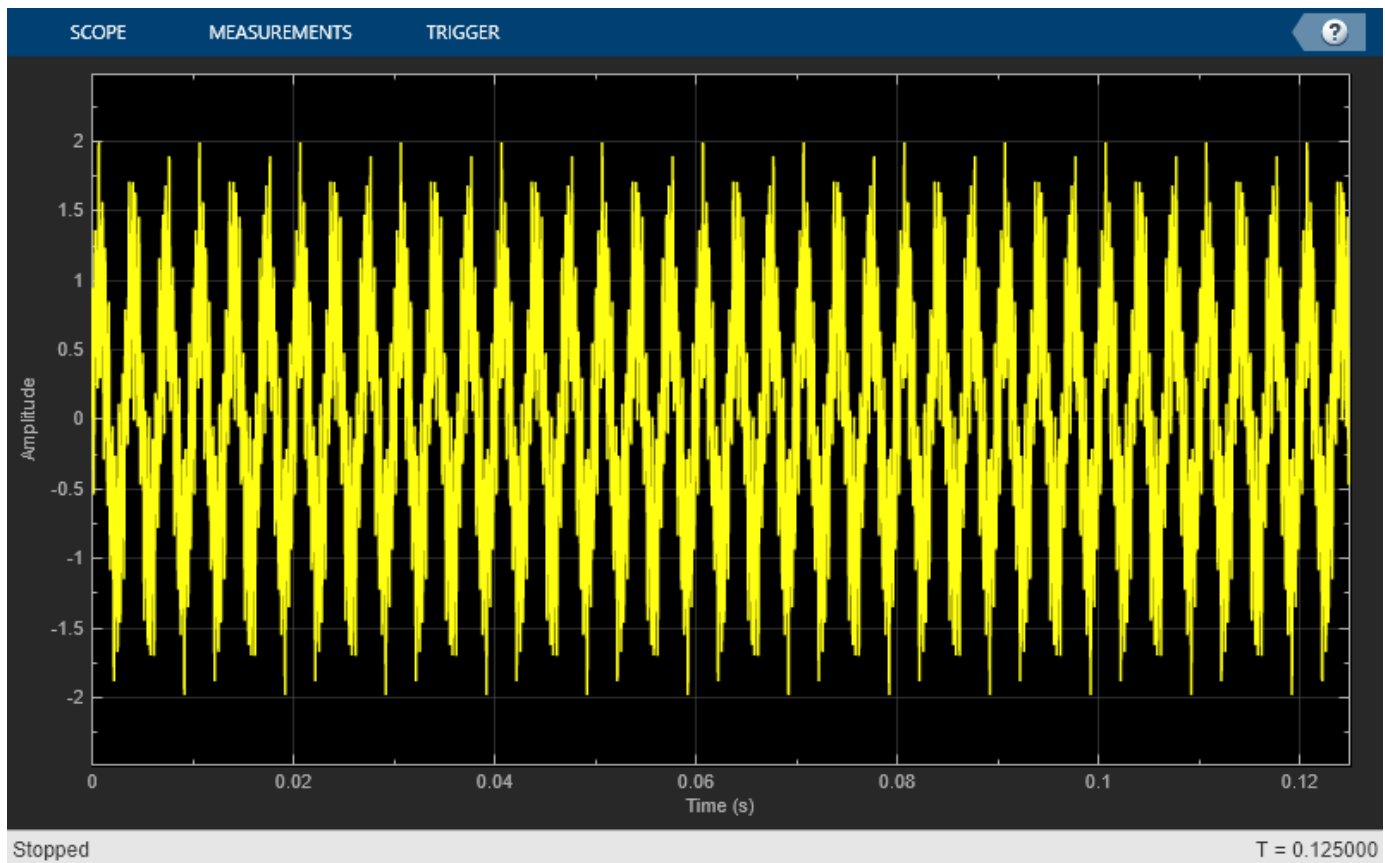



Hide the scope window.

```
if(isVisible(scope))  
    hide(scope)  
end
```

Show the scope window.

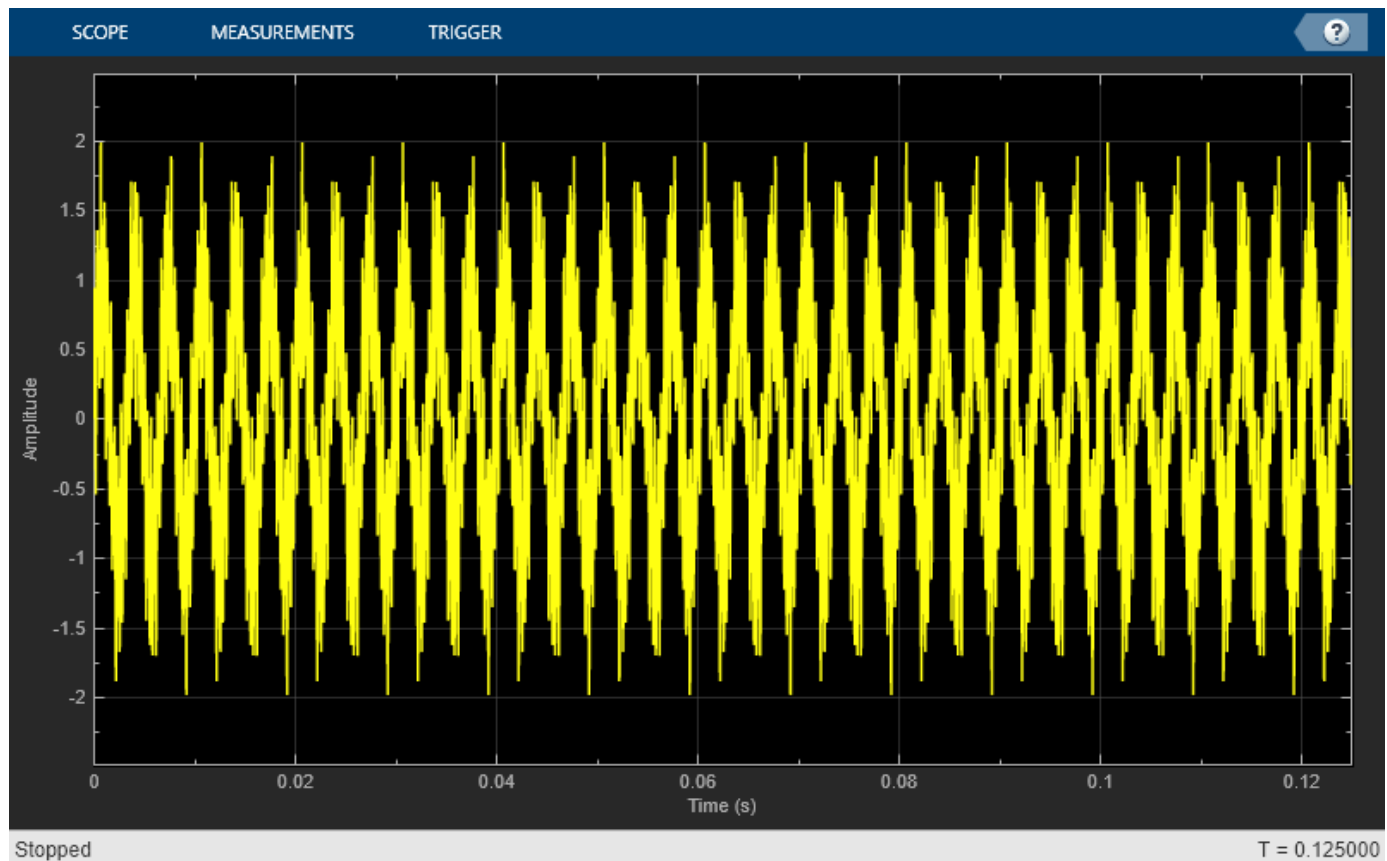
```
if(~isVisible(scope))  
    show(scope)  
end
```



Use Bilevel Measurements Panel with Clock Input Signal

Create and Display Clock Input Signal

Load the clock data, `x` and `t`. Find the sample time, `ts`.

```
load clockx
ts = t(2)-t(1);
```

Create a `timescope` object and call the object to display the signal. To autoscale the axes and enable changes to property values and input characteristics, call `release`.

```
scope = timescope(1,1/ts,'TimeSpanSource','Auto');
scope(x);
release(scope);
```

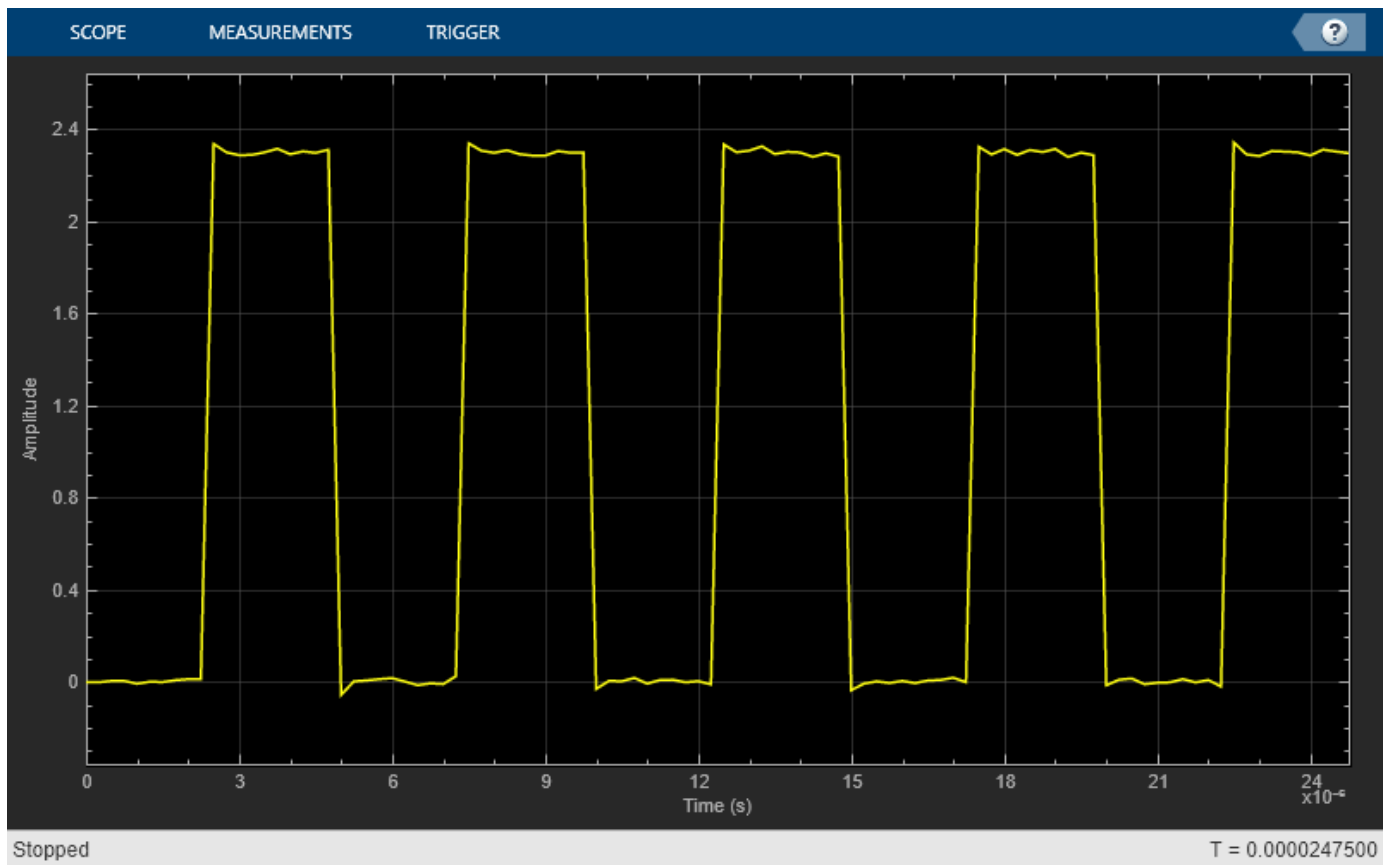

Use Bilevel Measurements Panel to Find Settling Time

1. From the **Measurements** tab, select **Aberrations**.

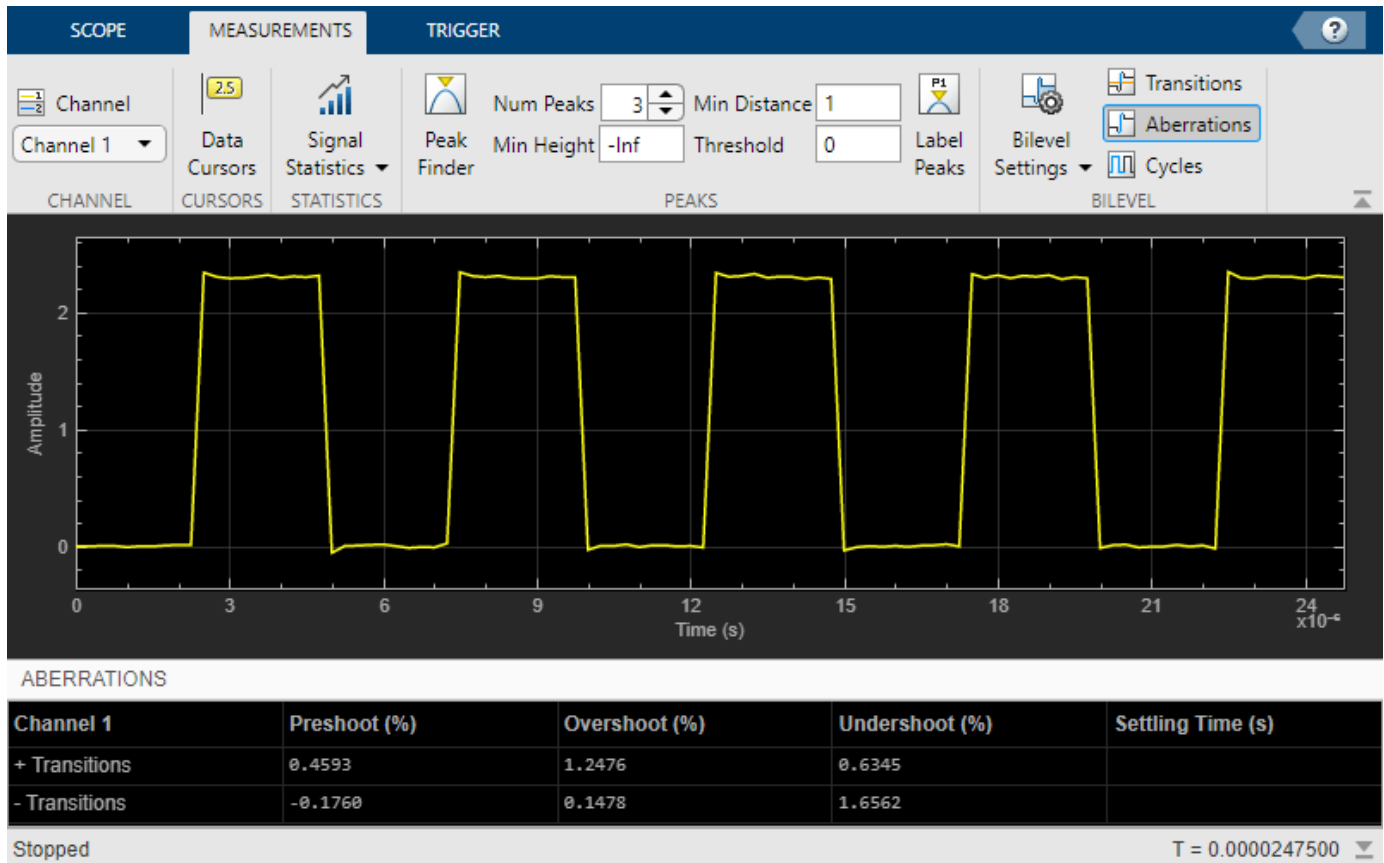

Initially, the Time Scope does not display the **Settling Time** measurement. This absence occurs because the default value of the **Settle Seek** parameter is longer than the entire simulation duration.

2. In the **Bilevel Settings > Settle Seek** box, enter $2e-6$ and press **Enter**.

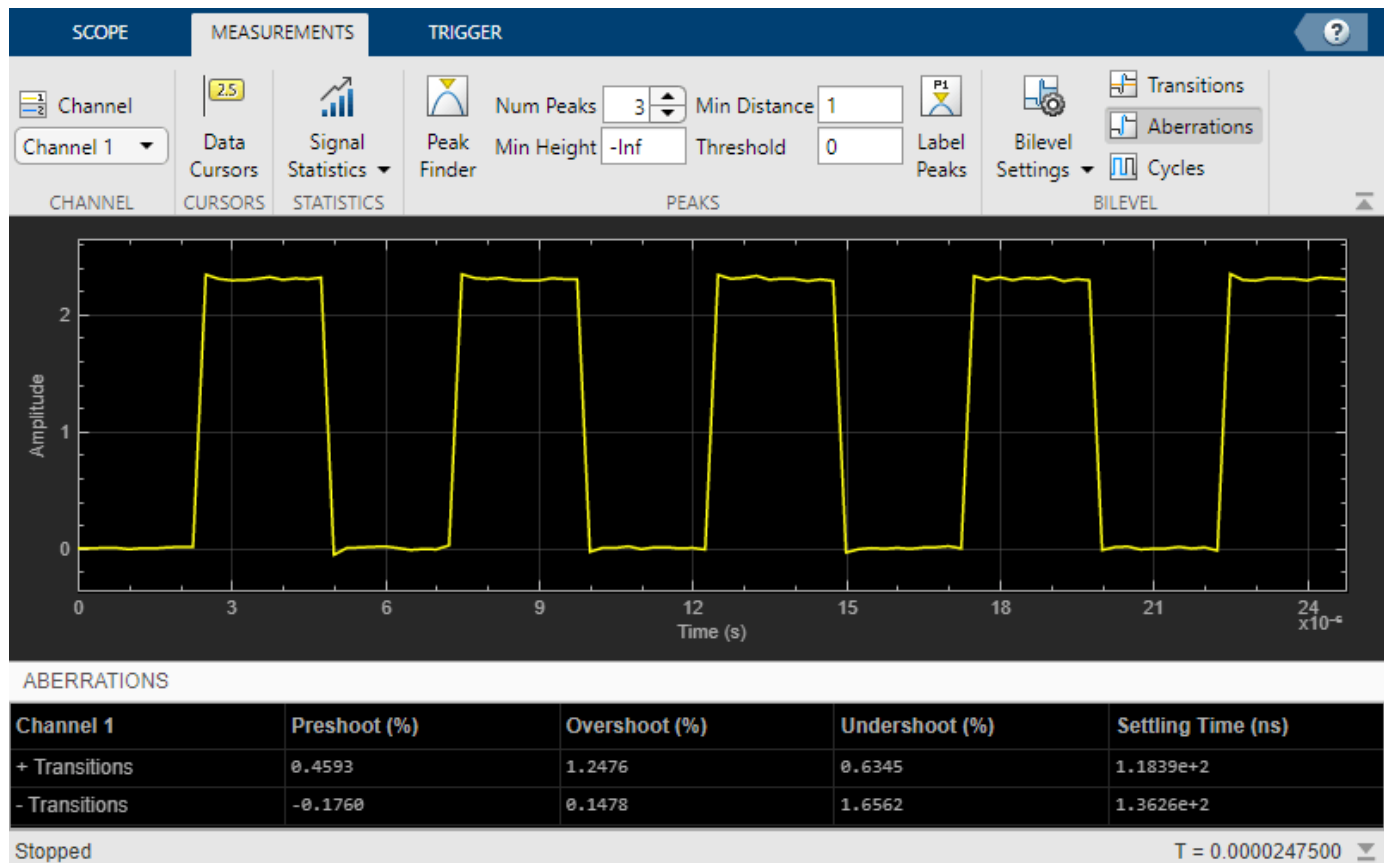

Time Scope now displays a rising edge **Settling Time** value of 118.392 ns.

This settling time value is actually the statistical average of the settling times for all five rising edges. To show the settling time for only one rising edge, you can zoom in on that transition.

3. Hover over the upper right corner of the scope axes, and click the zoom button.
4. Click and drag to zoom in on one of the transitions.

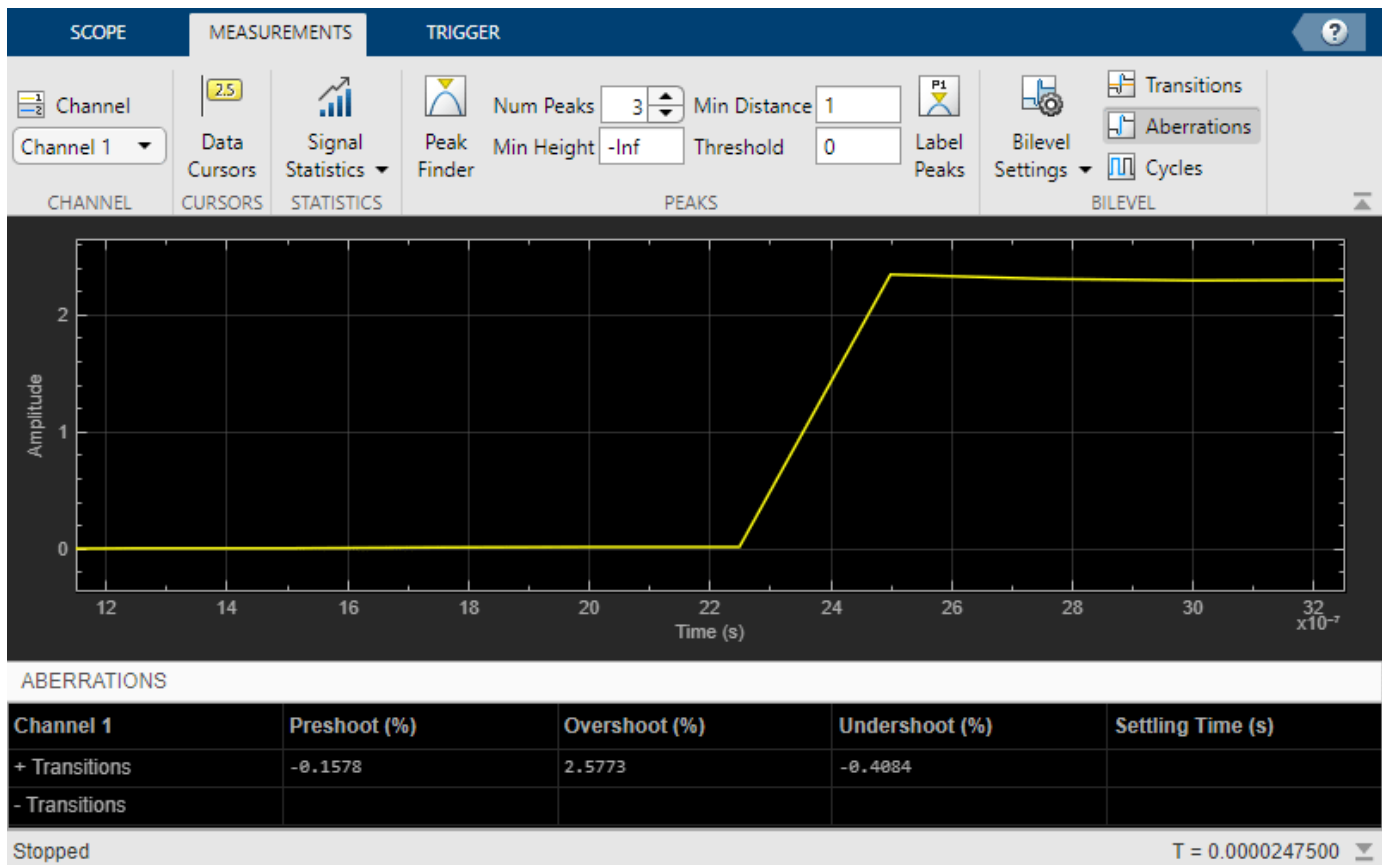

Time Scope updates the rising edge **Settling Time** value to reflect the new time window.

View Sine Wave Input Signals at Different Sample Rates and Offsets

Create a `dsp.SineWave` with a 1000 Hz sampling frequency. Create a `dsp.FIRDecimator` object to decimate the sine wave by 2. Create a `timescope` object with two input ports.

```
Fs = 1000; % Sampling frequency
sine = dsp.SineWave('Frequency',50,...
    'SampleRate',Fs, ...
    'SamplesPerFrame',100);
decimate = dsp.FIRDecimator; % To decimate sine by 2
scope = timescope(2,[Fs Fs/2], ...
    'TimeDisplayOffset',[0 38/Fs], ...
    'TimeSpanSource','Property',...
    'TimeSpan',0.25, ...
    'YLimits',[-1 1], ...
    'ShowLegend', true);
```

Call the `dsp.SineWave` object to create a sine wave signal. Use the `dsp.FIRDecimator` object to create a second signal that equals the original signal, but decimated by a factor of 2. Display the signals by calling the `timescope` object.

```
for ii = 1:2
    xsine = sine();
```

```

    xdec = decimate(xsine);
    scope(xsine,xdec)
end
release(scope)

```

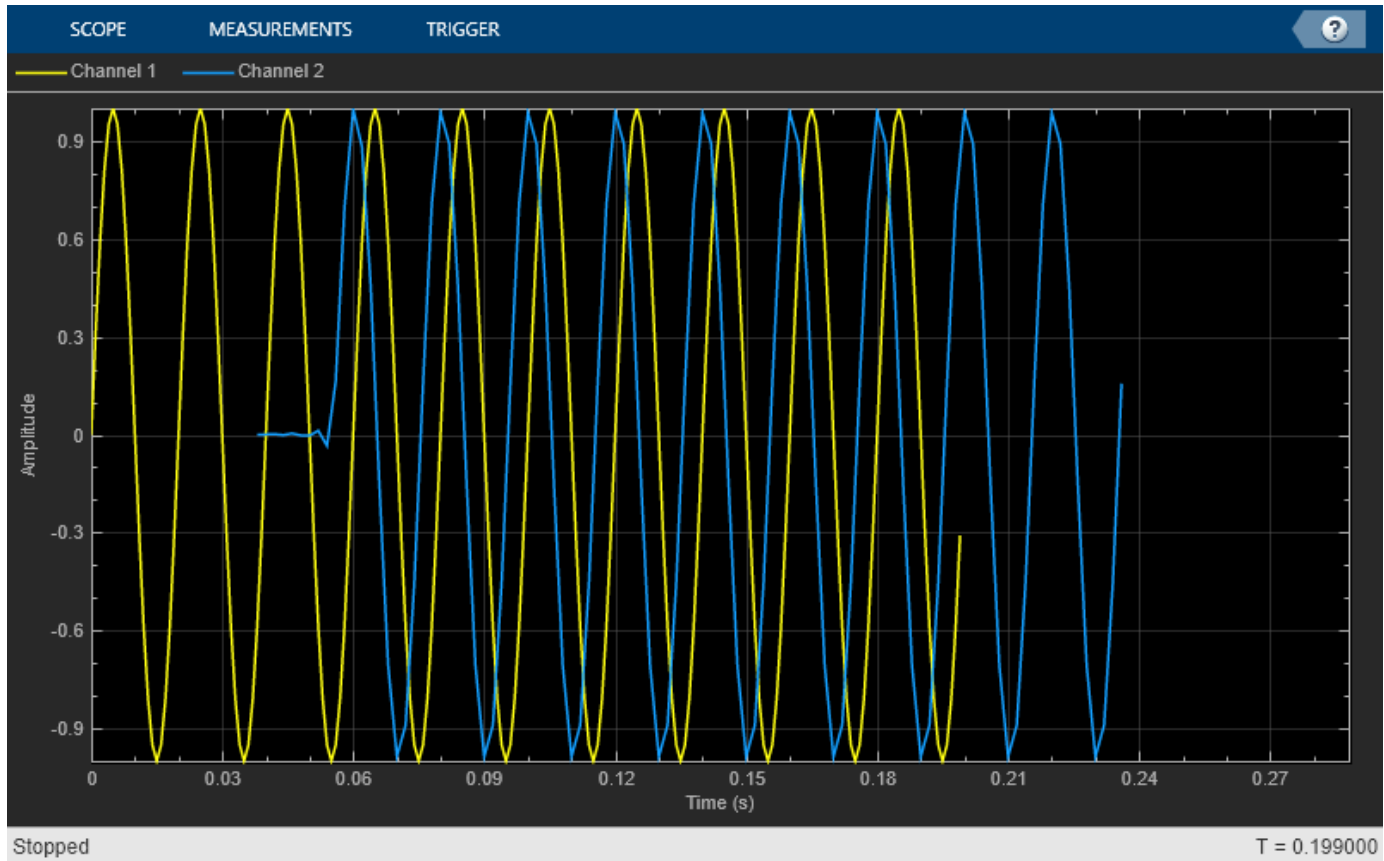

Close the Time Scope window and clear the variables.

```
clear scope Fs sine decimate ii xsine xdec
```

Display Complex-Valued Input Signal

Create a vector representing a complex-valued sinusoidal signal, and create a timescope object. Call the scope to display the signal.

```

fs = 1000;
t = (0:1/fs:10)';
CxSine = cos(2*pi*0.2*t) + 1i*sin(2*pi*0.2*t);
CxSineSum = cumsum(CxSine);
scope = timescope(1,fs,'TimeSpanSource','Auto','ShowLegend',1);
scope(CxSineSum);
release(scope)

```

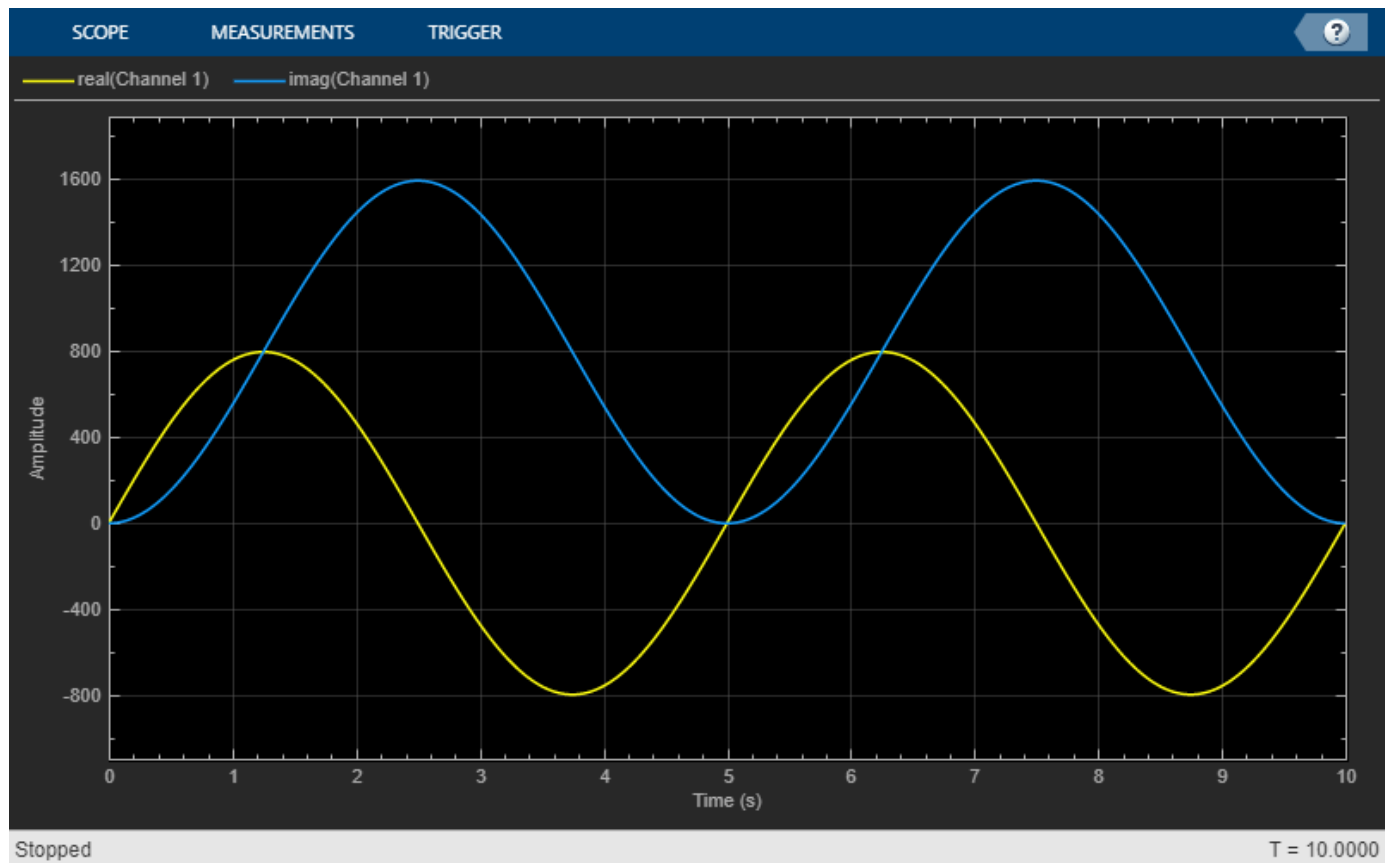

By default, when the input is a complex-valued signal, Time Scope plots the real and imaginary portions on the same axes. These real and imaginary portions appear as different-colored lines on the same axes within the same active display.

Change the `PlotAsMagnitudePhase` property to `true` and call `release`.

```
scope.PlotAsMagnitudePhase = true;  
scope(CxSineSum);  
release(scope)
```

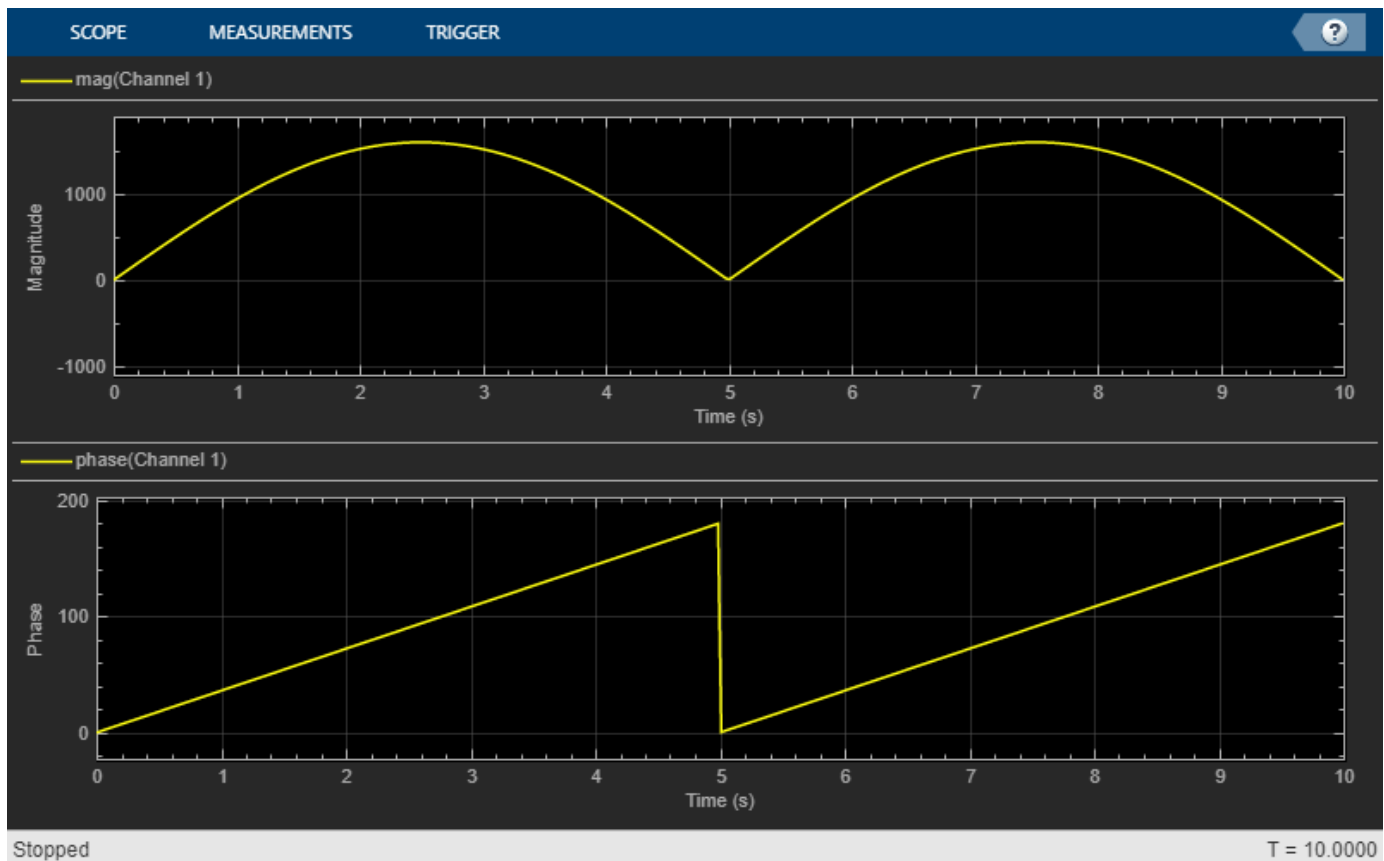
Time Scope now plots the magnitude and phase of the input signal on two separate axes within the same active display. The top axes display magnitude and the bottom axes display the phase, in degrees.

Display Input Signal of Changing Size

This example shows how the `timescope` object visualizes inputs that change dimensions halfway through.

Create a vector that represents a two-channel constant signal. Create another vector that represents a three-channel constant signal. Create a `timescope` object. Call the scope with two inputs to display the signal.

```
fs = 10;
sigdim2 = [ones(5*fs,1) 1+ones(5*fs,1)]; % 2-dim 0-5 s
sigdim3 = [2+ones(5*fs,1) 3+ones(5*fs,1) 4+ones(5*fs,1)]; % 3-dim 5-10 s
scope = timescope('SampleRate',fs,'TimeSpanSource','Property');
scope.PlotType = 'Stairs';
scope.TimeSpanOvverrunAction = 'Scroll';
scope.TimeDisplayOffset = [0 5];
scope([sigdim2; sigdim3(:,1:2)], sigdim3(:,3));
```

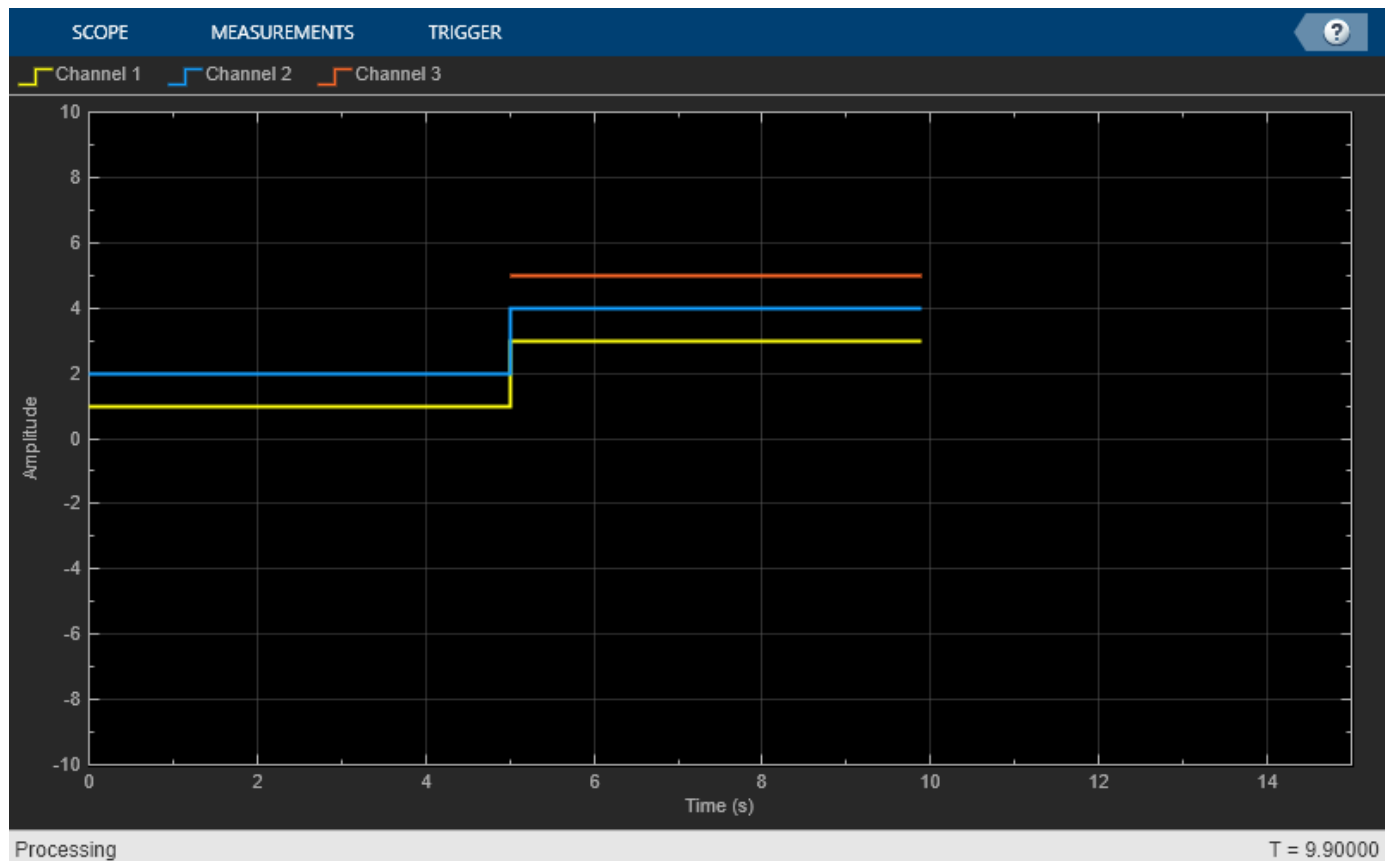

In this example, the size of the input signal to the Time Scope changes as the simulation progresses. When the simulation time is less than 5 seconds, Time Scope plots only the two-channel signal, `sigdim2`. After 5 seconds, Time Scope also plots the three-channel signal, `sigdim3`.

Run the `release` method to enable changes to property values and input characteristics. The scope automatically scales the axes.

```
release(scope)
```

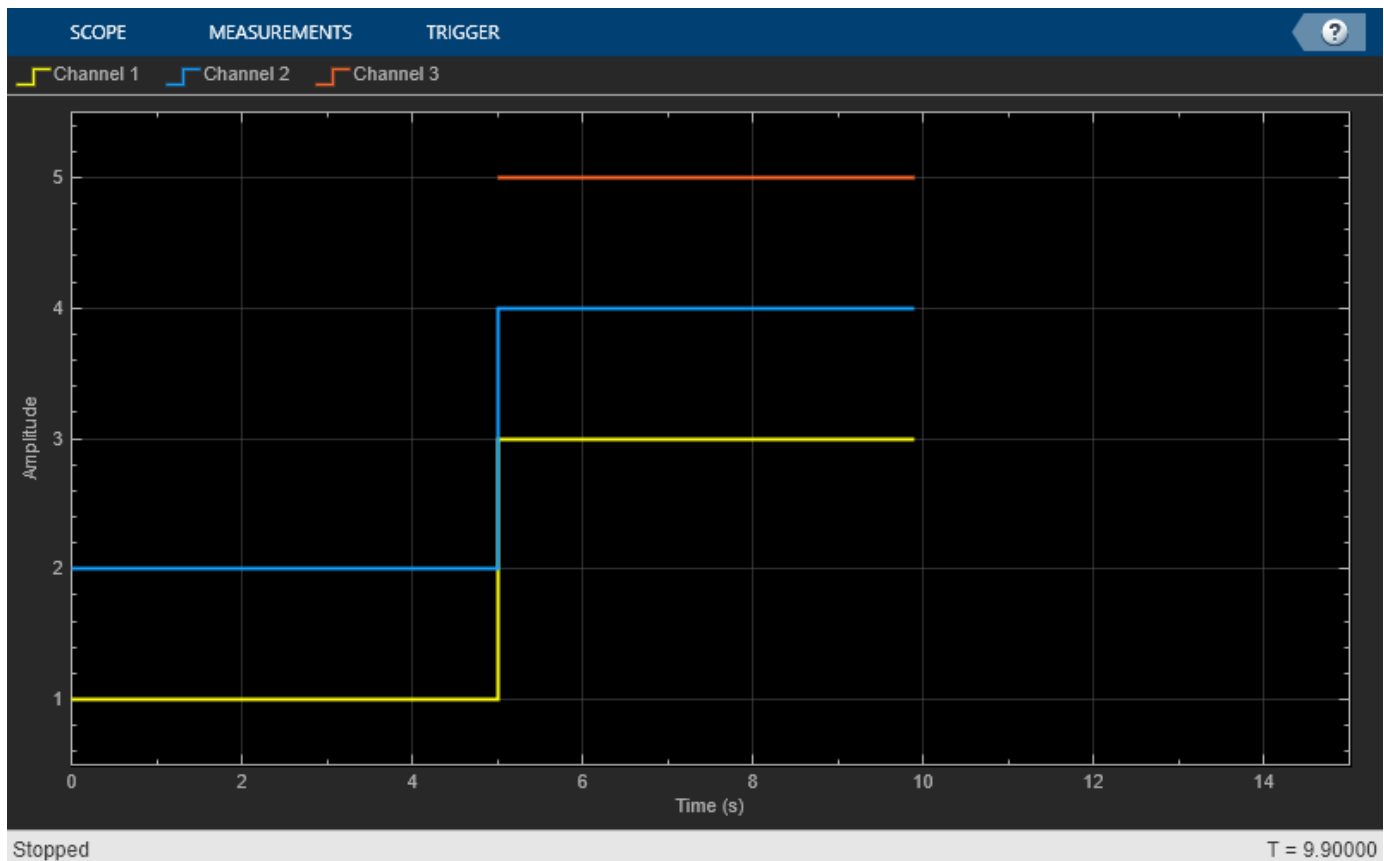

Find Heart Rate Using Peak Finder Panel with ECG Input Signal

Use Peak Finder panel of the Time Scope to measure a heart rate.

Create and Display ECG Signal

Create the electrocardiogram (ECG) signal. The custom `ecg` function helps generate the heartbeat signal.

```
function x = ecg(L)
a0 = [0, 1, 40, 1, 0, -34, 118, -99, 0, 2, 21, 2, 0, 0, 0];
d0 = [0, 27, 59, 91, 131, 141, 163, 185, 195, 275, 307, 339, 357, 390, 440];
a = a0 / max(a0);
d = round(d0 * L / d0(15));
d(15) = L;
for i = 1:14
    m = d(i) : d(i+1) - 1;
    slope = (a(i+1) - a(i)) / (d(i+1) - d(i));
    x(m+1) = a(i) + slope * (m - d(i));
end

x1 = 3.5*ecg(2700).';
y1 = sgolayfilt(kron(ones(1,13),x1),0,21);
```

```
n = (1:30000)';
del = round(2700*rand(1));
mhb = y1(n + del);
ts = 0.00025;
```

Create a `timescope` object and call the object to display the signal. To autoscale the axes and enable changes to property values and input characteristics, call `release`.

```
scope = timescope(1,1/ts);
scope(mhb);
release(scope)
```

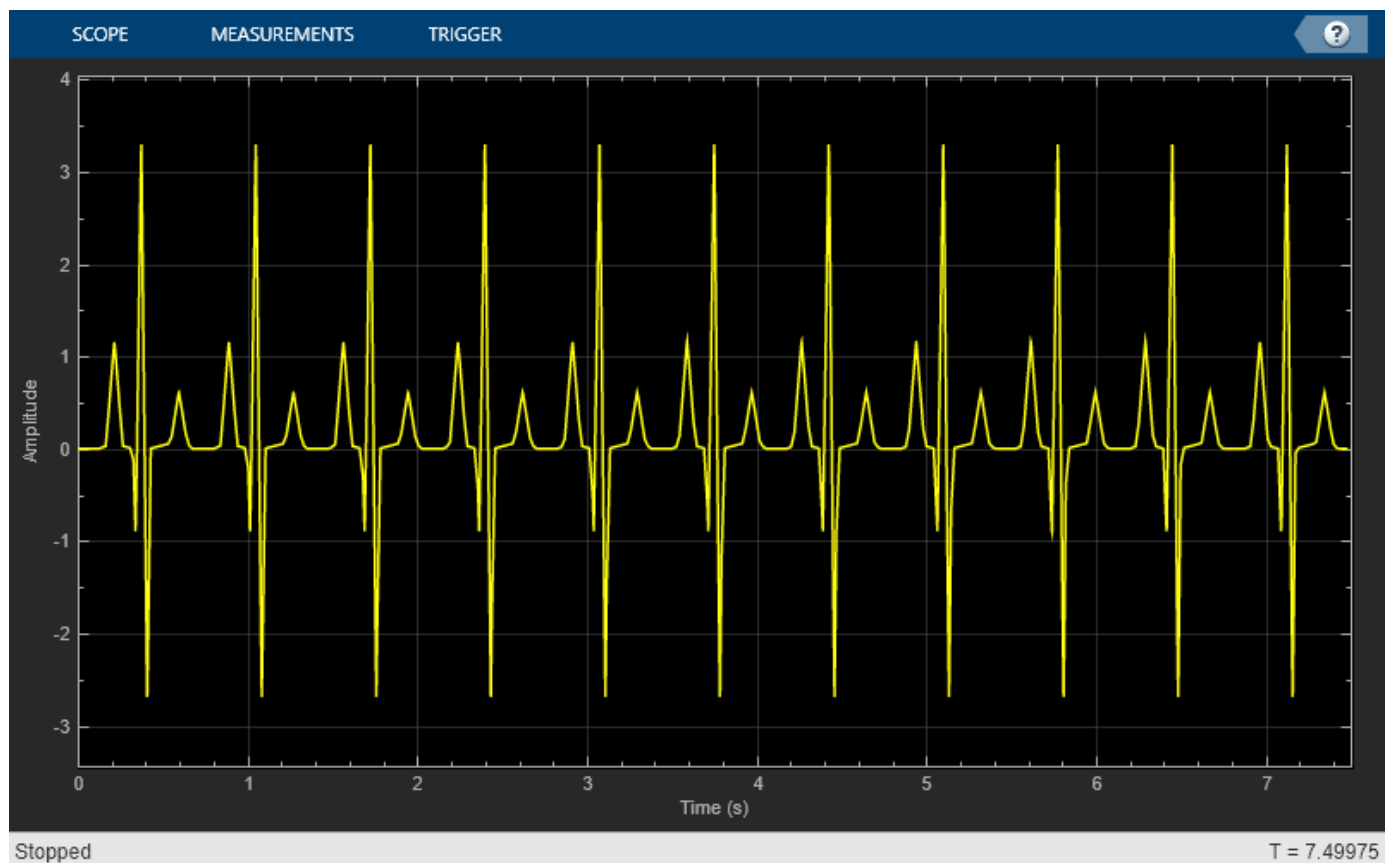

Find Heart Rate

Use the Peak Finder measurements to measure the time between heart beats.

- 1 On the **Measurements** tab, select **Peak Finder**.
- 2 For the **Num Peaks** property, enter 10.

In the **Peaks** pane at the bottom of the window, the Time Scope displays a list of ten peak amplitude values and the times at which they occur.

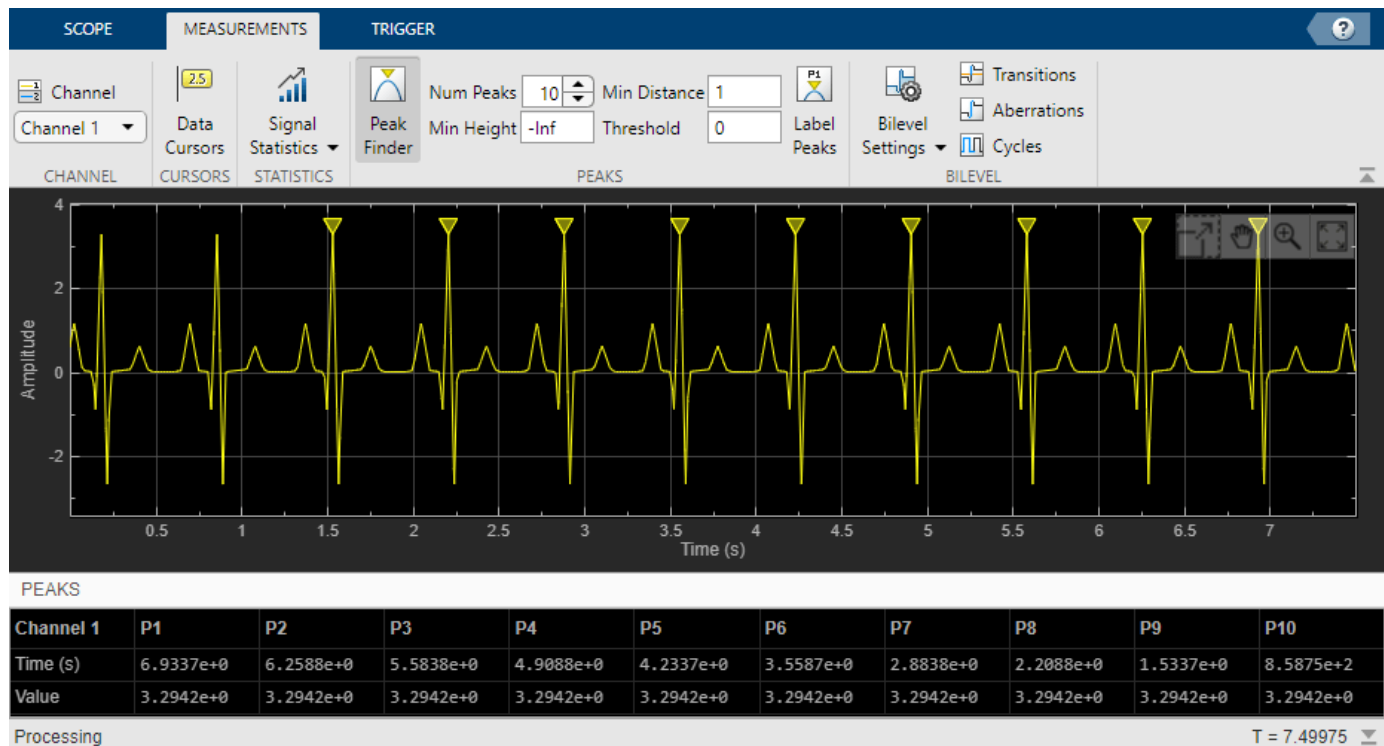

The list of peak values shows a constant time difference of 0.675 second between each heartbeat. Based on the following equation, the heart rate of this ECG signal is about 89 beats per minute.

$$\frac{60 \text{ s/min}}{0.675 \text{ s/beat}} = 88.89 \text{ bpm}$$

Close the Time Scope window and remove the variables you created from the workspace.

```
clear scope x1 y1 n del mhb ts
```

See Also

Topics

“Configure Time Scope MATLAB Object”

Introduced in R2020a

generateScript

Generate MATLAB script to create scope with current settings

Syntax

```
generateScript(scope)
```

Description

`generateScript(scope)` generates a MATLAB script that can re-create a `timescope` object with the current settings in the scope.

Examples

Generate Script from `timescope`

Generate MATLAB script after making changes to the `timescope` object in the scope window.

Note The script only generates commands for settings that are available from the command line, applicable to the current visualization, and changed from the default value.

- 1 Create a `timescope` object.

```
scope = timescope;  
show(scope)
```

- 2 Set options in the Time Scope. For this example, on the **Scope** tab, click **Settings**. Under **Display and Labels**, select **Show Legend** and **Magnitude Phase Plot**. Set the **Title** as well.

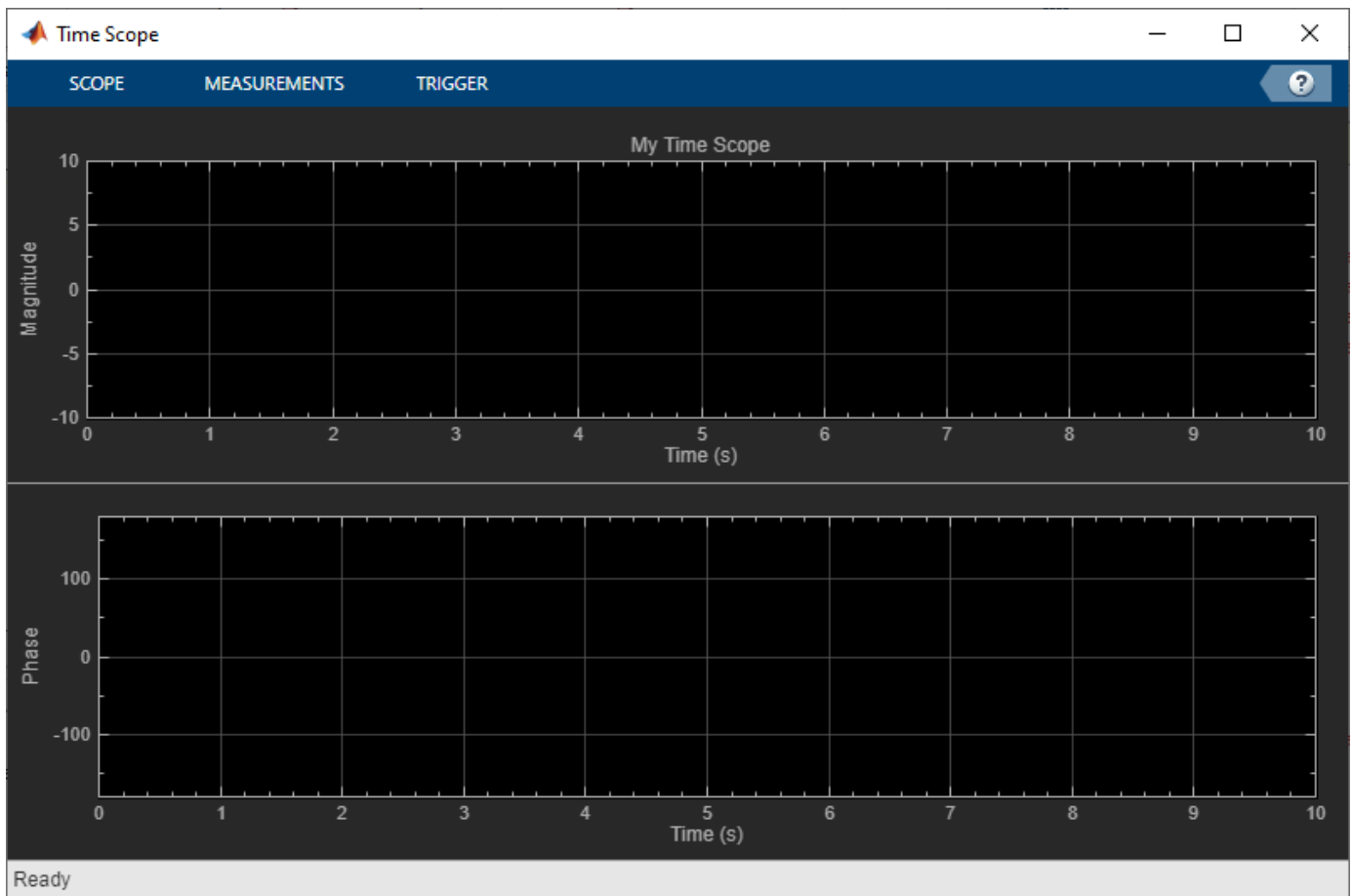

- 3 Generate a script to recreate the timescope with the same modified settings. Either select **Generate Script** from the **Scope** tab, or enter:

```
generateScript(scope);
```

A new editor window opens with code to regenerate the same scope.

```
% Creation Code for 'timescope'.
% Generated by Time Scope on 8-Nov-2019 13:51:54 -0500.

timescope('Position',[2286 355 800 500], ...
    'Title','My Time Scope', ...
    'ShowLegend',true, ...
    'PlotAsMagnitudePhase',true);
```

Input Arguments

scope — object

timescope object

Object whose settings you want to recreate with a script.

See Also

Functions

hide | isVisible | show

Objects
timescope

Introduced in R2020a

hide

Hide scope window

Syntax

```
hide(scope)
```

Description

`hide(scope)` hides the scope window.

Examples

View Sine Wave on Time Scope

Create a time-domain sinusoidal signal. Display the signal by calling the time scope object.

Create a sinusoidal signal with two tones, one at 0.3 kHz and the other at 3 kHz.

```
t = (0:1000)'/8e3;  
xin = sin(2*pi*0.3e3*t)+sin(2*pi*3e3*t);
```

Create a `timescope` object and view the sinusoidal signal by calling the time scope object `scope`.

```
scope = timescope('SampleRate', 8e3,...  
    'TimeSpanSource', 'property', ...  
    'TimeSpan', 0.1);  
scope(xin)
```

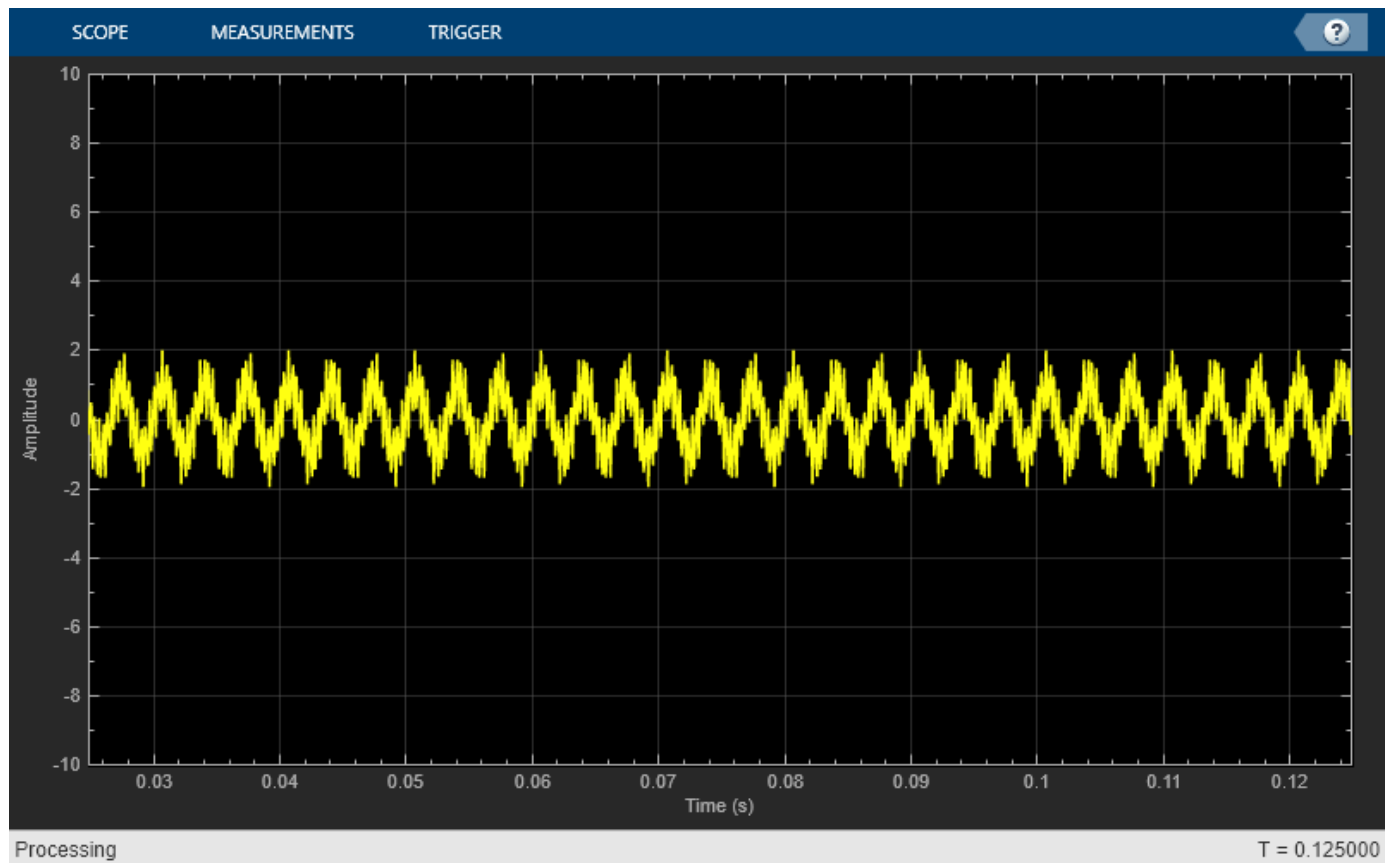

Run `release` to allow changes to property values and input characteristics. The scope automatically scales the axes.

```
release(scope);
```

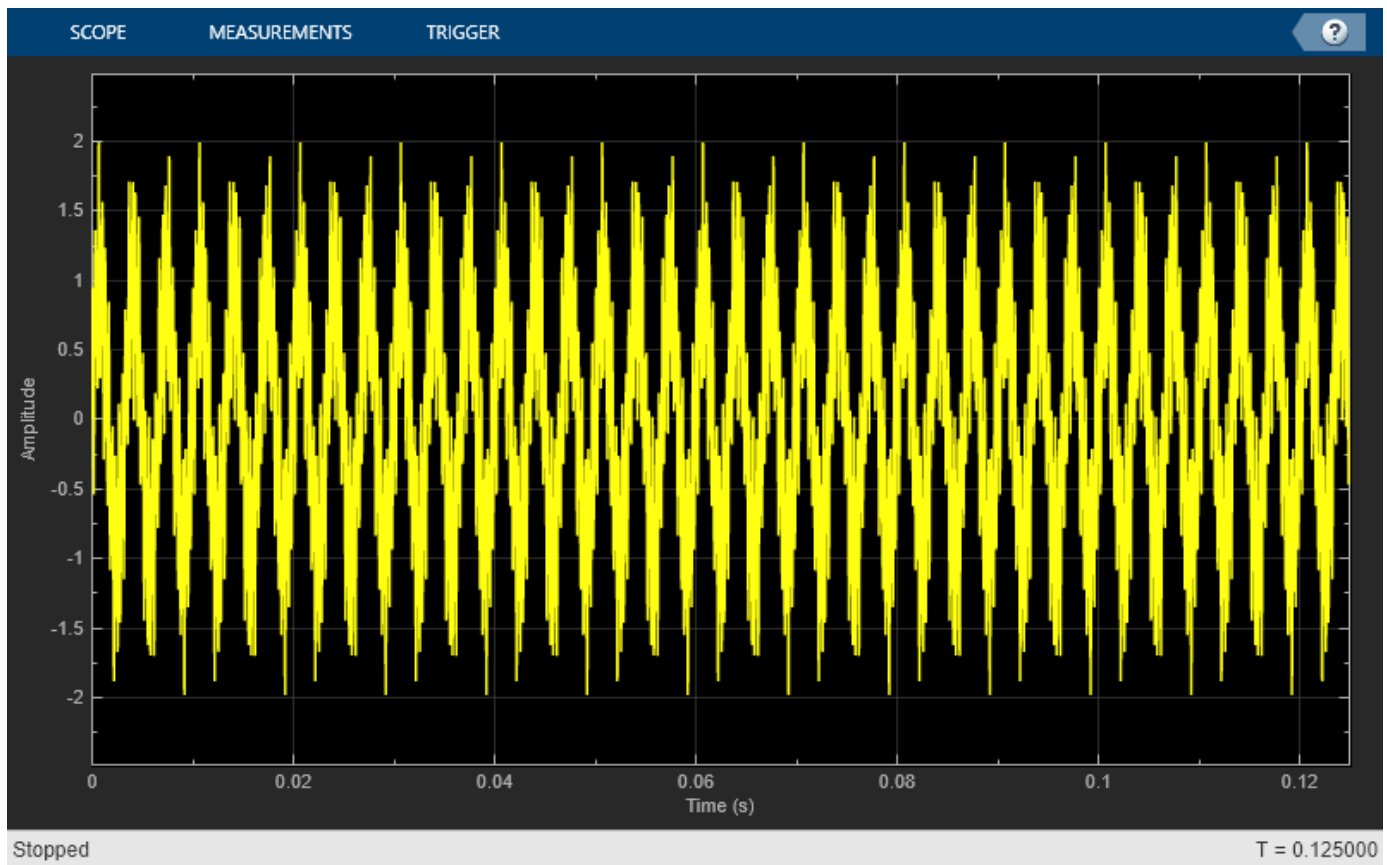

Hide the scope window.

```
if(isVisible(scope))  
    hide(scope)  
end
```

Show the scope window.

```
if(~isVisible(scope))  
    show(scope)  
end
```

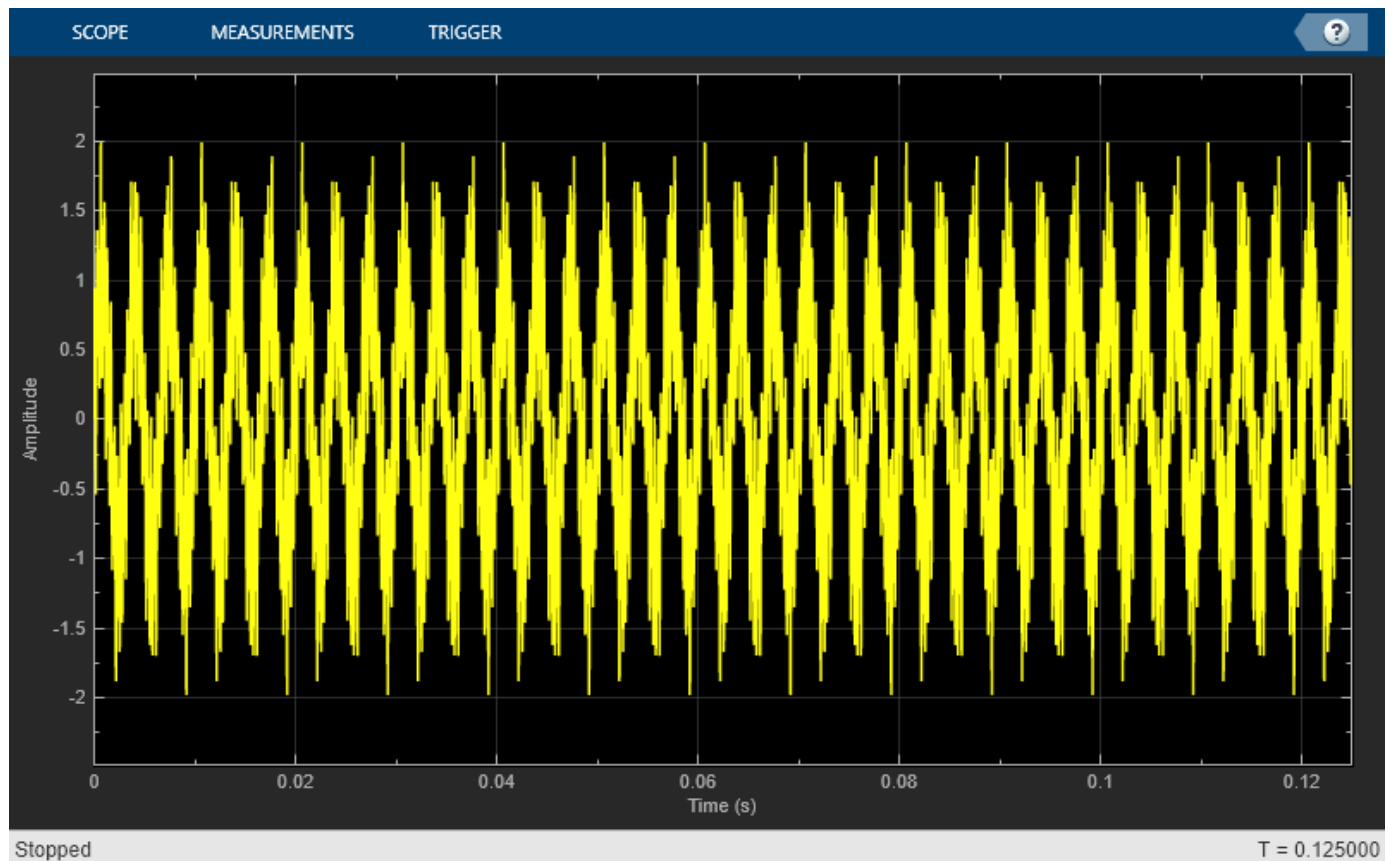

Input Arguments

scope — Scope object
timescope object

Scope object whose window you want to hide, specified as a `timescope` object.

Example: `myScope = timescope; hide(myScope)`

See Also

Functions

`generateScript` | `isVisible` | `show`

Objects

`timescope`

Introduced in R2020a

isVisible

Determine visibility of scope

Syntax

```
visibility = isVisible(scope)
```

Description

`visibility = isVisible(scope)` returns the visibility of the scope as logical, with 1 (true) for visible.

Examples

View Sine Wave on Time Scope

Create a time-domain sinusoidal signal. Display the signal by calling the time scope object.

Create a sinusoidal signal with two tones, one at 0.3 kHz and the other at 3 kHz.

```
t = (0:1000)'/8e3;  
xin = sin(2*pi*0.3e3*t)+sin(2*pi*3e3*t);
```

Create a `timescope` object and view the sinusoidal signal by calling the time scope object `scope`.

```
scope = timescope('SampleRate', 8e3, ...  
    'TimeSpanSource', 'property', ...  
    'TimeSpan', 0.1);  
scope(xin)
```

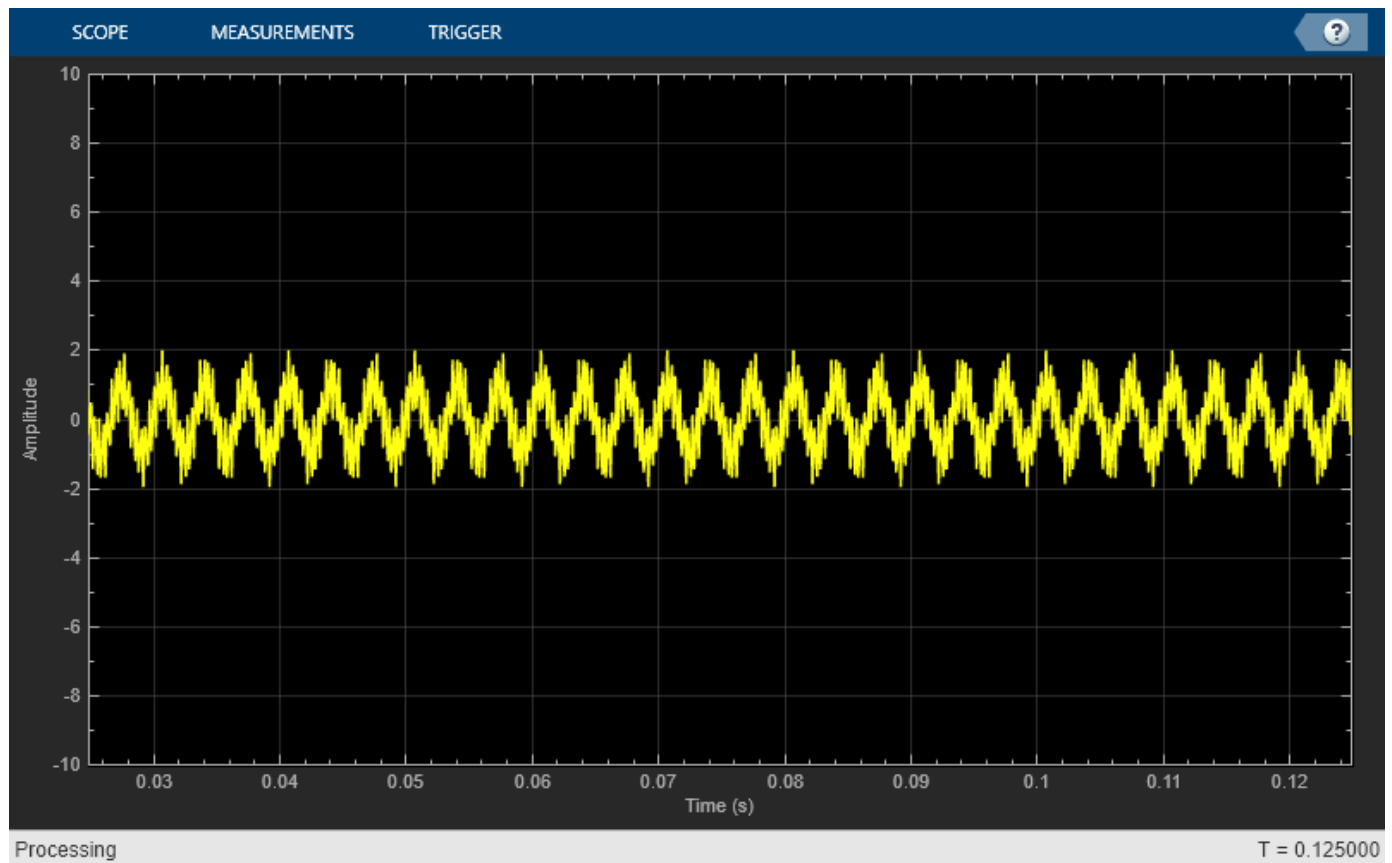

Run `release` to allow changes to property values and input characteristics. The scope automatically scales the axes.

```
release(scope);
```

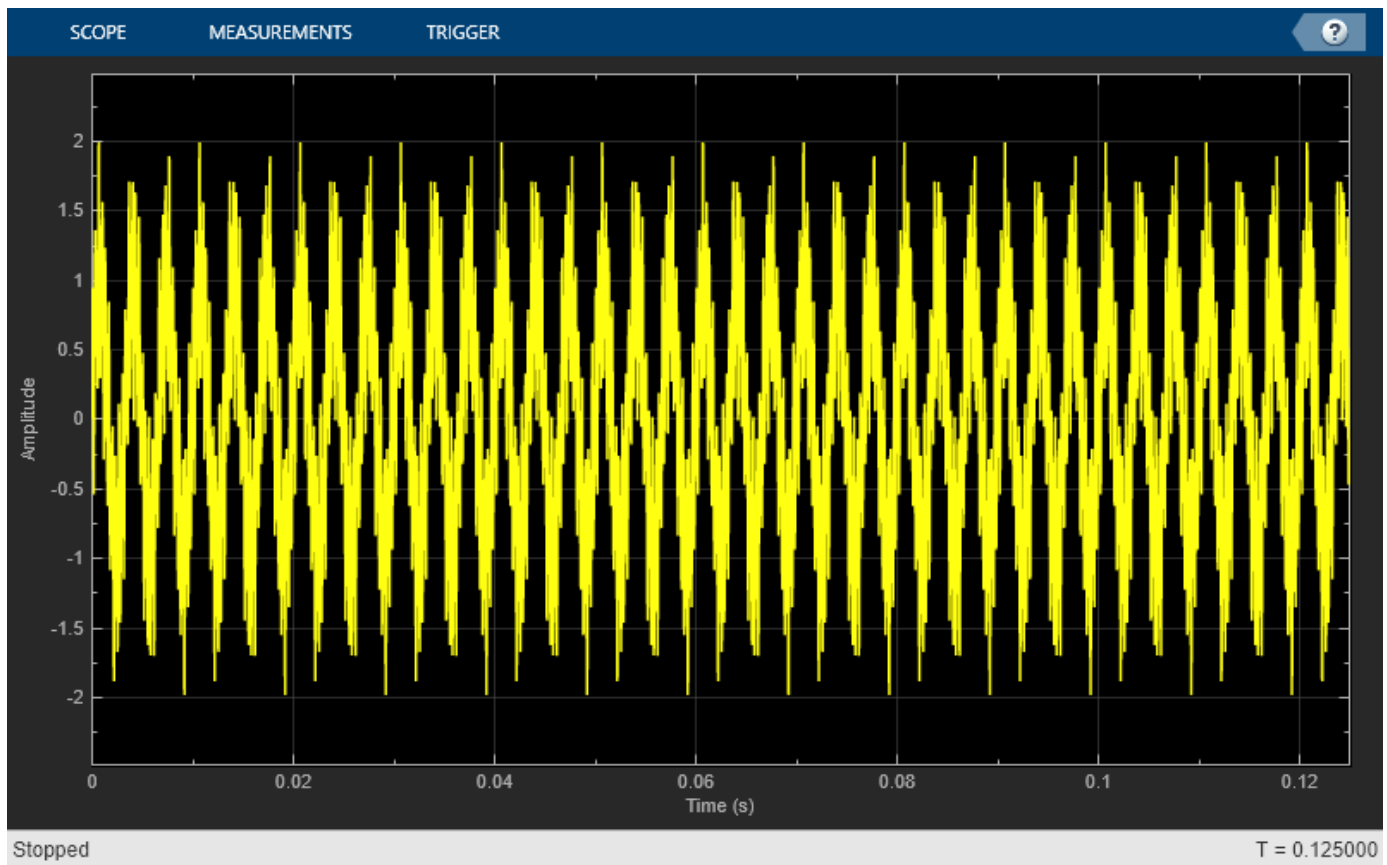

Hide the scope window.

```
if(isVisible(scope))  
    hide(scope)  
end
```

Show the scope window.

```
if(~isVisible(scope))  
    show(scope)  
end
```

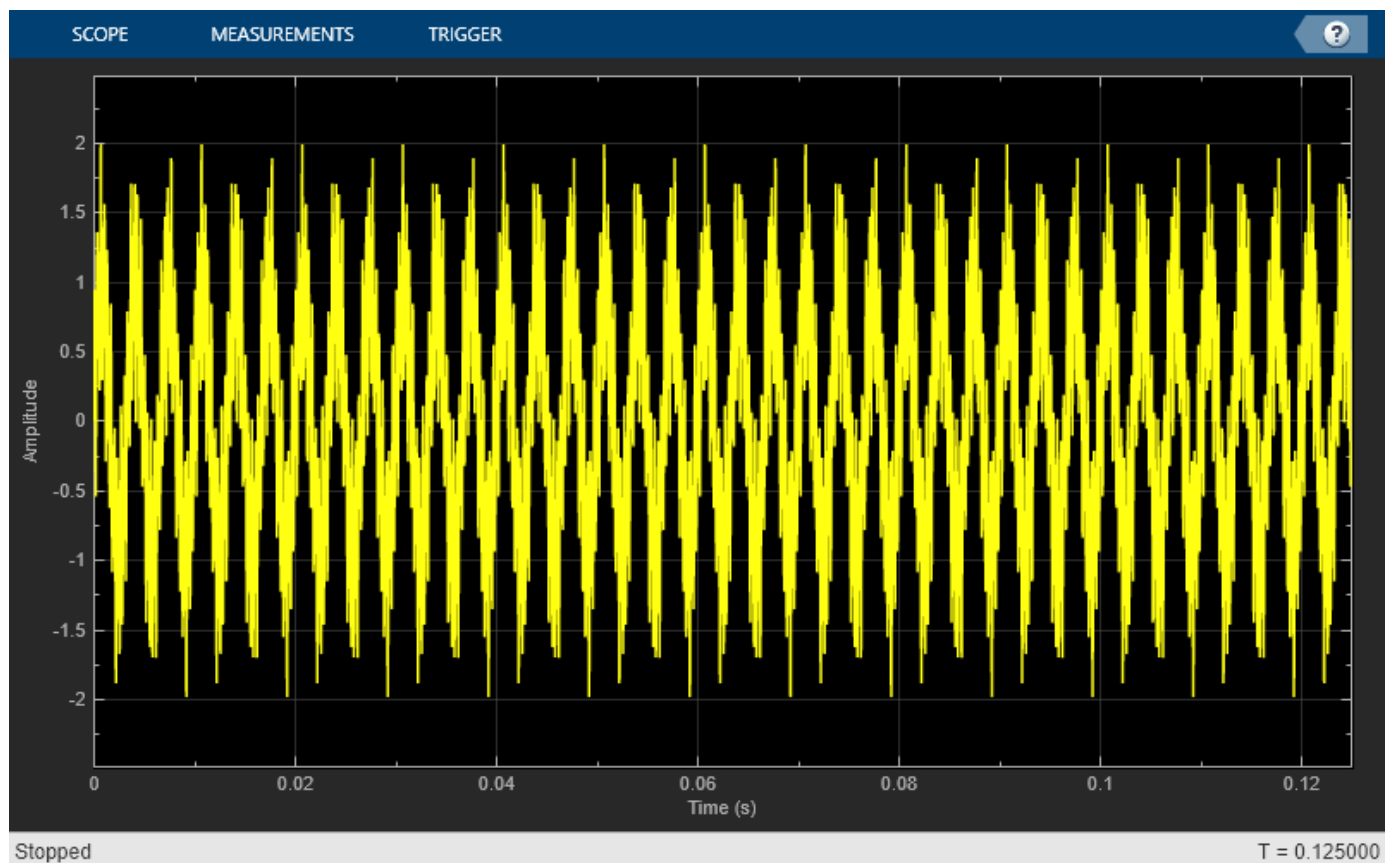

Input Arguments

scope — Scope object

timescope object

Scope object whose visibility you want to query.

Example: `myScope = timescope; visibility = isVisible(myScope)`

Output Arguments

visibility — Scope visibility

1 | 0

If the scope window is open, the `isVisible` function returns 1 (true). Otherwise, the function returns 0 (false).

See Also

Functions

`generateScript` | `hide` | `show`

Objects

timescope

Introduced in R2020a

show

Display scope window

Syntax

```
show(scope)
```

Description

`show(scope)` shows the scope window.

Examples

View Sine Wave on Time Scope

Create a time-domain sinusoidal signal. Display the signal by calling the time scope object.

Create a sinusoidal signal with two tones, one at 0.3 kHz and the other at 3 kHz.

```
t = (0:1000)'/8e3;  
xin = sin(2*pi*0.3e3*t)+sin(2*pi*3e3*t);
```

Create a `timescope` object and view the sinusoidal signal by calling the time scope object `scope`.

```
scope = timescope('SampleRate', 8e3,...  
    'TimeSpanSource', 'property', ...  
    'TimeSpan', 0.1);  
scope(xin)
```

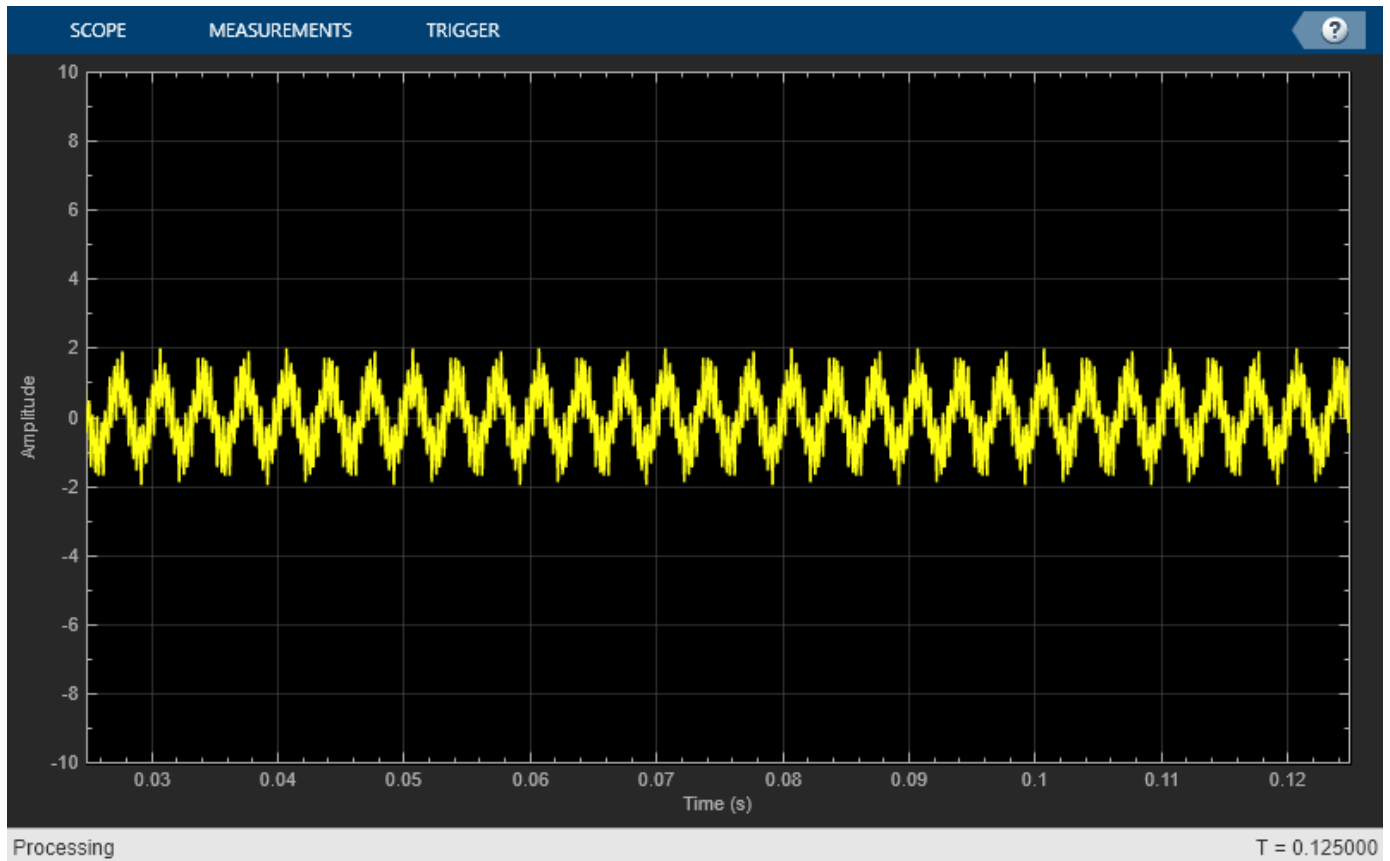

Run `release` to allow changes to property values and input characteristics. The scope automatically scales the axes.

```
release(scope);
```

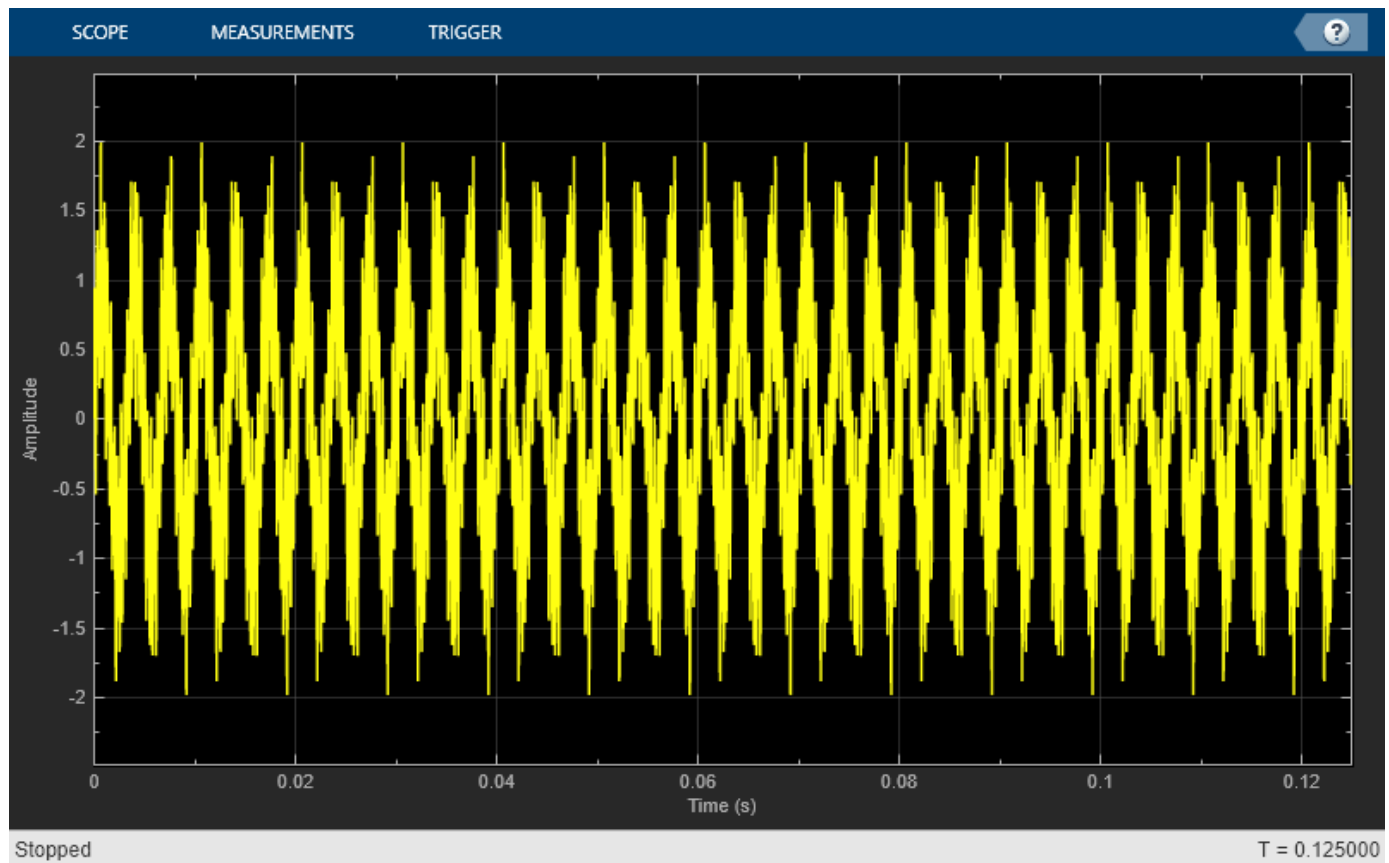

Hide the scope window.

```
if(isVisible(scope))  
    hide(scope)  
end
```

Show the scope window.

```
if(~isVisible(scope))  
    show(scope)  
end
```

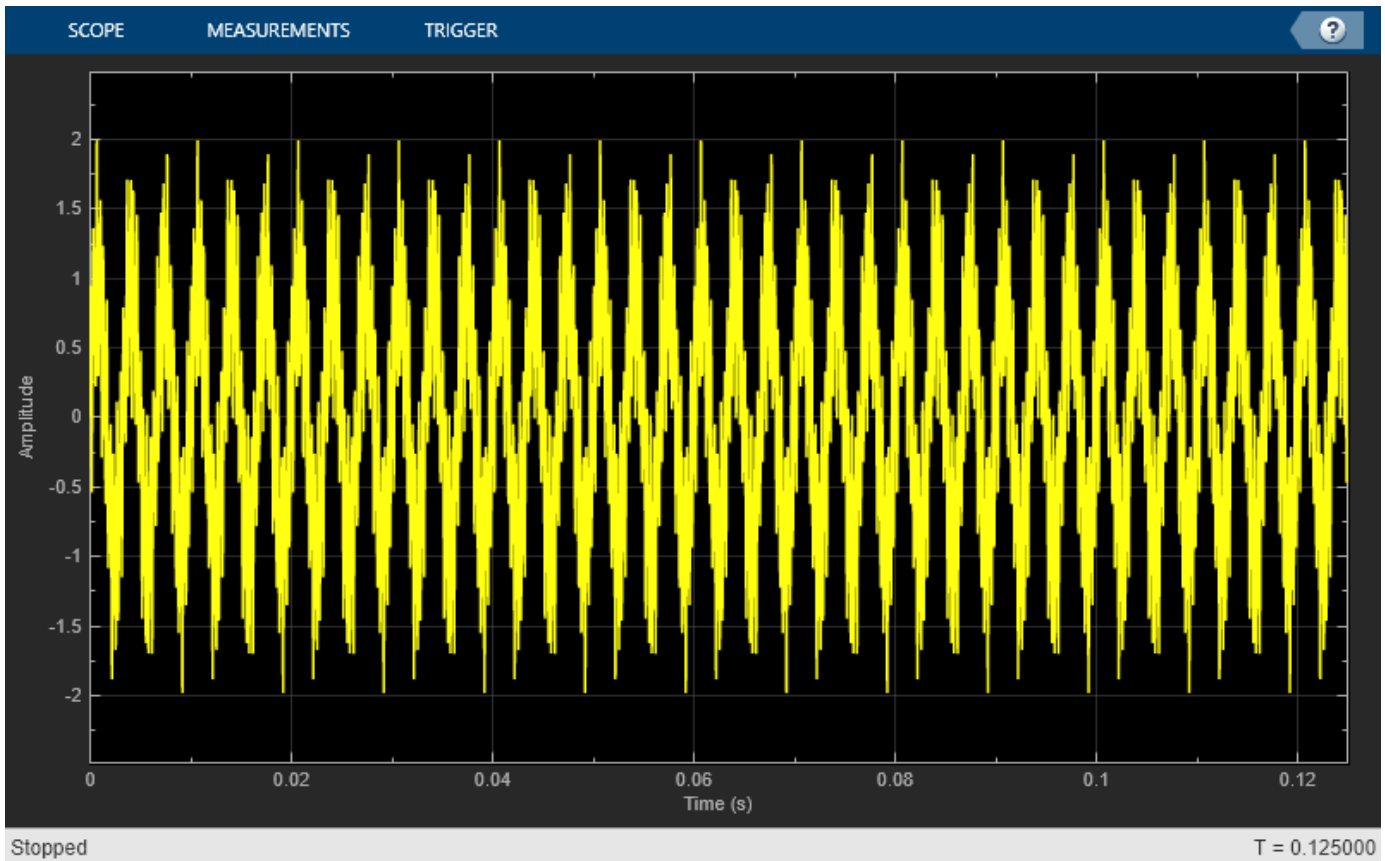

Input Arguments

scope — Scope object
timescope object

Scope object whose window you want to show, specified as a `timescope` object.

Example: `myScope = timescope; show(myScope)`

See Also

Functions

`generateScript` | `hide` | `isVisible`

Objects

`timescope`

Introduced in R2020a

Blocks

AHRS

Orientation from accelerometer, gyroscope, and magnetometer readings

Library: Navigation Toolbox Toolbox / Multisensor Positioning /
Navigation Filters
Sensor Fusion and Tracking Toolbox / Multisensor
Positioning / Navigation Filters

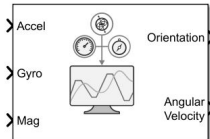

Description

The AHRS Simulink® block fuses accelerometer, magnetometer, and gyroscope sensor data to estimate device orientation.

Ports

Input

Accel — Accelerometer readings in sensor body coordinate system (m/s²)

N-by-3 matrix of real scalar

Accelerometer readings in the sensor body coordinate system in m/s², specified as an *N*-by-3 matrix of real scalars. *N* is the number of samples, and the three columns of `Accel` represent the [x y z] measurements, respectively.

Data Types: `single` | `double`

Gyro — Gyroscope readings in sensor body coordinate system (rad/s)

N-by-3 matrix of real scalar

Gyroscope readings in the sensor body coordinate system in rad/s, specified as an *N*-by-3 matrix of real scalars. *N* is the number of samples, and the three columns of `Gyro` represent the [x y z] measurements, respectively.

Data Types: `single` | `double`

Mag — Magnetometer readings in sensor body coordinate system (μT)

N-by-3 matrix of real scalar

Magnetometer readings in the sensor body coordinate system in μT, specified as an *N*-by-3 matrix of real scalars. *N* is the number of samples, and the three columns of `magReadings` represent the [x y z] measurements, respectively.

Data Types: `single` | `double`

Output

Orientation — Orientation of sensor body frame relative to navigation frame

M-by-4 array of scalar | 3-by-3-by-*M*-element rotation matrix

Orientation of the sensor body frame relative to the navigation frame, return as an M -by-4 array of scalars or a 3-by-3-by- M array of rotation matrices. Each row the of the N -by-4 array is assumed to be the four elements of a quaternion. The number of input samples, N , and the **Decimation Factor** parameter determine the output size M .

Data Types: single | double

Angular Velocity — Angular velocity in sensor body coordinate system (rad/s)

M -by-3 array of real scalar (default)

Angular velocity with gyroscope bias removed in the sensor body coordinate system in rad/s, returned as an M -by-3 array of real scalars. The number of input samples, N , and the **Decimation Factor** parameter determine the output size M .

Data Types: single | double

Parameters

Main

Reference frame — Navigation reference frame

NED (default) | ENU

Navigation reference frame, specified as NED (North-East-Down) or ENU (East-North-Up).

Decimation factor — Decimation factor

1 (default) | positive integer

Decimation factor by which to reduce the input sensor data rate, specified as a positive integer.

The number of rows of the inputs -- **Accel**, **Gyro**, and **Mag** -- must be a multiple of the decimation factor.

Data Types: single | double

Initial process noise — Initial process noise

ahrsfilter.defaultProcessNoise (default) | 12-by-12 matrix of real scalar

Initial process noise, specified as a 12-by-12 matrix of real scalars. The default value, `ahrsfilter.defaultProcessNoise`, is a 12-by-12 diagonal matrix as:

Columns 1 through 6

0.000006092348396	0	0	0	0	0						
0	0.000006092348396	0	0	0	0						
0	0	0.000006092348396	0	0	0						
0	0	0	0.000076154354947	0	0						
0	0	0	0	0.000076154354947	0						
0	0	0	0	0	0.000076154354947						
0	0	0	0	0	0						
0	0	0	0	0	0						
0	0	0	0	0	0						
0	0	0	0	0	0						
0	0	0	0	0	0						
0	0	0	0	0	0						

Columns 7 through 12

```

0 0 0 0
0 0 0 0
0 0 0 0
0 0 0 0
0 0 0 0
0 0 0 0
0.009623610000000 0 0 0
0 0.009623610000000 0 0
0 0 0.009623610000000 0
0 0 0 0.600000000000000
0 0 0 0 0.600000000000
0 0 0 0 0

```

Data Types: single | double

Orientation format — Orientation output format

'quaternion' (default) | 'Rotation matrix'

Output orientation format, specified as 'quaternion' or 'Rotation matrix':

- 'quaternion' -- Output is an M -by-4 array of real scalars. Each row of the array represents the four components of a quaternion.
- 'Rotation matrix' -- Output is a 3-by-3-by- M rotation matrix.

The output size M depends on the input dimension N and the **Decimation Factor** parameter.

Data Types: char | string

Simulate using — Type of simulation to run

Interpreted Execution (default) | Code Generation

- **Interpreted execution** — Simulate the model using the MATLAB interpreter. This option shortens startup time. In Interpreted execution mode, you can debug the source code of the block.
- **Code generation** — Simulate the model using generated C code. The first time you run a simulation, Simulink generates C code for the block. The C code is reused for subsequent simulations as long as the model does not change. This option requires additional startup time.

Measurement Noise

Accelerometer noise $((\text{m/s}^2)^2)$ — Variance of accelerometer signal noise $((\text{m/s}^2)^2)$

0.00019247 (default) | positive real scalar

Variance of accelerometer signal noise in $(\text{m/s}^2)^2$, specified as a positive real scalar.

Data Types: single | double

Gyroscope noise $((\text{rad/s})^2)$ — Variance of gyroscope signal noise $((\text{rad/s})^2)$

9.1385e-5 (default) | positive real scalar

Variance of gyroscope signal noise in $(\text{rad/s})^2$, specified as a positive real scalar.

Data Types: single | double

Magnetometer noise (μT^2) — Variance of magnetometer signal noise (μT^2)

0.1 (default) | positive real scalar

Variance of magnetometer signal noise in μT^2 , specified as a positive real scalar.

Data Types: single | double

Gyroscope drift noise (rad/s) — Variance of gyroscope offset drift ((rad/s)²)

3.0462e-13 (default) | positive real scalar

Variance of gyroscope offset drift in (rad/s)², specified as a positive real scalar.

Data Types: single | double

Environmental Noise

Linear acceleration noise ((m/s²)²) — Variance of linear acceleration noise (m/s²)²

0.0096236 (default) | positive real scalar

Variance of linear acceleration noise in (m/s²)², specified as a positive real scalar. Linear acceleration is modeled as a lowpass-filtered white noise process.

Data Types: single | double

Magnetic disturbance noise (μT^2) — Variance of magnetic disturbance noise (μT^2)

0.5 (default) | real finite positive scalar

Variance of magnetic disturbance noise in μT^2 , specified as a real finite positive scalar.

Data Types: single | double

Linear acceleration decay factor — Decay factor for linear acceleration drift

0.5 (default) | scalar in the range [0,1]

Decay factor for linear acceleration drift, specified as a scalar in the range [0,1]. If linear acceleration changes quickly, set this parameter to a lower value. If linear acceleration changes slowly, set this parameter to a higher value. Linear acceleration drift is modeled as a lowpass-filtered white noise process.

Data Types: single | double

Magnetic disturbance decay factor — Decay factor for magnetic disturbance

0.5 (default) | positive scalar in the range [0,1]

Decay factor for magnetic disturbance, specified as a positive scalar in the range [0,1]. Magnetic disturbance is modeled as a first order Markov process.

Data Types: single | double

Magnetic field strength (μT) — Magnetic field strength (μT)

50 (default) | real positive scalar

Magnetic field strength in μT , specified as a real positive scalar. The magnetic field strength is an estimate of the magnetic field strength of the Earth at the current location.

Data Types: single | double

Algorithms

Note: The following algorithm only applies to an NED reference frame.

The AHRS block uses the nine-axis Kalman filter structure described in [1]. The algorithm attempts to track the errors in orientation, gyroscope offset, linear acceleration, and magnetic disturbance to output the final orientation and angular velocity. Instead of tracking the orientation directly, the indirect Kalman filter models the error process, x , with a recursive update:

$$x_k = \begin{bmatrix} \theta_k \\ b_k \\ a_k \\ d_k \end{bmatrix} = F_k \begin{bmatrix} \theta_{k-1} \\ b_{k-1} \\ a_{k-1} \\ d_{k-1} \end{bmatrix} + w_k$$

where x_k is a 12-by-1 vector consisting of:

- θ_k -- 3-by-1 orientation error vector, in degrees, at time k
- b_k -- 3-by-1 gyroscope zero angular rate bias vector, in deg/s, at time k
- a_k -- 3-by-1 acceleration error vector measured in the sensor frame, in g, at time k
- d_k -- 3-by-1 magnetic disturbance error vector measured in the sensor frame, in μT , at time k

and where w_k is a 12-by-1 additive noise vector, and F_k is the state transition model.

Because x_k is defined as the error process, the *a priori* estimate is always zero, and therefore the state transition model, F_k , is zero. This insight results in the following reduction of the standard Kalman equations:

Standard Kalman equations:

$$\begin{aligned} x_k^- &= F_k x_{k-1}^+ \\ P_k^- &= F_k P_{k-1}^+ F_k^T + Q_k \\ y_k &= z_k - H_k x_k^- \\ S_k &= R_k + H_k P_k^- H_k^T \\ K_k &= P_k^- H_k^T (S_k)^{-1} \\ x_k^+ &= x_k^- + K_k y_k \\ P_k^+ &= P_k^- - K_k H_k P_k^- \end{aligned}$$

Kalman equations used in this algorithm:

$$\begin{aligned} x_k^- &= 0 \\ P_k^- &= Q_k \\ y_k &= z_k \\ S_k &= R_k + H_k P_k^- H_k^T \\ K_k &= P_k^- H_k^T (S_k)^{-1} \\ x_k^+ &= K_k y_k \\ P_k^+ &= P_k^- - K_k H_k P_k^- \end{aligned}$$

where:

- x_k^- -- predicted (*a priori*) state estimate; the error process
- P_k^- -- predicted (*a priori*) estimate covariance
- y_k -- innovation
- S_k -- innovation covariance
- K_k -- Kalman gain
- x_k^+ -- updated (*a posteriori*) state estimate
- P_k^+ -- updated (*a posteriori*) estimate covariance

k represents the iteration, the superscript $+$ represents an *a posteriori* estimate, and the superscript $-$ represents an *a priori* estimate.

The graphic and following steps describe a single frame-based iteration through the algorithm.

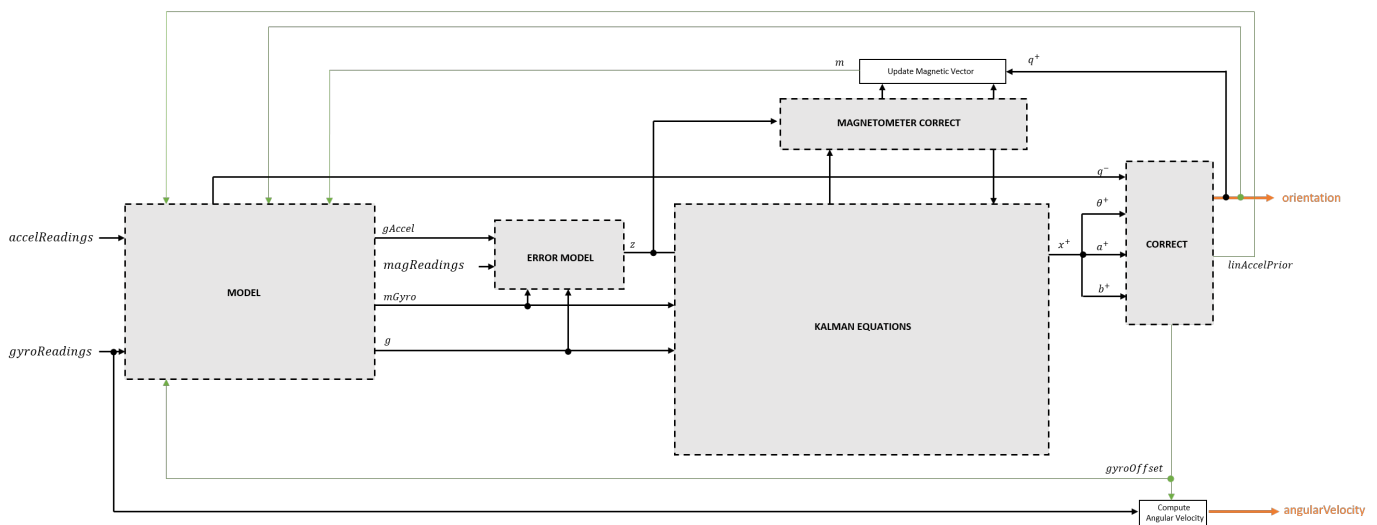

Before the first iteration, the *accelReadings*, *gyroReadings*, and *magReadings* inputs are chunked into DecimationFactor-by-3 frames. For each chunk, the algorithm uses the most current accelerometer and magnetometer readings corresponding to the chunk of gyroscope readings.

Detailed Overview

Walk through the algorithm for an explanation of each stage of the detailed overview.

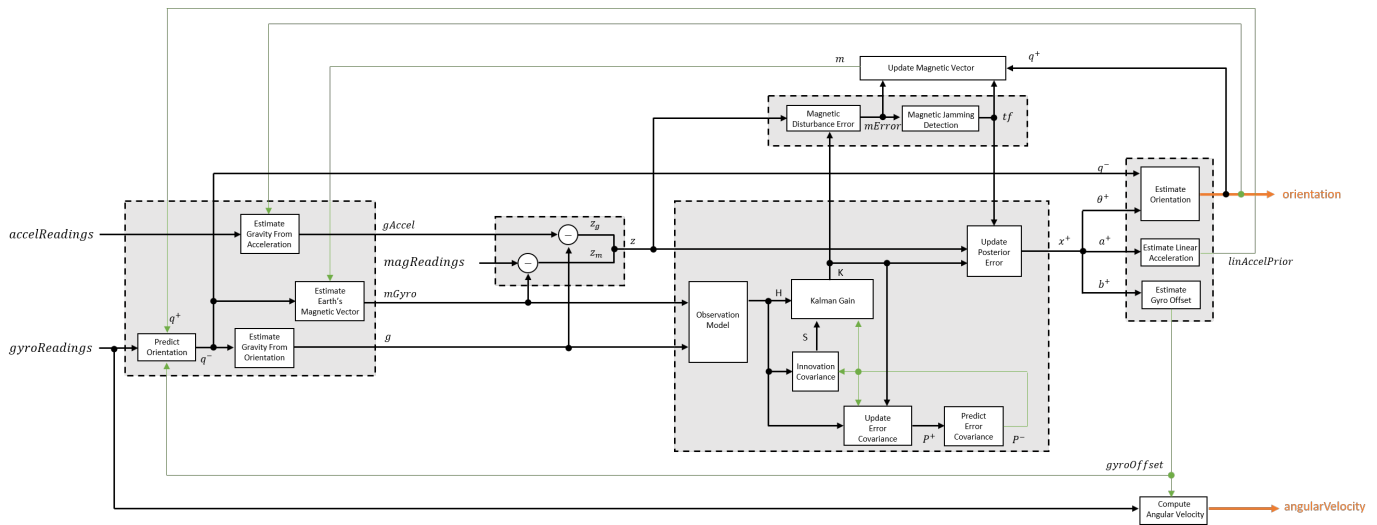

Model

The algorithm models acceleration and angular change as linear processes.

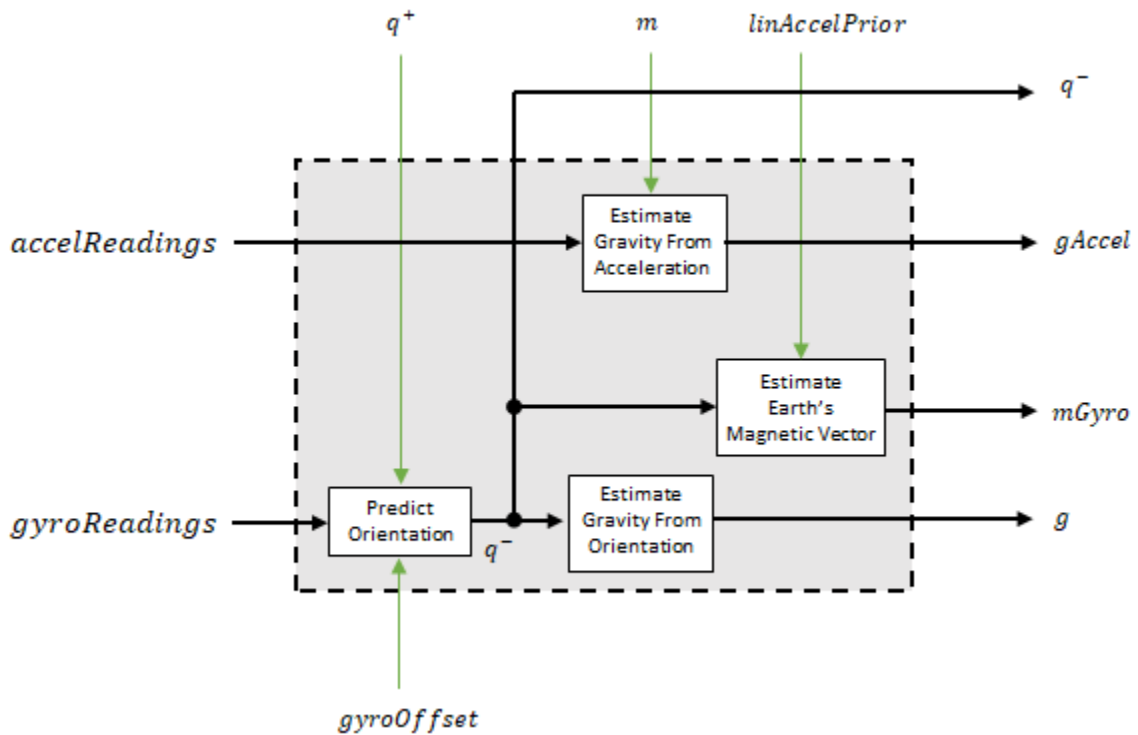

Predict Orientation

The orientation for the current frame is predicted by first estimating the angular change from the previous frame:

$$\Delta\varphi_{N \times 3} = \frac{(gyroReadings_{N \times 3} - gyroOffset_1 \times 3)}{f_s}$$

where N is the decimation factor specified by the Decimation factor and fs is the sample rate.

The angular change is converted into quaternions using the `rotvec` quaternion construction syntax:

$$\Delta Q_{N \times 1} = \text{quaternion}(\Delta\varphi_{N \times 3}, 'rotvec')$$

The previous orientation estimate is updated by rotating it by ΔQ :

$$q_{1 \times 1}^- = (q_{1 \times 1}^+) \left(\prod_{n=1}^N \Delta Q_n \right)$$

During the first iteration, the orientation estimate, q^- , is initialized by `ecompass`.

Estimate Gravity from Orientation

The gravity vector is interpreted as the third column of the quaternion, q^- , in rotation matrix form:

$$g_{1 \times 3} = (rPrior(:, 3))^T$$

Estimate Gravity from Acceleration

A second gravity vector estimation is made by subtracting the decayed linear acceleration estimate of the previous iteration from the accelerometer readings:

$$gAccel_{1 \times 3} = accelReadings_{1 \times 3} - linAccelPrior_{1 \times 3}$$

Estimate Earth's Magnetic Vector

Earth's magnetic vector is estimated by rotating the magnetic vector estimate from the previous iteration by the *a priori* orientation estimate, in rotation matrix form:

$$mGyro_{1 \times 3} = ((rPrior)(m^T))^T$$

Error Model

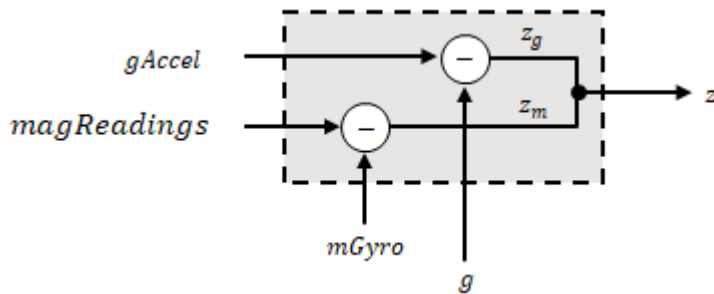

The error model combines two differences:

- The difference between the gravity estimate from the accelerometer readings and the gravity estimate from the gyroscope readings: $z_g = g - gAccel$
- The difference between the magnetic vector estimate from the gyroscope readings and the magnetic vector estimate from the magnetometer: $z_m = mGyro - magReadings$

Magnetometer Correct

The magnetometer correct estimates the error in the magnetic vector estimate and detects magnetic jamming.

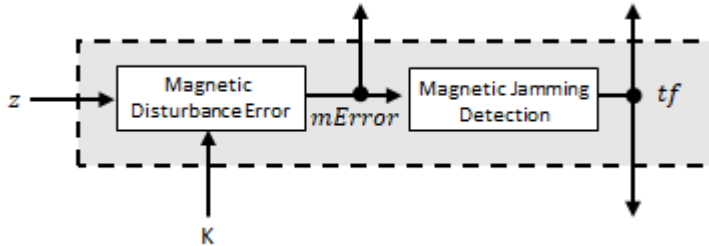

Magnetometer Disturbance Error

The magnetic disturbance error is calculated by matrix multiplication of the Kalman gain associated with the magnetic vector with the error signal:

$$mError_{3 \times 1} = \left((K(10:12, :)_{3 \times 6})(z_{1 \times 6})^T \right)^T$$

The Kalman gain, K , is the Kalman gain calculated in the current iteration.

Magnetic Jamming Detection

Magnetic jamming is determined by verifying that the power of the detected magnetic disturbance is less than or equal to four times the power of the expected magnetic field strength:

$$tf = \begin{cases} \text{true} & \text{if } \sum |mError|^2 > (4)(\text{ExpectedMagneticFieldStrength})^2 \\ \text{false} & \text{else} \end{cases}$$

ExpectedMagneticFieldStrength is a property of `ahrsfilter`.

Kalman Equations

The Kalman equations use the gravity estimate derived from the gyroscope readings, g , the magnetic vector estimate derived from the gyroscope readings, $mGyro$, and the observation of the error process, z , to update the Kalman gain and intermediary covariance matrices. The Kalman gain is applied to the error signal, z , to output an *a posteriori* error estimate, x^+ .

- H is the observation model matrix
- P^- is the predicted (*a priori*) estimate of the covariance of the observation model calculated in the previous iteration
- R is the covariance of the observation model noise, calculated as:

$$R_{6 \times 6} = \begin{bmatrix} accel_{noise} & 0 & 0 & 0 & 0 & 0 \\ 0 & accel_{noise} & 0 & 0 & 0 & 0 \\ 0 & 0 & accel_{noise} & 0 & 0 & 0 \\ 0 & 0 & 0 & mag_{noise} & 0 & 0 \\ 0 & 0 & 0 & 0 & mag_{noise} & 0 \\ 0 & 0 & 0 & 0 & 0 & mag_{noise} \end{bmatrix}$$

where

$$accel_{noise} = \text{AccelerometerNoise} + \text{LinearAccelerationNoise} + \kappa^2 \\ (\text{GyroscopeDriftNoise} + \text{GyroscopeNoise})$$

and

$$mag_{noise} = \text{MagnetometerNoise} + \text{MagneticDisturbanceNoise} + \kappa^2 \\ (\text{GyroscopeDriftNoise} + \text{GyroscopeNoise})$$

Update Error Estimate Covariance

The error estimate covariance is a 12-by-12 matrix used to track the variability in the state.

The error estimate covariance matrix is updated as:

$$P_{12 \times 12}^+ = P_{12 \times 12}^- - (K_{12 \times 6})(H_{6 \times 12})(P_{12 \times 12}^-)$$

where K is the Kalman gain, H is the measurement matrix, and P^- is the error estimate covariance calculated during the previous iteration.

Predict Error Estimate Covariance

The error estimate covariance is a 12-by-12 matrix used to track the variability in the state. The *a priori* error estimate covariance, P^- , is set to the process noise covariance, Q , determined during the previous iteration. Q is calculated as a function of the *a posteriori* error estimate covariance, P^+ . When calculating Q , it is assumed that the cross-correlation terms are negligible compared to the autocorrelation terms, and are set to zero:

Q =

$$\begin{bmatrix}
 P^+(1) + \kappa^2 P^+(40) + \beta + \eta & 0 & 0 & -\kappa(P^+(40) + \beta) & 0 \\
 0 & P^+(14) + \kappa^2 P^+(53) + \beta + \eta & 0 & 0 & -\kappa(P^+(53) + \beta) \\
 0 & 0 & P^+(27) + \kappa^2 P^+(66) + \beta + \eta & 0 & 0 \\
 -\kappa(P^+(40) + \beta) & 0 & 0 & P^+(40) + \beta & 0 \\
 0 & -\kappa(P^+(53) + \beta) & 0 & 0 & P^+(53) + \beta \\
 0 & 0 & -\kappa(P^+(66) + \beta) & 0 & 0 \\
 0 & 0 & 0 & 0 & 0 \\
 0 & 0 & 0 & 0 & 0 \\
 0 & 0 & 0 & 0 & 0 \\
 0 & 0 & 0 & 0 & 0 \\
 0 & 0 & 0 & 0 & 0 \\
 0 & 0 & 0 & 0 & 0 \\
 0 & 0 & 0 & 0 & 0
 \end{bmatrix}$$

where

- P^+ -- is the updated (*a posteriori*) error estimate covariance
- κ -- Decimation factor divided by sample rate.
- β -- Gyroscope drift noise.
- η -- Gyroscope noise.
- ν -- Linear acceleration decay factor.
- ξ -- Linear acceleration noise.
- σ -- Magnetic disturbance decay factor.
- γ -- Magnetic disturbance noise.

Kalman Gain

The Kalman gain matrix is a 12-by-6 matrix used to weight the innovation. In this algorithm, the innovation is interpreted as the error process, z .

The Kalman gain matrix is constructed as:

$$K_{12 \times 6} = (P_{12 \times 12}^-)(H_{6 \times 12})^T((S_{6 \times 6})^T)^{-1}$$

where

- P^- -- predicted error covariance
- H -- observation model
- S -- innovation covariance

Update a Posteriori Error

The *a posteriori* error estimate is determined by combining the Kalman gain matrix with the error in the gravity vector and magnetic vector estimations:

$$x_{12 \times 1} = (K_{12 \times 6})(z_{1 \times 6})^T$$

If magnetic jamming is detected in the current iteration, the magnetic vector error signal is ignored, and the *a posteriori* error estimate is calculated as:

$$x_{9 \times 1} = (K(1:9, 1:3))(z_g)^T$$

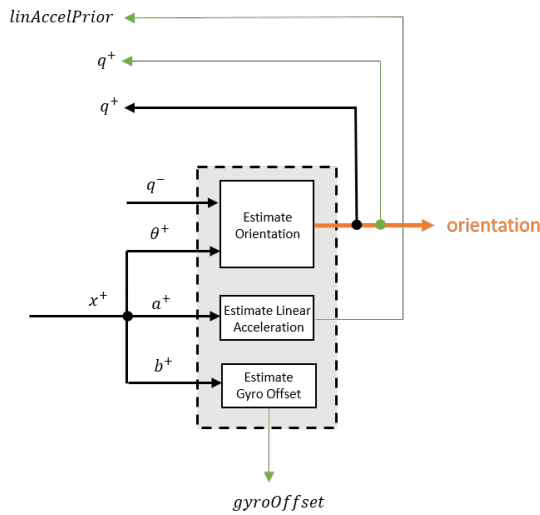
Correct**Estimate Orientation**

The orientation estimate is updated by multiplying the previous estimation by the error:

$$q^+ = (q^-)(\theta^+)$$

Estimate Linear Acceleration

The linear acceleration estimation is updated by decaying the linear acceleration estimation from the previous iteration and subtracting the error:

$$linAccelPrior = (linAccelPrior_{k-1})\nu - b^+$$

where

- ν -- Linear acceleration decay factor

Estimate Gyroscope Offset

The gyroscope offset estimation is updated by subtracting the gyroscope offset error from the gyroscope offset from the previous iteration:

$$gyroOffset = gyroOffset_{k-1} - a^+$$

Compute Angular Velocity

To estimate angular velocity, the frame of `gyroReadings` are averaged and the gyroscope offset computed in the previous iteration is subtracted:

$$angularVelocity_{1 \times 3} = \frac{\sum gyroReadings_{N \times 3}}{N} - gyroOffset_{1 \times 3}$$

where N is the decimation factor specified by the `DecimationFactor` property.

The gyroscope offset estimation is initialized to zeros for the first iteration.

Update Magnetic Vector

If magnetic jamming was not detected in the current iteration, the magnetic vector estimate, m , is updated using the *a posteriori* magnetic disturbance error and the *a posteriori* orientation.

The magnetic disturbance error is converted to the navigation frame:

$$mErrorNED_{1 \times 3} = \left((rPost_{3 \times 3})^T (mError_{1 \times 3})^T \right)^T$$

The magnetic disturbance error in the navigation frame is subtracted from the previous magnetic vector estimate and then interpreted as inclination:

$$M = m - mErrorNED$$

$$inclination = \text{atan2}(M(3), M(1))$$

The inclination is converted to a constrained magnetic vector estimate for the next iteration:

$$m(1) = (\text{ExpectedMagneticFieldStrength})(\cos(inclination))$$

$$m(2) = 0$$

$$m(3) = (\text{ExpectedMagneticFieldStrength})(\sin(inclination))$$

References

- [1] Open Source Sensor Fusion. <https://github.com/memsindustrygroup/Open-Source-Sensor-Fusion/tree/master/docs>
- [2] Roetenberg, D., H.J. Luinge, C.T.M. Baten, and P.H. Veltink. "Compensation of Magnetic Disturbances Improves Inertial and Magnetic Sensing of Human Body Segment Orientation." *IEEE Transactions on Neural Systems and Rehabilitation Engineering*. Vol. 13. Issue 3, 2005, pp. 395-405.

Extended Capabilities

C/C++ Code Generation

Generate C and C++ code using Simulink® Coder™.

See Also

`ahrsfilter` | `ecompass` | `gpsSensor` | `imuSensor` | `imufilter` | `quaternion`

Topics

"Determine Orientation Using Inertial Sensors"

Introduced in R2020a

Detection Concatenation

Combine detection reports from different sensors

Library: Automated Driving Toolbox
Sensor Fusion and Tracking Toolbox / Utilities

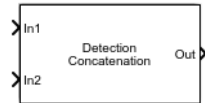

Description

The Detection Concatenation block combines detection reports from multiple sensors onto a single output bus. Concatenation is useful when detections from multiple sensor blocks are passed into a tracker block such as the Global Nearest Neighbor Multi Object Tracker block. You can accommodate additional sensors by changing the **Number of input sensors to combine** parameter to increase the number of input ports.

Ports

Input

In1, In2, ..., InN — Sensor detections to combine

Simulink buses containing MATLAB structures

Sensor detections to combine, where each detection is a Simulink bus containing a MATLAB structure. See “Create Nonvirtual Buses” (Simulink) for more details.

The structure has the form:

Field	Description	Type
NumDetections	Number of detections	integer
Detections	Object detections	Array of object detection structures. The first NumDetections of these detections are actual detections.

The fields of Detections are:

Field	Description	Type
Time	Measurement time	single or double
Measurement	Object measurements	single or double
MeasurementNoise	Measurement noise covariance matrix	single or double
SensorIndex	Unique ID of the sensor	single or double
ObjectClassID	Object classification ID	single or double

Field	Description	Type
MeasurementParameters	Parameters used by initialization functions of tracking filters	Simulink Bus
ObjectAttributes	Additional information passed to tracker	Simulink Bus

By default, the block includes two ports for input detections. To add more ports, use the **Number of input sensors to combine** parameter.

Output

Out — Combined sensor detections

Simulink bus containing MATLAB structure

Combined sensor detections from all input buses, returned as a Simulink bus containing a MATLAB structure. See “Create Nonvirtual Buses” (Simulink).

The structure has the form:

Field	Description	Type
NumDetections	Number of detections	integer
Detections	Object detections	Array of object detection structures. The first NumDetections of these detections are actual detections.

The fields of Detections are:

Field	Description	Type
Time	Measurement time	single or double
Measurement	Object measurements	single or double
MeasurementNoise	Measurement noise covariance matrix	single or double
SensorIndex	Unique ID of the sensor	single or double
ObjectClassID	Object classification ID	single or double
MeasurementParameters	Parameters used by initialization functions of tracking filters	Simulink Bus
ObjectAttributes	Additional information passed to tracker	Simulink Bus

The **Maximum number of reported detections** output is the sum of the **Maximum number of reported detections** of all input ports. The number of actual detections is the sum of the number of actual detections in each input port. The `ObjectAttributes` fields in the detection structure are the union of the `ObjectAttributes` fields in each input port.

Parameters

Number of input sensors to combine — Number of input sensor ports

2 (default) | positive integer

Number of input sensor ports, specified as a positive integer. Each input port is labeled **In1**, **In2**, ..., **InN**, where *N* is the value set by this parameter.

Data Types: double

Source of output bus name — Source of output bus name

Auto (default) | Property

Source of output bus name, specified as Auto or Property.

- If you select Auto, the block automatically generates a bus name.
- If you select Property, specify the bus name using the **Specify an output bus name** parameter.

Specify an output bus name — Name of output bus

no default

Dependencies

To enable this parameter, set the **Source of output bus name** parameter to Property.

Simulate using — Type of simulation to run

Interpreted execution (default) | Code generation

- Interpreted execution — Simulate the model using the MATLAB interpreter. This option shortens startup time. In Interpreted execution mode, you can debug the source code of the block.
- Code generation — Simulate the model using generated C/C++ code. The first time you run a simulation, Simulink generates C/C++ code for the block. The C code is reused for subsequent simulations as long as the model does not change. This option requires additional startup time.

Extended Capabilities

C/C++ Code Generation

Generate C and C++ code using Simulink® Coder™.

See Also

Blocks

Global Nearest Neighbor Multi Object Tracker | Joint Probabilistic Data Association Multi Object Tracker | Track Concatenation | Track-Oriented Multi-Hypothesis Tracker | Track-To-Track Fuser

Topics

“Create Nonvirtual Buses” (Simulink)

Introduced in R2021a

Generalized Optimal Subpattern Assignment Metric

Calculate Generalized Optimal Subpattern Assignment Metric

Library: Sensor Fusion and Tracking Toolbox / Track Metrics

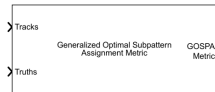

Description

The Generalized Optimal Subpattern Assignment Metric block evaluates the performance of a tracking algorithm by computing the generalized optimal subpattern assignment (GOSPA) metric between tracks and known truths. The metric is comprised of the switching error, localization error, missed target error, and false track error components. You can also select each individual error components as a block output.

Ports

Input

Tracks — Track list

Simulink bus containing MATLAB structure

Track list, specified as a Simulink bus containing a MATLAB structure.

If you specify the **Track bus** parameter on the **Port Setting** tab to objectTrack, the structure must use this form:

Field	Description
NumTracks	Number of tracks
Tracks	Array of track structures

Each track structure must contain **TrackID** and **State** fields. Additionally, if you specify an NEES-based distance (**posnees** or **velnees**) in the **Distance type** parameter, each structure must contain a **StateCovariance** field.

Field	Definition
TrackID	Unique track identifier used to distinguish multiple tracks, specified as a nonnegative integer.
State	Value of state vector at the update time, specified as an N -element vector, where N is the dimension of the state.

Field	Definition
StateCovariance	Uncertainty covariance matrix, specified as an N -by- N matrix, where N is the dimension of the state.

If you specify the **Track bus** parameter to `custom`, then you can use your own track bus format. In this case, you must define a track extractor function using the **Track extractor function** parameter. The function must use this syntax:

```
tracks = trackExtractorFcn(trackInputFromBus)
```

where `trackInputFromBus` is the input from the track bus and `tracks` must return as an array of structures with `TrackID` and `State` fields. If you specify an NEES-based distance (`posnees` or `velnees`) in the **Distance type** parameter, then the structure must contain a `StateCovariance` field.

Truths — Truth list

Simulink bus containing MATLAB structure

Truth list, specified as a Simulink bus containing a MATLAB structure.

If you specify the **Truth bus** parameter on the **Port Setting** tab to `Platform`, the structure must use this form:

Field	Description
NumPlatforms	Number of truth platforms
Platforms	Array of truth platform structures

Each platform structure has these fields:

Field	Definition
PlatformID	Unique identifier used to distinguish platforms, specified as a nonnegative integer.
Position	Position of the platform, specified as an M -element vector, where M is the dimension of the position state. For example, $M = 3$ for 3-D position.
Velocity	Velocity of the platform, specified as an M -element vector, where M is the dimension of the velocity state. For example, $M = 3$ for 3-D velocity.

If you specify the **Truth bus** parameter as `Actor`, the structure must use this form:

Field	Description
NumActors	Number of truth actors
Actors	Array of truth actor structures

Each actor structure has these fields:

Field	Definition
ActorID	Unique identifier used to distinguish actors, specified as a nonnegative integer.
Position	Position of the actor, specified as an M -element vector, where M is the dimension of the position state. For example, $M = 3$ for 3-D position.
Velocity	Velocity of the actor, specified as an M -element vector, where M is the dimension of the velocity state. For example, $M = 3$ for 3-D velocity.

If you specify the **Truth bus** parameter to `custom`, then you can define your own truth bus format. In this case, you must define a truth extractor function using the **Truth extractor function** parameter. The function must use this syntax:

```
truths = truthExtractorFcn(truthInputFromBus)
```

where `truthInputFromBus` is the input from the truth bus and `truths` must return as an array of structures with `PlatformID`, `Position`, and `Velocity` fields.

Assignments – Known assignment

K-by-2 matrix of nonnegative integers

Known assignment, specified as an K -by-2 matrix of nonnegative integers. K is the number of assignment pairs. The first column elements are track IDs, and the second column elements are truth IDs. The IDs in the same row are assigned to each other. If a track or truth is not assigned, specify 0 as the same row element.

The assignment must be a unique assignment between tracks and truths. Redundant or false tracks should be treated as unassigned tracks by assigning them to the "0" TruthID.

Dependencies

To enable this port, on the **Port Setting** tab, select **Assignments**.

Output

GOSPA Metric – GOSPA metric including switching error component

nonnegative real scalar

GOSPA metric including switching error component, returned as a nonnegative real scalar.

GOSPA Metric Without Switching – GOSPA metric without switching error component

nonnegative real scalar

GOSPA metric without switching error component, returned as a nonnegative real scalar.

Example: 8.5

Dependencies

To enable this port, on the **Port Setting** tab, select **GOSPA metric without switching error component**.

Switching Error – Switching error component

nonnegative real scalar

Switching error component, returned as a nonnegative real scalar.

Example: 8.5

Dependencies

To enable this port, on the **Port Setting** tab, select **Switching error**.

Localization Error – Localization error component

nonnegative real scalar

Localization error component, returned as a nonnegative real scalar.

Example: 8.5

Dependencies

To enable this port, on the **Port Setting** tab, select **Localization error**.

Missed Target Error – Missed target error component

nonnegative real scalar

Missed target error component, returned as a nonnegative real scalar.

Example: 8.5

Dependencies

To enable this port, on the **Port Setting** tab, select **Missed target error**.

False Track Error – False track error component

nonnegative real scalar

False track error component, returned as a nonnegative real scalar.

Example: 8.5

Dependencies

To enable this port, on the **Port Setting** tab, select **False track error**.

Parameters

Properties

Cutoff distance – Threshold for cutoff distance between track and truth

30 (default) | real positive scalar

Threshold for cutoff distance between track and truth, specified as a real positive scalar. If the computed distance between a track and the assigned truth is higher than the threshold, the actual distance incorporated in the metric is reduced to the threshold.

Example: 40

Order – Order of GOSPA metric

2 (default) | positive integer

Order of GOSPA metric, specified as a positive integer.

Example: 10

Alpha — Alpha parameter of GOSPA metric

2 (default) | positive scalar in range [0, 2]

Alpha parameter of the GOSPA metric, specified as a positive scalar in the range [0, 2].

Example: 1

Distance type — Distance type

posnees (default) | velnees | posabserr | velabserr

Distance type, specified as `posnees`, `velnees`, `posabserr`, or `velabserr`. The distance type specifies the physical quantity used for distance calculations:

- `posnees` - Normalized estimation error squared (NEES) of track position
- `velnees` - NEES error of track velocity
- `posabserr` - Absolute error of track position
- `velabserr` - Absolute error of track velocity
- `custom` - Custom distance error

If you specify it as `custom`, you must also specify the distance function in the **Custom distance function** parameter.

Custom distance function — Custom distance function

function handle

Custom distance function, specified as a function handle. The function must support the following syntax:

```
d = myCustomFcn(Track, Truth)
```

where `Track` is a structure for track information, `Truth` is a structure of truth information, and `d` is the distance between the truth and the track. See `objectTrack` for an example on how to organize track information.

Example: `@myCustomFcn`

Dependencies

To enable this property, set the **Distance type** parameter to `custom`.

Motion model — Desired platform motion model

constvel (default) | constacc | constturn | singer

Desired platform motion model, specified as `constvel`, `constacc`, `constturn`, or `singer`. This property selects the motion model used by the **Tracks** input port.

The motion models expect the `State` field of the track structure to have a column vector containing these values:

- `constvel` — Position is in elements [1 3 5], and velocity is in elements [2 4 6].
- `constacc` — Position is in elements [1 4 7], velocity is in elements [2 5 8], and acceleration is in elements [3 6 9].
- `constturn` — Position is in elements [1 3 6], velocity is in elements [2 4 7], and yaw rate is in element 5.

- `singer` — Position is in elements [1 4 7], velocity is in elements [2 5 8], and acceleration is in elements [3 6 9].

The `StateCovariance` field of the track structure input must have position, velocity, and turn-rate covariances in the rows and columns corresponding to the position, velocity, and turn rate of the `State` field of the track structure.

Switching penalty — Penalty for assignment switching

0 (default) | nonnegative real scalar

Penalty for assignment switching, specified as a nonnegative real scalar.

Example: 2

Simulate using — Type of simulation to run

Interpreted execution (default) | Code Generation

Select a simulation type from these options:

- `Interpreted execution` — Simulate the model using the MATLAB interpreter. This option shortens startup time. In `Interpreted execution` mode, you can debug the source code of the block.
- `Code generation` — Simulate the model using generated C code. The first time you run a simulation, Simulink generates C code for the block. The C code is reused for subsequent simulations as long as the model does not change. This option requires additional startup time.

Port Setting

Assignments — Enable assignment input

off (default) | on

Select this parameter to enable the input of known assignments through the **Assignments** input port.

GOSPA metric without switching error — Enable GOSPA metric without switching error output

off (default) | on

Select this parameter to enable the output of the GOSPA metric without the switching error component through the **GOSPA Metric Without Switching** output port.

Switching error — Enable switching error component output

off (default) | on

Select this parameter to enable the output of the switching error component through the **Switching Error** output port.

Localization error — Enable localization error component output

off (default) | on

Select this parameter to enable the output of the localization error component through the **Localization Error** output port.

Missed target error — Enable missed target error component output

off (default) | on

Select this parameter to enable the output of the missed target error component through the **Missed Target Error** output port.

False track error – Enable false track error component output

off (default) | on

Select this parameter to enable the output of the false track error component through the **False Track Error** output port.

Track bus – Track bus selection

objectTrack (default) | custom

Track bus selection, specified as `objectTrack` or `custom`. See the description of the **Tracks** input port for more details about each selection.

Truth bus – Truth bus selection

Platform (default) | Actor | custom

Truth bus selection, specified as `Platform`, `Actor`, or `custom`. See the description of the **Truths** input port for more details about each selection.

Track extractor function – Track extractor function

function handle

Track extractor function, specified as a function handle. The function must support this syntax:

```
tracks = trackExtractorFcn(trackInputFromBus)
```

where `trackInputFromBus` is the input from the track bus and `tracks` must return as an array of structures with `TrackID` and `State` fields. If you specify an NEES-based distance (`posnees` or `velnees`) in the **Distance type** parameter, then the structure must contain a `StateCovariance` field.

Example: `@myCustomFcn`

Dependencies

To enable this property, set the **Track bus** parameter to `custom`.

Truth extractor function – Truth extractor function

function handle

Truth extractor function, specified as a function handle. The function must support this syntax:

```
truths = truthExtractorFcn(truthInputFromBus)
```

where `truthInputFromBus` is the input from the track bus and `truths` must return as an array of structures with `PlatformID`, `Position`, and `Velocity` as field names.

Example: `@myCustomFcn`

Dependencies

To enable this property, set the **Truth bus** parameter to `custom`.

Algorithms

GOSPA Metric

At time t_k , a list of truths is:

$$X = [x_1, x_2, \dots, x_m]$$

At time t_k , a tracker obtains a list of tracks:

$$Y = [y_1, y_2, \dots, y_n]$$

In general, the GOSPA metric including the switching component (*SGOSPA*) is:

$$SGOSPA = \left(GOSPA^p + SC^p \right)^{1/p}$$

where p is the order of the metric, SC is the switching component, and *GOSPA* is the basic GOSPA metric.

Assuming $m \leq n$, *GOSPA* is:

$$GOSPA = \left[\sum_{i=0}^m d_c^p(x_i, y_{\Pi(i)}) + \frac{c^p}{\alpha}(n - m) \right]^{1/p}$$

where d_c is the cutoff-based distance and $y_{\Pi(i)}$ represents the track assigned to truth x_i . The cutoff-based distance d_c is defined as:

$$d_c(x, y) = \min\{d_b(x, y), c\}$$

where c is the cutoff distance threshold, and $d_b(x, y)$ is the base distance between track x and truth y calculated by the distance function. The cutoff based distance d_c is the smaller value of d_b and c . α is the alpha parameter.

The switching component SC is:

$$SC = SP \times n_s^{1/p}$$

where SP is the switching penalty and n_s is the number of switches. When a track switches assignment from one truth to another truth, the number of switching is counted as 1. When a track switches from assigned to unassigned or switches from unassigned to assigned, the number of switching is counted as 0.5. For example, as shown in the table, Tracks 1 and 2 both switched to different truths, whereas Track 3 switched from assigned to unassigned. Therefore, the total number of switching is 2.5.

Track Switching Scenario

Previous		Current	
Tracks	Truths	Tracks	Truths
1	3	1	7
2	5	2	3
3	7	3	0

When $\alpha = 2$, the GOSPA metric can reduce to three components:

$$GOSPA = [loc^p + miss^p + false^p]^{1/p}$$

The localization component (loc) is calculated as:

$$loc = \left[\sum_{i=1}^h d_b^p(x_i, y_{\Pi(i)}) \right]^{1/p}$$

where h is the number of nontrivial assignments. A trivial assignment is when a track is assigned to no truth. The missed target component is calculated as:

$$miss = \frac{c}{2^{1/p}} (n_{miss})^{1/p}$$

where n_{miss} is the number of missed targets. The false track component is calculated as:

$$false = \frac{c}{2^{1/p}} (n_{false})^{1/p}$$

where n_{false} is the number of false tracks.

If $m > n$, simply exchange m and n in the formulation to obtain the GOSPA metric.

Extended Capabilities

C/C++ Code Generation

Generate C and C++ code using Simulink® Coder™.

See Also

[Optimal Subpattern Assignment Metric](#) | [trackAssignmentMetrics](#) | [trackErrorMetrics](#) | [trackGOSPAMetric](#) | [trackOSPAMetric](#)

Introduced in R2021a

Probability Hypothesis Density (PHD) Tracker

Multi-sensor, multi-object PHD tracker

Library: Sensor Fusion and Tracking Toolbox / Multi-Object Tracking Algorithms

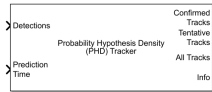

Description

The Probability Hypothesis Density (PHD) Tracker block creates and manages tracks of stationary and moving objects in a multi-sensor environment. The tracker uses a multi-target probability hypothesis density filter to estimate the states of point targets and extended objects. The PHD is represented by a weighted summation of probability density functions, and peaks in the PHD are extracted to represent possible targets. See “Algorithms” on page 4-39 for more details.

Ports

Input

Detections – Detection list

Simulink bus containing MATLAB structure

Detection list, specified as a Simulink bus containing a MATLAB structure. The structure has the form:

Field	Description	Type
NumDetections	Number of detections	Integer.
Detections	Object detections	Array of object detection structures. The first NumDetections of these detections are actual detections.

The fields of Detections are:

Field	Description	Type
Time	Measurement time	single or double
Measurement	Object measurements	single or double
MeasurementNoise	Measurement noise covariance matrix	single or double
SensorIndex	Unique ID of the sensor	single or double
ObjectClassID	Object classification ID	single or double
MeasurementParameters	Parameters used by initialization functions of tracking filters	Simulink Bus

Field	Description	Type
ObjectAttributes	Additional information passed to tracker	Simulink Bus

See `objectDetection` for more detailed explanations of these fields.

Note The object detection structure contains a `Time` field. The time tag of each object detection must be less than or equal to the time of the current invocation of the block. The time tag must also be greater than the update time specified in the previous invocation of the block.

Prediction Time – Track update time

real scalar

Track update time, specified as a real scalar in seconds. The tracker updates all tracks to this time. The update time must increase with each invocation of the block. Units are in seconds. The update time must be at least as large as the largest `Time` specified at the **Detections** input port.

If this port is not enabled, the simulation clock managed by Simulink determines the update time.

Dependencies

To enable this port, in the **Port Setting** tab, set **Prediction time source** to `Input port`.

Sensor Configurations – Configurations of tracking sensors

Simulink bus containing MATLAB structure

Configurations of tracking sensors, specified as a Simulink bus containing a MATLAB structure. The structure has the form:

Field	Description	Type
NumConfigurations	Number of sensor configurations	Integer.
Configurations	Sensor configurations	Array of sensor configuration structures. The first <code>NumConfigurations</code> of these configurations are actual configurations. The allowable field names and definitions are the same as the corresponding properties of the <code>trackingSensorConfiguration</code> object.

Dependencies

To enable this port, in the **Tracker** tab, select the **Update sensor configurations with time** parameter.

State Parameters – Track state parameters

Simulink bus containing MATLAB structure

Track state parameters, specified as a Simulink bus containing a MATLAB structure. The structure has the form:

Field	Description
NumParameters	Number of non-default state parameters, specified as a nonnegative integer
Parameters	Array of state parameter structures

The block uses the value of the `Parameters` field for the `StateParameters` field of the generated tracks. You can use these parameters to define the reference frame in which the track is reported or other desirable attributes of the generated tracks.

For example, you can use the following structure to define a rectangular reference frame whose origin position is at $[10 \ 10 \ 0]$ meters and whose origin velocity is $[2 \ -2 \ 0]$ meters per second with respect to the scenario frame.

Field Name	Value
Frame	"Rectangular"
Position	$[10 \ 10 \ 0]$
Velocity	$[2 \ -2 \ 0]$

Dependencies

To enable this port, in the **Tracker Configuration** tab, select the **Update track state parameters with time** parameter.

Output

Confirmed Tracks – Confirmed tracks

Simulink bus containing MATLAB structure

Confirmed tracks, returned as a Simulink bus containing a MATLAB structure. The structure has the form:

Field	Description
NumTracks	Number of tracks.
Tracks	Array of track structures of a length set by the Maximum number of tracks parameter. Only the first NumTracks of these are actual tracks.

The fields of the track structure are shown in “Track Structure” on page 4-41.

Tentative Tracks – Tentative tracks

Simulink bus containing MATLAB structure

Tentative tracks, returned as a Simulink bus containing a MATLAB structure. A track is tentative before it is confirmed. The output of this port has the same form as the output of the **Confirmed Tracks** port.

Dependencies

To enable this port, in the **Port Setting** tab, select **Enable tentative tracks output**.

All Tracks – Confirmed and Tentative tracks

Simulink bus containing MATLAB structure

Combined list of confirmed and tentative tracks, returned as a Simulink bus containing a MATLAB structure. The output of this port has the same form as the output of the **Confirmed Tracks** port.

Dependencies

To enable this port, in the **Port Setting** tab, select **Enable all tracks output**.

Info – Additional information for analyzing track updates

Simulink bus containing MATLAB structure

Additional information for analyzing track updates, returned as a Simulink bus containing a MATLAB structure.

This table shows the fields of the info structure:

Field	Description
CorrectionOrder	The order in which sensors are used for state estimate correction, returned as a row vector of <code>SensorIndex</code> values. For example, [1 3 2 4].
TrackIDsAtStepBeginning	Track IDs when the step began.
DeletedTrackIDs	IDs of tracks deleted during the step.
TrackIDsAtStepEnd	Track IDs when the step ended.
SensorAnalysisInfo	Cell array of sensor analysis information.

The `SensorAnalysisInfo` field can include multiple sensor information reports. Each report is a structure containing these fields:

Field	Description
SensorIndex	Sensor index.
DetectionCells	Detection cells, returned as a logical matrix. Each column of the matrix denotes a detection cell. In each column, if the i th element is 1, then the i th detection belongs to the detection cell denoted by that column.
DetectionLikelihoods	The association likelihoods between components in the density function and detection cells, returned as an N -by- P matrix. N is the number of components in the density function, and P is the number of detection cells.
IsBirthCells	Indicates if the detection cells listed in <code>DetectionCells</code> give birth to new tracks, returned as a 1-by- P logical vector, where P is the number of detection cells.
NumPartitions	Number of partitions.

DetectionProbability	Probability of existing tracks being detected by the sensor, returned as a 1-by- N row vector, where N is the number of components in the density function.
LabelsBeforeCorrection	Labels of components in the density function before correction, return as a 1-by- M_b row vector. M_b is the number of components maintained in the tracker before correction. Each element of the vector is a TrackID. For example, [1 1 2 0 0]. Note that multiple components can share the same TrackID.
LabelsAfterCorrection	Labels of components in the density function after correction, returned as a 1-by- M_a row vector. M_a is the number of components maintained in the tracker after correction. Each element of the vector is a TrackID. For example, [1 1 1 2 2 0 0]. Note that multiple components can share the same TrackID.
WeightsBeforeCorrection	Weights of components in the density function before correction, returned as a 1-by- M_b row vector. M_b is the number of components maintained in the tracker before correction. Each element of the vector is the weight of the corresponding component in LabelsBeforeCorrection. For example, [0.1 0.5 0.7 0.3 0.2].
WeightsAfterCorrection	Weights of components in the density function after correction, returned as a 1-by- M_a row vector. M_a is the number of components maintained in the tracker after correction. Each element of the vector is the weight of the corresponding component in LabelsAfterCorrection. For example, [0.1 0.4 0.2 0.6 0.3 0.2 0.2].

Dependencies

To enable this port, in the **Port Setting** tab, select **Enable information output**.

Parameters

Tracker Configuration

Tracker identifier – Unique tracker identifier

0 (default) | nonnegative integer

Unique tracker identifier, specified as a nonnegative integer. This parameter is passed as the **SourceIndex** in the tracker outputs, and distinguishes tracks that come from different trackers in a multiple-tracker system. You must specify this property as a positive integer to use the track outputs as inputs to a Track-To-Track Fuser block.

Example: 1

Detection partition function — Function to partition detections into detection cells`@partitionDetections (default) | function handle | character vector`

Function to partition detections into detection cells, specified as a function handle or as a character vector. When each sensor can report more than one detection per object, you must use a partition function. The partition function reports all possible partitions of the detections from a sensor. In each partition, the detections are separated into mutually exclusive detection cells, assuming that each detection cell belongs to one extended object.

You can also specify your own detections partition function. For guidance in writing this function, you can examine the details of the default partitioning function, `partitionDetections`, using the `type` command:

```
type partitionDetections
```

```
Example: @myfunction or 'myfunction'
```

Detection selection threshold — Threshold of selecting detections for component initialization`25 (default) | real positive scalar`

Threshold of selecting detections for component initialization, specified as a positive scalar. During correction, the tracker calculates the likelihood of association between existing tracks and detection cells. If the association likelihood (given by negative log-likelihood) of a detection cell to all existing tracks is higher than the threshold (which means the detection cell has low likelihood of association to existing tracks), the detection cell is used to initialize new components in the adaptive birth density.

```
Example: 18.1
```

```
Data Types: single | double
```

Maximum number of sensors — Maximum number of sensors`20 (default) | positive integer`

Maximum number of sensors that can be connected to the tracker, specified as a positive integer. `MaxNumSensors` must be greater than or equal to the largest value of `SensorIndex` found in all the detections used to update the block.

```
Data Types: single | double
```

Maximum number of tracks — Maximum number of tracks`1000 (default) | positive integer`

Maximum number of tracks that the tracker can maintain, specified as a positive integer.

```
Data Types: single | double
```

Sensor configurations — Configurations of tracking sensors`struct('SensorIndex',1,'IsValidTime',true) (default) | structure | structure array`

Configuration of tracking sensors, specified as a structure or an array of structures. This parameter provides the tracking sensor configuration information, such as sensor detection limits and sensor resolution, to the tracker. The allowable field names of each structure are the same as the property names of the `trackingSensorConfiguration` object. If you set the `MaxDetsPerObject` field of the structure to 1, the tracker creates only one partition, such that at most one detection can be assigned to each target.

You can update the configuration through the **Sensor configurations** input port by selecting the **Update sensor configurations with time** parameter.

Update sensor configurations with time — Update sensor configurations with time
off (default) | on

Select this parameter to enable the input port for tracking sensor configurations through the **Sensor Configurations** input port.

Track state parameters — Parameters of track state reference frame
structure | structure array

Parameters of the track state reference frame, specified as a structure or a structure array. The block passes the value of this parameter to the `StateParameters` field of the generated tracks. You can use these parameters to define the reference frame in which the track is reported or other desirable attributes of the generated tracks.

For example, you can use the following structure to define a rectangular reference frame whose origin position is at $[10\ 10\ 0]$ meters and whose origin velocity is $[2\ -2\ 0]$ meters per second with respect to the scenario frame.

Field Name	Value
Frame	"Rectangular"
Position	$[10\ 10\ 0]$
Velocity	$[2\ -2\ 0]$

You can update the track state parameters through the **State Parameters** input port by selecting the **Update track state parameters with time** parameter.

Data Types: struct

Update track state parameters with time — Update track state parameters with time
off (default) | on

Select this parameter to enable the input port for track state parameters through the **State Parameters** input port.

Simulate using — Type of simulation to run
Interpreted Execution (default) | Code Generation

Select the type of simulation to run from these options:

- **Interpreted execution** — Simulate the model using the MATLAB interpreter. This option shortens startup time. In the **Interpreted execution** mode, you can debug the source code of the block.
- **Code generation** — Simulate the model using generated C code. The first time you run a simulation, Simulink generates C code for the block. The C code is reused for subsequent simulations as long as the model does not change. This option requires additional startup time.

Track Management

Birth rate of new targets — Birth rate of new targets in the density
 $1e-3$ (default) | positive real scalar

Birth rate of new targets in the density, specified as a positive real scalar. Birth rate indicates the expected number of targets added in the density per unit time. The birth density is created by using the `FilterInitializationFcn` of the sensor configuration used with the tracker. In general, the tracker adds components to the density function in two ways:

- 1 Predictive birth density — This density is initialized by the `FilterInitializationFcn` function when called with no inputs.
- 2 Adaptive birth density — This density is initialized by the `FilterInitializationFcn` function when called with detection inputs. The tracker chooses detections based on their log-likelihood of association with the current estimates of the targets.

The value for the **Birth rate of new targets** parameter represents the summation of both predictive birth density and adaptive birth density for each time step.

Example: 0.01

Data Types: single | double

Death rate of components — Death rate of components in the density

1e-6 (default) | positive real scalar

Death rate of components in the density, specified as a positive real scalar. Death rate indicates the rate at which a component vanishes in the density after one time step. This equation illustrates how death rate (P_d) relates to the survival probability (P_s) of a component between successive time steps:

$$P_s = (1 - P_d)^{\Delta T}$$

where ΔT is the time step.

Example: 1e-4

Data Types: single | double

Threshold for initializing tentative tracks — Threshold for initializing tentative track

0.5 (default) | positive real scalar

Threshold for initializing a tentative track, specified as a positive real scalar. If the weight of a component is higher than the threshold, the component is labeled as a 'Tentative' track and given a `TrackID`.

Example: 0.45

Data Types: single | double

Threshold for track confirmation — Threshold for track confirmation

0.8 (default) | positive real scalar

Threshold for track confirmation, specified as a positive real scalar. In a PHD tracker, a track can have multiple components sharing the same `TrackID`. If the weight summation of the components of

a tentative track is higher than the confirmation threshold, the track status is marked as 'Confirmed'.

Example: 0.85

Data Types: single | double

Threshold for track deletion – Threshold for component deletion

1e-3 (default) | positive real scalar

Threshold for component deletion, specified as a positive real scalar. In the PHD tracker, if the weight of a component is lower than the deletion threshold, the component is deleted.

Example: 0.01

Data Types: single | double

Threshold for components merging – Threshold for components merging

25 (default) | positive real scalar

Threshold for components merging, specified as a positive real scalar. In the PHD tracker, if the Kullback-Leibler distance between components with the same TrackID is smaller than the merging threshold, then these components are merged into one component. The merged weight of the new component is equal to the summation of the weights of the pre-merged components. Moreover, if the merged weight is higher than the first threshold specified in the **Thresholds for label management** parameter, the merged weight is truncated to the first threshold. Note that components with a TrackID of 0 can also be merged with each other.

Example: 30

Data Types: single | double

Thresholds for label management – Thresholds for label management

[1.1 1 0.8] (default) | 1-by-3 vector of positive values

Labeling thresholds, specified as an 1-by-3 vector of decreasing positive values, $[C_1, C_2, C_3]$. Based on this parameter, the tracker manages components in the density using these rules:

- 1 The weight of any component that is higher than the first threshold C_1 is reduced to C_1 .
- 2 For all components with the same TrackID, if the largest weight among these components is greater than C_2 , then the component with the largest weight is preserved to retain the TrackID, while all other components are deleted.
- 3 For all components with the same TrackID, if the ratio of the largest weight to the weight summation of all these components is greater than C_3 , then the component with the largest weight is preserved to retain the TrackID, while all other components are deleted.
- 4 If neither condition 2 nor condition 3 is satisfied, then the component with the largest weight retains the TrackID, while the labels of all other components are set to 0. When this occurs, it means that some components may represent other objects. This process retains the possibility for these unreserved components to be extracted again in the future.

Port Setting

Prediction time source – Source of prediction time

Auto (default) | Input port

Source for prediction time, specified as **Input port** or **Auto**. Select **Input port** to input an update time by using the **Prediction Time** input port. Otherwise, the simulation clock managed by Simulink determines the update time.

Enable tentative tracks output — Enable output port for tentative tracks

off (default) | on

Select this parameter to enable the output of tentative tracks through the **Tentative Tracks** output port.

Enable all tracks output — Enable output port for all tracks

off (default) | on

Select this parameter to enable the output of all tracks through the **All Tracks** output port.

Enable information output — Enable output port for analysis information

off (default) | on

Select this parameter to enable the output of analysis information through the **Info** output port.

Source of output bus name — Source of output track bus name

Auto (default) | Property

Source of the output track bus name, specified as:

- **Auto** — The block automatically creates an output track bus name.
- **Property** — Specify the output track bus name by using the **Specify an output bus name** parameter.

Source of output info bus name — Source of output information bus name

Auto (default) | Property

Source of the output information bus name, specified as:

- **Auto** — The block automatically creates an output information bus name.
- **Property** — Specify the output information bus name by using the **Specify an output info bus name** parameter.

Dependencies

To enable this parameter, on the **Port Setting** tab, select **Enable information output**.

Algorithms

Tracker Logic Flow

The PHD tracker adopts an iterated-corrector approach to update the probability hypothesis density by processing detection information from multiple sensors sequentially. The workflow of the tracker follows these steps:

- 1 The tracker sorts sensors according to their detection reporting time and determines the order of correction accordingly.

- 2 The tracker considers two separate densities: current density and birth density. The current density is the density of targets propagated from the previous time step. The birth density is the density of targets expected to be born in the current time step.
- 3 For each sensor:
 - a The tracker predicts the current density to sensor time-stamp using the survival probability calculated from the death rate and the elapsed time from the last prediction.
 - b The tracker adds new components to the birth density using the `FilterInitializationFcn` with no inputs. This corresponds to the predictive birth density.
 - c The tracker creates partitions of the detections from the current sensor using the detection partitioning function. Each partition is a possible segmentation of detections into detection cells for each object. If the sensor configuration structure specifies the `MaxNumDetsPerObject` as 1, the tracker generates only one partition, in which each detection is a standalone cell.
 - d Each detection cell is evaluated against the current density, and a log-likelihood value is computed for each detection cell.
 - e Using the log-likelihood values, the tracker calculates the probability of each partition.
 - f The tracker corrects the current density using each detection cell.
 - g For detection cells with high negative log-likelihood (greater than the assignment threshold), the tracker adds new components to the birth density using the `FilterInitializationFcn` parameter. This corresponds to the adaptive birth density.
- 4 After correcting the current density with each sensor, the tracker adds the birth density to the current density. The tracker makes sure that the number of possible targets in the birth density is equal to $\text{BirthRate} \times dT$, where dT is the time step.
- 5 The current density is then predicted to the current update time.

Probability Hypothesis Density

Probability hypothesis density (PHD) is a function defined over the state-space of the tracking system, and its value at a state is defined as the expected number of targets per unit state-space volume. The PHD is usually approximated by a mixture of components, and each component corresponds to an estimate of the state. The commonly used approximations of PHD are Gaussian mixture, SMC mixture, GGIW mixture, and GIW mixture.

To understand PHD, take the Gaussian mixture as an example. The Gaussian mixture can be represented by

$$D(x) = \sum_{i=1}^M w_i N(x | m_i, P_i)$$

where M is the total number of components, $N(x|m_i, P_i)$ is a normal distribution with mean m_i and covariance P_i , and w_i is the weight of the i th component. The weight w_i denotes the number, which

can be fractional, of targets represented by the i th component. Integration of $D(x)$ over a state-space region results in the expected number of targets in that region. Integrating $D(x)$ over the whole state space results in the total expected number of targets ($\sum w_i$), since the integration of a normal distribution over the whole state space is 1. The x -coordinates of the peaks (local maximums) of $D(x)$ represent the most likely states of targets.

For example, the following figure illustrates a PHD function given by $D(x) = N(x|-4,2) + 0.5N(x|3,0.4) + 0.5N(x|4,0.4)$. The weight summation of these components is 2, which means that two targets probably exist. From the peaks of $D(x)$, the possible positions of these targets are at $x = -4$, $x = 3$, and $x = 4$. Notice that the last two components are very close to each other, which means that these two components can possibly be attributed to one object.

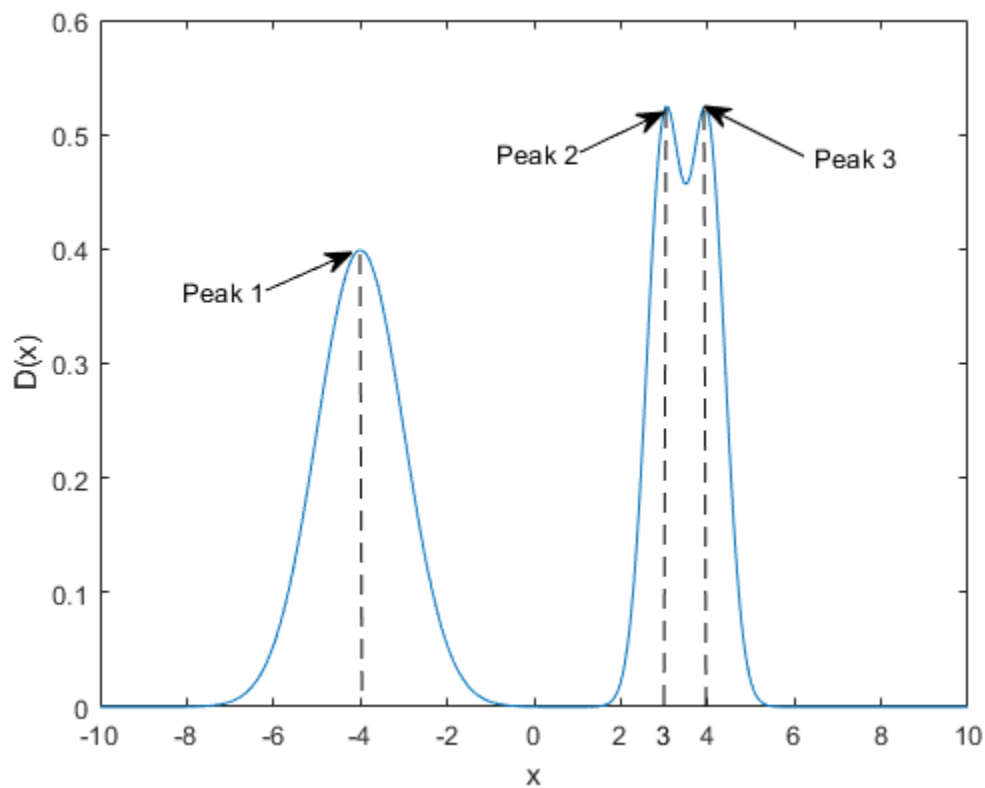

Track Structure

The fields of the track structure are:

Field	Definition
SourceIndex	Unique source index used to distinguish tracking sources in a multiple tracker environment.
TrackID	Unique track identifier used to distinguish multiple tracks.
BranchID	Unique track branch identifier used to distinguish multiple track branches.

Field	Definition
UpdateTime	Time at which the track is updated. Units are in seconds.
Age	Number of times the track survived.
State	Value of the state vector at the update time.
StateCovariance	Uncertainty covariance matrix.
TrackLogic	Confirmation and deletion logic type, returned as 'History' or 'Score'.
TrackLogicState	The current state of the track logic type. Based on the logic type <code>TrackLogic</code> , the logic state is returned as: <ul style="list-style-type: none"> 'History' — A 1-by-K logical array, where K is the number of latest track logical states recorded. In the array, 1 denotes hit and 0 denote miss. 'Score' — A 1-by-2 array of real scalars, [cs ms]. cs is the current score and ms is the maximum score.
IsConfirmed	Confirmation status. This field is <code>true</code> if the track is confirmed to be a real target.
IsCoasted	Coasting status. This field is <code>true</code> if the track is updated without a new detection.
IsSelfReported	Indicate if the track is reported by the tracker. This field is used in a track fusion environment. It is returned as <code>true</code> by default.
ObjectClassID	Integer value representing the object classification. The value 0 represents an unknown classification. Nonzero classifications apply only to confirmed tracks.
ObjectAttributes	Additional information of the track.

References

- [1] Granstorm, K., C. Lundquist, and O. Orguner. "Extended target tracking using a Gaussian-mixture PHD filter." *IEEE Transactions on Aerospace and Electronic Systems*. Vol. 48, Number 4, 2012, pp. 3268-3286.
- [2] Granstorm, K., and O. Orguner. "A PHD filter for tracking multiple extended targets using random matrices." *IEEE Transactions on Signal Processing*. Vol. 60, Number 11, 2012, pp. 5657-5671.
- [3] Granstorm, K., and A. Natale, P. Braca, G. Ludeno, and F. Serafino. "Gamma Gaussian inverse Wishart probability hypothesis density for extended target tracking using X-band marine radar data." *IEEE Transactions on Geoscience and Remote Sensing*. Vol. 53, Number 12, 2015, pp. 6617-6631.

Extended Capabilities

C/C++ Code Generation

Generate C and C++ code using Simulink® Coder™.

See Also

Objects

trackerPHD | trackingSensorConfiguration

Blocks

Global Nearest Neighbor Multi Object Tracker | Joint Probabilistic Data Association Multi Object Tracker | Track-Oriented Multi-Hypothesis Tracker | Track-To-Track Fuser

Topics

“Create Nonvirtual Buses” (Simulink)

Introduced in R2021a

Global Nearest Neighbor Multi Object Tracker

Multi-sensor, multi-object tracker using GNN assignment

Library: Sensor Fusion and Tracking Toolbox / Multi-Object Tracking Algorithms



Description

The Global Nearest Neighbor Multi Object Tracker block is capable of processing detections of many targets from multiple sensors, much like the `trackerGNN` System object. The tracker initializes, confirms, predicts, corrects, and deletes tracks based on a global nearest neighbor (GNN) assignment algorithm. The tracker estimates the state vector and state vector covariance matrix for each track. Each detection is assigned to at most one track. If the detection cannot be assigned to any track, the tracker initializes a new track.

Any new track starts in a tentative state. If enough detections are assigned to a tentative track, its status changes to confirmed. If the detection already has a known classification (the `ObjectClassID` field of the returned track is nonzero), that track is confirmed immediately. When a track is confirmed, the tracker considers the track to represent a physical object. If detections are not assigned to the track within a specifiable number of updates, the track is deleted.

Ports

Input

Detections — Detection list

Simulink bus containing MATLAB structure

Detection list, specified as a Simulink bus containing a MATLAB structure. The structure has the form:

Field	Description	Type
NumDetections	Number of detections	integer
Detections	Object detections	Array of object detection structures. The first NumDetections of these detections are actual detections.

The fields of Detections are:

Field	Description	Type
Time	Measurement time	single or double
Measurement	Object measurements	single or double

Field	Description	Type
MeasurementNoise	Measurement noise covariance matrix	single or double
SensorIndex	Unique ID of the sensor	single or double
ObjectClassID	Object classification ID	single or double
MeasurementParameters	Parameters used by initialization functions of tracking filters	Simulink Bus
ObjectAttributes	Additional information passed to tracker	Simulink Bus

See `objectDetection` for more detailed explanations of these fields.

Note The object detection structure contains a `Time` field. The time tag of each object detection must be less than or equal to the time of the current invocation of the block. The time tag must also be greater than the update time specified in the previous invocation of the block.

Prediction Time – Track update time

real scalar

Track update time, specified as a real scalar in seconds. The tracker updates all tracks to this time. The update time must always increase with each invocation of the block. Units are in seconds. The update time must be at least as large as the largest `Time` specified at the **Detections** input port.

If this port is not enabled, the simulation clock managed by Simulink determines the update time.

Dependencies

To enable this port, in the **Port Setting** tab, set **Prediction time source** to `Input` port.

Cost Matrix – Cost matrix

real-valued N_t -by- N_d matrix

Cost matrix, specified as a real-valued N_t -by- N_d matrix, where N_t is the number of existing tracks and N_d is the number of current detections.

The rows of the cost matrix correspond to the existing tracks. The columns correspond to the detections. Tracks are ordered as they appear in the list of tracks at the **All Tracks** output port on the previous invocation of the block.

In the first update to the tracker, or if the track has no previous tracks, assign the cost matrix a size of $[0, N_d]$. The cost must be calculated so that lower costs indicate a higher likelihood that the tracker assigns a detection to a track. To prevent certain detections from being assigned to certain tracks, use `Inf`.

If this port is not enabled, the filter initialized by the **Filter initialization function** calculates the cost matrix using the distance method.

Dependencies

To enable this port, in the **Port Setting** tab, select **Enable cost matrix input**.

Detectable TrackIDs – Detectable track IDsreal-valued M -by-1 vector | real-valued M -by-2 matrix

Detectable track IDs, specified as a real-valued M -by-1 vector or M -by-2 matrix. Detectable tracks are tracks that the sensors expect to detect. The first column of the matrix contains a list of track IDs that the sensors report as detectable. The second column contains the detection probability for the track. The detection probability is either reported by a sensor or, if not reported, obtained from the **Probability of detection used for track score** parameter.

Tracks whose identifiers are not included in **Detectable TrackIDs** are considered undetectable. The track deletion logic does not count the lack of detection as a "missed detection" for track deletion purposes.

If this port is not enabled, the tracker assumes all tracks to be detectable at each invocation of the block.

Dependencies

To enable this port, in the **Port Setting** tab, select **Enable detectable track IDs Input**.

State Parameters – Track state parameters

Simulink bus containing MATLAB structure

Track state parameters, specified as a Simulink bus containing a MATLAB structure. The structure has the form:

Field	Description
NumParameters	Number of non-default state parameters, specified as a nonnegative integer
Parameters	Array of state parameter structures

The block uses the value of the `Parameters` field for the `StateParameters` field of the generated tracks. You can use these parameters to define the reference frame in which the track is reported or other desirable attributes of the generated tracks.

For example, you can use the following structure to define a rectangular reference frame whose origin position is at $[10 \ 10 \ 0]$ meters and whose origin velocity is $[2 \ -2 \ 0]$ meters per second with respect to the scenario frame.

Field Name	Value
Frame	"Rectangular"
Position	$[10 \ 10 \ 0]$
Velocity	$[2 \ -2 \ 0]$

Dependencies

To enable this port, in the **Tracker Configuration** tab, select the **Update track state parameters with time** parameter.

Output**Confirmed Tracks – Confirmed tracks**

Simulink bus containing MATLAB structure

Confirmed tracks, returned as a Simulink bus containing a MATLAB structure. The structure has the form:

Field	Description
NumTracks	Number of tracks
Tracks	Array of track structures of a length set by the Maximum number of tracks parameter. Only the first NumTracks of these are actual tracks.

The fields of the track structure are shown in “Track Structure” on page 4-55.

Depending on the track logic, a track is confirmed if:

- History - A track receives at least M detections in the last N updates. M and N are specified in **Confirmation threshold** for the History logic.
- Score - The track score is at least as high as the confirmation threshold specified in **Confirmation threshold** for the Score logic.

Tentative Tracks – Tentative tracks

Simulink bus containing MATLAB structure

Tentative tracks, returned as a Simulink bus containing a MATLAB structure. A track is tentative before it is confirmed.

The fields of the track structure are shown in “Track Structure” on page 4-55.

Dependencies

To enable this port, in the **Port Setting** tab, select **Enable tentative tracks output**.

All Tracks – Confirmed and Tentative tracks

Simulink bus containing MATLAB structure

Combined list of confirmed and tentative tracks, returned as a Simulink bus containing a MATLAB structure.

The fields of the track structure are shown in “Track Structure” on page 4-55.

Dependencies

To enable this port, in the **Port Setting** tab, select **Enable all tracks output**.

Info – Additional information for analyzing track updates

Simulink bus containing MATLAB structure

Additional information for analyzing track updates, returned as a Simulink bus containing a MATLAB structure.

This table shows the fields of the info structure:

Field	Description
TrackIDsAtStepBeginning	Track IDs when step began
CostMatrix	Cost of assignment matrix

Assignments	Assignments returned from the assignment function
UnassignedTracks	IDs of unassigned tracks returned from the tracker
UnassignedDetections	IDs of unassigned detections returned from the tracker
InitiatedTrackIDs	IDs of tracks initiated during the step
DeletedTrackIDs	IDs of tracks deleted during the step
TrackIDsAtStepEnd	Track IDs when the step ended

Dependencies

To enable this port, in the **Port Setting** tab, select **Enable information output**.

Parameters

Tracker Management

Filter initialization function – Filter initialization function

@initcvckf (default) | function handle | character vector

Filter initialization function, specified as a function handle or as a character vector containing the name of a valid filter initialization function. The tracker uses the filter initialization function when creating new tracks.

Sensor Fusion and Tracking Toolbox supplies many initialization functions that you can use:

Initialization Function	Function Definition
initcvabf	Initialize constant-velocity alpha-beta filter
initcaabf	Initialize constant-acceleration alpha-beta filter
initcvekf	Initialize constant-velocity extended Kalman filter.
initcackf	Initialize constant-acceleration cubature filter.
initctckf	Initialize constant-turn-rate cubature filter.
initcvckf	Initialize constant-velocity cubature filter.
initcapf	Initialize constant-acceleration particle filter.
initctpf	Initialize constant-turn-rate particle filter.
initcvpf	Initialize constant-velocity particle filter.
initcvkf	Initialize constant-velocity linear Kalman filter.
initcvukf	Initialize constant-velocity unscented Kalman filter.
initcaekf	Initialize constant-acceleration extended Kalman filter.
initcakf	Initialize constant-acceleration linear Kalman filter.

Initialization Function	Function Definition
<code>initcaukf</code>	Initialize constant-acceleration unscented Kalman filter.
<code>initctekf</code>	Initialize constant-turn-rate extended Kalman filter.
<code>initctukf</code>	Initialize constant-turn-rate unscented Kalman filter.
<code>initcvmscekf</code>	Initialize constant-velocity modified spherical coordinates extended Kalman filter.
<code>initrpekf</code>	Initialize constant-velocity range-parametrized extended Kalman filter.
<code>initapekf</code>	Initialize constant-velocity angle-parametrized extended Kalman filter.
<code>initekfimm</code>	Initialize tracking IMM filter.

You can also write your own initialization function. The function must have this syntax:

```
filter = filterInitializationFcn(detection)
```

The input to this function is a detection report like those created by `objectDetection`. The output of this function must be a filter object: `trackingKF`, `trackingEKF`, `trackingUKF`, `trackingCKF`, `trackingPF`, `trackingMSCEKF`, `trackingGSF`, `trackingIMM`, or `trackingABF`.

To guide you in writing this function, you can examine the details of the supplied functions from within MATLAB. For example:

```
type initcvekf
```

Assignment algorithm name — Assignment algorithm name

'MatchPairs' (default) | 'Munkres' | 'Jonker-Volgenant' | 'Auction' | 'Custom'

Assignment algorithm, specified as 'MatchPairs', 'Munkres', 'Jonker-Volgenant', 'Auction', or 'Custom'. Munkres is the only assignment algorithm that guarantees an optimal solution, but it is also the slowest, especially for large numbers of detections and tracks. The other algorithms do not guarantee an optimal solution but can be faster for problems with 20 or more tracks and detections. Use 'Custom' to define your own assignment function and specify its name in the `CustomAssignmentFcn` property.

Name of 'Custom' assignment function — Custom assignment function name

character vector

Custom assignment function name, specified as a character string. An assignment function must have this syntax:

```
[assignment,unTrs,unDets] = f(cost,costNonAssignment)
```

For an example of an assignment function and a description of its arguments, see `assignmunkres`.

Example: 'mycustomfcn'

Dependencies

To enable this property, set the **Assignment algorithm name** name to 'Custom'.

Threshold for assigning detections to tracks – Threshold for assigning detections to tracks

30*[1 Inf] (default) | positive scalar | 1-by-2 vector of positive values

Threshold for assigning detections to tracks (or gating threshold), specified as a positive scalar or an 1-by-2 vector of $[C_1, C_2]$, where $C_1 \leq C_2$. If specified as a scalar, the specified value, *val*, will be expanded to $[val, Inf]$.

Initially, the tracker executes a coarse estimation for the normalized distance between all the tracks and detections. The tracker only calculates the accurate normalized distance for the combinations whose coarse normalized distance is less than C_2 . Also, the tracker can only assign a detection to a track if their accurate normalized distance is less than C_1 . See the `distance` function used with tracking filters (for example, `trackingCKF` and `trackingEKF`) for an explanation of the distance calculation.

Tips:

- Increase the value of C_2 if there are combinations of track and detection that should be calculated for assignment but are not. Decrease it if cost calculation takes too much time.
- Increase the value of C_1 if there are detections that should be assigned to tracks but are not. Decrease it if there are detections that are assigned to tracks they should not be assigned to (too far away).

Maximum number of tracks – Maximum number of tracks

200 (default) | positive integer

Maximum number of tracks that the block can maintain, specified as a positive integer.

Maximum number of sensors – Maximum number of sensors

20 (default) | positive integer

Maximum number of sensors that the block can process, specified as a positive integer. This value should be greater than or equal to the highest `SensorIndex` value input at the **Detections** input port.

Out-of-sequence measurements handling – Out-of-sequence measurements handling

Terminate (default) | neglect

Out-of-sequence measurements handling, specified as `Terminate` or `neglect`. Each detection has a timestamp associated with it, t_d , and the tracker block has its own timestamp, t_t , which is updated in each invocation. The tracker block considers a measurement as an OOSM if $t_d < t_t$.

When the parameter is specified as:

- `Terminate` — The block stops running when it encounters any out-of-sequence measurements.
- `Neglect` — The block neglects any out-of-sequence measurements and continues to run.

Track state parameters – Parameters of track state reference frame

structure | structure array

Parameters of the track state reference frame, specified as a structure or a structure array. The block passes the value of this parameter to the `StateParameters` field of the generated tracks. You can use these parameters to define the reference frame in which the track is reported or other desirable attributes of the generated tracks.

For example, you can use the following structure to define a rectangular reference frame whose origin position is at [10 10 0] meters and whose origin velocity is [2 -2 0] meters per second with respect to the scenario frame.

Field Name	Value
Frame	"Rectangular"
Position	[10 10 0]
Velocity	[2 -2 0]

You can update the track state parameters through the **State Parameters** input port by selecting the **Update track state parameters with time** parameter.

Data Types: struct

Update track state parameters with time – Update track state parameters with time
off (default) | on

Select this parameter to enable the input port for track state parameters through the **State Parameters** input port.

Simulate using – Type of simulation to run
Interpreted Execution (default) | Code Generation

- **Interpreted execution** – Simulate the model using the MATLAB interpreter. This option shortens startup time. In **Interpreted execution** mode, you can debug the source code of the block.
- **Code generation** – Simulate the model using generated C code. The first time you run a simulation, Simulink generates C code for the block. The C code is reused for subsequent simulations as long as the model does not change. This option requires additional startup time.

Track Logic

Type of track confirmation and deletion logic – Confirmation and deletion logic type
History (default) | Score

Confirmation and deletion logic type, selected as **History** or **Score**.

- **History** - Track confirmation and deletion is based on the number of times the track has been assigned to a detection in the latest tracker updates.
- **Score** - Track confirmation and deletion is based on a log-likelihood track score. A high score means that the track is more likely to be valid. A low score means that the track is more likely to be a false alarm.

Confirmation threshold [M N] – Track confirmation threshold for history logic
[2 3] (default) | real-valued 1-by-2 vector of positive integers

Track confirmation threshold for history logic, specified as a real-valued 1-by-2 vector of positive integers [M N]. A track is confirmed if it receives at least M detections in the last N updates.

Dependencies

To enable this parameter, set **Type of track confirmation and deletion logic** to **History**.

Deletion threshold [P Q] — Track deletion threshold for history logic

[5 5] (default) | real-valued 1-by-2 vector of positive integers

Track deletion threshold for history logic, specified as a real-valued 1-by-2 vector of positive integers [P Q]. If a confirmed track is not assigned to any detection P times in the last Q tracker updates, then the track is deleted.

Dependencies

To enable this parameter, set **Type of track confirmation and deletion logic** to History.

Confirmation threshold [positive scalar] — Track confirmation threshold for score logic

20 (default) | positive scalar

Track confirmation threshold for score logic, specified as a real-valued positive scalar. A track is confirmed if its score is at least as high as the confirmation threshold.

Dependencies

To enable this parameter, set **Type of track confirmation and deletion logic** to Score.

Deletion threshold [negative scalar] — Track deletion threshold for score logic

-7 (default) | scalar | negative scalar

Track deletion threshold for score logic, specified as a negative scalar. A track is deleted if its score decreases by at least the threshold from the maximum track score.

Dependencies

To enable this parameter, set **Type of track confirmation and deletion logic** to Score.

Probability of detection used for track score — Probability of detection used for track score

0.9 (default) | scalar in (0,1)

Probability of detection used for track score, specified as a positive scalar in (0,1).

Example: 0.5

Dependencies

To enable this parameter, set **Type of track confirmation and deletion logic** to Score.

Rate of false positives used for track score — Probability of false alarm used for track score

1e-6 (default) | scalar in (0,1)

The probability of false alarm used for track score, specified as a scalar in (0,1).

Example: 1e-5

Dependencies

To enable this parameter, set **Type of track confirmation and deletion logic** to Score.

Volume of the sensor's detection bin — Volume of sensor detection bin

1 (default) | positive scalar

The volume of a sensor detection bin, specified as a positive scalar. For example, if a radar produces a 4-D measurement, which includes azimuth, elevation, range, and range rate, the 4-D volume is defined by the radar angular beam width, the range bin width, and the range-rate bin width. Volume is used in calculating the track score when initializing and updating a track.

Example: 1.5

Dependencies

To enable this parameter, set **Type of track confirmation and deletion logic** to Score.

Rate of new tracks per unit volume — Rate of new tracks per unit volume

1 (default) | positive scalar

The rate of new tracks per unit volume, specified as a positive scalar. The rate of new tracks is used in calculating the track score during track initialization.

Example: 2.5

Dependencies

To enable this parameter, set **Type of track confirmation and deletion logic** to Score.

Port Setting

Prediction time source — Source of prediction time

Auto (default) | Input port

Source for prediction time, specified as Input port or Auto. Select Input port to input an update time by using the **Prediction Time** input port. Otherwise, the simulation clock managed by Simulink determines the update time.

Enable cost matrix input — Enable input port for cost matrix

off (default) | on

Select this check box to enable the input of a cost matrix by using the **Cost Matrix** input port.

Enable detectable track IDs input — Enable detectable track IDs input

off (default) | on

Select this check box to enable the **Detectable track IDs** input port.

Enable tentative tracks output — Enable output port for tentative tracks

off (default) | on

Select this check box to enable the output of tentative tracks through the **Tentative Tracks** output port.

Enable all tracks output — Enable output port for all tracks

off (default) | on

Select this check box to enable the output of all the tracks through the **All Tracks** output port.

Enable information output — Enable output port for analysis information

off (default) | on

Select this check box to enable the output port for analysis information through the **Info** output port.

Source of output bus name — Source of output track bus name

Auto (default) | Property

Source of the output track bus name, specified as:

- Auto — The block automatically creates an output track bus name.
- Property — Specify the output track bus name by using the **Specify an output bus name** parameter.

Source of output info bus name — Source of output info bus name

Auto (default) | Property

Source of the output info bus name, specified as one of these options:

- Auto — The block automatically creates an output info bus name.
- Property — Specify the output info bus name by using the **Specify an output bus name** parameter.

Algorithms

Tracker Logic Flow

When a GNN tracker processes detections, track creation and management follow these steps:

- 1 The tracker divides detections by originating sensor.
- 2 For each sensor:
 - a The tracker calculates the distances from detections to existing tracks and forms a cost matrix.
 - b Based on the costs, the tracker performs global nearest neighbor assignment using the algorithm specified by the **Assignment algorithm name** parameter.
 - c The assignment algorithm divides the detections and tracks into three groups:
 - Assigned one-to-one detection and track pairs
 - Unassigned detections
 - Unassigned tracks
- 3 Unassigned detections initialize new tracks. Using the unassigned detection, the tracker initializes a new track filter specified by the **Filter initialization function** parameter. The track logic for the new track is initialized as well.

The tracker checks if any of the unassigned detections from other sensors can be assigned to the new track. If so, the tracker updates the new track with the assigned detections from the other sensors. As a result, these detections no longer initialize new tracks.

- 4 The pairs of assigned tracks and detections are used to update each track. The track filter is updated using the correct method provided by the specified tracking filter. Also, the track logic is updated with a "hit". The tracker checks if the track meets the criteria for confirmation. If so, the tracker confirms the track and sets the `IsCoasted` field to `false`.
- 5 Unassigned tracks are updated with a "miss" and their `IsCoasted` field is set to `true`. The tracker checks if the track meets the criteria for deletion. If so, the tracker removes the track from the maintained track list.

- 6 All tracks are predicted to the latest time value (either the time provided by the **Prediction Time** input port, or the time determined by Simulink).

Track Structure

The fields of the track structure are:

Field	Definition
TrackID	Unique track identifier used to distinguish multiple tracks.
BranchID	Unique track branch identifier used to distinguish multiple track branches.
SourceIndex	Unique source index used to distinguish tracking sources in a multiple tracker environment.
UpdateTime	Time at which the track is updated. Units are in seconds.
Age	Number of times the track survived.
State	Value of state vector at the update time.
StateCovariance	Uncertainty covariance matrix.
ObjectClassID	Integer value representing the object classification. The value 0 represents an unknown classification. Nonzero classifications apply only to confirmed tracks.
TrackLogic	Confirmation and deletion logic type, returned as 'History' or 'Score'.
TrackLogicState	The current state of the track logic type. Based on the logic type <code>TrackLogic</code> , the logic state is returned as: <ul style="list-style-type: none"> 'History' - A 1-by-K logical array, where K is the number of latest track logical states recorded. In the array, 1 denotes hit and 0 denote miss. 'Score' - A 1-by-2 array of real scalars, [cs, ms]. cs is the current score, and ms is the maximum score.
IsConfirmed	Confirmation status. This field is <code>true</code> if the track is confirmed to be a real target.
IsCoasted	Coasting status. This field is <code>true</code> if the track is updated without a new detection.
IsSelfReported	Indicate if the track is reported by the tracker. This field is used in a track fusion environment. It is returned as <code>true</code> by default.
ObjectAttributes	Additional information of the track.

Extended Capabilities

C/C++ Code Generation

Generate C and C++ code using Simulink® Coder™.

See Also

Blocks

Joint Probabilistic Data Association Multi Object Tracker

Functions

assignauction | assignjv | assignkbest | assignkbestsd | assignmunkres | assignsd | fusecovint | fusecovunion | fusexcov | getTrackPositions | getTrackVelocities

Objects

objectDetection | objectTrack | trackHistoryLogic | trackScoreLogic | trackerGNN | trackerJPDA | trackerTOMHT | trackingABF | trackingCKF | trackingEKF | trackingGSF | trackingIMM | trackingKF | trackingMSCEKF | trackingPF | trackingUKF

Blocks

Joint Probabilistic Data Association Multi Object Tracker | Track-Oriented Multi-Hypothesis Tracker | Track-To-Track Fuser

Topics

“Introduction to Multiple Target Tracking”

“Introduction to Assignment Methods in Tracking Systems”

“Create Nonvirtual Buses” (Simulink)

Introduced in R2019b

IMU

IMU simulation model

Library: Sensor Fusion and Tracking Toolbox / Multisensor Positioning / Sensor Models
Navigation Toolbox / Multisensor Positioning / Sensor Models

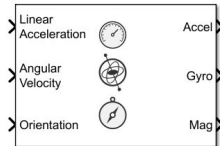

Description

The IMU Simulink block models receiving data from an inertial measurement unit (IMU) composed of accelerometer, gyroscope, and magnetometer sensors.

Ports

Input

Linear Acceleration — Acceleration of IMU in local navigation coordinate system (m/s²)

N-by-3 matrix of real scalar

Acceleration of the IMU in the local navigation coordinate system, specified as an *N*-by-3 matrix of real scalars in meters per second squared. *N* is the number of samples in the current frame.

Data Types: single | double

Angular Velocity — Angular velocity of IMU in local navigation coordinate system (rad/s)

N-by-3 matrix of real scalar

Angular velocity of the IMU sensor body frame in the local navigation coordinate system, specified as an *N*-by-3 matrix of scalars in radians per second. *N* is the number of samples in the current frame.

Data Types: single | double

Orientation — Orientation of IMU in local navigation coordinate system

N-by-4 array of real scalar | 3-by-3-by-*N*-element rotation matrix

Orientation of the IMU sensor body frame with respect to the local navigation coordinate system, specified as an *N*-by-4 array of real scalars or a 3-by-3-by-*N* rotation matrix. Each row the of the *N*-by-4 array is assumed to be the four elements of a quaternion. *N* is the number of samples in the current frame.

Data Types: single | double

Output

Accel — Accelerometer measurement of IMU in sensor body coordinate system (m/s²)

N-by-3 matrix of real scalar

Accelerometer measurement of the IMU in the sensor body coordinate system, returned as an N -by-3 matrix of real scalars in meters per second squared. N is the number of samples in the current frame.

Data Types: `single` | `double`

Gyro — Gyroscope measurement of IMU in sensor body coordinate system (rad/s)

N -by-3 matrix of real scalar

Gyroscope measurement of the IMU in the sensor body coordinate system, returned as an N -by-3 matrix of real scalars in radians per second. N is the number of samples in the current frame.

Data Types: `single` | `double`

Mag — Magnetometer measurement of IMU in sensor body coordinate system (μT)

N -by-3 matrix of real scalar

Magnetometer measurement of the IMU in the sensor body coordinate system, returned as an N -by-3 matrix of real scalars in microtesla. N is the number of samples in the current frame.

Data Types: `single` | `double`

Parameters

Parameters

Reference frame — Navigation reference frame

`NED` (default) | `ENU`

Navigation reference frame, specified as `NED` (North-East-Down) or `ENU` (East-North-Up).

Temperature ($^{\circ}\text{C}$) — Operating temperature of IMU ($^{\circ}\text{C}$)

`25` (default) | real scalar

Operating temperature of the IMU in degrees Celsius, specified as a real scalar.

When the block calculates temperature scale factors and environmental drift noises, 25°C is used as the nominal temperature.

Data Types: `single` | `double`

Magnetic field (NED) — Magnetic field vector expressed in NED navigation frame (μT)

`[27.5550, -2.4169, -16.0849]` (default) | 1-by-3 vector of scalar

Magnetic field vector expressed in the `NED` navigation frame, specified as a 1-by-3 vector of scalars.

The default magnetic field corresponds to the magnetic field at latitude zero, longitude zero, and altitude zero.

Dependencies

To enable this parameter, set **Reference frame** to `NED`.

Data Types: `single` | `double`

MagneticField (ENU) — Magnetic field vector expressed in ENU navigation frame (μT)

`[-2.4169, 27.5550, 16.0849]` (default) | 1-by-3 vector of scalar

Magnetic field vector expressed in the `ENU` navigation frame, specified as a 1-by-3 vector of scalars.

The default magnetic field corresponds to the magnetic field at latitude zero, longitude zero, and altitude zero.

Dependencies

To enable this parameter, set **Reference frame** to ENU.

Data Types: `single` | `double`

Seed — Initial seed for randomization

67 (default) | nonnegative integer

Initial seed of a random number generator algorithm, specified as a nonnegative integer.

Data Types: `single` | `double`

Simulate using — Type of simulation to run

Interpreted Execution (default) | Code Generation

- **Interpreted execution** — Simulate the model using the MATLAB interpreter. This option shortens startup time. In Interpreted execution mode, you can debug the source code of the block.
- **Code generation** — Simulate the model using generated C code. The first time that you run a simulation, Simulink generates C code for the block. The C code is reused for subsequent simulations if the model does not change. This option requires additional startup time.

Accelerometer

Maximum readings (m/s²) — Maximum sensor reading (m/s²)

`inf` (default) | real positive scalar

Maximum sensor reading in m/s², specified as a real positive scalar.

Data Types: `single` | `double`

Resolution ((m/s²)/LSB) — Resolution of sensor measurements ((m/s²)/LSB)

0 (default) | real nonnegative scalar

Resolution of sensor measurements in (m/s²)/LSB, specified as a real nonnegative scalar.

Data Types: `single` | `double`

Constant offset bias (m/s²) — Constant sensor offset bias (m/s²)

[0 0 0] (default) | real scalar | real 3-element row vector

Constant sensor offset bias in m/s², specified as a real scalar or 3-element row vector. Any scalar input is converted into a real 3-element row vector where each element has the input scalar value.

Data Types: `single` | `double`

Axis skew (%) — Sensor axes skew (%)

[0 0 0] (default) | real scalar in the range [0,100] | real 3-element row vector in the range [0,100]

Sensor axes skew in a percentage, specified as a real scalar or 3-element row vector with values ranging from 0 to 100. Any scalar input is converted into a real 3-element row vector where each element has the input scalar value.

Data Types: `single` | `double`

Velocity random walk (m/s²/√Hz) — Velocity random walk (m/s²/√Hz)

[0 0 0] (default) | real scalar | real 3-element row vector

Velocity random walk in (m/s²/√Hz), specified as a real scalar or 3-element row vector. This property corresponds to the power spectral density of sensor noise. Any scalar input is converted into a real 3-element row vector where each element has the input scalar value.

Data Types: single | double

Bias Instability (m/s²) — Instability of the bias offset (m/s²)

[0 0 0] (default) | real scalar | real 3-element row vector

Instability of the bias offset in m/s², specified as a real scalar or 3-element row vector. Any scalar input is converted into a real 3-element row vector where each element has the input scalar value.

Data Types: single | double

Acceleration random walk ((m/s²)(√Hz)) — Acceleration random walk ((m/s²)(√Hz))

[0 0 0] (default) | real scalar | real 3-element row vector

Acceleration random walk of sensor in (m/s²)(√Hz), specified as a real scalar or 3-element row vector. Any scalar input is converted into a real 3-element row vector where each element has the input scalar value.

Data Types: single | double

Bias from temperature ((m/s²)/°C) — Sensor bias from temperature ((m/s²)/°C)

[0 0 0] (default) | real scalar | real 3-element row vector

Sensor bias from temperature in (m/s²)/°C, specified as a real scalar or 3-element row vector. Any scalar input is converted into a real 3-element row vector where each element has the input scalar value.

Data Types: single | double

Temperature scale factor (%/°C) — Scale factor error from temperature (%/°C)

[0 0 0] (default) | real scalar in the range [0,100] | real 3-element row vector in the range [0,100]

Scale factor error from temperature in %/°C, specified as a real scalar or real 3-element row vector with values ranging from 0 to 100. Any scalar input is converted into a real 3-element row vector where each element has the input scalar value.

Data Types: single | double

Gyroscope**Maximum readings (rad/s) — Maximum sensor reading (rad/s)**

inf (default) | real positive scalar

Maximum sensor reading in rad/s, specified as a real positive scalar.

Data Types: single | double

Resolution ((rad/s)/LSB) — Resolution of sensor measurements ((rad/s)/LSB)

0 (default) | real nonnegative scalar

Resolution of sensor measurements in (rad/s)/LSB, specified as a real nonnegative scalar.

Data Types: single | double

Constant offset bias (rad/s) — Constant sensor offset bias (rad/s)

[0 0 0] (default) | real scalar | real 3-element row vector

Constant sensor offset bias in rad/s, specified as a real scalar or 3-element row vector. Any scalar input is converted into a real 3-element row vector where each element has the input scalar value.

Data Types: single | double

Axis skew (%) — Sensor axes skew (%)

[0 0 0] (default) | real scalar in the range [0,100] | real 3-element row vector in the range [0,100]

Sensor axes skew in a percentage, specified as a real scalar or 3-element row vector with values ranging from 0 to 100. Any scalar input is converted into a real 3-element row vector where each element has the input scalar value.

Data Types: single | double

Bias from acceleration ((rad/s)/(m/s²) — Sensor bias from linear acceleration (rad/s)/(m/s²)

[0 0 0] (default) | real scalar | real 3-element row vector

Sensor bias from linear acceleration in (rad/s)/(m/s²), specified as a real scalar or 3-element row vector. Any scalar input is converted into a real 3-element row vector where each element has the input scalar value.

Data Types: single | double

Angle random walk ((rad/s)/(√Hz)) — Acceleration random walk ((rad/s)/(√Hz))

[0 0 0] (default) | real scalar | real 3-element row vector

Acceleration random walk of sensor in (rad/s)/(√Hz), specified as a real scalar or 3-element row vector. Any scalar input is converted into a real 3-element row vector where each element has the input scalar value.

Data Types: single | double

Bias Instability (rad/s) — Instability of the bias offset (rad/s)

[0 0 0] (default) | real scalar | real 3-element row vector

Instability of the bias offset in rad/s, specified as a real scalar or 3-element row vector. Any scalar input is converted into a real 3-element row vector where each element has the input scalar value.

Data Types: single | double

Rate random walk ((rad/s)(√Hz)) — Integrated white noise of sensor ((rad/s)(√Hz))

[0 0 0] (default) | real scalar | real 3-element row vector

Integrated white noise of sensor in (rad/s)(√Hz), specified as a real scalar or 3-element row vector. Any scalar input is converted into a real 3-element row vector where each element has the input scalar value.

Data Types: single | double

Bias from temperature ((rad/s)/°C) — Sensor bias from temperature ((rad/s)/°C)

[0 0 0] (default) | real scalar | real 3-element row vector

Sensor bias from temperature in (rad/s)/°C, specified as a real scalar or 3-element row vector. Any scalar input is converted into a real 3-element row vector where each element has the input scalar value.

Data Types: `single` | `double`

Temperature scale factor (%/°C) — Scale factor error from temperature (%/°C)

[0 0 0] (default) | real scalar in the range [0,100] | real 3-element row vector in the range [0,100]

Scale factor error from temperature in %/°C, specified as a real scalar or real 3-element row vector with values ranging from 0 to 100. Any scalar input is converted into a real 3-element row vector where each element has the input scalar value.

Data Types: `single` | `double`

Magnetometer

Maximum readings (μT) — Maximum sensor reading (μT)

inf (default) | real positive scalar

Maximum sensor reading in μT, specified as a real positive scalar.

Data Types: `single` | `double`

Resolution ((μT)/LSB) — Resolution of sensor measurements ((μT)/LSB)

0 (default) | real nonnegative scalar

Resolution of sensor measurements in (μT)/LSB, specified as a real nonnegative scalar.

Data Types: `single` | `double`

Constant offset bias (μT) — Constant sensor offset bias (μT)

[0 0 0] (default) | real scalar | real 3-element row vector

Constant sensor offset bias in μT, specified as a real scalar or 3-element row vector. Any scalar input is converted into a real 3-element row vector where each element has the input scalar value.

Data Types: `single` | `double`

Axis skew (%) — Sensor axes skew (%)

[0 0 0] (default) | real scalar in the range [0,100] | real 3-element row vector in the range [0,100]

Sensor axes skew in a percentage, specified as a real scalar or 3-element row vector with values ranging from 0 to 100. Any scalar input is converted into a real 3-element row vector where each element has the input scalar value.

Data Types: `single` | `double`

White noise PSD (μT/√Hz) — Power spectral density of sensor noise (μT/√Hz)

[0 0 0] (default) | real scalar | real 3-element row vector

Power spectral density of sensor noise in μT/√Hz, specified as a real scalar or 3-element row vector. Any scalar input is converted into a real 3-element row vector where each element has the input scalar value.

Data Types: `single` | `double`

Bias Instability (μT) — Instability of the bias offset (μT)

[0 0 0] (default) | real scalar | real 3-element row vector

Instability of the bias offset in μT , specified as a real scalar or 3-element row vector. Any scalar input is converted into a real 3-element row vector where each element has the input scalar value.

Data Types: `single` | `double`

Random walk ($(\mu\text{T})\cdot\sqrt{\text{Hz}}$) — Integrated white noise of sensor ($(\mu\text{T})\cdot\sqrt{\text{Hz}}$)

[0 0 0] (default) | real scalar | real 3-element row vector

Integrated white noise of sensor in $(\mu\text{T})\cdot\sqrt{\text{Hz}}$, specified as a real scalar or 3-element row vector. Any scalar input is converted into a real 3-element row vector where each element has the input scalar value.

Data Types: `single` | `double`

Bias from temperature ($\mu\text{T}/^\circ\text{C}$) — Sensor bias from temperature ($\mu\text{T}/^\circ\text{C}$)

[0 0 0] (default) | real scalar | real 3-element row vector

Sensor bias from temperature in $\mu\text{T}/^\circ\text{C}$, specified as a real scalar or 3-element row vector. Any scalar input is converted into a real 3-element row vector where each element has the input scalar value.

Data Types: `single` | `double`

Temperature scale factor ($\%/^\circ\text{C}$) — Scale factor error from temperature ($\%/^\circ\text{C}$)

[0 0 0] (default) | real scalar in the range [0,100] | real 3-element row vector in the range [0,100]

Scale factor error from temperature in $\%/^\circ\text{C}$, specified as a real scalar or real 3-element row vector with values ranging from 0 to 100. Any scalar input is converted into a real 3-element row vector where each element has the input scalar value.

Data Types: `single` | `double`

Algorithms

Accelerometer

The accelerometer model uses the ground-truth orientation and acceleration inputs and the `imuSensor` and `accelparams` properties to model accelerometer readings.

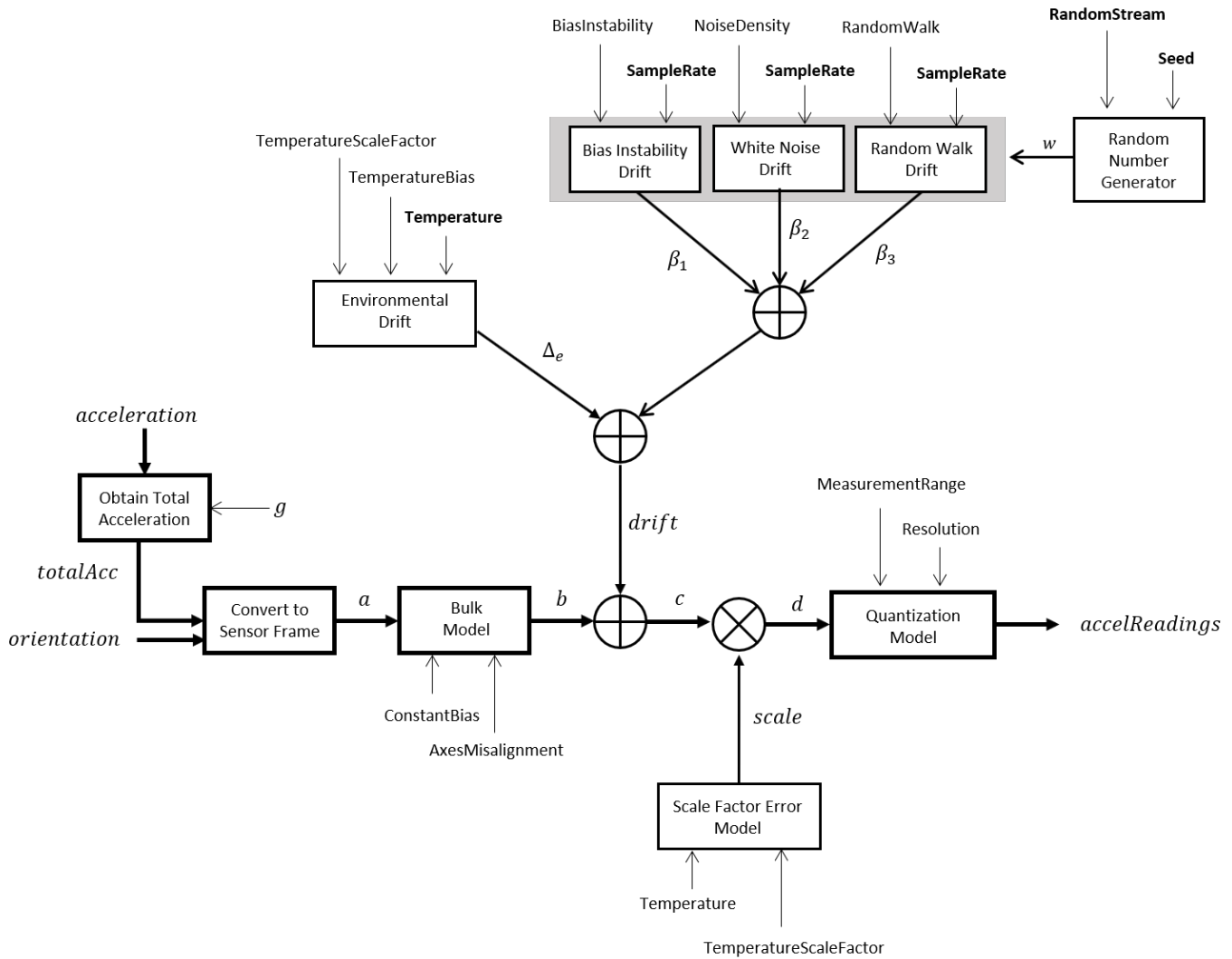

Obtain Total Acceleration

To obtain the total acceleration (*totalAcc*), the acceleration is preprocessed by negating and adding the gravity constant vector ($g = [0; 0; 9.8]$ m/s²) as:

$$totalAcc = - acceleration + g$$

Convert to Sensor Frame

Then the total acceleration is converted from the local navigation frame to the sensor frame using:

$$a = (orientation)(totalAcc)^T$$

If the orientation is input in quaternion form, it is converted to a rotation matrix before processing.

Bulk Model

The ground-truth acceleration in the sensor frame, *a*, passes through the bulk model, which adds axes misalignment and bias:

$$b = \left(\begin{bmatrix} 1 & \frac{\alpha_2}{100} & \frac{\alpha_3}{100} \\ \frac{\alpha_1}{100} & 1 & \frac{\alpha_3}{100} \\ \frac{\alpha_1}{100} & \frac{\alpha_2}{100} & 1 \end{bmatrix} (a^T) \right)^T + \text{ConstantBias}$$

where ConstantBias is a property of `accelparams`, and α_1 , α_2 , and α_3 are given by the first, second, and third elements of the AxesMisalignment property of `accelparams`.

Bias Instability Drift

The bias instability drift is modeled as white noise biased and then filtered:

$$\beta_1 = h_1 * (w)(\text{BiasInstability})$$

where BiasInstability is a property of `accelparams`, and h_1 is a filter defined by the SampleRate property:

$$H_1(z) = \frac{1}{1 - \frac{1}{2}z^{-1}}$$

White Noise Drift

White noise drift is modeled by multiplying elements of the white noise random stream by the standard deviation:

$$\beta_2 = (w) \left(\sqrt{\frac{\text{SampleRate}}{2}} \right) (\text{NoiseDensity})$$

where SampleRate is an `imuSensor` property, and NoiseDensity is an `accelparams` property. Elements of w are random numbers given by settings of the `imuSensor` random stream.

Random Walk Drift

The random walk drift is modeled by biasing elements of the white noise random stream and then filtering:

$$\beta_3 = h_2 * (w) \left(\frac{\text{RandomWalk}}{\sqrt{\frac{\text{SampleRate}}{2}}} \right)$$

where RandomWalk is a property of `accelparams`, SampleRate is a property of `imuSensor`, and h_2 is a filter defined as:

$$H_2(z) = \frac{1}{1 - z^{-1}}$$

Environmental Drift Noise

The environmental drift noise is modeled by multiplying the temperature difference from a standard with the temperature bias:

$$\Delta_e = (\text{Temperature} - 25)(\text{TemperatureBias})$$

where `Temperature` is a property of `imuSensor`, and `TemperatureBias` is a property of `accelParams`. The constant 25 corresponds to a standard temperature.

Scale Factor Error Model

The temperature scale factor error is modeled as:

$$scaleFactorError = 1 + \left(\frac{Temperature - 25}{100} \right) (TemperatureScaleFactor)$$

where `Temperature` is a property of `imuSensor`, and `TemperatureScaleFactor` is a property of `accelParams`. The constant 25 corresponds to a standard temperature.

Quantization Model

The quantization is modeled by first saturating the continuous signal model:

$$e = \begin{cases} \text{MeasurementRange} & \text{if } d > \text{MeasurementRange} \\ -\text{MeasurementRange} & \text{if } -d > \text{MeasurementRange} \\ d & \text{else} \end{cases}$$

and then setting the resolution:

$$accelReadings = (\text{Resolution}) \left(\text{round} \left(\frac{e}{\text{Resolution}} \right) \right)$$

where `MeasurementRange` is a property of `accelParams`.

Gyroscope

The gyroscope model uses the ground-truth orientation, acceleration, and angular velocity inputs, and the `imuSensor` and `gyroParams` properties to model accelerometer readings.

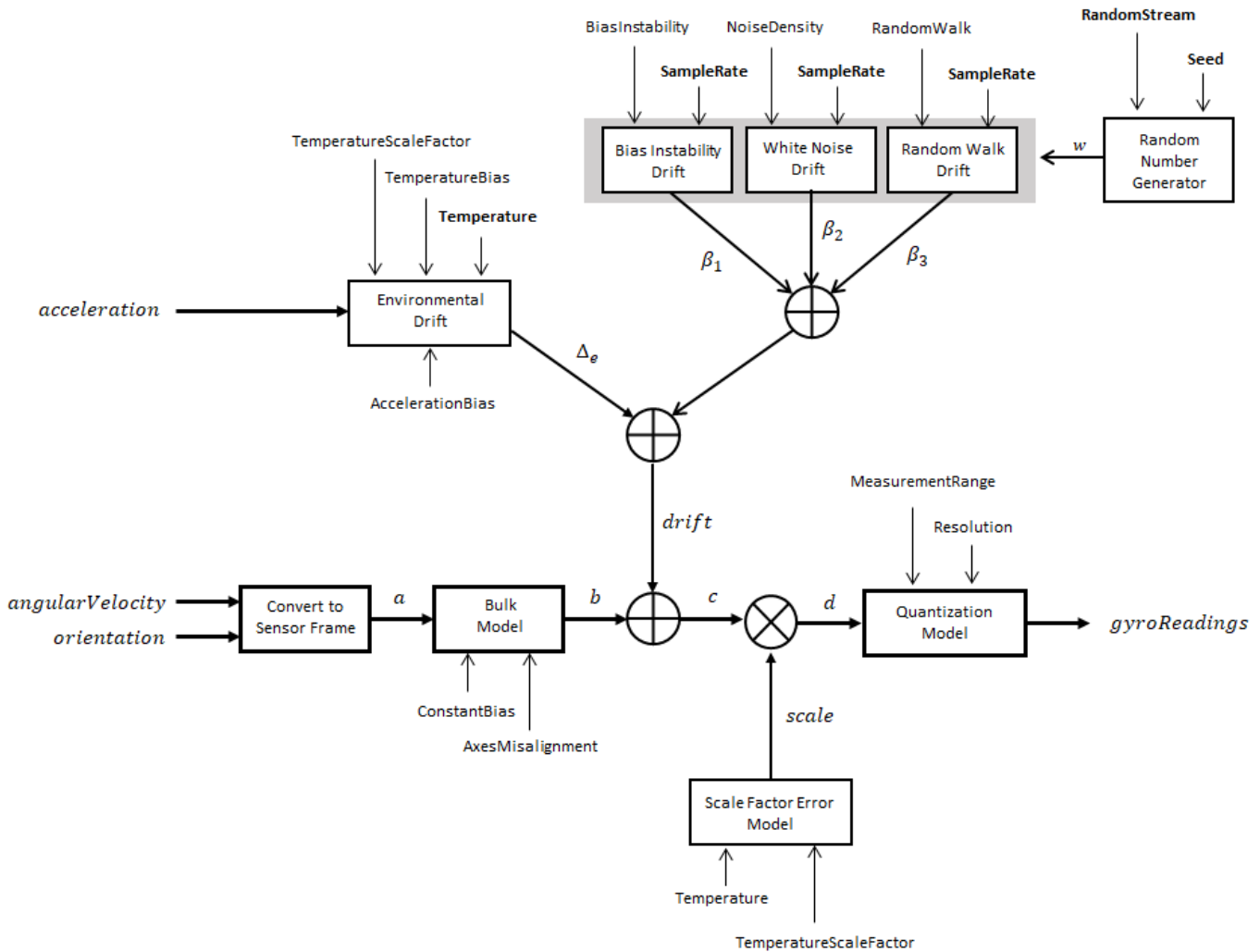

Convert to Sensor Frame

The ground-truth angular velocity is converted from the local frame to the sensor frame using the ground-truth orientation:

$$a = (orientation)(angularVelocity)^T$$

If the orientation is input in quaternion form, it is converted to a rotation matrix before processing.

Bulk Model

The ground-truth angular velocity in the sensor frame, *a*, passes through the bulk model, which adds axes misalignment and bias:

$$b = \left(\begin{bmatrix} 1 & \frac{\alpha_2}{100} & \frac{\alpha_3}{100} \\ \frac{\alpha_1}{100} & 1 & \frac{\alpha_3}{100} \\ \frac{\alpha_1}{100} & \frac{\alpha_2}{100} & 1 \end{bmatrix} (a^T) \right)^T + \text{ConstantBias}$$

where ConstantBias is a property of `gyroparams`, and α_1 , α_2 , and α_3 are given by the first, second, and third elements of the AxesMisalignment property of `gyroparams`.

Bias Instability Drift

The bias instability drift is modeled as white noise biased and then filtered:

$$\beta_1 = h_1 * (w)(\text{BiasInstability})$$

where BiasInstability is a property of `gyroparams` and h_1 is a filter defined by the SampleRate property:

$$H_1(z) = \frac{1}{1 - \frac{1}{2}z^{-1}}$$

White Noise Drift

White noise drift is modeled by multiplying elements of the white noise random stream by the standard deviation:

$$\beta_2 = (w) \left(\sqrt{\frac{\text{SampleRate}}{2}} \right) (\text{NoiseDensity})$$

where SampleRate is an `imuSensor` property, and NoiseDensity is an `gyroparams` property. The elements of w are random numbers given by settings of the `imuSensor` random stream.

Random Walk Drift

The random walk drift is modeled by biasing elements of the white noise random stream and then filtering:

$$\beta_3 = h_2 * (w) \left(\frac{\text{RandomWalk}}{\sqrt{\frac{\text{SampleRate}}{2}}} \right)$$

where RandomWalk is a property of `gyroparams`, SampleRate is a property of `imuSensor`, and h_2 is a filter defined as:

$$H_2(z) = \frac{1}{1 - z^{-1}}$$

Environmental Drift Noise

The environmental drift noise is modeled by multiplying the temperature difference from a standard with the temperature bias:

$$\Delta_e = (\text{Temperature} - 25)(\text{TemperatureBias})$$

where `Temperature` is a property of `imuSensor`, and `TemperatureBias` is a property of `gyroParams`. The constant 25 corresponds to a standard temperature.

Scale Factor Error Model

The temperature scale factor error is modeled as:

$$scaleFactorError = 1 + \left(\frac{Temperature - 25}{100} \right) (TemperatureScaleFactor)$$

where `Temperature` is a property of `imuSensor`, and `TemperatureScaleFactor` is a property of `gyroParams`. The constant 25 corresponds to a standard temperature.

Quantization Model

The quantization is modeled by first saturating the continuous signal model:

$$e = \begin{cases} \text{MeasurementRange} & \text{if } d > \text{MeasurementRange} \\ -\text{MeasurementRange} & \text{if } -d > \text{MeasurementRange} \\ d & \text{else} \end{cases}$$

and then setting the resolution:

$$gyroReadings = (\text{Resolution}) \left(\text{round} \left(\frac{e}{\text{Resolution}} \right) \right)$$

where `MeasurementRange` is a property of `gyroParams`.

Magnetometer

The magnetometer model uses the ground-truth orientation and acceleration inputs, and the `imuSensor` and `magParams` properties to model magnetometer readings.

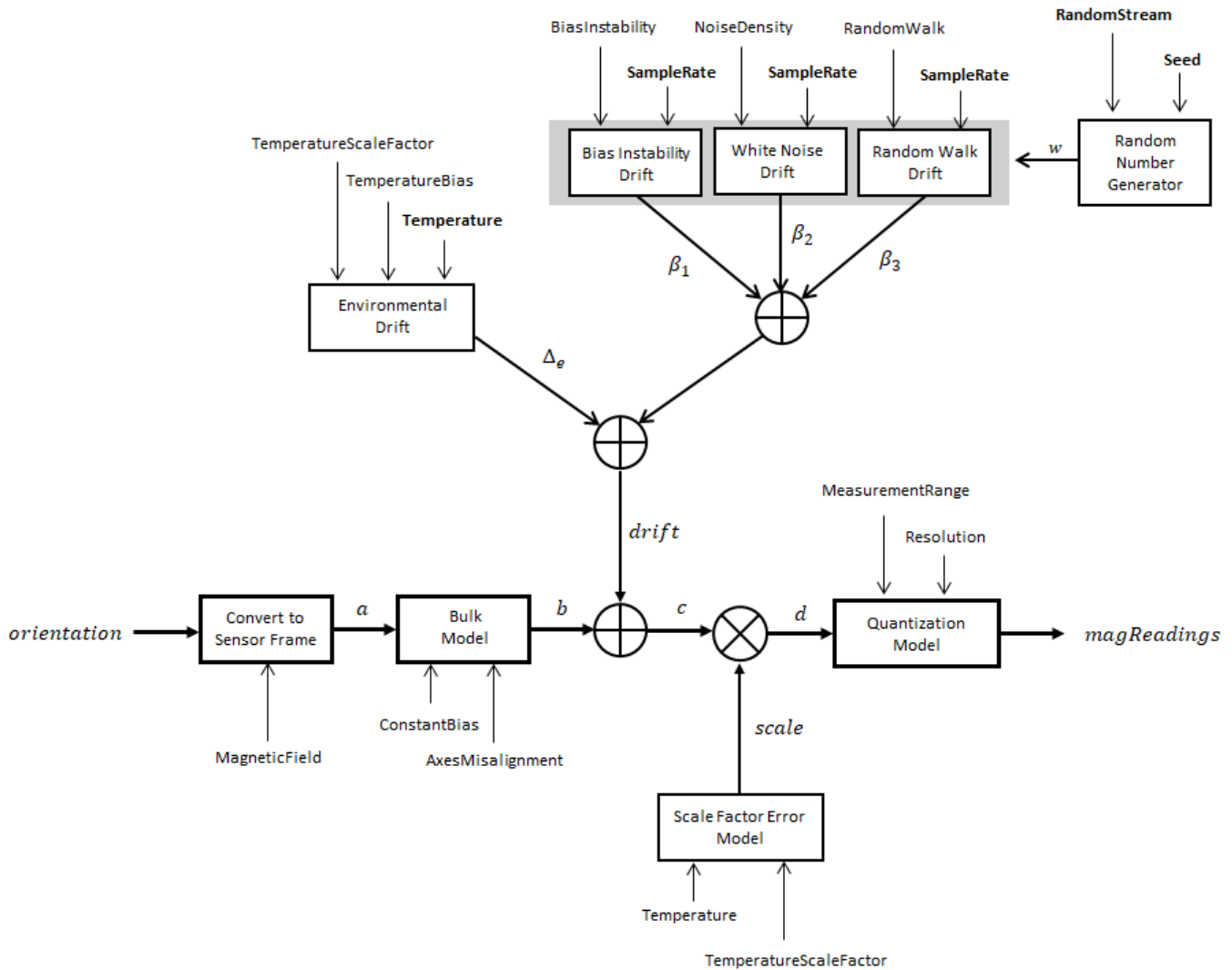

Convert to Sensor Frame

The ground-truth acceleration is converted from the local frame to the sensor frame using the ground-truth orientation:

$$a = (orientation)(totalAcc)^T$$

If the orientation is input in quaternion form, it is converted to a rotation matrix before processing.

Bulk Model

The ground-truth acceleration in the sensor frame, *a*, passes through the bulk model, which adds axes misalignment and bias:

$$b = \left(\begin{bmatrix} 1 & \frac{\alpha_2}{100} & \frac{\alpha_3}{100} \\ \frac{\alpha_1}{100} & 1 & \frac{\alpha_3}{100} \\ \frac{\alpha_1}{100} & \frac{\alpha_2}{100} & 1 \end{bmatrix} (a^T) \right)^T + \text{ConstantBias}$$

where ConstantBias is a property of magparams, and α_1 , α_2 , and α_3 are given by the first, second, and third elements of the AxesMisalignment property of magparams.

Bias Instability Drift

The bias instability drift is modeled as white noise biased and then filtered:

$$\beta_1 = h_1 * (w)(\text{BiasInstability})$$

where BiasInstability is a property of magparams and h_1 is a filter defined by the SampleRate property:

$$H_1(z) = \frac{1}{1 - \frac{1}{2}z^{-1}}$$

White Noise Drift

White noise drift is modeled by multiplying elements of the white noise random stream by the standard deviation:

$$\beta_2 = (w) \left(\sqrt{\frac{\text{SampleRate}}{2}} \right) (\text{NoiseDensity})$$

where SampleRate is an imuSensor property, and NoiseDensity is an magparams property. The elements of w are random numbers given by settings of the imuSensor random stream.

Random Walk Drift

The random walk drift is modeled by biasing elements of the white noise random stream and then filtering:

$$\beta_3 = h_2 * (w) \left(\frac{\text{RandomWalk}}{\sqrt{\frac{\text{SampleRate}}{2}}} \right)$$

where RandomWalk is a property of magparams, SampleRate is a property of imuSensor, and h_2 is a filter defined as:

$$H_2(z) = \frac{1}{1 - z^{-1}}$$

Environmental Drift Noise

The environmental drift noise is modeled by multiplying the temperature difference from a standard with the temperature bias:

$$\Delta_e = (\text{Temperature} - 25)(\text{TemperatureBias})$$

where `Temperature` is a property of `imuSensor`, and `TemperatureBias` is a property of `magparams`. The constant 25 corresponds to a standard temperature.

Scale Factor Error Model

The temperature scale factor error is modeled as:

$$scaleFactorError = 1 + \left(\frac{Temperature - 25}{100} \right) (TemperatureScaleFactor)$$

where `Temperature` is a property of `imuSensor`, and `TemperatureScaleFactor` is a property of `magparams`. The constant 25 corresponds to a standard temperature.

Quantization Model

The quantization is modeled by first saturating the continuous signal model:

$$e = \begin{cases} \text{MeasurementRange} & \text{if } d > \text{MeasurementRange} \\ -\text{MeasurementRange} & \text{if } -d > \text{MeasurementRange} \\ d & \text{else} \end{cases}$$

and then setting the resolution:

$$magReadings = (\text{Resolution}) \left(\text{round} \left(\frac{e}{\text{Resolution}} \right) \right)$$

where `MeasurementRange` is a property of `magparams`.

Extended Capabilities

C/C++ Code Generation

Generate C and C++ code using Simulink® Coder™.

See Also

Classes

`accelparams` | `gyroparams` | `magparams`

Objects

`gpsSensor` | `imuSensor` | `insSensor`

Topics

“Model IMU, GPS, and INS/GPS”

Introduced in R2020a

INS

Simulate INS sensor

Library: Navigation Toolbox / Multisensor Positioning / Sensor Models
Sensor Fusion and Tracking Toolbox / Multisensor Positioning / Sensor Models

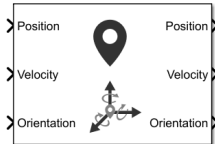

Description

The block simulates an INS sensor, which outputs noise-corrupted position, velocity, and orientation based on the corresponding inputs. To change the level of noise present in the output, you can vary the roll, pitch, yaw, position, and velocity accuracies. The accuracy is defined as the standard deviation of the noise.

Ports

Input

Position — Position of INS sensor

N -by-3 matrix of scalar

Position of the INS sensor relative to the navigation frame, specified as an N -by-3 matrix of scalars. N is the number of samples.

Data Types: `single` | `double`

Velocity — Velocity of INS sensor

N -by-3 matrix of scalar

Velocity of the INS sensor relative to the navigation frame, specified as an N -by-3 matrix of scalars. N is the number of samples.

Data Types: `single` | `double`

Orientation — Orientation of INS sensor

3-by-3-by- N array of scalar | N -by-4 matrix of scalar

Orientation of the INS sensor relative to the navigation frame, specified as either a 3-by-3-by- N array of scalars, where each page of the array (3-by-3 matrix) is a rotation matrix or as an N -by-4 matrix of scalars, where each row of the matrix is the four elements of a quaternion. N is the number of samples.

Data Types: `single` | `double`

Output

Position — Position of INS sensor

N-by-3 matrix of scalar

Position of the INS sensor relative to the navigation frame, returned as an *N*-by-3 matrix of scalars. *N* is the number of samples in the input.

Data Types: `single` | `double`

Velocity — Velocity of INS sensor

N-by-3 matrix of scalar

Velocity of the INS sensor relative to the navigation frame, returned as an *N*-by-3 matrix of scalars. *N* is the number of samples in the inputs.

Data Types: `single` | `double`

Orientation — Orientation of INS sensor

3-by-3-by-*N* array of scalar | *N*-by-4 matrix of scalar

Orientation of the INS sensor relative to the navigation frame, returned either as a 3-by-3-by-*N* array of scalars, where each page of the array (3-by-3 matrix) is a rotation matrix, or an *N*-by-4 matrix of scalars, where each row of the matrix is the four elements of a quaternion. The exact type of orientation output follows the type of orientation input. *N* is the number of samples in the input.

Data Types: `single` | `double`

Parameters

Roll (X-axis) Accuracy (deg) — Accuracy of roll measurement (deg)

0.2 (default) | nonnegative real scalar

Accuracy of the roll measurement of the sensor body in degrees, specified as a nonnegative real scalar.

Roll is defined as rotation around the *x*-axis of the sensor body. Roll noise is modeled as white process noise with standard deviation equal to the specified **Roll accuracy** in degrees.

Data Types: `single` | `double`

Pitch (Y-axis) Accuracy (deg) — Accuracy of pitch measurement (deg)

0.2 (default) | nonnegative real scalar

Accuracy of the pitch measurement of the sensor body in degrees, specified as a nonnegative real scalar.

Pitch is defined as rotation around the *y*-axis of the sensor body. Pitch noise is modeled as white process noise with standard deviation equal to the specified **Pitch Accuracy** in degrees.

Data Types: `single` | `double`

Yaw (Z-axis) Accuracy (deg) — Accuracy of yaw measurement (deg)

1 (default) | nonnegative real scalar

Accuracy of the yaw measurement of the sensor body in degrees, specified as a nonnegative real scalar.

Yaw is defined as rotation around the z-axis of the sensor body. Yaw noise is modeled as white process noise with standard deviation equal to the specified **Yaw Accuracy** in degrees.

Data Types: `single` | `double`

Position Accuracy (m) — Accuracy of position measurement (deg)

1 (default) | nonnegative real scalar

Accuracy of the position measurement of the sensor body in meters, specified as a nonnegative real scalar.

Position noise is modeled as white process noise with a standard deviation equal to the specified **Position Accuracy** in degrees.

Data Types: `single` | `double`

Velocity Accuracy (m/s) — Accuracy of velocity measurement (deg)

1 (default) | nonnegative real scalar

Accuracy of the velocity measurement of the sensor body in meters per second, specified as a nonnegative real scalar.

Velocity noise is modeled as white process noise with a standard deviation equal to the specified **Velocity Accuracy** in degrees.

Data Types: `single` | `double`

Initial Seed — Initial seed for randomization

67 (default) | nonnegative integer

Initial seed of a random number generator algorithm, specified as a nonnegative integer.

Data Types: `single` | `double`

Simulate using — Type of simulation to run

`Interpreted Execution` (default) | `Code Generation`

- `Interpreted execution` — Simulate the model using the MATLAB interpreter. This option shortens startup time. In `Interpreted execution` mode, you can debug the source code of the block.
- `Code generation` — Simulate the model using generated C code. The first time that you run a simulation, Simulink generates C code for the block. The C code is reused for subsequent simulations if the model does not change. This option requires additional startup time.

See Also

IMU | `insSensor`

Introduced in R2020b

Joint Probabilistic Data Association Multi Object Tracker

Joint probabilistic data association tracker

Library: Sensor Fusion and Tracking Toolbox / Multi-Object Tracking Algorithms



Description

The Joint Probabilistic Data Association Multi Object Tracker block is capable of processing detections of multiple targets from multiple sensors. The tracker uses joint probabilistic data association to assign detections to each track. The tracker applies a soft assignment, in which multiple detections can contribute to each track. The tracker initializes, confirms, corrects, predicts (performs coasting), and deletes tracks. The tracker estimates the state vector and state estimate error covariance matrix for each track. Each detection is assigned to at least one track. If the detection cannot be assigned to any existing track, the tracker creates a new track.

Any new track starts in a *tentative* state. If enough detections are assigned to a tentative track, its status changes to *confirmed*. If the detection already has a known classification (the `ObjectClassID` field of the returned track is nonzero), that corresponding track is confirmed immediately. When a track is confirmed, the tracker considers the track to represent a physical object. If detections are not assigned to the track within a specifiable number of updates, the track is deleted.

Ports

Input

Detections – Detection list

Simulink bus containing MATLAB structure

Detection list, specified as a Simulink bus containing a MATLAB structure. The structure has the form:

Field	Description	Type
NumDetections	Number of detections	Integer
Detections	Object detections	Array of <code>objectDetection</code> structures. The first <code>NumDetections</code> of these detections are actual detections.

The fields of detections are:

Field	Description	Type
Time	Measurement time	Single or Double

Field	Description	Type
Measurement	Object measurements	Single or Double
MeasurementNoise	Measurement noise covariance matrix	Single or Double
SensorIndex	Unique ID of the sensor	Single or Double
ObjectClassID	Object classification ID	Single or Double
MeasurementParameters	Parameters used by initialization functions of tracking filters	Simulink Bus
ObjectAttributes	Additional information passed to tracker	Simulink Bus

See `objectDetection` for more detailed explanation of these fields.

Note The object detection structure contains a `Time` field. The time tag of each object detection must be less than or equal to the time of the current invocation of the block. The time tag must also be greater than the update time specified in the previous invocation of the block.

Prediction Time – Track update time

real scalar

Track update time, specified as a real scalar in seconds. The tracker updates all tracks to this time. The update time must always increase with each invocation of the block. The update time must be at least as large as the largest `Time` specified in the **Detections** input port.

If the port is not enabled, the simulation clock managed by Simulink determines the update time.

Dependencies

To enable this port, on the **Port Setting** tab, set **Prediction time source** to `Input` port.

Cost Matrix – Cost matrix

real-valued N_t -by- N_d matrix

Cost matrix, specified as a real-valued N_t -by- N_d matrix, where N_t is the number of existing tracks and N_d is the number of current detections.

The rows of the cost matrix correspond to the existing tracks. The columns correspond to the detections. Tracks are ordered as they appear in the list of tracks from the **All Tracks** output port on the previous invocation of the block.

In the first update to the tracker, or if the tracker has no previous tracks, assign the cost matrix a size of $[0, N_d]$. The cost must be calculated so that lower costs indicate a higher likelihood that the tracker assigns a detection to a track. To prevent certain detections from being assigned to certain tracks, use `Inf`.

If this port is not enabled, the filter initialized by the **Filter initialization function** calculates the cost matrix using the distance method.

Dependencies

To enable this port, on the **Port Setting** tab, select **Enable cost matrix input**.

Detectable TrackIDs — Detectable track IDs

real-valued M -by-1 vector | real-valued M -by-2 matrix

Detectable track IDs, specified as a real-valued M -by-1 vector or M -by-2 matrix. Detectable tracks are tracks that the sensors expect to detect. The first column of the matrix contains a list of track IDs that the sensors report as detectable. The optional second column enables you to add the detection probability for each track.

Tracks whose identifiers are not included in **Detectable TrackIDs** are considered undetectable. The track deletion logic does not count the lack of detection as a "missed detection" for track deletion purposes.

If this port is not enabled, the tracker assumes all tracks to be detectable at each invocation of the block.

Dependencies

To enable this port, on the **Port Setting** tab, select **Enable detectable track IDs Input**.

State Parameters — Track state parameters

Simulink bus containing MATLAB structure

Track state parameters, specified as a Simulink bus containing a MATLAB structure. The structure has the form:

Field	Description
NumParameters	Number of non-default state parameters, specified as a nonnegative integer
Parameters	Array of state parameter structures

The block uses the value of the `Parameters` field for the `StateParameters` field of the generated tracks. You can use these parameters to define the reference frame in which the track is reported or other desirable attributes of the generated tracks.

For example, you can use the following structure to define a rectangular reference frame whose origin position is at $[10 \ 10 \ 0]$ meters and whose origin velocity is $[2 \ -2 \ 0]$ meters per second with respect to the scenario frame.

Field Name	Value
Frame	"Rectangular"
Position	$[10 \ 10 \ 0]$
Velocity	$[2 \ -2 \ 0]$

Dependencies

To enable this port, in the **Tracker Configuration** tab, select the **Update track state parameters with time** parameter.

Output

Confirmed Tracks – Confirmed tracks

Simulink bus containing MATLAB structure

Confirmed tracks, returned as a Simulink bus containing a MATLAB structure. The structure has the form:

Field	Description
NumTracks	Number of tracks
Tracks	Array of track structures of a length set by the Maximum number of tracks parameter. Only the first NumTracks of these are actual tracks.

The fields of the track structure are shown in “Track Structure” on page 4-89.

Depending on the track logic, a track is confirmed if:

- History – A track receives at least M detections in the last N updates. M and N are specified in **Confirmation threshold** for the History logic.
- Integrated – The integrated probability of track existence is higher than the confirmation threshold specified in **Confirmation threshold** for the Integrated logic.

Tentative Tracks – Tentative tracks

Simulink bus containing MATLAB structure

Tentative tracks, returned as a Simulink bus containing a MATLAB structure. A track is tentative before it is confirmed.

The fields of the track structure are shown in “Track Structure” on page 4-89.

Dependencies

To enable this port, on the **Port Setting** tab, select **Enable tentative tracks output**.

All Tracks – Confirmed and tentative tracks

Simulink bus containing MATLAB structure

Combined list of confirmed and tentative tracks, returned as a Simulink bus containing a MATLAB structure.

The fields of the track structure are shown in “Track Structure” on page 4-89.

Dependencies

To enable this port, on the **Port Setting** tab, select **Enable all tracks output**.

Info – Additional information for analyzing track updates

Simulink bus containing MATLAB structure

Additional information for analyzing track updates, returned as a Simulink bus containing a MATLAB structure.

This table shows the fields of the info structure:

Field	Description
TrackIDsAtStepBeginning	Track IDs when step began.
CostMatrix	Cost matrix for assignment.
Clusters	Cell array of cluster reports. See “Feasible Joint Events” on page 4-88 for more details.
InitiatedTrackIDs	IDs of tracks initiated during the step.
DeletedTrackIDs	IDs of tracks deleted during the step.
TrackIDsAtStepEnd	Track IDs when the step ended.

The Clusters field can include multiple cluster reports. Each cluster report is a structure containing:

Field	Description
DetectionIndices	Indices of clustered detections.
TrackIDs	Track IDs of clustered tracks.
ValidationMatrix	Validation matrix of the cluster. See “Feasible Joint Events” on page 4-88 for more details.
SensorIndex	Index of the originating sensor of the clustered detections.
TimeStamp	Mean time stamp of clustered detections.
MarginalProbabilities	Matrix of marginal posterior joint association probabilities.

Dependencies

To enable this port, on the **Port Setting** tab, select **Enable information output**.

Parameters

Tracker Management

Filter initialization function – Filter initialization function

@initcvkf (default) | function handle | character vector

Filter initialization function, specified as a function handle or as a character vector containing the name of a valid filter initialization function. The tracker uses the filter initialization function when creating new tracks.

Sensor Fusion and Tracking Toolbox supplies many initialization functions:

Initialization Function	Function Definition
initcvkf	Initialize constant-velocity linear Kalman filter.
initcakf	Initialize constant-acceleration linear Kalman filter.
initcvabf	Initialize constant-velocity alpha-beta filter
initcaabf	Initialize constant-acceleration alpha-beta filter

Initialization Function	Function Definition
<code>initcvekf</code>	Initialize constant-velocity extended Kalman filter.
<code>initcaekf</code>	Initialize constant-acceleration extended Kalman filter.
<code>initrpekf</code>	Initialize constant-velocity range-parametrized extended Kalman filter.
<code>initapekf</code>	Initialize constant-velocity angle-parametrized extended Kalman filter.
<code>initctekf</code>	Initialize constant-turn-rate extended Kalman filter.
<code>initcackf</code>	Initialize constant-acceleration cubature filter.
<code>initctckf</code>	Initialize constant-turn-rate cubature filter.
<code>initcvckf</code>	Initialize constant-velocity cubature filter.
<code>initcvukf</code>	Initialize constant-velocity unscented Kalman filter.
<code>initcaukf</code>	Initialize constant-acceleration unscented Kalman filter.
<code>initctukf</code>	Initialize constant-turn-rate unscented Kalman filter.
<code>initcvmscekf</code>	Initialize constant-velocity extended Kalman filter in modified spherical coordinates.
<code>initekfimm</code>	Initialize tracking IMM filter.

You can also write your own initialization function using this syntax:

```
filter = filterInitializationFcn(detection)
```

The input to this function is a detection report like those created by `objectDetection`. The output of this function must be a filter object: `trackingKF`, `trackingEKF`, `trackingUKF`, `trackingCKF`, `trackingGSF`, `trackingIMM`, `trackingMSCEKF`, or `trackingABF`.

For guidance in writing this function, use the `type` command to examine the details of built-in MATLAB functions. For example:

```
type initcvekf
```

Note `trackerJPDA` does not accept all filter initialization functions in Sensor Fusion and Tracking Toolbox. The full list of filter initialization functions available in Sensor Fusion and Tracking Toolbox are given in the **Initialization** section of “Estimation Filters”.

Value of k for k-best JPDA — Value of k for k-best JPDA

`inf` (default) | positive integer

Value of k for k-best JPDA, specified as a positive integer. This parameter defines the maximum number of feasible joint events for the track and detection association of each cluster. Setting this property to a finite value enables you to run a k-best JPDA tracker, which generates a maximum of k events per cluster.

Feasible joint events generation function name — Feasible joint events generation function name

@jpdEvents (default) | function handle | character vector

Feasible joint events generation function name, specified as a function handle or as a character vector containing the name of a feasible joint events generation function. A generation function generates feasible joint event matrices from admissible events (usually given by a validation matrix or a likelihood matrix) of a scenario. For details, see `jpdEvents`.

You can also write your own generation function.

- If the **Value of k for k-best JPDA** parameter is set to `inf`, the function must have the following syntax:

```
FJE = myfunction(ValidationMatrix)
```

The input and out of this function must exactly follow the formats used in `jpdEvents`.

- If the **Value of k for k-best JPDA** parameter is set to a finite value, the function must have the following syntax:

```
[FJE,FJEProbs] = myfunction(likelihoodMatrix,k)
```

The input and out of this function must exactly follow the formats used in `jpdEvents`.

For guidance in writing this function, use the `type` command to examine the details of `jpdEvents`:

```
type jpdEvents
```

Example: @myfunction or 'myfunction'

Maximum number of tracks — Maximum number of tracks

100 (default) | positive integer

Maximum number of tracks that the block can maintain, specified as a positive integer.

Maximum number of sensors — Maximum number of sensors

20 (default) | positive integer

Maximum number of sensors that the block can process, specified as a positive integer. This value should be greater than or equal to the highest `SensorIndex` value input at the **Detections** input port.

Absolute tolerance between time stamps of detections — Absolute tolerance between time stamps of detections

20 (default) | positive integer

Absolute time tolerance between detections for the same sensor, specified as a positive scalar. The block expects detections from a sensor to have identical time stamps. However, if the time stamp differences between detections of a sensor are within the margin specified by this parameter, these detections will be used to update the track estimate based on the average time of these detections.

Out-of-sequence measurements handling — Out-of-sequence measurements handling

Terminate (default) | Neglect

Out-of-sequence measurements handling, specified as `Terminate` or `Neglect`. Each detection has a timestamp associated with it, t_d , and the tracker block has its own timestamp, t_t , which is updated in each invocation. The tracker block considers a measurement as an OOSM if $t_d < t_t$.

When the parameter is specified as:

- `Terminate` — The block stops running when it encounters any out-of-sequence measurements.
- `Neglect` — The block neglects any out-of-sequence measurements and continues to run.

Note The tracker requires all input detections that share the same `SensorIndex` have their `Time` differences bounded by the **Absolute tolerance between time stamps of detections** parameter. Therefore, when you set the **Out-of-sequence measurements handling** parameter to `Neglect`, you must make sure that the out-of-sequence detections have timestamps strictly less than the previous timestamp when running the tracker.

Track state parameters — Parameters of track state reference frame

structure | structure array

Parameters of the track state reference frame, specified as a structure or a structure array. The block passes the value of this parameter to the `StateParameters` field of the generated tracks. You can use these parameters to define the reference frame in which the track is reported or other desirable attributes of the generated tracks.

For example, you can use the following structure to define a rectangular reference frame whose origin position is at `[10 10 0]` meters and whose origin velocity is `[2 -2 0]` meters per second with respect to the scenario frame.

Field Name	Value
Frame	"Rectangular"
Position	[10 10 0]
Velocity	[2 -2 0]

You can update the track state parameters through the **State Parameters** input port by selecting the **Update track state parameters with time** parameter.

Data Types: `struct`

Update track state parameters with time — Update track state parameters with time

off (default) | on

Select this parameter to enable the input port for track state parameters through the **State Parameters** input port.

Simulate using — Type of simulation to run

Interpreted Execution (default) | Code Generation

- `Interpreted execution` — Simulate the model using the MATLAB interpreter. This option shortens startup time. In `Interpreted execution` mode, you can debug the source code of the block.
- `Code generation` — Simulate the model using generated C code. The first time you run a simulation, Simulink generates C code for the block. The C code is reused for subsequent simulations as long as the model does not change. This option requires additional startup time.

Assignment**Threshold for assigning detections to tracks – Threshold for assigning detections to tracks**

30*[1 Inf] (default) | positive scalar | 1-by-2 vector of positive values

Threshold for assigning detections to tracks (or gating threshold), specified as a positive scalar or 1-by-2 vector of $[C_1, C_2]$, where $C_1 \leq C_2$. If specified as a scalar, the specified value, *val*, is expanded to $[val, Inf]$.

Initially, the tracker executes a coarse estimation for the normalized distance between all the tracks and detections. The tracker only calculates the accurate normalized distance for the combinations whose coarse normalized distance is less than C_2 . Also, the tracker can only assign a detection to a track if the accurate normalized distance between them is less than C_1 . See the `distance` function used with tracking filters (such as `trackingCKF` and `trackingEKF`) for explanation of the distance calculation.

Tips:

- Increase the value of C_2 if there are track and detection combinations that should be calculated for assignment but are not. Decrease this value if the cost calculation takes too much time.
- Increase the value of C_1 if there are detections that should be assigned to tracks but are not. Decrease this value if there are detections that are assigned to tracks they should not be assigned to (too far away).

Threshold to initialize a track – Threshold to initialize a track

0 (default) | scalar in the range [0, 1]

The probability threshold to initialize a new track, specified as a scalar in the range [0, 1]. If the probabilities of associating a detection with any of the existing tracks are all smaller than `InitializationThreshold`, the detection is used to initialize a new track. This allows detections that are within the validation gate of a track but have an association probability lower than the initialization threshold to spawn a new track.

Example: 0.1

Probability of detection – Probability of detection

0.9 (default) | scalar in the range [0, 1]

Probability of detection, specified as a scalar in the range [0, 1]. This property is used in calculations of the marginal posterior probabilities of association and the probability of track existence when initializing and updating a track.

Spatial density of clutter measurements – Spatial density of clutter measurements

1e-5 (default) | positive scalar

Spatial density of clutter measurements, specified as a positive scalar. The clutter density describes the expected number of false positive detections per unit volume. It is used as the parameter of a Poisson clutter model. When **Type of track confirmation and deletion logic** is set to 'Integrated', this parameter is also used in calculating the initial probability of track existence.

Track Logic**Type of track confirmation and deletion logic – Confirmation and deletion logic type**

History (default) | Integrated

Confirmation and deletion logic type, selected as:

- **History** - Track confirmation and deletion is based on the number of times the track has been assigned to a detection in the latest tracker updates.
- **Integrated** - Track confirmation and deletion is based on the probability of track existence, which is integrated in the assignment function.

Confirmation threshold [M N] – Track confirmation threshold for history logic

[2, 3] (default) | real-valued 1-by-2 vector of positive integers

Track confirmation threshold for history logic, specified as a real-valued 1-by-2 vector of positive integers [M N]. A track is confirmed if it receives at least M detections in the last N updates.

DependenciesTo enable this parameter, set **Type of track confirmation and deletion logic** to 'History'.**Deletion threshold [P Q] – Track deletion threshold for history logic**

[5, 5] (default) | real-valued 1-by-2 vector of positive integers

Track deletion threshold for history logic, specified as a real-valued 1-by-2 vector of positive integers, [P Q]. If, in P of the last Q tracker updates, a confirmed track is not assigned to any detection that has a likelihood greater than the **Threshold for registering 'hit' or 'miss'** parameter, then that track is deleted.**Dependencies**To enable this parameter, set **Type of track confirmation and deletion logic** to 'History'.**Threshold for registering 'hit' or 'miss' – Threshold for registering a 'Hit' or a 'Miss'**

0.2 (default) | scalar in the range [0, 1]

Threshold for registering a 'hit' or 'miss', specified as a scalar in the range [0, 1]. The track history logic registers a 'miss' and the track will be coasted if the sum of the marginal probabilities of assignments is below the HitMissThreshold. Otherwise, the track history logic registers a 'hit'.

DependenciesTo enable this parameter, set **Type of track confirmation and deletion logic** to 'History'.**Confirmation threshold [Probability] – Track confirmation threshold for integrated logic**

0.95 (default) | positive scalar

Track confirmation threshold for integrated logic, specified as a real-valued positive scalar. A track is confirmed if its probability of existence is greater than or equal to the confirmation threshold.

DependenciesTo enable this parameter, set **Type of track confirmation and deletion logic** to 'Integrated'.

Deletion threshold [Probability] – Track deletion threshold for integrated logic

0.1 (default) | positive scalar

Track deletion threshold for integrated logic, specified as a positive scalar. A track is deleted if its probability of existence drops below this threshold.

Dependencies

To enable this parameter, set **Type of track confirmation and deletion logic** to 'Integrated'.

Spatial density of new targets – Spatial density of new targets

1e-5 (default) | positive scalar

Spatial density of new targets, specified as a positive scalar. The new target density describes the expected number of new tracks per unit volume in the measurement space. It is used in calculating the probability of track existence during track initialization.

Dependencies

To enable this parameter, set **Type of track confirmation and deletion logic** to 'Integrated'.

Time rate of true target deaths – Time rate of true target deaths

0.01 (default) | scalar in the range [0, 1]

Time rate of true target deaths, specified as a scalar in the range [0, 1]. This parameter describes the probability with which true targets disappear. It is related to the propagation of the probability of track existence (*PTE*) :

$$PTE(t + \delta t) = (1 - DeathRate)^{\delta t} PTE(t)$$

where *DeathRate* is the time rate of true target deaths, and δt is the time interval since the previous update time *t*.

Dependencies

To enable this parameter, set **Type of track confirmation and deletion logic** to 'Integrated'.

Port Setting**Prediction time source – Source of prediction time**

Auto (default) | Input port

Source for prediction time, specified as Input port or Auto. Select Input port to input an update time by using the **Prediction Time** input port. Otherwise, the simulation clock managed by Simulink determines the update time.

Enable cost matrix input – Enable input port for cost matrix

off (default) | on

Select this check box to enable the input of a cost matrix by using the **Cost Matrix** input port.

Enable detectable track IDs input – Enable detectable track IDs input

off (default) | on

Select this check box to enable the **Detectable track IDs** input port.

Enable tentative tracks output – Enable output port for tentative tracks

off (default) | on

Select this check box to enable the output of tentative tracks through the **Tentative Tracks** output port.

Enable all tracks output – Enable output port for all tracks

off (default) | on

Select this check box to enable the output of all the tracks through the **All Tracks** output port.

Enable information output – Enable output port for analysis information

off (default) | on

Select this check box to enable the output port for analysis information through the **Info** output port.

Source of output bus name – Source of output track bus name

Auto (default) | Property

Source of the output track bus name, specified as:

- **Auto** — The block automatically creates an output track bus name.
- **Property** — Specify the output track bus name by using the **Specify an output bus name** parameter.

Source of output info bus name – Source of output info bus name

Auto (default) | Property

Source of the output info bus name, specified as one of these options:

- **Auto** — The block automatically creates an output info bus name.
- **Property** — Specify the output info bus name by using the **Specify an output bus name** parameter.

Algorithms

Tracker Logic Flow

When a joint probabilistic data association (JPDA) tracker processes detections, track creation and management follow these steps:

- 1 The tracker divides detections into multiple groups by originating sensor.
- 2 For each sensor:
 - a The tracker calculates the distances from detections to existing tracks and forms a `costMatrix`.
 - b The tracker creates a validation matrix based on the assignment threshold (or gate threshold) of the existing tracks. A validation matrix is a binary matrix listing all possible detections-to-track associations. For details, see “Feasible Joint Events” on page 4-88.
 - c Tracks and detections are then separated into clusters. A cluster can contain one track or multiple tracks if these tracks share common detections within their validation gates. A validation gate is a spatial boundary, in which the predicted detection of the track has a high likelihood to fall. For details, see “Feasible Joint Events” on page 4-88.

- 3 Update all clusters following the order of the mean detection time stamp within the cluster. For each cluster, the tracker:
 - a Generates all feasible joint events. For details, see `jpdaEvents`.
 - b Calculates the posterior probability of each joint event.
 - c Calculates the marginal probability of each individual detection-track pair in the cluster.
 - d Reports weak detections. Weak detections are the detections that are within the validation gate of at least one track, but have probability association to all tracks less than the `InitializationThreshold`.
 - e Updates tracks in the cluster using `correctjpda`.
- 4 Unassigned detections (detections not in any cluster) and weak detections spawn new tracks.
- 5 The tracker checks all tracks for deletion. Tracks are deleted based on the number of scans without association using 'History' logic or based on their probability of existence using 'Integrated' track logic.
- 6 All tracks are predicted to the latest time value (either the time input if provided, or the latest mean cluster time stamp).

Feasible Joint Events

In the typical workflow for a tracking system, the tracker needs to determine if a detection can be associated with any of the existing tracks. If the tracker only maintains one track, the assignment can be done by evaluating the validation gate around the predicted measurement and deciding if the measurement falls within the *validation gate*. In the measurement space, the validation gate is a spatial boundary, such as a 2-D ellipse or a 3-D ellipsoid, centered at the predicted measurement. The validation gate is defined using the probability information (state estimation and covariance, for example) of the existing track, such that the correct or ideal detections have high likelihood (97% probability, for example) of falling within this validation gate.

However, if a tracker maintains multiple tracks, the data association process becomes more complicated, because one detection can fall within the validation gates of multiple tracks. For example, in the following figure, tracks T_1 and T_2 are actively maintained in the tracker, and each of them has its own validation gate. Since the detection D_2 is in the intersection of the validation gates of both T_1 and T_2 , the two tracks (T_1 and T_2) are connected and form a *cluster*. A cluster is a set of connected tracks and their associated detections.

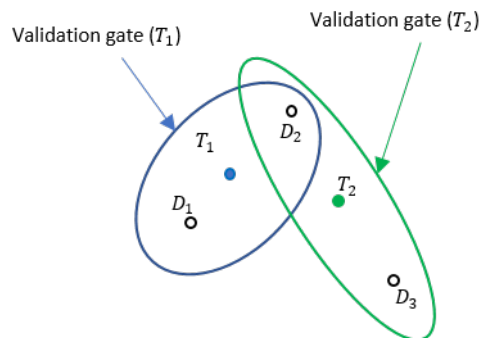

To represent the association relationship in a cluster, the validation matrix is commonly used. Each row of the validation matrix corresponds to a detection while each column corresponds to a track. To account for the eventuality of each detection being clutter, a first column is added and usually referred to as "Track 0" or T_0 . If detection D_i is inside the validation gate of track T_j , then the $(j, i+1)$

entry of the validation matrix is 1. Otherwise, it is zero. For the cluster shown in the figure, the validation matrix Ω is

$$\Omega = \begin{bmatrix} 1 & 1 & 0 \\ 1 & 1 & 1 \\ 1 & 0 & 1 \end{bmatrix}$$

Note that all the elements in the first column of Ω are 1, because any detection can be clutter or false alarm. One important step in the logic of joint probabilistic data association (JPDA) is to obtain all the feasible independent joint events in a cluster. Two assumptions for the feasible joint events are:

- A detection cannot be emitted by more than one track.
- A track cannot be detected more than once by the sensor during a single scan.

Based on these two assumptions, feasible joint events (FJEs) can be formulated. Each FJE is mapped to an FJE matrix Ω_p from the initial validation matrix Ω . For example, with the validation matrix Ω , eight FJE matrices can be obtained:

$$\begin{aligned} \Omega_1 &= \begin{bmatrix} 1 & 0 & 0 \\ 1 & 0 & 0 \\ 1 & 0 & 0 \end{bmatrix}, \quad \Omega_2 = \begin{bmatrix} 0 & 1 & 0 \\ 1 & 0 & 0 \\ 1 & 0 & 0 \end{bmatrix}, \quad \Omega_3 = \begin{bmatrix} 1 & 0 & 0 \\ 0 & 1 & 0 \\ 1 & 0 & 0 \end{bmatrix}, \quad \Omega_4 = \begin{bmatrix} 1 & 0 & 0 \\ 0 & 0 & 1 \\ 1 & 0 & 0 \end{bmatrix} \\ \Omega_5 &= \begin{bmatrix} 0 & 1 & 0 \\ 0 & 0 & 1 \\ 1 & 0 & 0 \end{bmatrix}, \quad \Omega_6 = \begin{bmatrix} 1 & 0 & 0 \\ 1 & 0 & 0 \\ 0 & 0 & 1 \end{bmatrix}, \quad \Omega_7 = \begin{bmatrix} 0 & 1 & 0 \\ 1 & 0 & 0 \\ 0 & 0 & 1 \end{bmatrix}, \quad \Omega_8 = \begin{bmatrix} 1 & 0 & 0 \\ 0 & 1 & 0 \\ 0 & 0 & 1 \end{bmatrix} \end{aligned}$$

As a direct consequence of the two assumptions, the Ω_p matrices have exactly one "1" value per row. Also, except for the first column which maps to clutter, there can be at most one "1" per column. When the number of connected tracks grows in a cluster, the number of FJE increases rapidly. The `jpdaEvents` function uses an efficient depth-first search algorithm to generate all the feasible joint event matrices.

Track Structure

The fields of a track structure are:

Field	Definition
SourceIndex	Unique source index used to distinguish tracking sources in a multiple tracker environment.
TrackID	Unique track identifier used to distinguish multiple tracks.
BranchID	Unique track branch identifier used to distinguish multiple track branches.
UpdateTime	Time at which the track is updated. Units are in seconds.
Age	Number of times the track survived.
State	Value of state vector at the update time.
StateCovariance	Uncertainty covariance matrix.

Field	Definition
TrackLogic	Confirmation and deletion logic type, returned as 'History' or 'Integrated'.
TrackLogicState	The current state of the track logic type. Based on the logic type TrackLogic, the logic state is returned as: <ul style="list-style-type: none"> 'History' - A 1-by-K logical array, where K is the number of latest track logical states recorded. In the array, 1 denotes hit and 0 denote miss. 'Integrated' - A nonnegative scalar. The scalar represents the integrated probability of existence of the track. The default value is 0.5.
IsConfirmed	Confirmation status. This field is <code>true</code> if the track is confirmed to be a real target.
IsCoasted	Coasting status. This field is <code>true</code> if the track is updated without a new detection.
IsSelfReported	Indicate if the track is reported by the tracker. This field is used in a track fusion environment. It is returned as <code>true</code> by default.
ObjectClassID	Integer value representing the object classification. The value 0 represents an unknown classification. Nonzero classifications apply only to confirmed tracks.
ObjectAttributes	Additional information of the track.

Extended Capabilities

C/C++ Code Generation

Generate C and C++ code using Simulink® Coder™.

See Also

Blocks

Global Nearest Neighbor Multi Object Tracker

Functions

`correctjpd` | `getTrackPositions` | `getTrackVelocities` | `jpdEvents` | `predictTracksToTime`

Objects

`objectDetection` | `objectTrack` | `staticDetectionFuser` | `trackHistoryLogic` | `trackerGNN` | `trackerTOMHT` | `trackingABF` | `trackingCKF` | `trackingEKF` | `trackingIMM` | `trackingKF` | `trackingUKF`

Blocks

Global Nearest Neighbor Multi Object Tracker | Track-Oriented Multi-Hypothesis Tracker | Track-To-Track Fuser

Topics

“Introduction to Multiple Target Tracking”

“Introduction to Assignment Methods in Tracking Systems”

“Create Nonvirtual Buses” (Simulink)

Introduced in R2019b

Track-Oriented Multi-Hypothesis Tracker

Track-Oriented Multi-Hypothesis Tracker

Library: Sensor Fusion and Tracking Toolbox / Multi-Object Tracking Algorithms



Description

The Track-Oriented Multi-Hypothesis Tracker block processes detections of multi targets from multiple sensors. The tracker block initializes, confirms, predicts, corrects, and deletes tracks. Inputs to the tracker block are detection reports generated by `objectDetection`, `fusionRadarSensor`, `irSensor`, or `sonarSensor` objects. The tracker block estimates the state vector and state vector covariance matrix for each track. The tracker assigns detections based on a track-oriented, multi-hypothesis approach.

Any new track starts in a *tentative* state. If enough detections are assigned to a tentative track, its status changes to *confirmed*. If the detection already has a known classification (the `ObjectClassID` field of the returned track is nonzero), that track is confirmed immediately. When a track is confirmed, the multi-object tracker considers the track to represent a physical object. If detections are not assigned to the track within a specifiable number of updates, the track is deleted. For an overview of how the tracker functions, see “Algorithms” on page 4-103.

Ports

Input

Detections – Detection list

Simulink bus containing MATLAB structure

Detection list, specified as a Simulink bus containing a MATLAB structure. The structure has the form:

Field	Description	Type
NumDetections	Number of detections	Integer
Detections	Object detections	Array of <code>objectDetection</code> structures. The first <code>NumDetections</code> of these detections are actual detections.

The fields of the detections structure are:

Field	Description	Type
Time	Measurement time	Single or Double
Measurement	Object measurements	Single or Double

Field	Description	Type
MeasurementNoise	Measurement noise covariance matrix	Single or Double
SensorIndex	Unique ID of the sensor	Single or Double
ObjectClassID	Object classification ID	Single or Double
MeasurementParameters	Parameters used by initialization functions of tracking filters	Simulink Bus
ObjectAttributes	Additional information passed to tracker	Simulink Bus

See `objectDetection` for a more detailed explanation of these fields.

Note The object detection structure contains a `Time` field. The time tag of each object detection must be less than or equal to the time at the current invocation of the block. The time tag must also be greater than the update time specified in the previous invocation of the block.

Prediction Time – Track update time

real scalar

Track update time, specified as a real scalar in seconds. The tracker updates all tracks to this time. The update time must always increase with each invocation of the block. The update time must be at least as large as the largest `Time` specified in the **Detections** input port.

If the port is not enabled, the simulation clock managed by Simulink determines the update time.

Dependencies

To enable this port, on the **Port Setting** tab, set **Prediction time source** to `Input` port.

Cost Matrix – Cost matrix

real-valued N -by- M matrix

Cost matrix, specified as a real-valued N -by- M matrix, where N is the number of branches and M is the number of current detections.

The rows of the cost matrix must be in the same order as the list of branches. Branches are ordered as they appear in the list of branches from the **All Branches** output port on the previous invocation of the block. The columns correspond to the detections.

In the first update to the tracker, or if the tracker has no previous tracks, assign the cost matrix a size of $[0, N]$. The cost must be calculated so that lower costs indicate a higher likelihood that the tracker assigns a detection to a track. To prevent certain detections from being assigned to certain tracks, use `Inf`.

If this port is not enabled, the filter initialized by the **Filter initialization function** calculates the cost matrix using the distance method.

Dependencies

To enable this port, on the **Port Setting** tab, select **Enable cost matrix input**.

Detectable BranchIDs — Detectable Branch IDsreal-valued M -by-1 vector | real-valued M -by-2 matrix

Detectable branch IDs, specified as a real-valued M -by-1 vector or M -by-2 matrix. Detectable branches are branches that the sensors expect to detect. The first column of the matrix contains a list of branch IDs that the sensors report as detectable. The optional second column enables you to add the detection probability for each branch. Branches are listed in the **All Branches** output from the previous invocation of the block.

Tracks whose identifiers are not included in **Detectable BranchIDs** are considered undetectable. The track deletion logic does not count the lack of detection as a "missed detection" for track deletion purposes.

If this port is not enabled, the tracker assumes all tracks to be detectable at each invocation of the block.

Dependencies

To enable this port, on the **Port Setting** tab, select **Enable detectable branch IDs input**.

State Parameters — Track state parameters

Simulink bus containing MATLAB structure

Track state parameters, specified as a Simulink bus containing a MATLAB structure. The structure has the form:

Field	Description
NumParameters	Number of non-default state parameters, specified as a nonnegative integer
Parameters	Array of state parameter structures

The block uses the value of the `Parameters` field for the `StateParameters` field of the generated tracks. You can use these parameters to define the reference frame in which the track is reported or other desirable attributes of the generated tracks.

For example, you can use the following structure to define a rectangular reference frame whose origin position is at $[10 \ 10 \ 0]$ meters and whose origin velocity is $[2 \ -2 \ 0]$ meters per second with respect to the scenario frame.

Field Name	Value
Frame	"Rectangular"
Position	$[10 \ 10 \ 0]$
Velocity	$[2 \ -2 \ 0]$

Dependencies

To enable this port, in the **Tracker Configuration** tab, select the **Update track state parameters with time** parameter.

Output**Confirmed Tracks — Confirmed tracks**

Simulink bus containing MATLAB structure

Confirmed tracks, returned as a Simulink bus containing a MATLAB structure. The structure has the form:

Field	Description
NumTracks	Number of tracks
Tracks	Array of track structures of a length set by the Maximum number of tracks parameter. Only the first NumTracks of these are actual tracks.

The fields of the track structure are shown in “Track Structure” on page 4-106.

A track is confirmed if it satisfies the threshold specified in the **Confirmation threshold** parameter under the **Track Logic** tab.

Tentative Tracks – Tentative tracks

Simulink bus containing MATLAB structure

Tentative tracks, returned as a Simulink bus containing a MATLAB structure. A track is tentative before it is confirmed.

The fields of the track structure are shown in “Track Structure” on page 4-106.

Dependencies

To enable this port, on the **Port Setting** tab, select **Enable tentative tracks output**.

All Tracks – Confirmed and tentative tracks

Simulink bus containing MATLAB structure

Combined list of confirmed and tentative tracks, returned as a Simulink bus containing a MATLAB structure.

The fields of the track structure are shown in “Track Structure” on page 4-106.

Dependencies

To enable this port, on the **Port Setting** tab, select **Enable all tracks output**.

Info – Additional information for analyzing track updates

Simulink bus containing MATLAB structure

Additional information for analyzing track updates, returned as a Simulink bus containing a MATLAB structure.

This table shows the fields of the info structure:

Field	Description
BranchIDsAtStepBeginning	Branch IDs when the update began.
CostMatrix	Cost of assignment matrix.
Assignments	Assignments returned from the assignTOMHT function.

UnassignedTracks	IDs of unassigned branches returned from the tracker.
UnassignedDetections	IDs of unassigned detections returned from the tracker.
InitialBranchHistory	Branch history after branching and before pruning.
InitialBranchScores	Branch scores before pruning.
KeptBranchHistory	Branch history after initial pruning.
KeptBranchScores	Branch scores after initial pruning.
Clusters	Logical array mapping branches to clusters. Branches belong in the same cluster if they share detections in their history or belong to the same track either directly or through other branches.
TrackIncompatibility	Branch incompatibility matrix. The (i, j) element is true if the i -th and j -th branches have shared detections in their history or belong to the same track.
GlobalHypotheses	Logical matrix mapping branches to global hypotheses. Compatible branches can belong in the same hypotheses.
GlobalHypScores	Total score of global hypotheses.
PrunedBranches	Logical array of branches that the <code>pruneTrackBranches</code> function determines to prune.
GlobalBranchProbabilities	Global probability of each branch existing in the global hypotheses.
BranchesDeletedByPruning	Branches deleted by the tracker.
BranchIDsAtStepEnd	Branch IDs when the update ended.

Dependencies

To enable this port, on the **Port Setting** tab, select **Enable information output**.

All Branches – All branches

Simulink bus containing MATLAB structure

All branches, returned as a Simulink bus containing a MATLAB structure.

The fields of the branch structure are the same as the “Track Structure” on page 4-106.

Dependencies

To enable this port, on the **Port Setting** tab, select **Enable all branches output**.

Parameters

Tracker Management

Tracker identifier — Unique tracker identifier

0 (default) | nonnegative integer

Unique tracker identifier, specified as a nonnegative integer. This parameter is passed as the `SourceIndex` in the tracker outputs, and distinguishes tracks that come from different trackers in a multiple-tracker system. You must specify this property as a positive integer to use the track outputs as inputs to a `trackFuser` object.

Example: 1

Filter initialization function — Filter initialization function

@initcvkf (default) | function handle | character vector

Filter initialization function, specified as a function handle or as a character vector containing the name of a filter initialization function. The tracker uses a filter initialization function when creating new tracks.

Sensor Fusion and Tracking Toolbox provides many initialization functions that are compatible with this block.

Initialization Function	Function Definition
<code>initcvabf</code>	Initialize constant-velocity alpha-beta filter
<code>initcaabf</code>	Initialize constant-acceleration alpha-beta filter
<code>initcvkf</code>	Initialize constant-velocity extended Kalman filter.
<code>initcackf</code>	Initialize constant-acceleration cubature filter.
<code>initctckf</code>	Initialize constant-turn-rate cubature filter.
<code>initcvckf</code>	Initialize constant-velocity cubature filter.
<code>initcapf</code>	Initialize constant-acceleration particle filter.
<code>initctpf</code>	Initialize constant-turn-rate particle filter.
<code>initcvpf</code>	Initialize constant-velocity particle filter.
<code>initcvkf</code>	Initialize constant-velocity linear Kalman filter.
<code>initcvukf</code>	Initialize constant-velocity unscented Kalman filter.
<code>initcaekf</code>	Initialize constant-acceleration extended Kalman filter.
<code>initcakf</code>	Initialize constant-acceleration linear Kalman filter.
<code>initcaukf</code>	Initialize constant-acceleration unscented Kalman filter.
<code>initctekf</code>	Initialize constant-turn-rate extended Kalman filter.
<code>initctukf</code>	Initialize constant-turn-rate unscented Kalman filter.

Initialization Function	Function Definition
<code>initcvmscekf</code>	Initialize constant-velocity modified spherical coordinates extended Kalman filter.
<code>initrpekf</code>	Initialize constant-velocity range-parametrized extended Kalman filter.
<code>initapekf</code>	Initialize constant-velocity angle-parametrized extended Kalman filter.
<code>initekfimm</code>	Initialize tracking IMM filter.

You can also write your own initialization function. The function must have the following syntax:

```
filter = filterInitializationFcn(detection)
```

The input to this function is a detection report like those created by the `objectDetection` object. The output of this function must be a filter object: `trackingKF`, `trackingEKF`, `trackingUKF`, `trackingCKF`, `trackingPF`, `trackingMSCEKF`, `trackingGSF`, `trackingIMM`, or `trackingABF`.

To guide you in writing this function, you can examine the details of the supported functions from within MATLAB. For example:

```
type initcvekf
```

Data Types: `function_handle` | `char`

Threshold for assigning detections to tracks – Threshold for assigning detections to tracks

`30*[0.3 0.7 1 Inf]` (default) | positive scalar | 1-by-3 vector of positive values | 1-by-4 vector of positive values

Threshold for assigning detections to tracks, specified as a positive scalar, a 1-by-3 vector of non-decreasing positive values, $[C_1, C_2, C_3]$, or a 1-by-4 vector of non-decreasing positive values, $[C_1, C_2, C_3, C_4]$. If specified as a scalar, the specified value, *val*, will be expanded to $[0.3, 0.7, 1, \text{Inf}] * \text{val}$. If specified as $[C_1, C_2, C_3]$, it will be expanded as $[C_1, C_2, C_3, \text{Inf}]$.

The thresholds control (1) the assignment of a detection to a track, (2) the creation of a new branch from a detection, and (3) the creation of a new branch from an unassigned track. The threshold values must satisfy: $C_1 \leq C_2 \leq C_3 \leq C_4$.

- C_1 defines a distance such that if a track has an assigned detection with lower distance than C_1 , the track is no longer considered unassigned and does not create an unassigned track branch.
- C_2 defines a distance such that if a detection has been assigned to a track with lower distance than C_2 , the detection is no longer considered unassigned and does not create a new track branch.
- C_3 defines the maximum distance for assigning a detection to a track.
- C_4 defines combinations of track and detection for which an accurate normalized cost calculation is performed. Initially, the tracker executes a coarse estimation for the normalized distance between all the tracks and detections. The tracker only calculates the accurate normalized distance for the combinations whose coarse normalized distance is less than C_4 .

Tips:

- Increase the value of C_3 if there are detections that should be assigned to tracks but are not. Decrease the value if there are detections that are assigned to tracks they should not be assigned to (too far away).
- Increasing the values C_1 and C_2 helps control the number of track branches that are created. However, doing so reduces the number of branches (hypotheses) each track has.
- Increase the value of C_4 if there are combinations of track and detection that should be calculated for assignment but are not. Decrease it if cost calculation takes too long.

Data Types: `single` | `double`

Maximum number of tracks — Maximum number of tracks

100 (default) | positive integer

Maximum number of tracks that the block can maintain, specified as a positive integer.

Maximum number of sensors — Maximum number of sensors

20 (default) | positive integer

Maximum number of sensors that can be connected to the tracker, specified as a positive integer. `MaxNumSensors` must be greater than or equal to the largest value of `SensorIndex` found in all the detections used to update the tracker. `SensorIndex` is one of the properties of an `objectDetection` object. The block's `MaxNumSensors` property determines how many sets of `ObjectAttributes` fields each output track can have.

Out-of-sequence measurements handling — Out-of-sequence measurements handling

Terminate (default) | neglect

Out-of-sequence measurements handling, specified as `Terminate` or `neglect`. Each detection has a timestamp associated with it, t_d , and the tracker block has its own timestamp, t_t , which is updated in each invocation. The tracker block considers a measurement as an OOSM if $t_d < t_t$.

When the parameter is specified as:

- `Terminate` — The block stops running when it encounters any out-of-sequence measurements.
- `Neglect` — The block neglects any out-of-sequence measurements and continues to run.

Track state parameters — Parameters of track state reference frame

structure | structure array

Parameters of the track state reference frame, specified as a structure or a structure array. The block passes the value of this parameter to the `StateParameters` field of the generated tracks. You can use these parameters to define the reference frame in which the track is reported or other desirable attributes of the generated tracks.

For example, you can use the following structure to define a rectangular reference frame whose origin position is at `[10 10 0]` meters and whose origin velocity is `[2 -2 0]` meters per second with respect to the scenario frame.

Field Name	Value
Frame	"Rectangular"
Position	[10 10 0]
Velocity	[2 -2 0]

You can update the track state parameters through the **State Parameters** input port by selecting the **Update track state parameters with time** parameter.

Data Types: `struct`

Update track state parameters with time — Update track state parameters with time
`off (default) | on`

Select this parameter to enable the input port for track state parameters through the **State Parameters** input port.

Track output method — Track output method
`'Tracks' (default) | 'Hypothesis' | 'Clusters'`

Track output method, specified as `'Tracks'`, `'Hypothesis'`, or `'Clusters'`.

- `'Tracks'` - Output the centroid of each track based on its track branches.
- `'Hypothesis'` - Output branches that are in certain hypotheses. If you choose this option, list the hypotheses to output using the `HypothesesToOutput` property.
- `'Clusters'` - Output the centroid of each cluster. Similar to the `'Tracks'` output, but includes all tracks within a cluster.

Data Types: `char`

Simulate using — Type of simulation to run
`Interpreted Execution (default) | Code Generation`

- `Interpreted execution` — Simulate the model using the MATLAB interpreter. This option shortens startup time. In the `Interpreted execution` mode, you can debug the source code of the block.
- `Code generation` — Simulate the model using generated C code. The first time you run a simulation, Simulink generates C code for the block. The C code is reused for subsequent simulations as long as the model does not change. This option requires additional startup time.

Hypotheses Management

Maximum number of hypotheses to be maintained — Maximum number of hypotheses to be maintained
`5 (default) | positive integer`

Maximum number of hypotheses maintained by the tracks in cases of ambiguity, specified as a positive integer. Larger values increase the computational load.

Example: 10

Data Types: `single` | `double`

Maximum number of track branches per track — Maximum number of track branches per track
`3 (default) | positive integer`

Maximum number of track branches (hypotheses) allowed for each track, specified as a positive integer. Larger values increase the computational load.

Data Types: `single` | `double`

Maximum number of scans maintained in the branch history — Maximum number of scans maintained in the branch history

4 (default) | positive integer

Maximum number of scans maintained in the branch history, specified as a positive integer. The number of track history scans is typically from 2 through 6. Larger values increase the computational load.

Data Types: single | double

Minimum probability required to keep a branch — Minimum probability required to keep a branch

.001 (default) | positive scalar

Minimum probability required to keep a track branch, specified as a positive scalar less than one. Any track with probability lower than the specified probability is pruned. Typical values are 0.001 to 0.005.

Example: .003

Data Types: single | double

N-scan pruning method — N-scan pruning method

'None' (default) | 'Hypothesis'

N-scan pruning method, specified as 'None' or 'Hypothesis'. In N-scan pruning, branches that belong to the same track are pruned (deleted) if, in the N-scans history, they contradict the most likely branch for the same track. The most-likely branch is defined in one of two ways:

- 'None' - No N-scan pruning is performed.
- 'Hypothesis' - The chosen branch is in the most likely hypothesis.

Example: 'Hypothesis'

Track Logic**Confirmation threshold [positive scalar] — Minimum score required to confirm track**

20 (default) | positive scalar

Minimum score required to confirm a track, specified as a positive scalar. Any track with a score higher than this threshold is confirmed.

Example: 12

Data Types: single | double

Deletion threshold [negative scalar] — Maximum score drop for track deletion

-7 (default) | scalar

The maximum score drop before a track is deleted, specified as a scalar. Any track with a score that falls by more than this parameter from the maximum score is deleted. Deletion threshold is affected by the probability of a false alarm.

Example: -1

Data Types: single | double

Probability of detection used for track score – Probability of detection used for track score

0.9 (default) | positive scalar between 0 and 1

Probability of detection, specified as a positive scalar between 0 and 1. This property is used to compute track score.

Example: 0.5

Data Types: single | double

Rate of false positives used for track score – Probability of false alarm used for track score

1e-6 (default) | scalar

The probability of false alarm, specified as a scalar. This property is used to compute track score.

Example: 1e-5

Data Types: single | double

Volume of the sensor's detection bin – Volume of sensor measurement bin

1 (default) | positive scalar

The volume of a sensor measurement bin, specified as a positive scalar. For example, if a radar produces a 4-D measurement, which includes azimuth, elevation, range, and range rate, the 4-D volume is defined by the radar angular beam width, the range bin width, and the range-rate bin width. Volume is used in calculating the track score when initializing and updating a track.

Example: 1.5

Data Types: single | double

Rate of new tracks per unit volume – Rate of new tracks per unit volume

1 (default) | positive scalar

The rate of new tracks per unit volume, specified as a positive scalar. The parameter is used in calculating the track score during track initialization.

Example: 2.5

Data Types: single | double

Port Setting**Prediction time source – Source of prediction time**

Auto (default) | Input port

Source for prediction time, specified as Input port or Auto. Select Input port to input an update time by using the **Prediction Time** input port. Otherwise, the simulation clock managed by Simulink determines the update time.

Enable cost matrix input – Enable input port for cost matrix

off (default) | on

Select this parameter to enable the input of a cost matrix by using the **Cost Matrix** input port.

Enable detectable branch IDs input – Enable detectable branch IDs input

off (default) | on

Select this parameter to enable the **Detectable branch IDs** input port.

Enable tentative tracks output — Enable output port for tentative tracks

off (default) | on

Select this parameter to enable the output of tentative tracks through the **Tentative Tracks** output port.

Enable all tracks output — Enable output port for all tracks

off (default) | on

Select this parameter to enable the output of all the tracks through the **All Tracks** output port.

Enable information output — Enable output port for analysis information

off (default) | on

Select this parameter to enable the output port for analysis information through the **Info** output port.

Enable all branches output — Enable output port for all branches

off (default) | on

Select this parameter to enable the output of all the branches through the **All Branches** output port.

Source of output bus name — Source of output track bus name

Auto (default) | Property

Source of the output track bus name, specified as:

- **Auto** — The block automatically creates an output track bus name.
- **Property** — Specify the output track bus name by using the **Specify an output bus name** parameter.

Source of output info bus name — Source of output information bus name

Auto (default) | Property

Source of the output info bus name, specified as:

- **Auto** — The block automatically creates an output info bus name.
- **Property** — Specify the output info bus name by using the **Specify an output info bus name** parameter.

Dependencies

To enable this parameter, on the **Port Setting** tab, select **Enable information output**.

Algorithms

Tracker Logic Flow

When you process detections using the tracker, track creation and management follow these steps.

- 1 The tracker attempts to assign detections to existing tracks.
- 2 The track allows for multiple hypotheses about the assignment of detections to tracks.

- 3** Unassigned detections result in the creation of new tracks.
- 4** Assignments of detections to tracks create branches for the assigned tracks.
- 5** Tracks with no assigned detections are coasted (predicted).
- 6** All track branches are scored. Branches with low initial scores are pruned.
- 7** Clusters of branches that share detections (incompatible branches) in their history are generated.
- 8** Global hypotheses of compatible branches are formulated and scored.
- 9** Branches are scored based on their existence in the global hypotheses. Low-scored branches are pruned.
- 10** Additional pruning is performed based on N-scan history.
- 11** All tracks are corrected and predicted to the input time.

Assignment Thresholds for Multi-Hypothesis Tracker

Three assignment thresholds, C_1 , C_2 , and C_3 , control (1) the assignment of a detection to a track, (2) the creation of a new branch from a detection, and (3) the creation of a new branch from an unassigned track. The threshold values must satisfy: $C_1 \leq C_2 \leq C_3$.

If the cost of an assignment is $C = \text{costmatrix}(i, j)$, the following hypotheses are created based on comparing the cost to the values of the assignment thresholds. Below each comparison, there is a list of the possible hypotheses.

- Track
- Detection

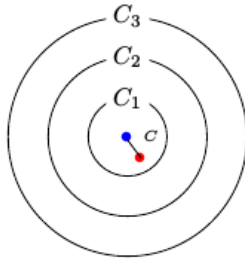

$$C \leq C_1$$

Single Hypothesis

- (1) Detection is assigned to track. A branch is created updating the track with this detection.

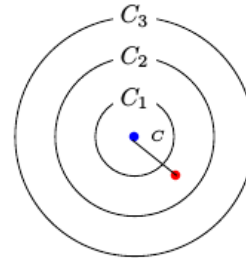

$$C_1 < C \leq C_2$$

Two Hypotheses

- (1) Detection is assigned to track. A branch is created updating the track with this detection.
 (2) Track is not assigned to detection and is coasted.

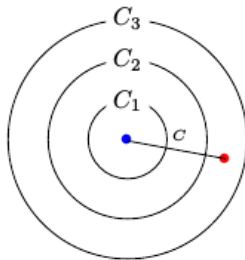

$$C_2 < C \leq C_3$$

Three Hypotheses

- (1) Detection is assigned to track. A branch is created updating the track with this detection.
 (2) Track is not assigned to detection and is coasted.
 (3) Detection is not assigned and creates a new track (branch).

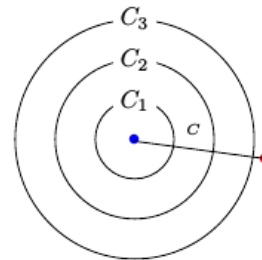

$$C_3 < C$$

Single Hypothesis

- (1) Detection is not assigned and creates a new track (branch).

Tips:

- Increase the value of C_3 if there are detections that should be assigned to tracks but are not. Decrease the value if there are detections that are assigned to tracks they should not be assigned to (too far away).
- Increasing the values C_1 and C_2 helps control the number of track branches that are created. However, doing so reduces the number of branches (hypotheses) each track has.
- To allow each track to be unassigned, set $C_1 = 0$.
- To allow each detection to be unassigned, set $C_2 = 0$.

Data Precision

All numeric inputs can be single or double precision, but they all must have the same precision.

Track Structure

The fields of a track structure are:

Field	Definition
SourceIndex	Unique source index used to distinguish tracking sources in a multiple tracker environment.
TrackID	Unique track identifier used to distinguish multiple tracks.
BranchID	Unique track branch identifier used to distinguish multiple track branches.
UpdateTime	Time at which the track is updated. Units are in seconds.
Age	Number of times the track survived.
State	Value of state vector at the update time.
StateCovariance	Uncertainty covariance matrix.
TrackLogic	Confirmation and deletion logic type, returned as 'History' or 'Integrated'.
TrackLogicState	The current state of the track logic type. Based on the logic type <code>TrackLogic</code> , the logic state is returned as: <ul style="list-style-type: none"> 'History' - A 1-by-K logical array, where K is the number of latest track logical states recorded. In the array, 1 denotes hit and 0 denote miss. 'Integrated' - A nonnegative scalar. The scalar represents the integrated probability of existence of the track. The default value is 0.5.
IsConfirmed	Confirmation status. This field is <code>true</code> if the track is confirmed to be a real target.
IsCoasted	Coasting status. This field is <code>true</code> if the track is updated without a new detection.
IsSelfReported	Indicate if the track is reported by the tracker. This field is used in a track fusion environment. It is returned as <code>true</code> by default.
ObjectClassID	Integer value representing the object classification. The value 0 represents an unknown classification. Nonzero classifications apply only to confirmed tracks.
ObjectAttributes	Additional information of the track.

References

- [1] Werthmann, J. R. "Step-by-Step Description of a Computationally Efficient Version of Multiple Hypothesis Tracking." In *International Society for Optics and Photonics*, Vol. 1698, pp. 228-301, 1992.

[2] Blackman, S., and R. Popoli. *Design and Analysis of Modern Tracking Systems*. Artech House Radar Library, Boston, 1999.

Extended Capabilities

C/C++ Code Generation

Generate C and C++ code using Simulink® Coder™.

See Also

Functions

`getTrackPositions` | `getTrackVelocities`

Objects

`fusionRadarSensor` | `irSensor` | `objectDetection` | `objectTrack` | `sonarSensor` | `trackerGNN` | `trackingABF` | `trackingCKF` | `trackingEKF` | `trackingGSF` | `trackingIMM` | `trackingKF` | `trackingMSCEKF` | `trackingPF` | `trackingUKF`

Blocks

Global Nearest Neighbor Multi Object Tracker | Joint Probabilistic Data Association Multi Object Tracker | Track-To-Track Fuser

Topics

“Introduction to Multiple Target Tracking”

“Introduction to Assignment Methods in Tracking Systems”

“Create Nonvirtual Buses” (Simulink)

Introduced in R2020a

Track Concatenation

Concatenate tracks

Library: Sensor Fusion and Tracking Toolbox / Utilities



Description

The Track Concatenation block concatenates track buses originating from multiple sources into a single list of object tracks. The sources to this block must all use the `objectDetection` format, and can be sensors, trackers, other track concatenation blocks, or other track-to-track fusion blocks. Use this block to concatenate tracks from multiple sources before passing them into the Track-To-Track Fuser block.

Ports

Input

In1, In2, ..., InN — Tracks to combine

Simulink buses containing MATLAB structures

Tracks to combine, where each track is a Simulink bus containing a MATLAB structure. See “Create Nonvirtual Buses” (Simulink) for more details.

You can find the definitions of the track lists in the **Confirmed Tracks** output port descriptions of the tracker blocks, such as the Global Nearest Neighbor Multi Object Tracker block.

By default, the block includes two ports for input detections. To add more ports, use the **Number of input sensors to combine** parameter.

Output

Out — Combined tracks

Simulink bus containing MATLAB structure

Combined tracks from all input buses, returned as a Simulink bus containing a MATLAB structure. See “Create Nonvirtual Buses” (Simulink). You can find the definitions of the track lists in the **Confirmed Tracks** output port descriptions of the tracker blocks, such as the Global Nearest Neighbor Multi Object Tracker block.

Parameters

Number of input tracks to combine — Number of input track ports

2 (default) | positive integer

Number of input track ports, specified as a positive integer. The input ports labeled **In1, In2, ..., InN**, where N is the value set by this parameter.

Data Types: double

Source of output bus name — Source of output bus name

Auto (default) | Property

Source of the output bus name, specified as Auto or Property.

- If you select Auto, the block automatically generates a bus name.
- If you select Property, specify the bus name using the **Specify an output bus name** parameter.

Specify an output bus name — Name of output bus

BusTrackConcatenation

Specify a name for the output bus.

Dependencies

To enable this parameter, set the **Source of output bus name** parameter to Property.

Simulate using — Type of simulation to run

Interpreted execution (default) | Code generation

- **Interpreted execution** — Simulate the model using the MATLAB interpreter. This option shortens startup time. In Interpreted execution mode, you can debug the source code of the block.
- **Code generation** — Simulate the model using generated C/C++ code. The first time you run a simulation, Simulink generates C/C++ code for the block. The C code is reused for subsequent simulations as long as the model does not change. This option requires additional startup time.

Extended Capabilities**C/C++ Code Generation**

Generate C and C++ code using Simulink® Coder™.

See Also

Global Nearest Neighbor Multi Object Tracker | Joint Probabilistic Data Association Multi Object Tracker | Track-Oriented Multi-Hypothesis Tracker | Track-To-Track Fuser

Topics

“Create Nonvirtual Buses” (Simulink)

Introduced in R2021a

Track-To-Track Fuser

Track-to-Track Fusion

Library: Sensor Fusion and Tracking Toolbox / Multi-Object Tracking Algorithms



Description

The Track-to-Track Fuser Simulink block is a multi-source, multi-object, track-level fuser that uses the global nearest neighbor (GNN) association to maintain a single hypothesis about the tracks it fuses. The inputs to the block are tracks from sources that already track multiple objects, like multi-object tracker blocks or other track-to-track fuser blocks. The input tracks are called source or local tracks, whereas the tracks maintained in the fuser are called central tracks.

Ports

Input

Tracks — Track list

Simulink bus containing MATLAB structure

Track list, specified as a Simulink bus containing a MATLAB structure. The structure has the form:

Field	Description
NumTracks	Number of tracks
Tracks	Array of track structures

The fields of the track structure are shown in “Track Structure” on page 4-121.

Prediction Time — Track update time

real scalar

Track update time, specified as a real scalar in seconds. The fuser updates all tracks to this time. The update time must increase with each invocation of the block. The update time must be at least as large as the largest UpdateTime specified in the **Tracks** input port.

If this port is not enabled, the simulation clock managed by Simulink determines the update time.

Dependencies

To enable this port, on the **Port Setting** tab, set **Prediction time source** to Input port.

Source Configurations — Source configuration list

Simulink bus containing MATLAB structure

Source configuration list, specified as a Simulink bus containing a MATLAB structure. The structure has the form:

Field	Description
NumConfigurations	Number of non-default source configurations. The field value must be less than the value specified in the Maximum number of source configurations parameter.
Configurations	Array of source configuration structures.

The fields of the source configuration structure are:

Field Name	Description
SourceIndex	Unique index for the source system, specified as a positive integer.
IsInternalSource	Indicate if the source is internal to the fuser, specified as <code>true</code> or <code>false</code> . An internal source is a source that the fuser directly fuses tracks from even if the tracks are not self reported. For example, if the fuser is at the vehicle level, a tracking radar installed on the associated vehicle is considered internal, while another vehicle that reports fused tracks is considered external.
IsInitializingCentralTracks	Indicate if the source can initialize a central track in the fuser, specified as <code>true</code> or <code>false</code> . A central track is a track maintained in the fuser.
LocalToCentralTransformFcn	Function to transform a track from local to central state space, specified as a function handle. For example, <code>@track(track)</code> performs no transformation.
CentralToLocalTransformFcn	Function to transform a track from central to local state space, specified as a function handle. For example, <code>@track(track)</code> performs no transformation.

Dependencies

To enable this port, on the **Fuser Management** tab, select the **Update source configurations with time** parameter.

State Parameters – Track state parameters

Simulink bus containing MATLAB structure

Track state parameters, specified as a Simulink bus containing a MATLAB structure. The structure has the form:

Field	Description
NumParameters	Number of non-default state parameters, specified as a nonnegative integer
Parameters	Array of state parameter structures

The block uses the value of the **Parameters** field for the **StateParameters** field of the generated tracks. You can use these parameters to define the reference frame in which the track is reported or other desirable attributes of the generated tracks.

For example, you can use the following structure to define a rectangular reference frame whose origin position is at [10 10 0] meters and whose origin velocity is [2 -2 0] meters per second with respect to the scenario frame.

Field Name	Value
Frame	"Rectangular"
Position	[10 10 0]
Velocity	[2 -2 0]

Dependencies

To enable this port, in the **Tracker Configuration** tab, select the **Update track state parameters with time** parameter.

Output

Confirmed Tracks – Confirmed tracks

Simulink bus containing MATLAB structure

Confirmed tracks, returned as a Simulink bus containing a MATLAB structure. The structure has the form:

Field	Description
NumTracks	Number of tracks.
Tracks	Array of track structures of a length set by the Maximum number of central tracks parameter. Only the first NumTracks of these are actual tracks.

The fields of the track structure are shown in “Track Structure” on page 4-121.

A track is confirmed if it satisfies the threshold specified in the **Confirmation threshold** parameter on the **Tracks** tab.

Tentative Tracks – Tentative tracks

Simulink bus containing MATLAB structure

Tentative tracks, returned as a Simulink bus containing a MATLAB structure. A track is tentative before it is confirmed.

The structure has the form:

Field	Description
NumTracks	Number of tracks.

Field	Description
Tracks	Array of track structures of a length set by the Maximum number of central tracks parameter. Only the first NumTracks of these are actual tracks.

The fields of the track structure are shown in “Track Structure” on page 4-121.

Dependencies

To enable this port, on the **Port Setting** tab, select **Enable tentative tracks output**.

All Tracks – Confirmed and tentative tracks

Simulink bus containing MATLAB structure

Combined list of confirmed and tentative tracks, returned as a Simulink bus containing a MATLAB structure.

The structure has the form:

Field	Description
NumTracks	Number of tracks.
Tracks	Array of track structures of a length set by the Maximum number of central tracks parameter. Only the first NumTracks of these are actual tracks.

The fields of the track structure are shown in “Track Structure” on page 4-121.

Dependencies

To enable this port, on the **Port Setting** tab, select **Enable all tracks output**.

Info – Additional information for analyzing track updates

Simulink bus containing MATLAB structure

Additional information for analyzing track updates, returned as a Simulink bus containing a MATLAB structure.

This table shows the fields of the info structure:

Field	Description
BranchIDsAtStepBeginning	Branch IDs when the update began.
CostMatrix	Cost of assignment matrix.
Assignments	Assignments returned from the assignTOMHT function.
UnassignedTracks	IDs of unassigned branches returned from the tracker.
UnassignedDetections	IDs of unassigned detections returned from the tracker.

InitialBranchHistory	Branch history after branching and before pruning.
InitialBranchScores	Branch scores before pruning.
KeptBranchHistory	Branch history after initial pruning.
KeptBranchScores	Branch scores after initial pruning.
Clusters	Logical array mapping branches to clusters. Branches belong in the same cluster if they share detections in their history or belong to the same track either directly or through other branches.
TrackIncompatibility	Branch incompatibility matrix. The (i, j) element is <code>true</code> if the i -th and j -th branches have shared detections in their history or belong to the same track.
GlobalHypotheses	Logical matrix mapping branches to global hypotheses. Compatible branches can belong in the same hypotheses.
GlobalHypScores	Total score of global hypotheses.
PrunedBranches	Logical array of branches that the <code>pruneTrackBranches</code> function determines to prune.
GlobalBranchProbabilities	Global probability of each branch existing in the global hypotheses.
BranchesDeletedByPruning	Branches deleted by the tracker.
BranchIDsAtStepEnd	Branch IDs when the update ended.

Dependencies

To enable this port, on the **Port Setting** tab, select **Enable information output**.

Parameters

Fuser Management

Fuser Index — Unique index for track fuser

1 (default) | positive integer

Unique index for the fuser, specified as a positive integer. Use this property to distinguish different fusers in a multiple-fuser environment.

Example: 2

Assignment algorithm name — Assignment algorithm

MatchPairs (default) | Munkres | Jonker-Volgenant | Auction | Custom

Assignment algorithm, specified as `MatchPairs`, `Munkres`, `Jonker-Volgenant`, `Auction`, or `Custom`. `Munkres` is the only assignment algorithm that guarantees an optimal solution, but it is also the slowest, especially for large numbers of detections and tracks. The other algorithms do not guarantee an optimal solution but can be faster for problems with 20 or more tracks and detections. Use `Custom` to define your own assignment function and specify its name in the **Name of 'Custom' assignment function** parameter.

Data Types: char

Name of 'Custom' assignment function — Name of 'Custom' assignment function
string | function handle

Name of 'Custom' assignment function, specified as a string or function handle. An assignment function must have the following syntax:

```
[assignments,unassignedCentral,unassignedLocal] = f(cost,costNonAssignment)
```

For an example of an assignment function and a description of its arguments, see `assignmunkres`.

Dependencies

To enable this property, set the **Assignment algorithm name** parameter to Custom.

Threshold for assigning source to central tracks — Threshold for assigning source to central tracks

[1 Inf]*30.0 (default) | positive scalar | 1-by-2 vector of positive values

Threshold for assigning source to central tracks, specified as a positive scalar or a 1-by-2 vector of form $[C_1 C_2]$, where $C_1 \leq C_2$. If specified as a scalar, the specified value, *val*, is expanded to $[val \text{ Inf}]$.

Initially, the fuser executes a coarse estimation for the normalized distance between all the source and central tracks. The fuser only calculates the accurate normalized distance for the source and central combinations whose coarse normalized distance is less than C_2 . Also, the fuser can only assign a local track to a central track if their accurate normalized distance is less than C_1 . See the `distance` function used with tracking filters for an explanation of the distance calculation.

Tip

- Increase the value of C_2 if there are combinations of source and central tracks that should be calculated for assignment but are not. Decrease it if the calculation takes too much time.
 - Increase the value of C_1 if there are source tracks that should be assigned to central tracks but are not. Decrease it if there are local tracks that are assigned to central tracks they should not be assigned to (too far away).
-

Maximum number of central tracks — Maximum number of central tracks

100 (default) | positive integer

Maximum number of central tracks that the tracker can maintain, specified as a positive integer.

Maximum number of source configurations — Maximum number of source configurations

20 (default) | positive integer

Maximum number of source configurations that the fuser can maintain, specified as a positive integer.

Source configurations — Configuration of source systems

struct('SourceIndex',1) (default) | array of source configuration structures

Configuration of source systems, specified as an array of source configuration structures. The fields of a source configuration structure are:

Field Name	Description
SourceIndex	Unique index for the source system, specified as a positive integer.
IsInternalSource	Indicate if the source is internal to the fuser, specified as <code>true</code> or <code>false</code> . An internal source is a source that the fuser directly fuses tracks from even if the tracks are not self reported. For example, if the fuser is at the vehicle level, a tracking radar installed on the associated vehicle is considered internal, while another vehicle that reports fused tracks is considered external.
IsInitializingCentralTracks	Indicate if the source can initialize a central track in the fuser, specified as <code>true</code> or <code>false</code> . A central track is a track maintained in the fuser.
LocalToCentralTransformFcn	Function to transform a track from local to central state space, specified as a function handle. For example, <code>@track(track)</code> performs no transformation.
CentralToLocalTransformFcn	Function to transform a track from central to local state space, specified as a function handle. For example, <code>@track(track)</code> performs no transformation.

Update source configurations with time — Update source configurations with time

off (default) | on

Select this parameter to enable the input of source configurations through the **Source configurations** input port.

Track state parameters — Parameters of track state reference frame

structure | structure array

Parameters of the track state reference frame, specified as a structure or a structure array. The block passes the value of this parameter to the `StateParameters` field of the generated tracks. You can use these parameters to define the reference frame in which the track is reported or other desirable attributes of the generated tracks.

For example, you can use the following structure to define a rectangular reference frame whose origin position is at `[10 10 0]` meters and whose origin velocity is `[2 -2 0]` meters per second with respect to the scenario frame.

Field Name	Value
Frame	"Rectangular"
Position	[10 10 0]
Velocity	[2 -2 0]

You can update the track state parameters through the **State Parameters** input port by selecting the **Update track state parameters with time** parameter.

Data Types: `struct`

Update track state parameters with time — Update track state parameters with time
off (default) | on

Select this parameter to enable the input port for track state parameters through the **State Parameters** input port.

Simulate using — Type of simulation to run
Interpreted execution (default) | Code Generation

Select a simulation type from these options:

- **Interpreted execution** — Simulate the model using the MATLAB interpreter. This option shortens startup time. In **Interpreted execution** mode, you can debug the source code of the block.
- **Code generation** — Simulate the model using generated C code. The first time you run a simulation, Simulink generates C code for the block. The C code is reused for subsequent simulations as long as the model does not change. This option requires additional startup time.

Tracks

Confirmation threshold [M N] — Threshold for central track confirmation
[2 3] (default) | positive integer | real-valued 1-by-2 vector of positive integers

Threshold for central track confirmation, specified as a positive integer, M , or a real-valued 1-by-2 vector of positive integers, $[M N]$. A central track is confirmed if it is assigned to local tracks at least M times in the last N updates. If specified as a positive integer, M , the confirmation threshold is expanded to $[M M]$.

Deletion threshold [P Q] — Threshold for central track deletion
[5 5] (default) | positive integer | real-valued 1-by-2 vector of positive integers

Threshold for central track deletion, specified as a positive integer, P , or a 1-by-2 vector of positive integers $[P Q]$ with $P \leq Q$. A central track is deleted if the track is not assigned to local tracks at least P times in the last Q updates. If specified a positive integer P , the confirmation threshold is expanded to $[P P]$.

Central track state size — Central track state size
6 (default) | positive integer

Central track state size, specified as a positive integer.

Central track object attributes — Central track object attributes
struct (default) | structure

Central track object attributes, specified as a structure. The tracker passes the value of this parameter to the `ObjectAttributes` field of the track output.

State transition function — State transition function
constvel (default) | function handle | string

State transition function, specified as a function handle or a string. This function calculates the state at time step k based on the state at time step $k-1$.

- If the **Enable additive process noise** parameter on the **Tracks** tab is enabled, the function must use the following syntax:

$$x(k) = f(x(k-1), dt)$$

where:

- $x(k)$ — The estimated state at time k , specified as a vector or a matrix. If specified as a matrix, then each column of the matrix represents one state vector.
- dt — The time step for prediction.
- If the **Enable additive process noise** parameter on the **Tracks** tab is not enabled, the function must use this syntax:

$$x(k) = f(x(k-1), w(k-1), dt)$$

where:

- $x(k)$ — The estimated state at time k , specified as a vector or a matrix. If specified as a matrix, then each column of the matrix represents one state vector.
- $w(k)$ — The process noise at time k .
- dt — The time step for prediction.

Example: @constacc

State transition Jacobian function — State transition Jacobian function

function handle | string

Jacobian of the state transition function, specified as a function handle or a string. If not specified, the Jacobian is numerically computed, which may increase processing time and numerical inaccuracy. If specified, the function must support one of these two syntaxes:

- If the **Enable additive process noise** parameter on the **Tracks** tab is enabled, the function must use this syntax:

$$Jx(k) = \text{statejacobianfcn}(x(k), dt)$$

where:

- $x(k)$ — The estimated state at time k , specified as an M -by-1 vector of real values.
- dt — The time step for prediction.
- $Jx(k)$ — The Jacobian of the state transition function with respect to the state, df/dx , evaluated at $x(k)$. The Jacobian is returned as an M -by- M matrix.
- If the **Enable additive process noise** parameter on the **Tracks** tab is not enabled, the function must use this syntax::

$$[Jx(k), Jw(k)] = \text{statejacobianfcn}(x(k), w(k), dt)$$

where:

- $x(k)$ — The (estimated) state at time k , specified as an M -by-1 vector of real values.
- $w(k)$ — The process noise at time k , specified as a W -by-1 vector of real values.
- dt — The time step for prediction.
- $Jx(k)$ — The Jacobian of the state transition function with respect to the state, df/dx , evaluated at $x(k)$. The Jacobian is returned as an M -by- M matrix.
- $Jw(k)$ — The Jacobian of the state transition function with respect to the process noise, df/dw , evaluated at $x(k)$ and $w(k)$. The Jacobian is returned as an M -by- W matrix.

Example: @constaccjac

Process noise matrix — Process noise matrix

eye(3) (default) | positive real scalar | positive definite matrix

Process noise covariance matrix, specified as a positive real scalar or a positive definite matrix.

- When the **Enable additive process noise** parameter on the **Tracks** tab is enabled, specify the process noise covariance as a positive real scalar or a positive definite M -by- M matrix. M is the dimension of the state vector. When specified as a scalar, the matrix is an M -by- M diagonal matrix with each diagonal element equal to the scalar.
- When the **Enable additive process noise** parameter on the **Tracks** tab is not enabled, specify the process noise covariance as a W -by- W matrix. W is the dimension of the process noise vector.

Example: [1.0 0.05; 0.05 2]

Enable additive process noise — Enable additive process noise

off (default) | on

Enable additive process noise, specified as on or off. When it is on, process noise is added to the state vector. Otherwise, noise is incorporated into the state transition function.

Fusion

State fusion function — State fusion function

Cross (default) | Intersection | Custom

State fusion function, specified as one of those options:

- **Cross** — Uses the cross-covariance fusion algorithm
- **Intersection** — Uses the covariance intersection fusion algorithm
- **Custom** — Enables you to specify a customized fusion function using the **Name of 'Custom' fusion function** parameter

Use the **State fusion parameters source** parameter to specify additional parameters used by the state fusion algorithm.

Name of 'Custom' fusion function — Name of custom assignment function

string | function handle

Name of custom assignment function, specified as a string or function handle.

The state fusion function must support one of the following syntaxes:

```
[fusedState, fusedCov] = f(trackState, trackCov)
[fusedState, fusedCov] = f(trackState, trackCov, fuseParams)
```

where:

- **trackState** is specified as an N -by- M matrix. N is the dimension of the track state, and M is the number of tracks.
- **trackCov** is specified as an N -by- N -by- M matrix. N is the dimension of the track state, and M is the number of tracks.
- **fuseParams** is the optional parameters defined in the **State fusion parameters source** parameter.

- `fusedState` is returned as an N -by-1 vector.
- `fusedCov` is returned as an N -by- N matrix.

Dependencies

To enable this property, set the **State fusion function** parameter to Custom.

State fusion parameters source — State fusion parameters source

Auto (default) | Property

State fusion parameters source, specified as one of these options:

- Auto — The block uses the default value fusion parameters for each state fusion algorithm. See **Cross covariance factor**, **Optimize covariance based on**, and **State fusion custom algorithm parameters** for more details.
- Property — Set state fusion parameters using
 - **Cross covariance factor** parameter when **State fusion function** is selected as Cross.
 - **Optimize covariance based on** parameter when **State fusion function** is selected as Intersection.
 - **State fusion custom algorithm parameters** parameter when **State fusion function** is selected as Custom.

Cross covariance factor — Cross covariance factor

0.4 (default) | scalar in range (0,1)

Cross covariance factor, specified as a scalar in the range (0,1). See `fusexcov` for more details.

Optimize covariance based on — Intersection algorithm criteria

det (default) | trace

Intersection algorithm criteria, specified as `det` or `trace`. See `fusecovint` for more details.

State fusion custom algorithm parameters — State fusion custom algorithm parameters

MATLAB variable

State fusion custom algorithm parameters, specified in any variable type, as long as it matches the setup of the optional `fuseParams` input of the custom state fusion function, specified in the **Name of 'Custom' assignment function** parameter.

Fuse only confirmed source tracks — Fuse only confirmed source tracks

on (default) | off

Fuse only confirmed source tracks, specified as `on` or `off`. Set this parameter to `off` if you want to fuse all source tracks regardless of their confirmation status.

Fuse coasted source tracks — Fuse only confirmed source tracks

off (default) | on

Fuse coasted source tracks, specified as `off` or `on`. Set this parameter to `on` if you want to fuse coasted source tracks. Set it to `off` if you want to only fuse source tracks that are not coasted.

Port Setting

Prediction time source — Source of prediction time

Auto (default) | Input port

Source for prediction time, specified as Input port or Auto. Select Input port to input an update time by using the **Prediction Time** input port. Otherwise, the simulation clock managed by Simulink determines the update time.

Enable tentative tracks output — Enable output port for tentative tracks

off (default) | on

Select this parameter to enable the output of tentative tracks through the **Tentative Tracks** output port.

Enable all tracks output — Enable output port for all tracks

off (default) | on

Select this parameter to enable the output of all the tracks through the **All Tracks** output port.

Enable information output — Enable output port for analysis information

off (default) | on

Select this parameter to enable the output port for analysis information through the **Info** output port.

Source of output bus name — Source of output track bus name

Auto (default) | Property

Source of the output track bus name, specified as:

- Auto — The block automatically creates an output track bus name.
- Property — Specify the output track bus name by using the **Specify an output bus name** parameter.

Source of output info bus name — Source of output info bus name

Auto (default) | Property

Source of the output info bus name, specified as one of these options:

- Auto — The block automatically creates an output info bus name.
- Property — Specify the output info bus name by using the **Fuser info bus name** parameter.

Algorithms

Track Structure

The fields of the track structure are:

Field	Definition
SourceIndex	Unique source index used to distinguish tracking sources in a multiple tracker environment.

Field	Definition
TrackID	Unique track identifier used to distinguish multiple tracks.
BranchID	Unique track branch identifier used to distinguish multiple track branches.
UpdateTime	Time at which the track is updated. Units are in seconds.
Age	Number of times the track survived.
State	Value of the state vector at the update time.
StateCovariance	Uncertainty covariance matrix.
TrackLogic	Confirmation and deletion logic type, returned as 'History' or 'Score'.
TrackLogicState	The current state of the track logic type. Based on the logic type <code>TrackLogic</code> , the logic state is returned as: <ul style="list-style-type: none"> 'History' — A 1-by-K logical array, where K is the number of latest track logical states recorded. In the array, 1 denotes hit and 0 denote miss. 'Score' — A 1-by-2 array of real scalars, [cs ms]. cs is the current score and ms is the maximum score.
IsConfirmed	Confirmation status. This field is <code>true</code> if the track is confirmed to be a real target.
IsCoasted	Coasting status. This field is <code>true</code> if the track is updated without a new detection.
IsSelfReported	Indicate if the track is reported by the tracker. This field is used in a track fusion environment. It is returned as <code>true</code> by default.
ObjectClassID	Integer value representing the object classification. The value 0 represents an unknown classification. Nonzero classifications apply only to confirmed tracks.
ObjectAttributes	Additional information of the track.

Extended Capabilities

C/C++ Code Generation

Generate C and C++ code using Simulink® Coder™.

See Also

Global Nearest Neighbor Multi Object Tracker | Joint Probabilistic Data Association Multi Object Tracker | Track Concatenation | Track-Oriented Multi-Hypothesis Tracker | `trackFuser`

Topics

“Create Nonvirtual Buses” (Simulink)

Introduced in R2021a

Optimal Subpattern Assignment Metric

Calculate Optimal Subpattern Assignment Metric

Library: Sensor Fusion and Tracking Toolbox / Track Metrics

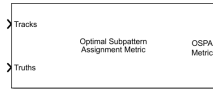

Description

The Optimal Subpattern Assignment Metric block evaluates the performance of a tracking algorithm by computing the optimal subpattern assignment (OSPA) metric between tracks and known truths. The metric is comprised of the localization error, cardinality error, and labelling error components. You can select any of the error components as a block output.

Ports

Input

Tracks — Track list

Simulink bus containing MATLAB structure

Track list, specified as a Simulink bus containing a MATLAB structure.

If you specify the **Track bus** parameter on the **Port Setting** tab to objectTrack, the structure must use this form:

Field	Description
NumTracks	Number of tracks
Tracks	Array of track structures

Each track structure must contain **TrackID** and **State** fields. Additionally, if you specify an NEES-based distance (**posnees** or **velnees**) in the **Distance type** parameter, each structure must contain a **StateCovariance** field.

Field	Definition
TrackID	Unique track identifier used to distinguish multiple tracks, specified as a nonnegative integer.
State	Value of state vector at the update time, specified as an N -element vector, where N is the dimension of the state.
StateCovariance	Uncertainty covariance matrix, specified as an N -by- N matrix, where N is the dimension of the state.

If you specify the **Track bus** parameter to **custom**, then you can use your own track bus format. In this case, you must define a track extractor function using the **Track extractor function** parameter. The function must use this syntax:

```
tracks = trackExtractorFcn(trackInputFromBus)
```

where `trackInputFromBus` is the input from the track bus and `tracks` must return as an array of structures with `TrackID` and `State` fields. If you specify an NEES-based distance (`posnees` or `velnees`) in the **Distance type** parameter, then the structure must contain a `StateCovariance` field.

Truths — Truth list

Simulink bus containing MATLAB structure

Truth list, specified as a Simulink bus containing a MATLAB structure.

If you specify the **Truth bus** parameter on the **Port Setting** tab to `Platform`, the structure must use this form:

Field	Description
<code>NumPlatforms</code>	Number of truth platforms
<code>Platforms</code>	Array of truth platform structures

Each platform structure has these fields:

Field	Definition
<code>PlatformID</code>	Unique identifier used to distinguish platforms, specified as a nonnegative integer.
<code>Position</code>	Position of the platform, specified as an M -element vector, where M is the dimension of the position state. For example, $M = 3$ for 3-D position.
<code>Velocity</code>	Velocity of the platform, specified as an M -element vector, where M is the dimension of the velocity state. For example, $M = 3$ for 3-D velocity.

If you specify the **Truth bus** parameter as `Actor`, the structure must use this form:

Field	Description
<code>NumActors</code>	Number of truth actors
<code>Actors</code>	Array of truth actor structures

Each actor structure has these fields:

Field	Definition
<code>ActorID</code>	Unique identifier used to distinguish actors, specified as a nonnegative integer.
<code>Position</code>	Position of the actor, specified as an M -element vector, where M is the dimension of the position state. For example, $M = 3$ for 3-D position.

Field	Definition
Velocity	Velocity of the actor, specified as an M -element vector, where M is the dimension of the velocity state. For example, $M = 3$ for 3-D velocity.

If you specify the **Truth bus** parameter to `custom`, then you can define your own truth bus format. In this case, you must define a truth extractor function using the **Truth extractor function** parameter. The function must use this syntax:

```
truths = truthExtractorFcn(truthInputFromBus)
```

where `truthInputFromBus` is the input from the truth bus and `truths` must return as an array of structures with `PlatformID`, `Position`, and `Velocity` fields.

Assignments — Known assignment

K-by-2 matrix of nonnegative integers

Known assignment, specified as an *K*-by-2 matrix of nonnegative integers. *K* is the number of assignment pairs. The first column elements are track IDs, and the second column elements are truth IDs. The two IDs in a row are assigned to each other. If a track or truth is not assigned, specify 0 as the other element in the row.

Assignments between tracks and truths must be unique. Redundant or false tracks should be treated as unassigned tracks by assigning them to the "0" TruthID.

Dependencies

To enable this port, on the **Port Setting** tab, select **Assignments**.

Output

OSPA Metric — OSPA metric

nonnegative real scalar

OSPA metric, returned as a nonnegative real scalar.

Example: 10.1

Localization Error — Localization error component

nonnegative real scalar

Localization error component, returned as a nonnegative real scalar.

Example: 8.5

Dependencies

To enable this port, on the **Port Setting** tab, select **Localization error**.

Cardinality Error — Cardinality error component

nonnegative real scalar

Cardinality error component, returned as a nonnegative real scalar.

Example: 6

Dependencies

To enable this port, on the **Port Setting** tab, select **Cardinality error**.

Labeling Error – Labeling error component

nonnegative real scalar

Labeling error component, returned as a nonnegative real scalar.

Example: 7.5

Dependencies

To enable this port, on the **Port Setting** tab, select **Labeling error**.

Parameters**Properties****Cutoff distance – Threshold for cutoff distance between track and truth**

30 (default) | real positive scalar

Threshold for the cutoff distance between track and truth, specified as a real positive scalar. If the computed distance between a track and the assigned truth is higher than the threshold, the actual distance incorporated in the metric is reduced to the threshold.

Example: 40

Order – Order of OSPA metric

2 (default) | positive integer

Order of the OSPA metric, specified as a positive integer.

Example: 10

Distance type – Distance type

posnees (default) | velnees | posabserr | velabserr

Distance type, specified as posnees, velnees, posabserr, or velabserr. The distance type specifies the physical quantity used for distance calculations:

- posnees - Normalized estimation error squared (NEES) of track position
- velnees - NEES error of track velocity
- posabserr - Absolute error of track position
- velabserr - Absolute error of track velocity
- custom - Custom distance error

If you select custom, you must also specify a distance function in the **Custom distance function** parameter.

Custom distance function – Custom distance function

function handle

Custom distance function, specified as a function handle. The function must support the following syntax:

```
d = myCustomFcn(Track, Truth)
```

where `Track` is a structure of track information, `Truth` is a structure of truth information, and `d` is the distance between the truth and the track. See `objectTrack` for an example on how to organize track information.

Example: `@myCustomFcn`

Dependencies

To enable this property, set the **Distance type** parameter to `custom`.

Motion model — Desired platform motion model

`constvel` (default) | `constacc` | `constturn` | `singer`

Desired platform motion model, specified as `constvel`, `constacc`, `constturn`, or `singer`. This property selects the motion model used by the **Tracks** input port.

The motion models expect the `State` field of the track structure to have a column vector containing these values:

- `constvel` — Position is in elements [1 3 5], and velocity is in elements [2 4 6].
- `constacc` — Position is in elements [1 4 7], velocity is in elements [2 5 8], and acceleration is in elements [3 6 9].
- `constturn` — Position is in elements [1 3 6], velocity is in elements [2 4 7], and yaw rate is in element 5.
- `singer` — Position is in elements [1 4 7], velocity is in elements [2 5 8], and acceleration is in elements [3 6 9].

The `StateCovariance` field of the track structure input must have position, velocity, and turn-rate covariances in the rows and columns corresponding to the position, velocity, and turn rate of the `State` field of the track structure.

Labeling error — Penalty for incorrect assignment

0 (default) | nonnegative scalar

Penalty for incorrect assignment of track to truth, specified as a nonnegative scalar. The function decides if an assignment is correct based on the provided known assignment input from the **Assignments** input port. If the assignment is not provided as an input, the last known "optimal" assignment is assumed to be correct.

Example: 5

Simulate using — Type of simulation to run

`Interpreted execution` (default) | `Code Generation`

Select a simulation type from these options:

- `Interpreted execution` — Simulate the model using the MATLAB interpreter. This option shortens startup time. In `Interpreted execution` mode, you can debug the source code of the block.
- `Code generation` — Simulate the model using generated C code. The first time you run a simulation, Simulink generates C code for the block. The C code is reused for subsequent simulations as long as the model does not change. This option requires additional startup time.

Port Setting**Assignments — Enable assignment input**

off (default) | on

Select this parameter to enable the input of known assignments through the **Assignments** input port.

Localization error — Enable localization error component output

off (default) | on

Select this parameter to enable the output of the localization error component through the **Localization Error** output port.

Cardinality error — Enable cardinality error component output

off (default) | on

Select this parameter to enable the output of the cardinality error component through the **Cardinality Error** output port.

Labeling error — Enable labeling error component output

off (default) | on

Select this parameter to enable the output of the labeling error component through the **Labeling Error** output port.

Track bus — Track bus selection

objectTrack (default) | custom

Track bus selection, specified as `objectTrack` or `custom`. See the description of the **Tracks** input port for more details about each selection.

Truth bus — Truth bus selection

Platform (default) | Actor | custom

Truth bus selection, specified as `Platform`, `Actor`, or `custom`. See the description of the **Truths** input port for more details about each selection.

Track extractor function — Track extractor function

function handle

Track extractor function, specified as a function handle. The function must support this syntax:

```
tracks = trackExtractorFcn(trackInputFromBus)
```

where `trackInputFromBus` is the input from the track bus and `tracks` must return as an array of structures with `TrackID` and `State` fields. If you specify an NEES-based distance (`posnees` or `velnees`) in the **Distance type** parameter, then the structure must contain a `StateCovariance` field.

Example: `@myCustomFcn`

Dependencies

To enable this property, set the **Track bus** parameter to `custom`.

Truth extractor function – Truth extractor function

function handle

Truth extractor function, specified as a function handle. The function must support this syntax:

```
truths = truthExtractorFcn(truthInputFromBus)
```

where `truthInputFromBus` is the input from the track bus and `truths` must return as an array of structures with `PlatformID`, `Position`, and `Velocity` as field names.

Example: `@myCustomFcn`

Dependencies

To enable this property, set the **Truth bus** parameter to `custom`.

Algorithms**OSPA Metric**

At time t_k , a list of truths is:

$$X = [x_1, x_2, \dots, x_m]$$

At the same time, a tracker obtains a list of tracks:

$$Y = [y_1, y_2, \dots, y_n]$$

The OSPA metric (used to evaluate the tracking performance based on the truth) is:

$$OSPA = (d_{loc}^p + d_{card}^p + d_{lab}^p)^{1/p}$$

Assuming $m \leq n$, the three components (d_{loc} , d_{card} , and d_{lab}) are calculated as follows. The localization error component d_{loc} is computed as:

$$d_{loc} = \left\{ \frac{1}{n} \sum_{i=1}^m d_c^p(x_i, y_{\Pi(i)}) \right\}^{1/p}$$

where p is the order of the OSPA metric, d_c is the cutoff-based distance, and $y_{\Pi(i)}$ represents the track assigned to truth x_i . The cutoff-based distance d_c is defined as:

$$d_c(x, y) = \min\{d_b(x, y), c\}$$

where c is the cutoff distance threshold, and $d_b(x, y)$ is the base distance between track x and truth y calculated by the distance function. The cutoff based distance d_c takes the smaller value of d_b and c .

The cardinality error component d_{card} is:

$$d_{card} = \left\{ \frac{n - m}{n} c^p \right\}^{1/p}$$

The labeling error component d_{lab} is:

$$d_{lab} = \left\{ \frac{1}{n} \sum_{i=1}^m \alpha^p \gamma(L(x_i), L(y_{\Pi(i)})) \right\}^{1/p}$$

where α is the penalty for incorrect assignment, $L(x_i)$ represents the truth ID of x_i , and $L(y_{\Pi(i)})$ represents the track ID of $y_{\Pi(i)}$. The function $\gamma = 1$ if the IDs of the truth and track pair ($L(x_i)$ and $L(y_{\Pi(i)})$) agree with the known assignment given by the assignment input, or agree with the assignment in the last update if the known assignment is not given. Otherwise, $\gamma = 0$.

If $m > n$, simply exchange m and n in the formulation to obtain the OSPA metric.

References

- [1] Schuhmacher, B., B. -T. Vo, and B. -N. Vo. "A Consistent Metric for Performance Evaluation of Multi-Object Filters." *IEEE Transactions on Signal Processing*, Vol, 56, No, 8, pp. 3447-3457, 2008.
- [2] Ristic, B., B. -N. Vo, D. Clark, and B. -T. Vo. "A Metric for Performance Evaluation of Multi-Target Tracking Algorithms." *IEEE Transactions on Signal Processing*, Vol, 59, No, 7, pp. 3452-3457, 2011.

Extended Capabilities

C/C++ Code Generation

Generate C and C++ code using Simulink® Coder™.

See Also

Generalized Optimal Subpattern Assignment Metric | `trackAssignmentMetrics` | `trackErrorMetrics` | `trackGOSPAMetric` | `trackOSPAMetric`

Introduced in R2021a

Apps

Tracking Scenario Designer

Design tracking scenarios, configure platforms and sensors, and generate synthetic object detections

Description

The **Tracking Scenario Designer** app enables you to design and visualize synthetic tracking scenarios for testing your estimation and tracking systems.

Using the app, you can:

- Create platforms (including planes, cars, towers, and boats) using an interactive interface and configure platform properties in the tracking scenario.
- Configure 2D or 3D trajectories (including position, orientation, and velocities) of platforms using waypoint trajectories in the tracking scenario.
- Create radar sensors mounted on the platform and configure sensor properties.
- Simulate the tracking scenario and dynamically visualize the platform trajectories, sensor coverages, and object detections.
- Generate MATLAB code of the scenario and sensors, and then programmatically modify the scenario for application purposes. You can also import the previously saved scenario back into the app for further simulation.
- Import a `trackingScenario` object in the app for visualization and further design of the tracking scenario. See “Programmatic Use” on page 5-25 for the limitations of importing a `trackingScenario` object.

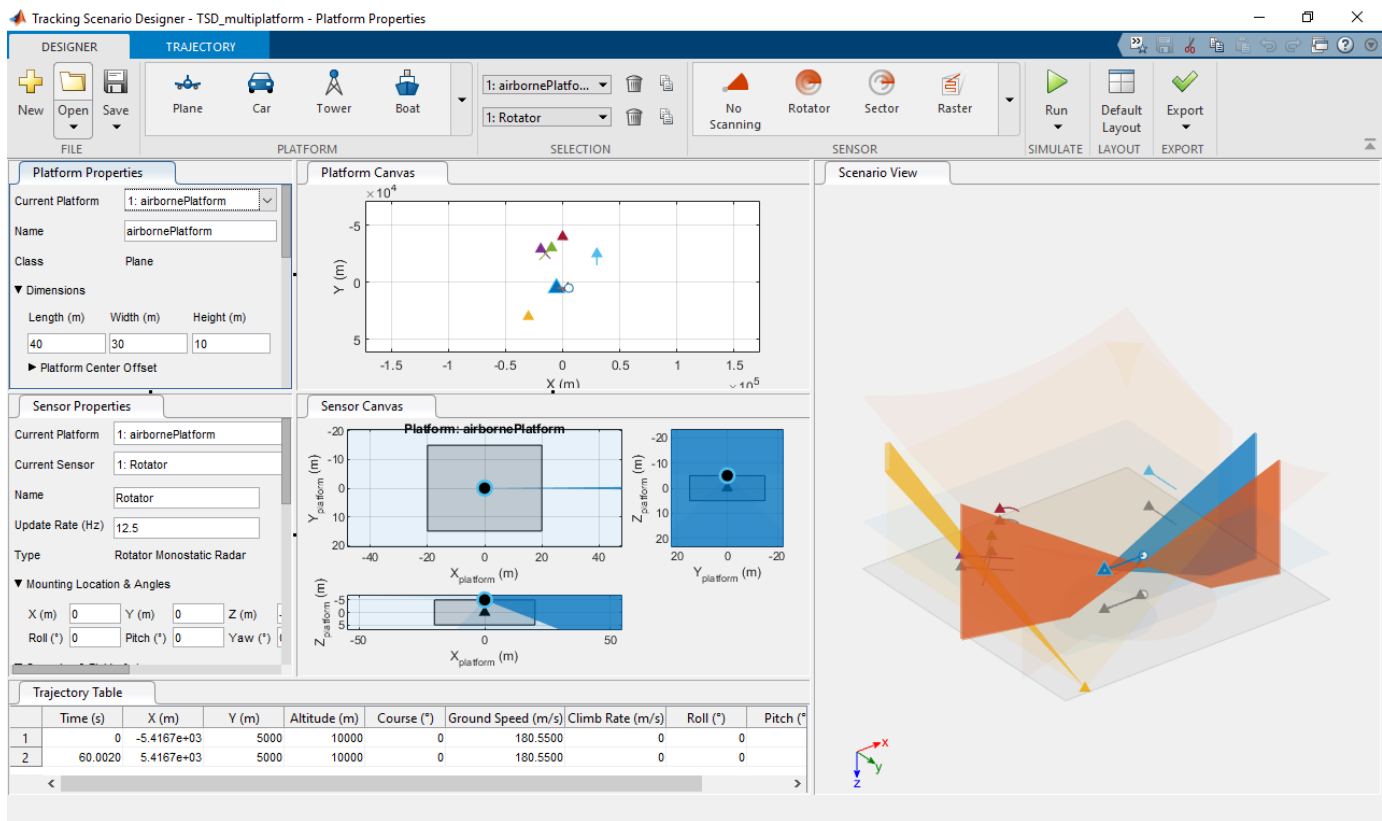

Open the Tracking Scenario Designer App

- MATLAB Toolstrip: On the **Apps** tab, under **Signal processing and communications**, click the app icon .
- MATLAB command prompt: Enter `trackingScenarioDesigner`.

Examples

Set Up Platforms in Tracking Scenario Designer

To launch the Tracking Scenario Designer, use the command:

```
trackingScenarioDesigner
```

To add a platform in the app, select one platform (tower, for example) from the **PLATFORM** tab and click the **Platform Canvas** to place the platform.

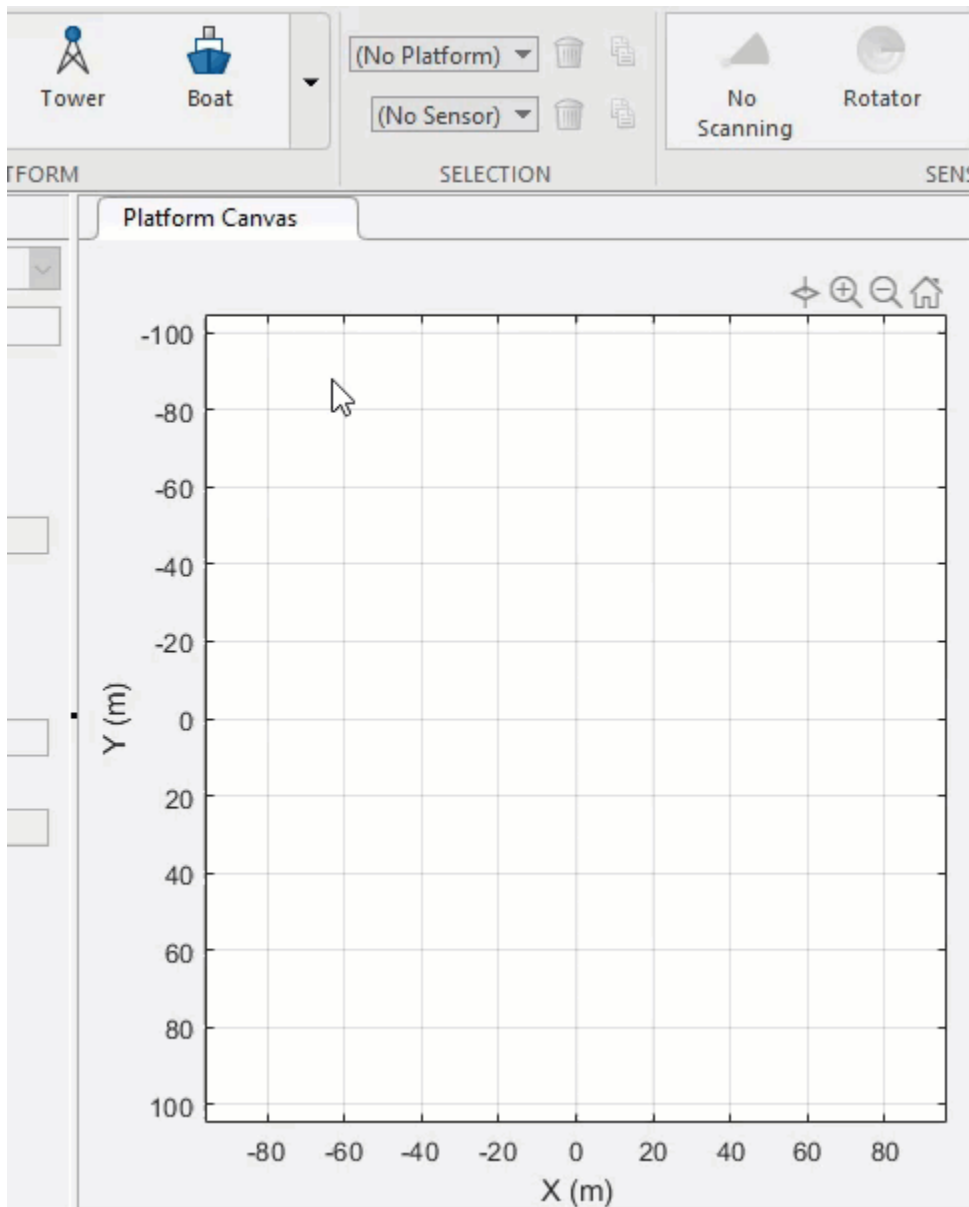

You can change the platform properties through the **Platform Properties** tab. For example, to set the platform center to the origin, set all initial position coordinates to zero in **Initial Pose**.

▼ Initial Pose

X (m)	Y (m)	Altitude (m)
0	0	0

You can also change the **Length**, **Width**, and **Height** of the platform. By default, the Tower platform's offset in the z direction is half of the platform height, which places the tower center at its bottom. If the offset is zero, then the platform center collocates with the tower's geometric center.

▼ Dimensions		
Length (m)	Width (m)	Height (m)
10	10	60
▼ Platform Center Offset		
X (m)	Y (m)	Z (m)
0	0	30

The center offset is defined as the position vector from the geometric center of a platform to the specified center of the platform.

In the app, you can also specify the uncertainty of the estimated platform pose through the **Pose Estimation** tab. The value of each parameter in the tab represents the standard deviation of the corresponding quantity. The standard deviation setup is useful for some practical tracking considerations. For example, the accuracy of a sensor mounted on a tower is impacted if the pose of the tower includes errors. In the app, if you set the standard deviations to be nonzero values for a platform with a mounting sensor, you can observe the inaccuracy of the sensor detections introduced by these standard deviations.

▼ Pose Estimation		
Roll (°)	Pitch (°)	Yaw (°)
2	3	1
Position (m)	Velocity (m/s)	
1	0.1	

You can also add other platforms in the app. Add a **Plane** platform on the canvas and set its initial position as [50, -50, 100]. You can see the center of the plane (red) is at its geometric center by default.

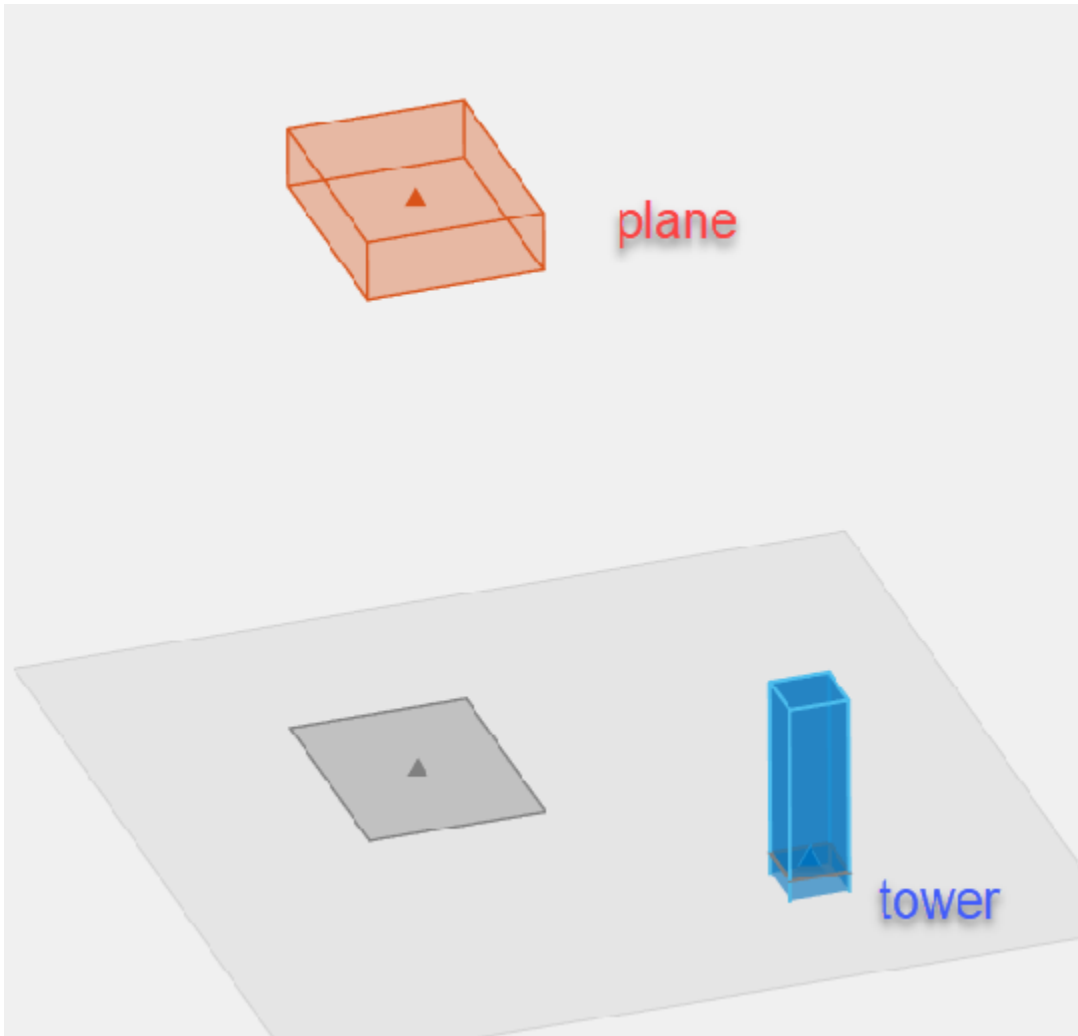

You can change the default setting of any class (and define new classes) using the **Platform Gallery Editor**, which you can open by clicking the drop-down arrow on the **PLATFORM** tab.

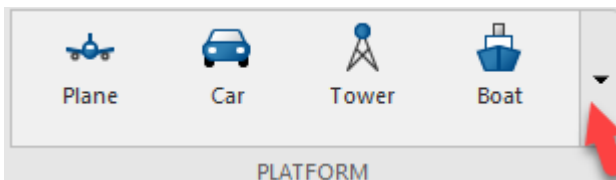

You cannot edit the class of a currently used platform. To delete a platform, select the platform from the drop-down list and click the delete (trash can) icon.

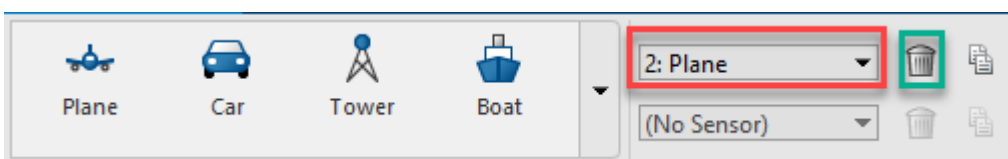

Set Up Trajectories of Platforms in Tracking Scenario Designer

To launch the Tracking Scenario Designer, use the command:

```
trackingScenarioDesigner
```

Add a Plane platform on the platform canvas and place the plane at [0, 0, 1000] by specifying its initial position through the **Initial Pose** tab as:

▼ Initial Pose		
X (m)	Y (m)	Altitude (m)
0	0	1000
Roll (°)	Pitch (°)	Yaw (°)
0	0	0

Next, add a few waypoints to the platform. Right-click the platform and select **Add Waypoints**, or select the platform and click **Waypoints** on the **TRAJECTORY** toolstrip. Then consecutively click the canvas to add waypoints. To end the action, on the keyboard, click **Enter**. You can drag the waypoints to change the trajectory. The specified trajectory represents the trajectory of the platform center defined in the **Platform Center Offset** tab.

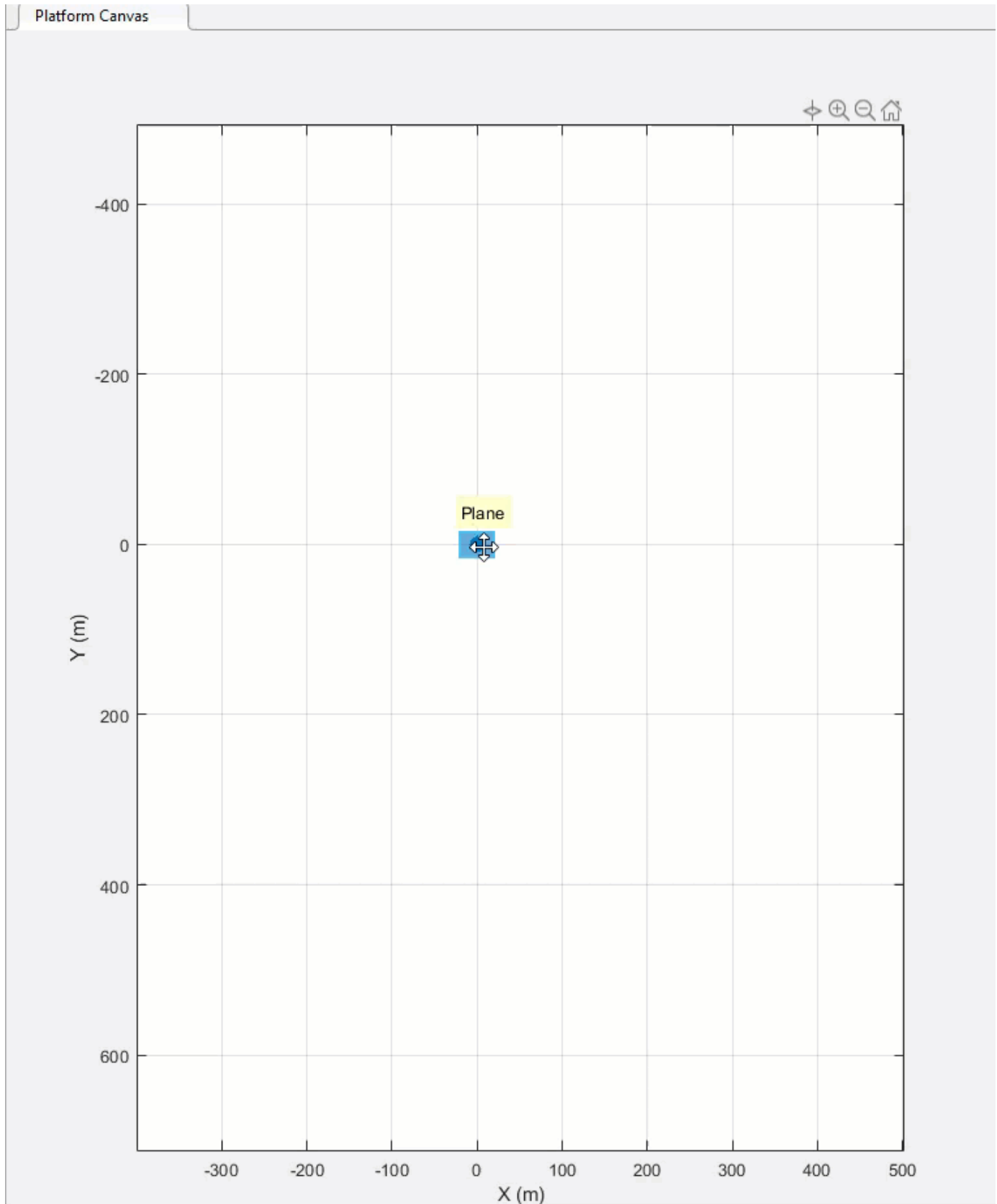

On the **TRAJECTORY** tab, if the **Trajectory Course** and the **Platform Orientation** parameters are set to **auto**, the app calculates the trajectory by fitting a smooth curve including all the waypoints and aligning the platform orientation with the trajectory. With **Time** set to **Auto**, the app calculates the trajectory duration (**Time**) based on the default platform speed, which can be specified through the **PLATFORM Gallery Editor**.

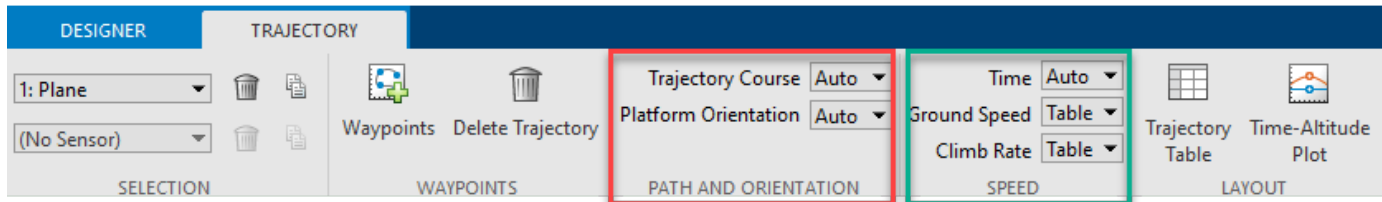

To display the trajectory table below, click **Trajectory Table**. To display the Time-Altitude plot, click **Time-Altitude Plot**.

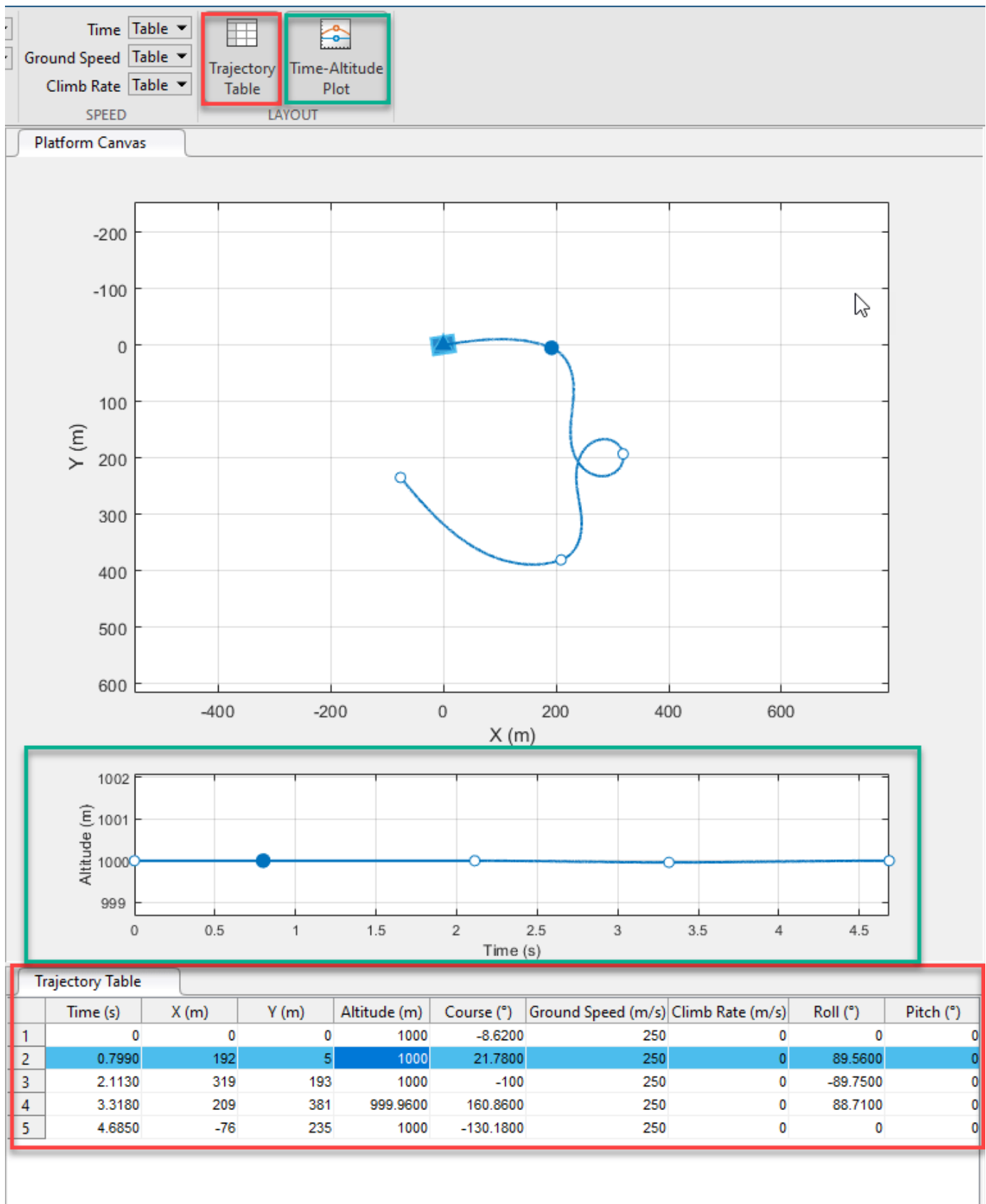

After changing a trajectory parameter selection from **Auto** to **Table**, you can edit the corresponding quantity in the **Trajectory Table**. After you edit the table, observe the change of the trajectory .

You can drag points up and down in altitude in the Time-Altitude plot. After setting **Time** to **Table**, you can drag points forward and backward in time.

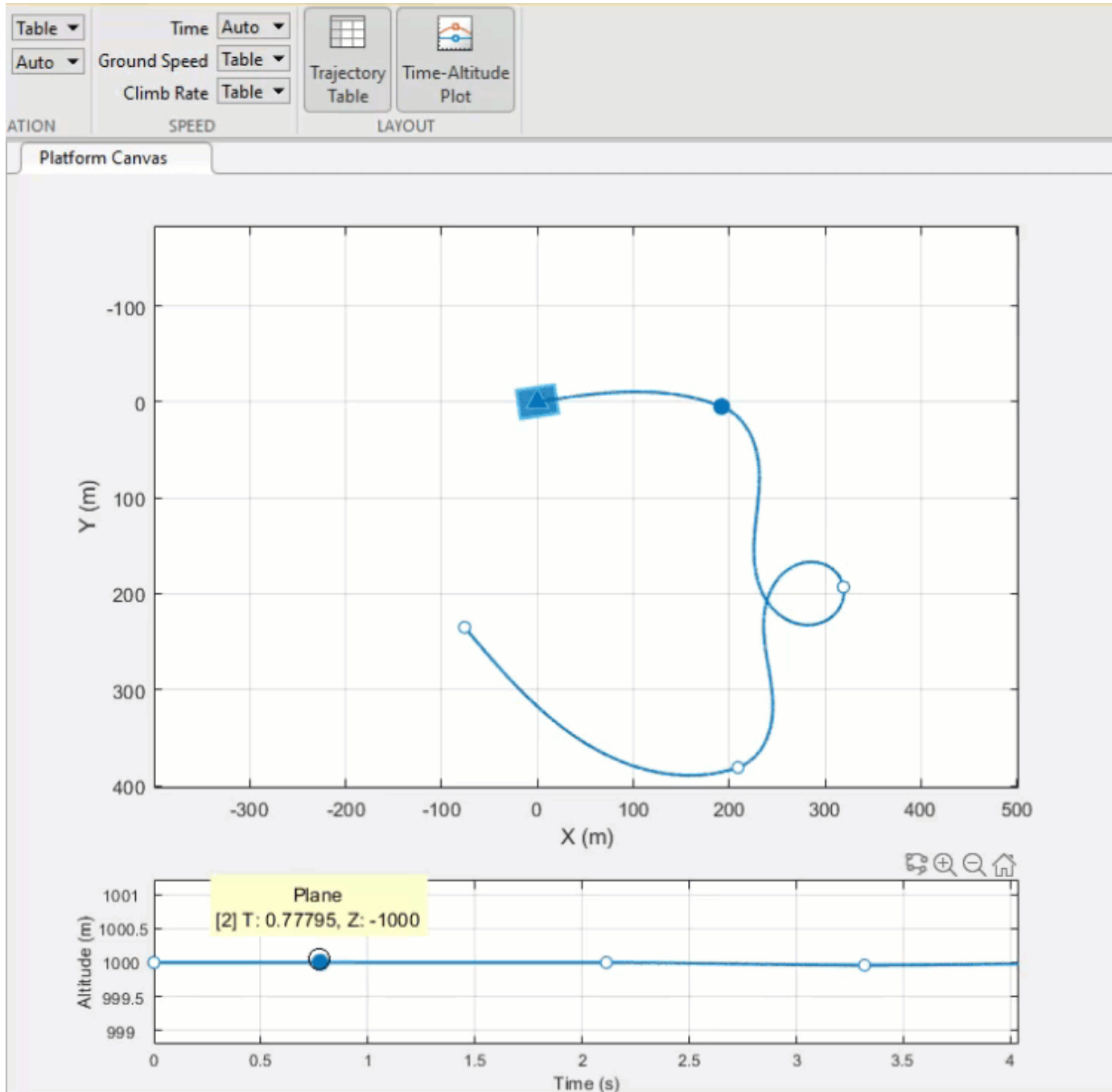

To delete a trajectory, select the trajectory and click **Delete Trajectory**.

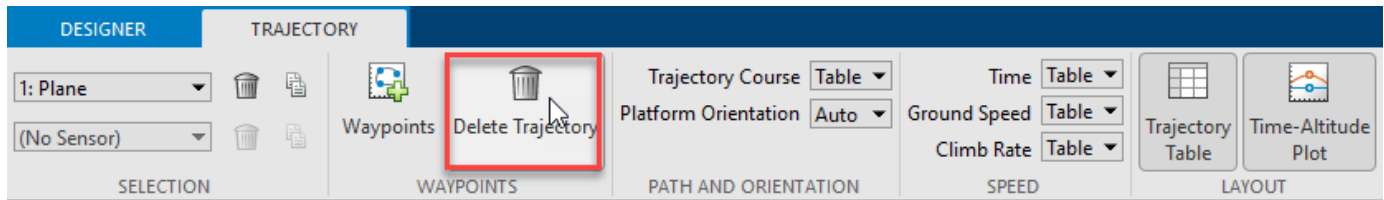

Set Up Sensors In Tracking Scenario Designer

The MAT-file TSD_Platforms was previously saved with a tracking scenario session. To launch the application and load the session file, use the command:

```
trackingScenarioDesigner('TSD_Platforms.mat')
```

The application opens and loads the scenario. The scenario contains two platforms:

- A 60-meter high tower located at the origin of the local NED frame.
- A target traveling at a course speed of 750 m/s around the tower.

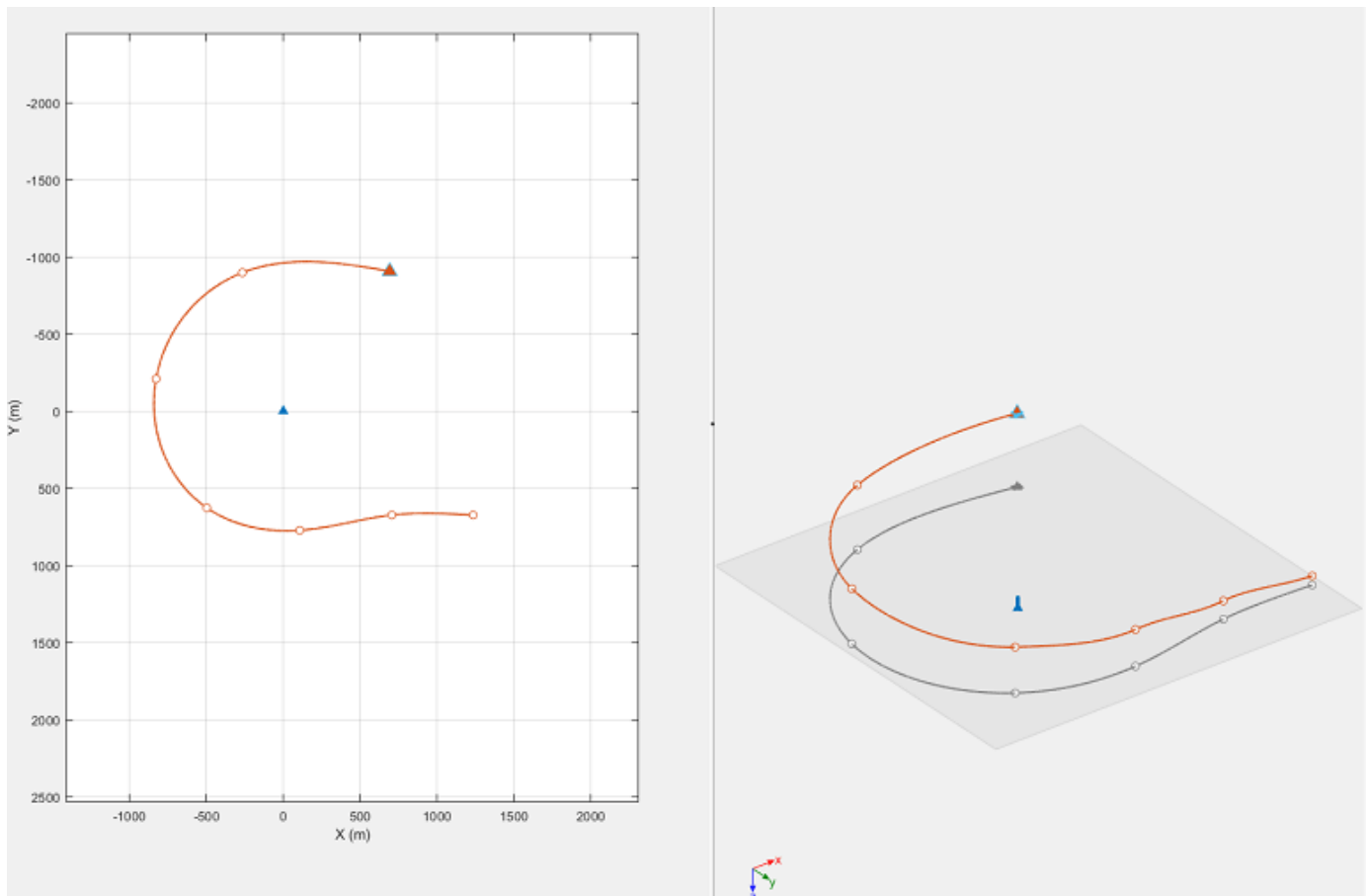

Next, mount a sensor on the top of the tower to monitor its surroundings. There are four predefined classes of sensors available in the app.

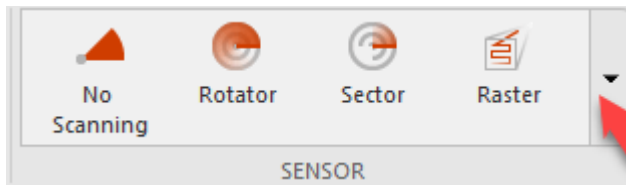

You can also click the drop-down arrow to edit the existing classes or add new classes of sensors.

In the app, you select the tower platform, choose a rotator sensor, and place it on the top of the tower. Click the projection button to enable a y-z projection view.

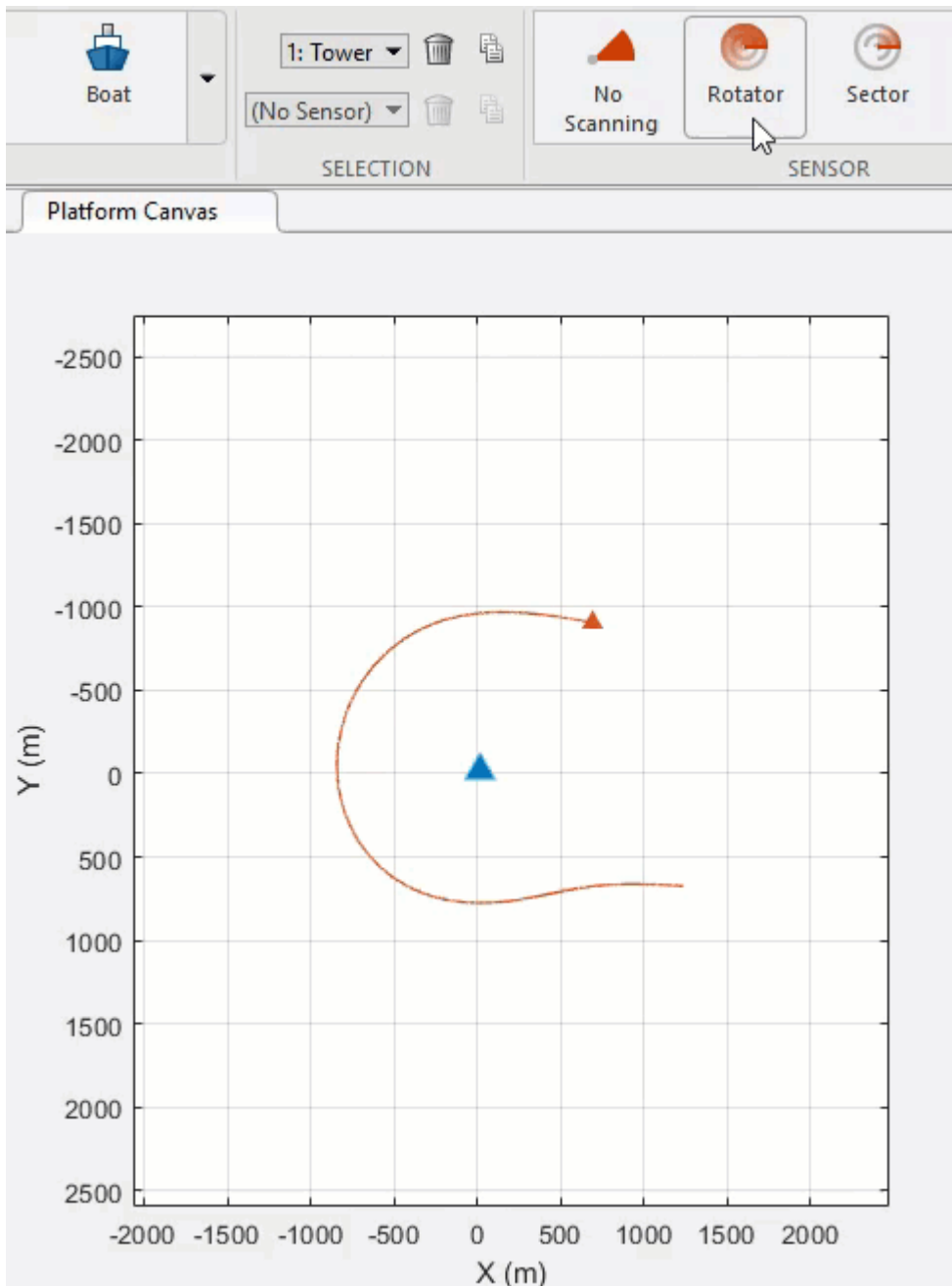

The sensor is positioned at the bottom of the tower by default. To move the sensor to the top of the tower, change its **Mounting Location & Angles**.

▼ Mounting Location & Angles

X (m)	<input type="text" value="0"/>	Y (m)	<input type="text" value="0"/>	Z (m)	<input type="text" value="-60"/>
Roll (°)	<input type="text" value="0"/>	Pitch (°)	<input type="text" value="0"/>	Yaw (°)	<input type="text" value="0"/>

Enable detection in the elevation by selecting **Report Elevation**. Set the sensor's **Field of View** for **Elevation** to 15 deg to allow a wide coverage region in elevation. Set the **Mechanical scan limits** for **Elevation** to [-15, -5] deg to let the sensor "stare up".

▼ Scanning & Field of view

Report Elevation

Scan Mode: Mechanical

	Azimuth		Elevation	
Field of View (°)	1		15	
Mechanical scan limits (°)	0	360	-15	-5
Max scan rate (°/s)	75		75	

To simulate the tracking scenario and observe the detection of the target generated by the sensor, Click **Run**. (You can also choose **Run Without Detections**.)

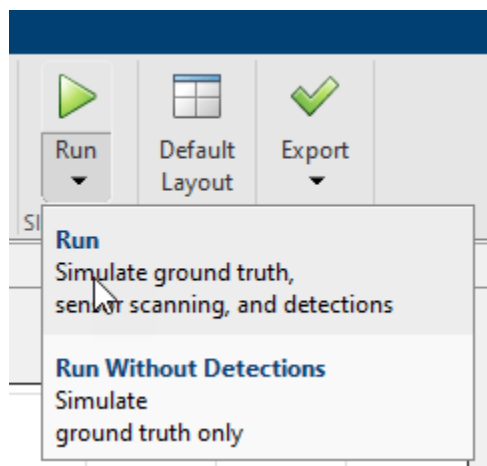

You find that the sensor generates only one detection. You can let the sensor scan faster and generate more detections by adjusting its scan rate using two parameters:

- Update Rate — Determines the number of field of view slices the sensor steps through per second.
- Field of View — Determines the width of each sensor field of view slice or beam.

In the app, increase the **Update Rate** of the sensor to 200 Hz. With the azimuthal field of view set as 1 deg, the resulting scan rate in the azimuth is 200 deg/s, which is above the default **Max scan rate** (75 deg/s). Increase **Max scan rate** to 300 deg/s to allow a high scan rate.

Click **Run** to simulate the scenario again. The sensor now generates multiple sets of detections.

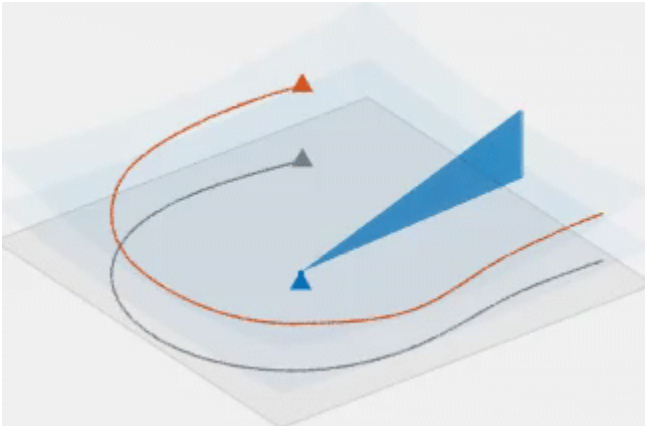

You can also export the script of the scenario by clicking **Export**. Using the exported script, you can modify the scenario programatically and use the generated scenario to test various tracking algorithms. See “Design and Simulate Tracking Scenario with Tracking Scenario Designer” example for more details on how to modify the generated scenario.

- “Design and Simulate Tracking Scenario with Tracking Scenario Designer”

Parameters

Platform Properties – Platform properties including dimensions, pose, and RCS tab

To enable the **Platform Properties** parameters, add at least one platform to the scenario. Then, select a platform from either the **Platform Canvas** or the **Platform Properties** parameter. The parameter values in the **Platform Properties** tab are based on the platform that you select.

Parameter	Description
Current Platform	Currently selected platform, specified as a list of platforms in the scenario.
Name	Name of platform, specified as a string.
Class	Platform class, specified as Plane, Tower, Car, or Boat.

You can change the default settings (such as **Speed**) of the four platform classes and add new platform classes using the **Platform Gallery Editor**. You can open the editor by clicking the drop-down arrow on the **PLATFORM** tab and selecting **Add/Edit Platform Gallery**.

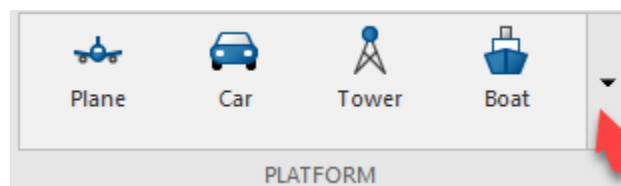

Dimensions – Platform dimensions tab

Platform dimensions, specified as **Length**, **Width**, and **Height** in meters.

Parameter	Description
Length (m)	Length of platform, specified as a nonnegative scalar in meters.
Width (m)	Width of platform, specified as a nonnegative scalar in meters.
Height (m)	Height of platform, specified as a nonnegative scalar in meters.

You can also specify the **Platform Center Offset** using the **X**, **Y**, and **Z** offsets. The offset is measured from the geometric center of the platform to the specified center.

Parameter	Description
X (m)	Offset in the x-direction, specified as a scalar in meters.
Y (m)	Offset in the y-direction, specified as a scalar in meters.
Z (m)	Offset in the z-direction, specified as a scalar in meters.

Initial Pose – Initial position and orientation of platform

tab

Initial position and orientation of platform, specified by three position coordinates **X**, **Y**, and **Altitude** in meters and three rotational angles **Roll**, **Pitch**, and **Yaw** in degrees.

Parameter	Description
X (m)	Initial x coordinate of the platform center in the scenario frame, specified as a scalar in meters.
Y (m)	Initial y coordinate of the platform center in the scenario frame, specified as a scalar in meters.
Altitude (m)	Initial altitude of the platform center in the scenario frame, specified as a scalar in meters.
Roll (°)	Orientation angle of the platform about the x-axis of the scenario frame, specified as a scalar in degrees.
Pitch (°)	Orientation angle of the platform about the y-axis of the scenario frame, specified as a scalar in degrees.
Yaw (°)	Orientation angle of the platform about the z-axis of the scenario frame, specified as a scalar in degrees.

Pose Estimation – Accuracy of platform pose estimation

tab

Accuracy of the platform pose estimation, specified as standard deviations for three rotational angles : **Roll**, **Pitch**, and **Yaw**, and two translational motion quantities : **Position** and **Velocity**.

When the standard deviation value of any motion quantity is specified as nonzero, the platform pose contains errors corresponding to that motion quantity.

Parameter	Description
Roll (°)	Standard deviation of the roll angle of the platform, specified as a scalar in degrees.
Pitch (°)	Standard deviation of the pitch angle of the platform, specified as a scalar in degrees.
Yaw (°)	Standard deviation of the yaw angle of the platform, specified as a scalar in degrees.
Position (m)	Standard deviation of position coordinates of the platform, specified as a scalar in degrees.
Velocity (m)	Standard deviation of velocity coordinates of the platform, specified as a scalar in degrees.

Radar Cross Section — Radar cross section information

tab

Radar cross section information, including RCS pattern information and RCS Viewer specifications. You can specify a constant RCS pattern as a scalar in dBsm, or you can import RCS information through the **Import Signature** window after selecting the **Import RCS** tab.

Parameter	Description
Constant RCS Pattern	RCS pattern, specified as a positive constant in dBsm.
Import RCS	Import RCS pattern through an Import Signature window.

You can also specify the **RCS Viewer** by changing the **Elevation Cut** in degrees and the **Frequency Cut** in Hz.

Parameter	Description
Elevation Cut	Elevation cut of RCS viewer, specified as a scalar in degrees.
Frequency Cut	Frequency cut of RCS viewer, specified as a scalar in Hz.

Sensor Properties — Sensor properties including sensor mounting, scanning settings, and detection settings

tab

To enable the **Sensor Properties** parameters, add at least one sensor to the platform. Then, select a sensor from either the **Sensor Canvas** or the **Sensor Properties** tab. The parameter values in the **Sensor Properties** tab are based on the platform and sensor that you select.

Parameter	Description
Current Platform	Current platform on which the sensor is mounted, specified as a list of platforms in the scenario.

Parameter	Description
Current Sensor	Currently selected sensor, specified as a list of sensors in the scenario.
Name	Name of sensor, specified as a string.
Update Rate	Sensor update rate, specified as a positive scalar in Hz.
Type	Sensor type, specified as: <ul style="list-style-type: none"> • Sector Monostatic Radar • No Scanning Monostatic Radar • Rotator Monostatic Radar • Raster Monostatic Radar

Mounting Location & Angles – Sensor mounting location and angles

tab

Sensor mounting location and angles on the platform, specified by three position coordinates **X**, **Y**, and **Z** in meters and three rotational angles **Roll**, **Pitch**, and **Yaw** in degrees.

Parameter	Description
X (m)	x coordinate of the sensor on the platform frame, specified as a scalar in meters.
Y (m)	y coordinate of the sensor on the platform frame, specified as a scalar in meters.
Z (m)	z coordinate of the sensor on the platform frame, specified as a scalar in meters.
Roll (°)	Orientation angle of the sensor about the x-axis of the platform frame, specified as a scalar in degrees.
Pitch (°)	Orientation angle of the sensor about the y-axis of the platform frame, specified as a scalar in degrees.
Yaw (°)	Orientation angle of the sensor about the z-axis of the platform frame, specified as a scalar in degrees.

Scanning & Field of view – Scanning and field of view of sensor

tab

Parameter	Description
Report Elevation	Enable sensor reporting elevation information, specified as on or off.
Scan Mode	Mode of sensor scanning, selected as Mechanical, Electric, or Mechanical and Electric.

Parameter	Description
Field of View (°)	Field of view of the sensor, specified as two nonnegative scalars representing Azimuth and Elevation in degrees.
Mechanical scan limits (°)	Upper and lower limits of mechanical scan, specified as two scalars for Azimuth in degrees. If Report Elevation is enabled, you can specify the scan limits for Elevation in degrees. To enable this parameter, set the Scan Mode to Mechanical or Mechanical and electric .
Electronic scan limits (°)	Upper and lower limits of electronic scan, specified as two scalars for Azimuth in degrees. If Report Elevation is enabled, you can specify the scan limits for Elevation in degrees . To enable this parameter, set the Scan Mode to Electric or Mechanical and electric .
Max scan rate (°/s)	Maximum scan rate, specified as a scalar for Azimuth in degrees per second. If Report Elevation is enabled, you can specify the maximum scan rate for Elevation in degrees per second. If the specified scan rate (Update Rate * Field of View) is larger than the Max scan rate , the sensor scan rate is truncated at the Max scan rate . To enable this parameter, set the Scan Mode to Mechanical or Mechanical and electric .

Detections Settings – Detections Settings

tab

Detection settings of the sensor, specified by using detections probability, false alarm rate, reference range, and reference RCS.

Parameter	Description
Detection Probability	Probability of sensor successfully detecting a target, specified as a scalar in [0,1]. This quantity defines the probability of detecting a target with a radar cross-section larger than the Reference RCS and within the Reference Range of the sensor.
False Alarm Rate	Probability of sensor making a false detection in each sensor resolution cell, specified as a scalar in [1e-7,1e-3].

Parameter	Description
Reference Range (m)	Reference range for the given Detection Probability and the given Reference RCS , specified as a positive scalar in meters.
Reference RCS (dBsm)	Reference radar cross-section (RCS) for the given Detection Probability and the given Reference Range , specified as a scalar in dBsm.

Advanced Settings – Advanced settings

tab

Advanced settings of the sensor are listed in this table.

Parameter	Description
Max Number of Detections	Maximum number of detections reported by the sensor, specified as a positive integer.
Report False Alarm	Enable the sensor to model and report false alarms, specified as <code>on</code> or <code>off</code> . When specified as <code>off</code> , the sensor does not generate any false detection.
Report Range Rate	Enable the radar to measure and report target range rates, specified as <code>on</code> or <code>off</code> .
Model Target Occlusion	Enable occlusion of objects from extended objects, specified as <code>on</code> or <code>off</code> . Turn off this option to disable occlusion of extended objects.
Model Range Ambiguity	Enable range ambiguities, specified as <code>on</code> or <code>off</code> . When specified as <code>off</code> , the sensor cannot resolve range ambiguities and target ranges beyond the Max Unambiguous Range are wrapped into the interval $[0, \text{MaxUnambiguousRange}]$. When false, targets are reported at their unambiguous range.
Model Range Rate Ambiguity	Enable range-rate ambiguities, specified as <code>on</code> or <code>off</code> . Turn on this option to enable range-rate ambiguities by the sensor. When true, the sensor does not resolve range rate ambiguities and target range rates beyond the Max Unambiguous Radial Speed are wrapped into the interval $[-\text{MaxUnambiguousRadialSpeed}, \text{MaxUnambiguousRadialSpeed}]$. When false, targets are reported at their unambiguous range rate. To enable this parameter, set Report Range Rate to <code>on</code> .

Parameter	Description
Max Unambiguous Range (m)	Maximum unambiguous range, specified as a positive scalar. Maximum unambiguous range defines the maximum range for which the radar can unambiguously resolve the range of a target.
Max Unambiguous Radial Speed (m/s)	Maximum unambiguous radial speed, specified as a positive scalar. Radial speed is the magnitude of the target range rate. Maximum unambiguous radial speed defines the radial speed for which the radar can unambiguously resolve the range rate of a target. To enable this parameter, set Report Range Rate to on.

Accuracy & Noise – Accuracy and noise settings

tab

The accuracy and noise setting of the sensor are listed in this table.

Parameter	Description
Azimuth (°)	Azimuth resolution and bias, specified as two nonnegative scalars: <ul style="list-style-type: none"> • Azimuth resolution defines the minimum separation in azimuth angle at which the radar can distinguish two targets. • Azimuth bias is expressed as a fraction of the azimuth resolution. This value sets a lower bound on the azimuthal accuracy of the sensor.
Elevation (°)	Elevation resolution and bias, specified as two nonnegative scalars: <ul style="list-style-type: none"> • Elevation resolution defines the minimum separation in elevation angle at which the radar can distinguish two targets. • Elevation bias is expressed as a fraction of the azimuth resolution. This value sets a lower bound on the elevation accuracy of the sensor. <p>To enable this parameter, turn on Report Elevation.</p>

Parameter	Description
Range (m)	Range resolution and bias, specified as two nonnegative scalars: <ul style="list-style-type: none"> Range resolution defines the minimum separation in range at which the radar can distinguish between two targets. Range bias is expressed as a fraction of the range resolution. This value sets a lower bound on the range accuracy of the radar.
Range Rate (m/s)	Range rate resolution and bias, specified as two nonnegative scalars: <ul style="list-style-type: none"> Range rate resolution defines the minimum separation in range rate at which the radar can distinguish between two targets. Range rate bias is expressed as a fraction of the range rate resolution. This value sets a lower bound on the range rate accuracy of the radar.
Add noise to measurements	Add measurement noise in the detections, specified as on or off.

TRAJECTORY — Trajectory settings

tab on toolstrip

To edit the trajectory and control the trajectory generation, use the trajectory settings.

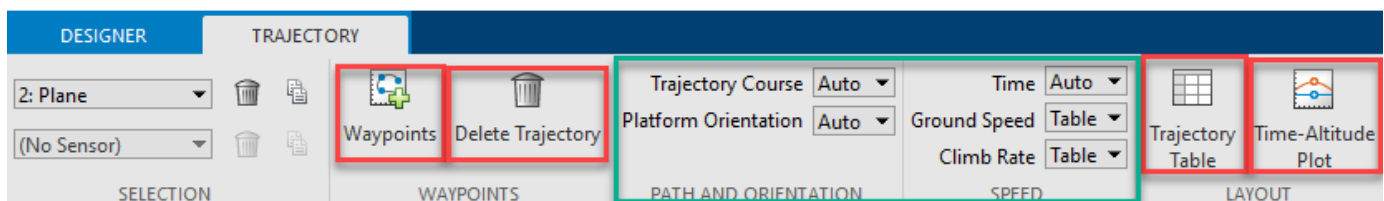

- Click **Waypoints** to add waypoints to a selected platform.
- Click **Delete Trajectory** to delete an existing trajectory.
- Click **Trajectory Table** to display the trajectory table.
- Click **Time-Altitude plot** to display the time vs altitude plot.

You can also choose to automatically generate the waypoint trajectory or manually input waypoints by changing the selections of the **PATH AND ORIENTATION** and the **SPEED** parameters.

Parameter	Selection
Trajectory Course	<ul style="list-style-type: none"> Auto: When selected, the app generates the course by fitting all the waypoints with a smooth curve. Table: When selected, you can manually edit the trajectory course at each waypoint using the Trajectory Table.

Parameter	Selection
Platform Orientation	<ul style="list-style-type: none"> Auto: When selected, the app calculates the yaw and pitch angles of the platform to align the platform with the trajectory and calculates the roll angle to cancel the centripetal acceleration. Table: When selected, you can manually edit the yaw, pitch, and roll angles at each waypoint using the Trajectory Table.
Time	<ul style="list-style-type: none"> Auto: When selected, the app calculates the visiting time at all the waypoints. Table: When selected, you can manually edit the visiting time at each waypoint using the Trajectory Table.
Ground speed	<ul style="list-style-type: none"> Auto: When selected, the app uses the default ground speed for each platform class at each waypoint. Table: When selected, you can manually edit the ground speed at each waypoint using the Trajectory Table.
Climb Rate	<ul style="list-style-type: none"> Auto: When selected, the app calculates the climb rate at each waypoint to smoothly fit all the waypoints. Table: When selected, you can manually edit the climb rate at each waypoint using the Trajectory Table.

Trajectory Table – Trajectory information

table

Trajectory information for each waypoint, specified as a table of scalars. When you insert waypoints on the platform canvas, the table is automatically generated. Click **Trajectory Table** under the **Trajectory** tab to display the table.

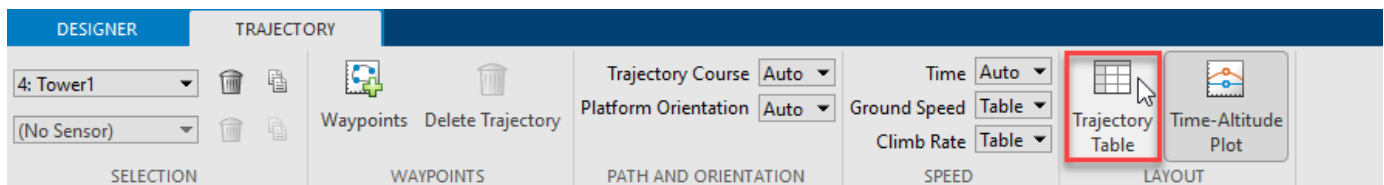

After you change the parameter values in the table, the platform trajectory changes accordingly on the canvas. The table includes these trajectory parameters.

Parameter	Description
Times (s)	Time at which the platform visits the waypoint, specified as a scalar in seconds.
X (m)	x coordinate of the waypoint in the scenario navigation frame.
Y (m)	y coordinate of the waypoint in the scenario navigation frame.
Altitude (m)	Altitude of the platform waypoint in the scenario navigation frame.

Parameter	Description
Course (°)	The direction of motion on the x-y plane, specified as an angle measurement from the x direction.
Ground speed (m/s)	Magnitude of the projected velocity on the x-y plane, specified as a scalar in meters.
Climb Rate (m/s)	Climb rate of the waypoint, which is the projection of the platform velocity in the z direction.
Roll (°)	Orientation angle of the platform about the x-axis of the scenario frame, in degrees, specified as a scalar.
Pitch (°)	Orientation angle of the platform about the y-axis of the scenario frame, in degrees, specified as a scalar.
Yaw (°)	Orientation angle of the platform about the z-axis of the scenario frame, in degrees, specified as a scalar.

Programmatic Use

The `trackingScenarioDesigner` command opens the **Tracking Scenario Designer** app.

The `trackingScenarioDesigner(scenarioFileName)` command opens the app and loads the specified scenario MAT-file into the app. This file must be a tracking scenario file saved from the app.

If the scenario file is not in the current folder or not in a folder on the MATLAB path, specify the full path name. For example:

```
drivingScenarioDesigner('C:\Desktop\myTrackingScenario.mat');
```

You can also load prebuilt scenario files. Before loading a prebuilt scenario, add the folder containing the scenario to the MATLAB path.

The `trackingScenarioDesigner(scenario)` command opens the app and loads the specified `trackingScenario` object, `scenario`, into the app with the following limitations:

- The `IsEarthCentered` property of the scenario must set to `false`.
- The app ignores the `StopTime` and `UpdateRate` properties of the scenario.
- The `ClassID` property value of any platform in the scenario must be equal to one of the default Class ID values in the app.
- The `PlatformID` property values of all platforms in the scenario are renumbered in a numeric sequence in the app.
- The app only supports the `fusionRadarSensor` and `monostaticRadarSensor` objects and ignores other sensor objects (such as the `irSensor` object and the `sonarSensor` object) in the scenario. When specifying a `fusionRadarSensor` object in the imported tracking scenario, you must set the `DetectionMode` as `'Monostatic'` and set the `TargetReportFormat` property as `'Detections'` or `'Clustered Detections'`.

- The app ignores all emitter objects, such as `radarEmitter` and `sonarEmitter` objects.

Tips

- The app uses the NED frame as the default coordinate frame, in which a platform with positive altitude has negative z coordinate.
- You can undo (press **Ctrl+Z**) and redo (press **Ctrl+Y**) changes you make on the scenario and sensor canvases. For example, you can use these keyboard shortcuts to delete a recently placed road center or redo the movement of a radar sensor.
- You can use the **Space** bar on the keyboard to reset the Platform Canvas to a view containing all platforms and trajectories.
- You can use the **Enter** and **Esc** keys on the keyboard to accept and cancel a waypoint, respectively.

Compatibility Considerations

radarSensor System object is not recommended

The **Tracking Scenario Designer** app uses the `fusionRadarSensor` System object as the internal model for radar sensors. Starting from R2021a, `radarSensor` and `monostaticRadarSensor` System objects are not recommended, and the app stops using the `monostaticRadarSensor` System object as the internal model.

In addition to the new `fusionRadarSensor` object, you can still import `radarSensor` and `monostaticRadarSensor` objects into the **Tracking Scenario Designer** app. Also, when you export a scenario containing `radarSensor` and `monostaticRadarSensor` objects to MATLAB code, the app exports the sensors as `fusionRadarSensor` objects.

See Also

Objects

`Platform` | `fusionRadarSensor` | `rccSignature` | `trackingScenario` | `waypointTrajectory`

Topics

“Design and Simulate Tracking Scenario with Tracking Scenario Designer”

Introduced in R2020a